



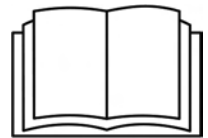
An Oshkosh Corporation Company

---

# Operator, Safety, Maintenance and service Manual

Original Instructions - Keep this manual with the machine at all times

## Boom Lift Models X20JPLUS



*MUX20JP021602*  
*2016, revision02*

---



## Table of contents

1.	Preface .....	Pag. 8
1.1.	Attention - danger .....	Pag. 8
1.2.	Warning .....	Pag. 8
1.3.	Note .....	Pag. 8
2.	How to use the manual .....	Pag. 9
3.	Normative reference .....	Pag. 11
4.	Warranty .....	Pag. 12
5.	Liability .....	Pag. 13
6.	EC Declaration Conformity .....	Pag. 14
7.	Technical informations .....	Pag. 16
7.1.	Description of the machine .....	Pag. 16
7.2.	Machine identification plate .....	Pag. 17
7.3.	Overall dimensions of the machine .....	Pag. 18
7.4.	Technical data .....	Pag. 19
7.4.1.	Technical data petrol engine .....	Pag. 20
7.4.2.	Technical data Diesel engine .....	Pag. 20
7.4.3.	Hydraulic system technical specifications.....	Pag. 21
7.4.4.	Electrical system technical specifications thermal engine.....	Pag. 21
7.4.5.	Electrical system technical specifications lithium .....	Pag. 21
7.5.	Terminology .....	Pag. 23
7.6.	General safety standards.....	Pag. 25
7.7.	Clothing and protective equipment .....	Pag. 26
7.8.	Safety valves and electrical system safety components.....	Pag. 26
7.9.	Fire prevention .....	Pag. 27
7.10.	Preventing damage caused by washing the machine.....	Pag. 27
7.10.1.	Cleaning the machine .....	Pag. 27
7.10.2.	Washing the outside of the machine .....	Pag. 28
7.10.3.	Cleaning the electrical system .....	Pag. 28
7.10.4.	After cleaning.....	Pag. 28
7.11.	Preventing damage that may be caused by the machine during work..... Pag. 29	
7.12.	Safety warnings .....	Pag. 30

---

7.12.1.	Generalities .....	Pag. 30
7.12.2.	Noise and Vibration.....	Pag. 30
7.12.3.	Decals on the machine.....	Pag. 31
8.	Safety device .....	Pag. 41
8.1.	Battery cut-out switch.....	Pag. 42
8.2.	Distributor pressure relief valves .....	Pag. 42
8.3.	Cylinder stop valves .....	Pag. 43
8.4.	Alignment photocells of the aerial part .....	Pag. 44
8.5.	Stabilizer position micro switches .....	Pag. 44
8.6.	JIB position micro switch .....	Pag. 45
8.7.	Ropes integrity micro switch.....	Pag. 45
8.8.	Basket load sensor.....	Pag. 47
8.9.	Control protection.....	Pag. 49
8.10.	Spirit and electronic level.....	Pag. 50
8.11.	Pin locking bolts and nuts.....	Pag. 51
8.12.	Safety device electronic control board .....	Pag. 52
8.13.	Booms position sensors .....	Pag. 52
8.14.	External temperature sensor (optional) .....	Pag. 53
9.	Instruments and controls .....	Pag. 54
9.1.	Remote control.....	Pag. 54
9.1.1.	Display .....	Pag. 55
9.1.2.	Joystick.....	Pag. 59
9.1.3.	Push buttons .....	Pag. 61
9.2.	Foot switch (optional).....	Pag. 64
9.3.	Control position.....	Pag. 65
9.3.1.	Control position in the basket .....	Pag. 65
9.3.2.	Control position at the ground.....	Pag. 65
9.3.3.	Emergency control position.....	Pag. 66
9.3.4.	Maintenance control position.....	Pag. 67
9.4.	Remote Control MOVE (optional).....	Pag. 69
9.5.	SkyGuard™ system (optional).....	Pag. 69
10.	Emergency device .....	Pag. 71
10.1.	Emergency stop button .....	Pag. 71
10.2.	Hand pump.....	Pag. 72
10.3.	Solenoid valves for emergency descent.....	Pag. 73
10.4.	Safety device bypass key.....	Pag. 73
10.5.	Emergency position controls .....	Pag. 74



10.5.1.	Selection panel, emergency stop and starting.....	Pag. 74
10.5.2.	Aerial part hydraulic distributor .....	Pag. 76
10.5.3.	Tracked undercarriage hydraulic distributor .....	Pag. 79
11.	Using the machine .....	Pag. 82
11.1.	Safety standards to adopt before using the platform.....	Pag. 82
11.1.1.	Risk of electrocution .....	Pag. 82
11.1.2.	Danger due to atmospheric conditions.....	Pag. 82
11.1.3.	Danger due to the work area.....	Pag. 84
11.2.	Procedures for correct use.....	Pag. 84
11.2.1.	Summary table of operator safety standards .....	Pag. 85
11.3.	Working area.....	Pag. 87
11.4.	Use of the elevating work platform (MEWP).....	Pag. 88
11.4.1.	Preliminary checks before starting work.....	Pag. 89
11.4.2.	Starting the Petrol/Diesel engine.....	Pag. 89
11.4.3.	Starting the electric motor.....	Pag. 91
11.4.4.	Stopping the engine/motor .....	Pag. 93
11.4.5.	Stopping the motor Lithium version.....	Pag. 93
11.4.6.	Travel .....	Pag. 94
11.4.7.	JIB boom movement for travel .....	Pag. 96
11.4.8.	Parking the machine on a slope or on uneven ground.....	Pag. 98
11.4.9.	Stabilising and levelling the machine.....	Pag. 98
11.4.10.	Automatic lowering and raising of the stabilisers .....	Pag. 102
11.4.11.	Track extension.....	Pag. 104
11.4.12.	Moving the basket.....	Pag. 106
11.4.13.	Manually levelling of the basket.....	Pag. 109
11.5.	Aerial part emergency manoeuvres .....	Pag. 112
11.5.1.	Activation of emergency descent from the basket .....	Pag. 112
11.5.2.	Operating the machine from the emergency control position on the ground if the operator is taken ill .....	Pag. 114
11.5.3.	Emergency descent in the case where the stabilisers are accidentally retracted.....	Pag. 117
11.5.4.	Emergency descent controlled from the ground using the hand pump in the event of faults on all energy supply systems.....	Pag. 120
11.5.5.	Emergency operation of the undercarriage in the event of movements of the aerial part.....	Pag. 124
11.5.5.1.	Machine realignment.....	Pag. 124
11.5.5.2.	Moving the undercarriage with the machine not aligned.....	Pag. 125
11.5.6.	Emergency operations on the carriage: moving the platform stabilisers using the hand pump to allow the machine to be transported ....	Pag. 128

11.6.	Electrical connection of remote control.....	Pag. 131
11.7.	Recharging the battery .....	Pag. 132
11.7.1.	Battery charging Petrol/Diesel engine.....	Pag. 132
11.7.2.	Charging Lithium batteries.....	Pag. 133
11.8.	Main intended uses of the platform .....	Pag. 137
11.8.1.	Systems .....	Pag. 137
11.8.2.	Closed environments .....	Pag. 137
11.8.3.	Pruning .....	Pag. 137
11.8.4.	Repair and maintenance of roofing and gutters.....	Pag. 137
11.8.5.	Painting, sand-blasting and plastering .....	Pag. 138
11.8.6.	Use in marine environments .....	Pag. 138
12.	Maintenance .....	Pag. 139
12.1.	Safety instructions for greasing and lubrication.....	Pag. 139
12.1.1.	Table of recommended lbrificants .....	Pag. 139
12.1.2.	Greasing points.....	Pag. 142
12.1.3.	Greasing the telescopic boom.....	Pag. 142
12.2.	Safety instructions for maintenance operations .....	Pag. 143
12.3.	Maintenance control position with remote control from the ground	Pag. 144
12.4.	Periodical maintenance intervals.....	Pag. 147
12.5.	Electric motor maintenance .....	Pag. 150
12.6.	Inspection and maintenance intervals .....	Pag. 152
12.6.1.	A- Daily inspections before starting.....	Pag. 152
12.6.2.	B- Periodical inspections .....	Pag. 152
12.6.3.	C- Annual inspections .....	Pag. 153
12.6.4.	D- Structural inspection .....	Pag. 154
12.6.5.	E- Maintenance .....	Pag. 154
12.7.	General periodical checks .....	Pag. 155
12.8.	Maintenance on rubber tracks.....	Pag. 156
12.8.1.	Rubber tracks tension check .....	Pag. 156
12.8.2.	Tensioning rubber track .....	Pag. 157
12.8.3.	Removing rubber track.....	Pag. 157
12.8.4.	Installing rubber track .....	Pag. 159
12.9.	Checking tightness of nuts and bolts .....	Pag. 159
12.10.	Hydraulic oil level check.....	Pag. 164
12.11.	Checking for leaks in the hydraulic system .....	Pag. 164
12.12.	Checking the condition of the filter cartridge.....	Pag. 164
12.13.	Checking that all the plates are present on the machine and intact ...	Pag. 165

12.14.	Checking the operating pressures in the hydraulic system.....	Pag. 166
12.15.	Checking extension ropes .....	Pag. 168
12.15.1.	Checking wear and deformation of ropes and pulleys .....	Pag. 168
12.15.2.	Three-monthly inspection.....	Pag. 169
12.15.3.	Ropes Tension Adjustment Procedure.....	Pag. 170
12.15.4.	Five-yearly inspection .....	Pag. 171
12.16.	Checking wear of the telescopic arm slide blocks .....	Pag. 172
12.17.	Battery Petrol/Diesel engine: maintenance - replacement - disposal .Pag. 173	
12.18.	Battery pack maintenance operating specifications.....	Pag. 175
12.18.1.	Handling in dangerous conditions.....	Pag. 176
12.18.1.1.	Personal protective equipment .....	Pag. 176
12.18.1.2.	Procedure for handling hot cells.....	Pag. 176
12.18.1.3.	Procedure for handling vented cells .....	Pag. 177
12.18.1.4.	Procedure for exploded cells.....	Pag. 179
12.18.1.5.	Lithium battery fire.....	Pag. 180
12.19.	Servicing the engine thermic version .....	Pag. 182
12.20.	Start-up of the machine after maintenance .....	Pag. 182
13.	Safety standards for transport .....	Pag. 183
13.1.	Removing the basket.....	Pag. 183
13.2.	Loading and unloading the machine on transport vehicles using ramps Pag. 185	
13.3.	Lifting the machine .....	Pag. 187
13.3.1.	Lifting the machine using a forklift .....	Pag. 187
13.3.2.	Lifting the machine using ropes or chains.....	Pag. 189
13.4.	Transporting the machine.....	Pag. 191
14.	Service menu on the remote control .....	Pag. 192
14.1.	Input menu.....	Pag. 192
14.2.	Language menù .....	Pag. 192
14.3.	Errors menu .....	Pag. 192
14.4.	Working hours menu.....	Pag. 193
14.5.	Joystick menu.....	Pag. 193
15.	Hydraulic system .....	Pag. 194
16.	Wiring diagram .....	Pag. 197



JLG Industries, Inc.

13224 Fountainhead Plaza

Hagerstown, MD 21742

or Your Local JLG Office

"Worldwide locations (p. 202)"

**In USA:**

Toll Free: 877-JLG-SAFE (877-554-7233)

**Outside USA:**

Phone.: 240-420-2661

Fax: 301-745-3713

E-mail: ProductSafety@JLG.com

**For:**

- Accident Reporting
- Product Safety Publications
- Current Owner Updates
- Questions Regarding Product Safety
- Standards and Regulations Compliance Information
- Questions Regarding Special Product Applications
- Questions Regarding Product Modifications

## 1. PREFACE

The aim of this manual is to provide the user with the necessary instructions and essential operating procedures to ensure correct and safe use of the machine for its intended purposes, as well as to prevent serious injury to the operator and other persons.

This manual describes the warning signs used to draw the reader's attention to several particularly important warnings. The safety warnings are divided into three main types, which are identified and described below.

### 1.1. ATTENTION - DANGER



*This symbol indicates that the situation described, if not prevented, can lead to serious injury or death of the persons involved (operator, ground staff, staff present in proximity to the machine, maintenance technicians etc.).*

### 1.2. WARNING



*This symbol indicates that the situation described represents a potential risk for the structure of the machine. Dangerous situations may be determined by this condition (including injury or death) for the persons involved.*

### 1.3. NOTE



*This symbol indicates tips or additional notes useful for the operator or for those who must perform maintenance/repair on the machine.*

---

Original languages of the manufacturer: Italian and English. All other languages are copies of the original instructions.

## 2. HOW TO USE THE MANUAL

**It is mandatory to keep to all the instructions given in this manual. This manual must be carefully read and understood before operating the machine.**

As this manual is an essential work tool, it must be kept with the machine at all times, in the special compartment, so as to be available for clarification whenever required.



**Fig. 1** *Position of manual on machine*

As the manufacturer cannot control the conditions of the machine and the operations this is used for, **the user is responsible** for ensuring compliance with the safety procedures described in this manual.

Every machine supplied is thoroughly adjusted and tested before being delivered. The operator does not need to perform any adjustments before using the machine. Every alteration and/or modification of the features of the original machine design without previous written authorization from the constructor are prohibited and the responsibility for these actions falls on the operator.

**The employer must make sure that the operator has the requisites necessary to operate the machine correctly and that such operator has carefully examined and understood the information given in this user and operation manual, receiving suitable training regarding use of the machine in standard and emergency conditions.**

**The employer must also train operators regarding any national standards that are in addition to the instructions contained in this document.**

If the manual is damaged or lost, a copy must be requested directly from the manufacturer.



*All of the photos and drawings in this manual have been added to simplify comprehension by the reader. Your machine may differ from the photos and drawings provided.*



### 3. NORMATIVE REFERENCE

The machine has been designed, built and inspected according to that prescribed in the EN280 harmonised standard, which supplies the presumption of conformity with the Essential Safety Requisites of the 2006/42/CE Machinery Directive even if a type C Voluntary Technical Standard.

According to that stated in EN280, the platform is classified in GROUP B, as the vertical projection of the centre of gravity of the load can be outside of the tilting lines and in TYPE 1 as traversing is only allowed with the platform at rest.

The stability tests of the machine have been made in accordance with what described in the EN280 and have been successful.

In addition what prescribed in this manual it is necessary to apply the technical requirements of the following national/international safety standards:

- UNI ISO 18893
- ISO 16368
- ISO 18878

With the exception of stricter local or national regulations in the working area of the MEWP.

**4. WARRANTY**

On purchasing a machine, a warranty and inspection certificate is issued that clearly indicates the warranty terms and where any interventions on the machine must be reported.

## 5. LIABILITY

The Constructor is exonerated from any liability and obligation for any injury/damage caused to persons/objects due to any of the reasons listed below:

- Failure to comply with the instructions indicated in this USE AND MAINTENANCE MANUAL regarding running, use and maintenance of the machine;
- Violent or sudden actions or incorrect manoeuvres when using or servicing the machine;
- Modifications made to the structure or machine components without previous authorisation from the Constructor and/or without the use of suitable equipment;
- Strange events with respect to normal and correct use of the machine, described in this USE AND MAINTENANCE MANUAL;
- Use of non-original spare parts not authorised by the manufacturer;

## 6. EC DECLARATION CONFORMITY



Manufacturer: JLG Industries Inc.  
 Address: 1 JLG Drive  
 McConnellsburg  
 PA 17233  
 USA

Technical File: JLG Industries Inc.  
 JLG Technology & Development Centre  
 Bruntingthorpe Aerodrome & Proving Ground  
 Lutterworth, Leicestershire  
 LE17 5QS  
 United Kingdom.

Contact: Barrie Lindsay Position: Director of Engineering-Europe

Machine Type: Mobile Elevating Work Platform

Model Type:

Serial Number:

Notified Body: ECO Certificazioni S.p.A  
 EC-Number: 0714  
 Address: Via Mengollina  
 33 - 48108  
 Faenza  
 Italy

Certificate Number: \_\_\_\_\_

Reference Standards: EN ISO 12100:2010  
 EN 280:2013

JLG Industries Inc. hereby declares that the above mentioned machine conforms with the requirements of:

2004/108/EC EMC Directive  
 2006/42/EC Machinery Directive

Signed: \_\_\_\_\_  
 Name: Barrie Lindsay

Date: \_\_\_\_\_  
 Position: Director of Engineering-Europe  
 Place: Bruntingthorpe, UK

Remark:

This declaration conforms with the requirements of annex II-A of the council directive 2006/42/EC  
 Any modification to the above described machine violates the validity of this declaration.  
 Machine manufactured for JLG Industries Inc. by HINOWA S.p.a via Fontana 37054 NOGARA VR Italy

**Fig. 2** EC Declaration Conformity

**JLG** EC DECLARATION OF CONFORMITY

Manufacturer: JLG Industries Inc.  
 Address: 1 JLG Drive  
 McConnellsburg  
 PA 17233  
 USA

Machine Type: Mobile Elevating Work Platform

Model Type:

Serial Number:

Document Control: HINOWA S.p.A  
 Via Fontana - 37054  
 Nogara  
 Italy

Technical File: JLG Industries Inc.  
 JLG Technology &  
 Development Centre  
 Bruntingthorpe  
 Aerodrome & Proving  
 Ground  
 Lutterworth,  
 Leicestershire  
 LE17 5QS  
 United Kingdom.

Measured  
 Lwa dB(A)

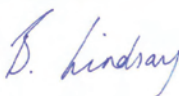
Guaranteed  
 Lwa dB(A)

Engine Power: kW

Lwa	= (Sound Power Level)
-----	-----------------------

Applicable Procedure: EN ISO 3744:1995  
 Applicable Directive: 2000/14/EC Annex V Internal Control of Production.

We hereby declare that the above mentioned machine conforms with the requirements of the "Noise Emission in the Environment by Equipment for Use Outdoors" Directive 2000/14/EC as amended by 2005/88/EC



Signed: \_\_\_\_\_ Date: \_\_\_\_\_  
 Name: Barrie Lindsay Position: Director of Engineering-Europe  
 Place: Bruntingthorpe, UK

Remark:  
 Any modification to the above described machine violates the validity of this declaration.  
 Machine manufactured for JLG Industries Inc. by HINOWA S.p.a via Fontana 37054 NOGARA  
 VR Italy

**Fig. 3** EC Declaration Conformity

## 7. TECHNICAL INFORMATION

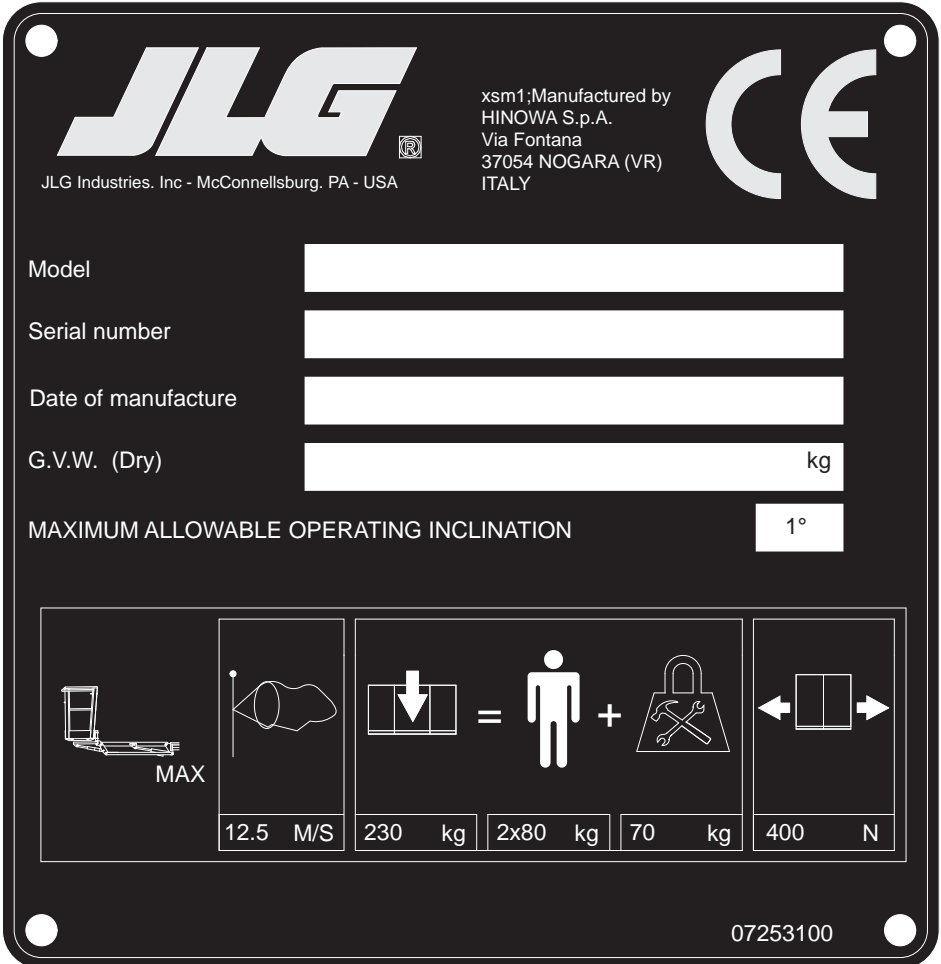
### 7.1. DESCRIPTION OF THE MACHINE

The machine is a self-propelled hydraulic lifting device, equipped with a rotating work basket positioned at the top of an extensible articulated structure, which also rotates. The lifting device is destined for the positioning of persons and their equipment and materials in high positions with respect to ground level.

**Refer to relevant paragraph in respect of the control stations "Control position (p. 65)"**

**7.2. MACHINE IDENTIFICATION PLATE**

The manufacturer plate is placed on the protection of the aerial part hydraulic distributor or on the machine frame near of the lifting forks fasteners.



**Fig. 4** Example CE plate

7.3. OVERALL DIMENSIONS OF THE MACHINE

Maximum length in travel configuration with basket installed	5011 mm
Track width closed/open	795/1095 mm
Maximum height in travel configuration with foot plates removed	1998 mm
Maximum attachment angle	20° / 21°
Maximum stabilisation angle	15°
Max stabiliser base side (disc centre)	2922x2925 mm

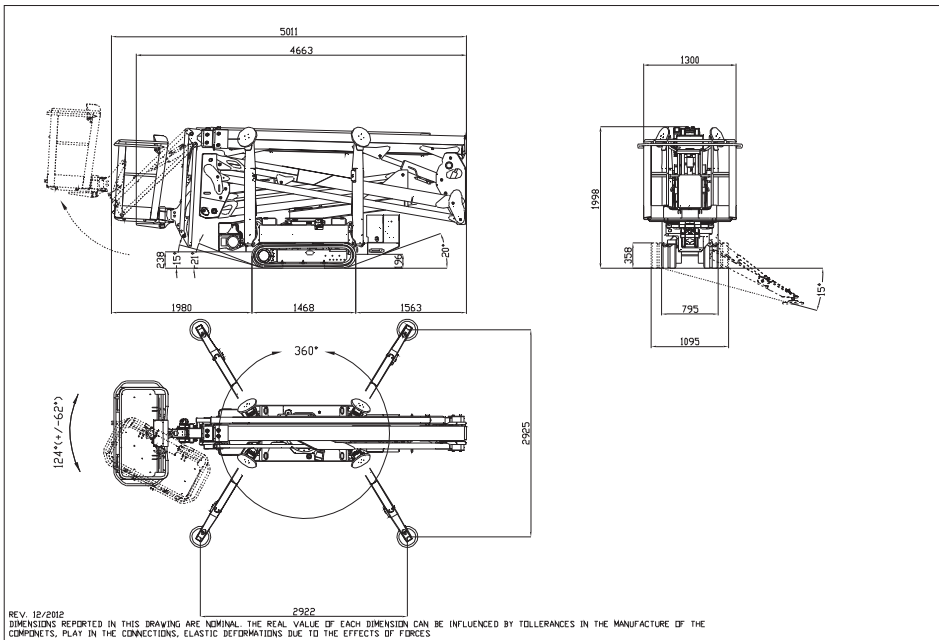


Fig. 5 Standard version with 2 person basket



## 7.4. TECHNICAL DATA

Platform capacity	230 Kg
Platform height (floor)	18.05m
Max working height	20.15m
Standard basket dimensions	1335x690xH1100mm
Max horizontal extension in basket	9.20m
Max horizontal outreach	9.70m
Rotation (non-continuous)	360°
Basket rotation	124° (+/- 62°)
Max ground reaction force for each stabilizer	2150 daN
Max ground pressure for each stabilizer	3.04 daN/cm <sup>2</sup>
No. Of operators	2
No. Of operators with optional single-operator basket	1
JIB - type of articulated joint	89° (+0° / -89°)
Max working gradient	1°/ 1,75%
Max stabilization slope	15°
Total weight in transport configuration petrol engine	2840Kg
Total weight in transport configuration diesel	2940Kg
Total weight in transport configuration lithium	2950Kg
Electrical system voltage	12V
Max translation speed with standard 2nd speed (thermic motor)	0,5/1,3/2,5 Km/h
Max translation speed with standard 2nd speed (lithium)	0,83/1,6 Km/h
Travel/stab. System pressure	165bar
Aerial part system pressure	210bar

Approach angle	20° / 21°
Max slope allowed in travel direction	16° / 28,7%
Max wind speed	12,5 m/s
Max manual force allowed	400N

**7.4.1. Technical data petrol engine**

Make/Model	HONDA iGX440
Fuel/Cooling	Petrol / Air
Power	9,5 Kw (12,7cv) / 3600rpm
Max speed	3600 rpm
Maximum torque	29,8 Nm / 2500rpm
Number of cylinders	1
Displacement	440 cm <sup>3</sup>
Sound power level at operator's ear	88 dB
Measured sound power level	102 dB
Granted sound power level	104 dB

**7.4.2. Technical data Diesel engine**

Make/Model	PERKINS 402.05
Fuel/Cooling	Diesel / Liquid
Power	10,2 kW (14cv) / 3600rpm
Max speed	3500 rpm
Maximum torque	29,7 Nm / 2400rpm
Number of cylinders	2
Displacement	510 cm <sup>3</sup>
Sound power level at operator's ear	90 dB
Measured sound power level	102 dB

Granted sound power level	104 dB
---------------------------	--------

#### 7.4.3. Hydraulic system technical specifications

Hydraulic oil tank capacity	40 l
Pump petrol engine	2x4 cm <sup>3</sup>
Pump diesel engine	2x4 cm <sup>3</sup>
Hydraulic system max pressure	220 bar

For further information, see the hydraulic diagram enclosed with the manual and the paragraph on maintenance of the hydraulic components.

#### 7.4.4. Electrical system technical specifications thermal engine

Battery	55-60Ah - 240-680A - 12V
Alternator petrol engine	20 A (3600rpm)
Alternator Diesel engine	14-15 A (3600rpm)
Electric motor rated voltage	230V - 110V - 120V
Electric motor frequency	50Hz - 50Hz - 60Hz
Electric motor rated power	2,2 kW - 2,2 kW - 1,2 kW

For further information, see wiring diagram enclosed with the manual and the paragraph on maintenance of electrical components.

#### 7.4.5. Electrical system technical specifications lithium

Battery	90-100 Ah
Electric motor rated voltage	72 V
Electric motor rated power	3,5 kW
Onboard battery charger	220V+30V 50-60 Hz
	110V+30V 50-60 Hz
Full weight of the battery pack	180 Kg

---

Sound power level at operator's ear	70 dB
Measured sound power level	86 dB
Granted sound power level	88 dB

For further information, see wiring diagram enclosed with the manual and the paragraph on maintenance of electrical components.

7.5. TERMINOLOGY

To make the contents of this manual easier to understand, the diagram provided below illustrates the terms used to identify the parts of the machine.

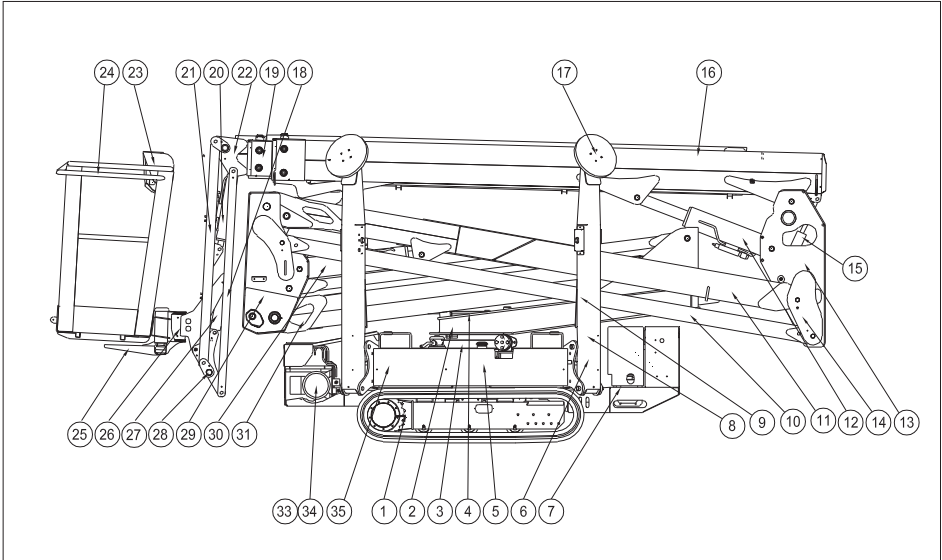


Fig. 6 Terminology machine components

LEGENDA

1	Tracked undercarriage
2	Revolving turret
3	Turntable + rotation motor
4	Emergency controls
5	Base+electrical component compartment+oil tank
6	Double gear pump
7	Petrol/diesel engine / Battery pack + inverter + battery charger (LITHIUM MOTOR)
8	Stabilizer

9	Stabilizer cylinder
10	Second arm tie rod
11	Second arm
12	Second-third arm cylinder
13	Second-third arm transmission
14	Second-third arm connecting rod
15	Basket levelling cylinder on the transmission
16	Third arm
17	Stabilizer plate
18	JIB tie rod
19	First extension arm
20	Jib cylinder
21	Right and left JIB arm
22	Second extension arm
23	Remote control
24	Basket or cage
25	Basket support
26	Rotary actuator for basket rotation
27	Basket levelling cylinder on the basket
28	JIB transmission
29	First-second arm transmission
30	First-second arm cylinder
31	First arm
32	
33	Electric motor
34	Double gear pump
35	Emergency hand pump

## 7.6. GENERAL SAFETY STANDARDS



*Warning*

The functioning of the MEWP must be in compliance with international standards of reference see "Normative reference (p. 11)", and national or regional standards if stricter. The operator must read, understand and follow all the instructions and warnings, contained in this manual and on the machine, regarding the safe use of the MEWP.



*Attention - danger*

FAILURE TO COMPLY WITH THE SAFETY PRECAUTIONS LISTED IN THIS SECTION AND PROVIDED ON THE MACHINE CAN DAMAGE THE MACHINE AND CAUSE INJURY OR EVEN DEATH, AND CONSTITUTES A SERIOUS BREACH OF THE SAFETY RULES.

This section of the USER AND OPERATION MANUAL describes those procedures or dangerous situations that can cause damage/injury to objects/persons and explains what the operator must do to prevent them.

- Operators must always act professionally, complying with safety standards, making sure not to underestimate their responsibility to themselves and the surrounding objects and persons.
- **Before starting work, operators must receive complete and clear training regarding the use of the machine in standard and emergency conditions.**
- **They must examine, understand and take in all the instructions given in this user manual. They must be sure that the safety devices are in perfect working order, perform the necessary checks on the machine and be familiar with the conditions of the ground on which the machine is going to be operated and stabilised.**
- The presence of at least one specialist operator is necessary on the ground during work. This person must know how to use the machine, be aware of the contents of the USER AND OPERATION MANUAL and be able to intervene if necessary.

- It is prohibited to make modifications to the machine that could jeopardise functioning and safety, without previous written authorisation from The Constructor which is not liable for any injury or damage caused by this behaviour.

### 7.7. CLOTHING AND PROTECTIVE EQUIPMENT



Avoid wearing loose clothing, rings, watches or anything else that may get caught in moving parts. When using the machine or performing maintenance, wear a hard hat, glasses, safety footwear, gloves and acoustic earmuffs after making sure these and all other PPE that the safety manager considers necessary based on the risk analysis performed are in perfect working condition.



*Warning*

USE THE TYPE-APPROVED AND CERTIFIED SAFETY HARNESSSES. BEFORE WORKING AT A HEIGHT, MAKE SURE THAT THE SAFETY HARNESSSES ARE CORRECTLY FASTENED AND CONNECTED TO THE ANCHORAGE POINTS ON THE BASKET.

THE USE OF HARNESSSES IS COMPULSORY IN ACCORDANCE WITH LOCAL LEGISLATION IN EACH INDIVIDUAL COUNTRY. IN COUNTRIES WHERE THE LAW DOES NOT REQUIRE THE USE OF SUCH SAFETY SYSTEMS, THE EMPLOYER AND/OR USER IS RESPONSIBLE FOR CHOOSING THE SYSTEM TO BE USED.

### 7.8. SAFETY VALVES AND ELECTRICAL SYSTEM SAFETY COMPONENTS

**It is prohibited to modify and/or tamper with the safety and control valves of the main hydraulic system and the adjustments of the electric plant. The Constructor is not liable for injury to persons and damage to objects or to the machine if the standard calibration of any hydraulic and electric/electronic component is tampered with.**

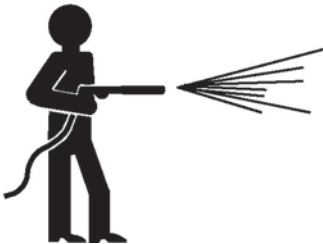


## 7.9. FIRE PREVENTION



Keep the area around the motor clean, removing fragments of wood, paper and other flammable products; clean any fuel leaks as these may be a potential cause of fire. Petrol is extremely flammable and explosive in particular conditions. Refuel in well ventilated areas and with the engine at rest. Avoid smoking and producing sparks in the refuelling and fuel storage area. After refuelling, make sure to put back the cap correctly. Take care to avoid touching the exhaust silencer when this is hot, i.e. with the machine running or soon after stopping the engine.

## 7.10. PREVENTING DAMAGE CAUSED BY WASHING THE MACHINE



Do not direct high pressure jets towards the electrical components while washing the machine. Do not use chemical detergents or petrol that would damage the plastic parts and the painting.

BEFORE WASHING THE MACHINE, ALWAYS REMEMBER TO REMOVE THE REMOTE CONTROL AND CORRECTLY CLOSE THE REMOTE CONTROL AND EQUIPMENT CONNECTION SOCKETS LOCATED ON THE MACHINE.

### 7.10.1. *Cleaning the machine*



*When washing the machine, the ignition block must be disengaged, the key removed and the emergency stop button pressed.*



### 7.10.2. Washing the outside of the machine

Always park the machine as shown in the figure "Terminology (p. 23)"

Never use flammable liquids.

Clean the machine using water-soluble detergents. Follow the instructions provided by the manufacturer of the detergent.

Do not remove protective covers and casings of any kind.



If washing the machine with water cleaners, do not aim the spray directly onto adhesive labels and rating plates. Carefully protect all the important parts and above all the electrical components.



*The more the elevating platform is cleaned, the more it will need to be greased*

### 7.10.3. Cleaning the electrical system



*Never clean the electric components with water, as this may cause damage to the electrical system of the machine.*



Only use dry detergents, in accordance with the manufacturer's instructions. Never remove covers, guards and the like.

### 7.10.4. After cleaning

Dry the machine carefully before starting it again (for example using compressed air).



*If, despite all the precautions, moisture has penetrated into the electric motor or other parts of the electric system, these must be dried before starting the machine.*

### **7.11.PREVENTING DAMAGE THAT MAY BE CAUSED BY THE MACHINE DURING WORK**

When the machine has been stabilised and work has started, never enter its operating area.

Always operate the controls slowly and smoothly and avoid reversing the movements suddenly.

When operating outside of the basket, ALWAYS keep a MINIMUM distance of 1 METRE from the machine.

## 7.12.SAFETY WARNINGS

### 7.12.1. Generalities



To avoid accidents, before starting work and before performing any maintenance operations, it is necessary to read, understand and follow all the precautions and warnings contained in this manual. The user/operator of the machine must decline all responsibility for operation until having read this manual and fully understood how to use the machine under the supervision of an expert and qualified operator.

Carefully read all the safety messages provided in this manual and the safety signs on the machine. Keep the safety signs in good condition and replace them if they are damaged. Make sure that any new components on the machine are provided with the correct safety signs.

### 7.12.2.Noise and Vibration

The Constructor declares that the platforms have been tested according to the parameters of European directive 2000/14 EC, with the guaranteed sound power level measurement shown on the machine's EC declaration of conformity. When operating the aerial part of the machine, this value is reduced even further as the basket moves away from the main source of noise. The vibrations transmitted to the operator from the controls and directly from the floor of the basket are lower than the maximum allowed limits 0,5 m/s<sup>2</sup>.

7.12.3. Decals on the machine

Here we report the positions of the various boards with pictogram on the machine.

52

40 42

21 36 35 39 34 22 31 11

21 27 41 5 33

29 47 7 46 28

49 14 23

12 18 18 12 19 13 12 6

24 10 48 24 2

12 20 13 18 12 41 5

11 1 24 10 48 24 2

L2 16 L3 L2 6

L1 11 43

L4

9

KIT ADESIVI - X20PLUS	AUFKLEBERSATZ - X20PLUS	<b>cod. 17351800</b>
SET OF DECALS - X20PLUS	KIT ADHESIVOS - X20PLUS	
KIT COLLANTS - X20PLUS	ADHESIEKIT - X20PLUS	Ed. 20/06/2014 Tav 01





	<p>22 34 35 37</p>	<p>AUFKLEBERSATZ-- X20JPLUS KIT ADHESIVOS -- X20JPLUS ADHESIEKIT -- X20JPLUS</p>	<p><b>cod. 17351800</b></p>
	<p>38 50 54 11 51</p>	<p>KIT ADESIVI - X20JPLUS SET OF DECALS -- X20JPLUS KIT COLLANTS -- X20JPLUS</p>	<p>Ed. 20/06/2014   Tav 03</p>

Position	Code	Quantity		Position	Code	Quantity
01	06555500	01		31	1701504	01
02	06555600	01		32	06164700	01
03	06555700	01		33	06165000	01
04	06555800	01		34	06060000	01
05	06041200	04		35	06227200	01
06	100112548 3	06		36	1701542	01
07	1706898	01		36	1701505	01
08	06924300	01		37	06056300	01
09	1706493	01		38	06164600	01
10	06040500	02		39	06232100	01
11	06040900	06		40	07240300	01
12	06041300	11		41	07320400	04
13	1703814	04		42	07034200	02
14	06044000	04		43	07397200	01
15				44	160871000 1	01
16	1704277	02		45	160871000 2	01
17	1705828	01		46	07199100	01
18	07056700	06		47	06254800	01
19	1701499	02		48	06922700	02
20	07058800	02		49	07350300	04
21	06040300	04		50	06214200	01
22	1706098	01		51	06594500	01
23	07349200	01		52	07071000	01



Position	Code	Quantity		Position	Code	Quantity
24	07056800	03		53	06136900	01
25	06086000	01		54	07508200	01
26	06085900	01				
27	06706500	01				
28	06998800	01				
29	07242000	01				
30	1702155	01				

### Language decals

Position	Code	Quantity		Position	Code	Quantity
	172831IT				172831GB	
L1	06555300	01		L1	06562600	01
L2	06561200	04		L2	06561200	04
L3	06448200	02		L3	06462700	02
L4	06448100	02		L4	06462100	02
L5	07348900	01		L5	073489GB	01
	172831FR				172831DE	
L1	06562700	01		L1	06562800	01
L2	06561200	04		L2	06561200	04
L3	06462800	02		L3	06462900	02
L4	06462200	02		L4	06462300	02
L5	073489FR	01		L5	073489DE	01
	172831ES				172831NL	

Position	Code	Quantity		Position	Code	Quantity
L1	06562900	01		L1	06563000	01
L2	06561200	04		L2	06561200	04
L3	06463000	02		L3	06463100	02
L4	06462400	02		L4	06462500	02
L5	073489ES	01		L5	073489NL	01
	172831PT				172831DA	
L1	06563100	01		L1	07138100	01
L2	06561200	04		L2	06561200	04
L3	06463200	02		L3	07138000	02
L4	06462600	02		L4	07137900	02
L5	073489PT	01		L5	073489DA	01
	172831NO				172831SW	
L1	07162000	01		L1	07137300	01
L2	06561200	04		L2	06561200	04
L3	07161800	02		L3	07137500	02
L4	07161900	02		L4	07137400	02
L5	073489NO	01		L5	073489SW	01

## Decals description



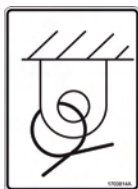
Warning keep safe distance



Sense of moving undercarriage defined as the direction forward.



Obligation to read the manual before use of machine.



Fixing point for transport indicates correct fixing point for transport of the machine.



Crushing hazard feet indicates areas where there is a danger of crushing lower limbs for the operator.



Crushing hazard person indicates areas where there is a danger of crushing upper limbs for the operator.



Lifting point indicates correct lifting points for lift the machine.



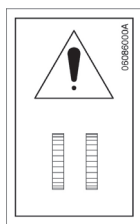
Danger high temperature.



Engine oil level.



Emergency device for aerial part device that allows to exclude the safety of the aerial part in case of emergency operations.



Emergency device for undercarriage device that allows to exclude the safety of the undercarriage in case of emergency operations.



Hydraulic oil level.



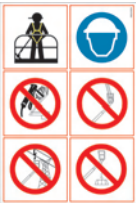
Forbidden lifting point.



Do not wash with water.



Hand pump legend quick instructions for using the emergency hand pump.



Use safety harnesses, use protective equipment (helmet), prohibition of weld on the machine, prohibition of use systems to increase the area of work inside the basket, prohibition of working in the vicinity of voltage electric, prohibition of use of the platform for raising loads.



Battery pack warnings.

Corrosive liquid, presence of highly corrosive liquid, dangerous to the body and eyes.

High voltage, presence of high voltage with danger of electric shock.

Danger of explosion, formation of potentially explosive mixture inside the battery.

No naked flames, do not smoke or use naked flames when recharging and near the vehicle. Risk of explosion.

Recycling, it is highly recommended to comply with legislative and environmental standards as regards the demolition, reuse, recycling and recovery of materials.



Lifting points with forklift, indicates the lifting points with forklift.



*Replace stickers and plates if there is any sign of wear.*



*Failure to heed any warnings due to a safety sticker being damaged, lost or ignored may cause serious accidents.*



Anchor position in basket indicates the position of the anchor hooks to which fasten the operator's safety sling.

## 8. SAFETY DEVICE

The information given below concerning the safety devices are provided to the user in order to allow him/her to understand the machine behaviour and possible work sequences; moreover, in this way it is possible to identify any breakdowns with greater precision and to supply more detailed information to the after sales service for quicker, less expensive interventions.



*The machine is fitted with safety devices used to prevent dangerous situations for the operator. It is important that before starting any operation, the operator checks the perfect working order of these devices.*



*The non-functioning of a safety device, whether caused by a fault or tampering, can cause serious damage to the machine and consequently put the operator's life at risk. The Constructor has designed the machine and safety devices in order to guarantee the maximum to its customers, however the devices must be checked periodically according to that described in this manual and they must never be tampered with.*



*The service function on the remote control can be used as an aid for checking electric safety devices.*



*Never intervene on the safety devices. If they are tampered with, the manufacturer declines all liability regarding any accidents that may be due to such tampering.*

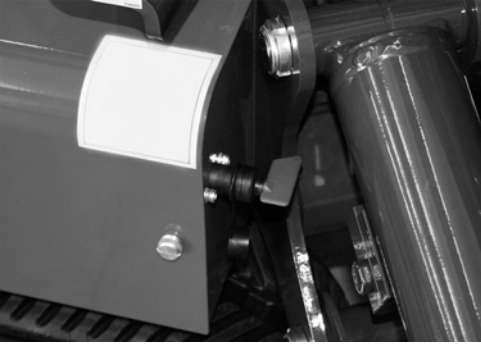


*It is prohibited to tamper with the lead sealing or setting of the maximum pressure valves and the adjustments of the electrical components. If they are tampered with the manufacturer declines all liability for any accidents that may be due to such tampering.*



*The Constructor is not liable for any damage/injury caused by the machine to objects and/or persons due to failure to comply with the above instructions.*

## 8.1. BATTERY CUT-OUT SWITCH



**Fig. 7** Battery cut out switch thermal Engine version



**Fig. 8** Battery cut out switch Lithium version

This device is used to isolate the machine's electrical circuit. It is well visible and easily accessed without using tools. It only needs to be activated for prolonged machine downtime or maintenance operations. Turning the key clockwise closes the machine's electrical circuit, while turning it anticlockwise isolates the machine's electrical circuit and the key can be removed.



*Before disconnecting the battery by means of this device, make sure that the engine key is in position "off" and the remote control and electronic board are off.*

## 8.2. DISTRIBUTOR PRESSURE RELIEF VALVES



**Fig. 9** Aerial part pressure relief valve



**Fig. 10** Ground part pressure relief valve 1



All platform distributors have a pressure relief valve that limits the pressure inside the system to the value set for the same valve. These valves are set when the platform is tested by qualified personnel and must not be tampered with for any reason whatsoever.

### 8.3. CYLINDER STOP VALVES



**Fig. 11** *Cylinder stop valves*



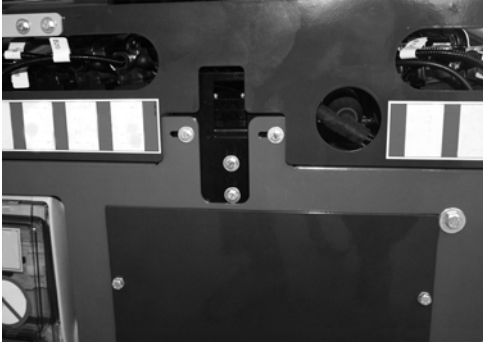
**Fig. 12** *Cylinder stop valves*

The stabiliser cylinders have a double stop valve which in case of system breakdown or hose breakage stops the cylinder preventing dangerous platform instability situations. All cylinders that move the aerial part of the platform structure are fitted with a stop valve which in case of system breakdown or hose breakage stops the cylinder preventing the basket from falling due to gravity.

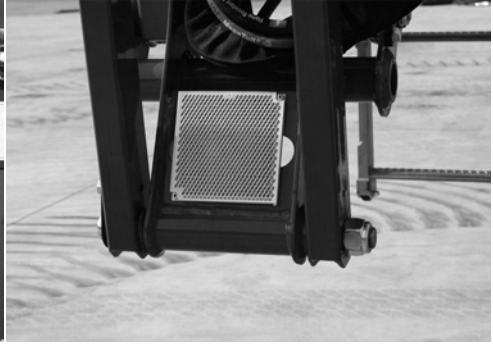


*These valves are calibrated in the platform inspection phase by the constructor and must not be tampered with for any reason.*

#### 8.4. ALIGNMENT PHOTOCELLS OF THE AERIAL PART



**Fig. 13** *Photocells*



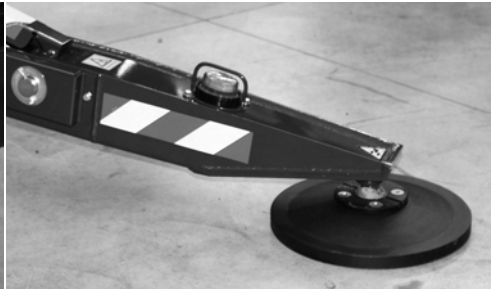
**Fig. 14** *Reflector*

The platform has two safety photocells that ensure that the aerial part of the machine is completely lowered and aligned with the base and that the telescopic arm is completely retracted. When these conditions are not met, a signal is sent that disables the movement of the stabilisers.

#### 8.5. STABILIZER POSITION MICRO SWITCHES



**Fig. 15** *Stabilizer micro switches*



**Fig. 16** *Indicator light plate on the ground*

The position of the stabilisers and their contact with the ground are detected by 4 micro switches positioned near the stabiliser cylinder rod fastening pin. The micro switches fixed to the stabiliser must be released when the stabiliser rests on the ground.



*Check the correct operation of the micro switches every day.*

## 8.6. JIB POSITION MICRO SWITCH



**Fig. 17** JIB micro switch

The position of the jib arm is detected by a micro switch that is secured to the jib arm itself. The micro switch must be released when the jib arm is closed.

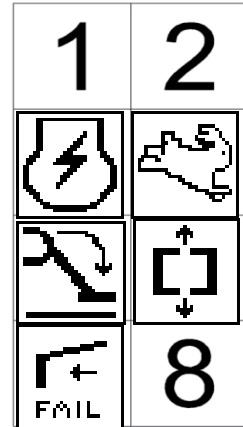


*Check the condition and correct operation of the JIB micro switch every day.*

## 8.7. ROPES INTEGRITY MICRO SWITCH

The integrity of the ropes system that moves the telescopic arm is verified by a micro switch that detects the position of the rope pull balancing system.

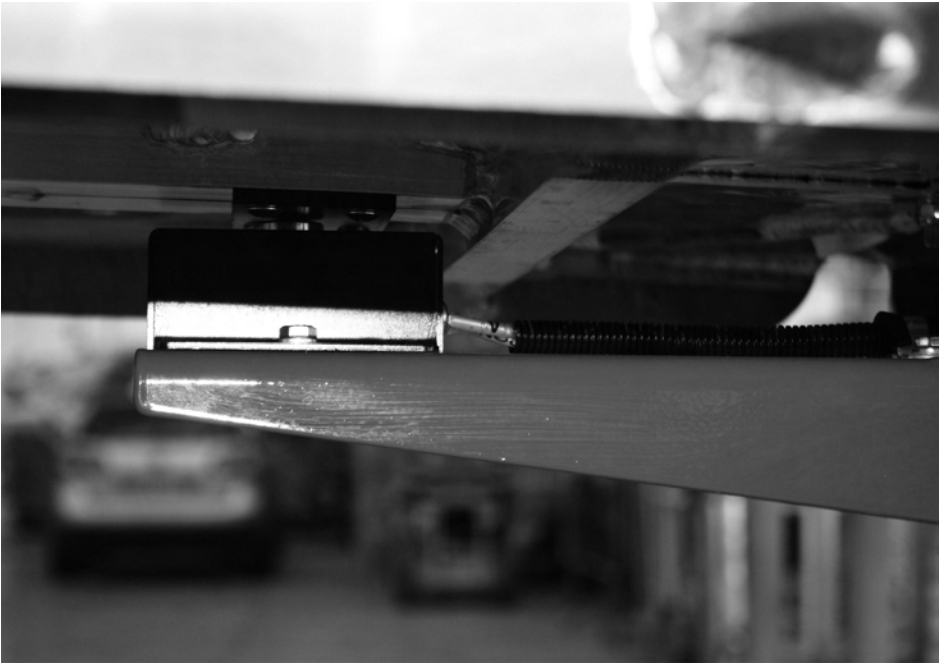
When both ropes are integral, the balancing system is parallel to the machine axle and the micro switch must be released. If the micro switch is not released due to an anomaly on one of the two ropes, a warning message appears on the remote control display.



**Fig. 18** Ropes micro switch    **Fig. 19** Micro switch position

**Fig. 20** Ropes error

## 8.8. BASKET LOAD SENSOR



**Fig. 21** *Basket load sensor*

The load sensor on the basket is made up of a basket support with two shafts that only allow the vertical movement of the basket. The basket support is supplied by the load cell itself. Two strain gauges are positioned inside the sensor positioned under the basket and convert the relative weight inside the basket into an electrical signal. The electrical signal is then sent to the electronic board, which processes it and identifies any dangerous conditions. The remote control display always shows the maximum load allowed according to the work mode. When the maximum allowable load is reached, an icon appears on the remote control display, a sound signal is emitted and all platform movements are disabled. To restore platform operation the excess weight must be removed in order to return below the maximum allowable weight.



*The Constructor recommends that maximum attention is paid to the conditions of all safety components and in particular of the system that makes up the basket load sensor; always check correct operation whenever objects are struck with the basket or if performing operations that may damage the system (e.g. pruning, painting etc.).*

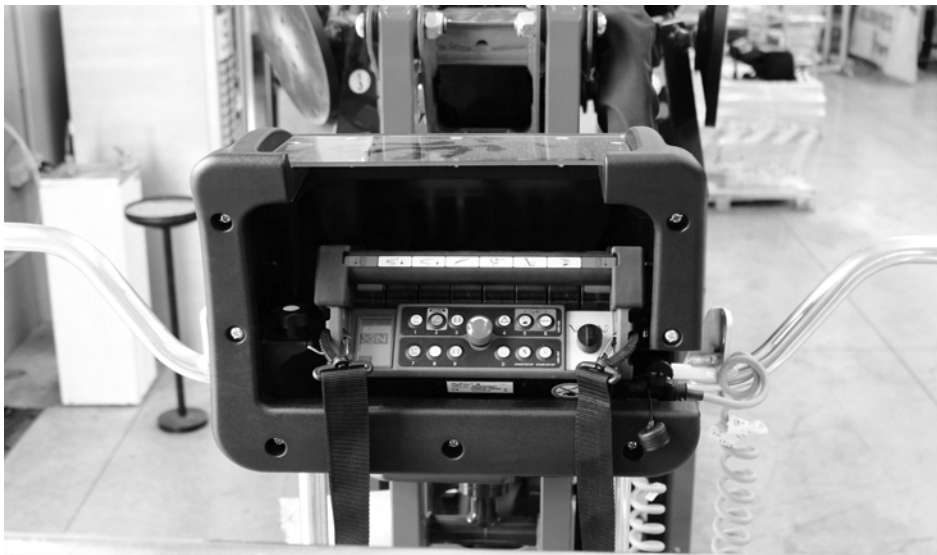


*Before any elevating manoeuvre, always make sure that the two closing covers on the vertical pins are completely screwed in.*



**Fig. 22** Lock pin cap

## 8.9. CONTROL PROTECTION



**Fig. 23** *Basket control protection*

A protection structure is provided to protect the remote control against the accidental fall of objects from above and involuntary activation by the operator.



*Always make sure that this protection structure is intact before using the machine.*

## 8.10.SPIRIT AND ELECTRONIC LEVEL

**Fig. 24** *Visible spirit level***Fig. 25** *Electronic level*

The spirit level is positioned on the turret and it is readily visible from the basket and from the ground. The spirit level must be used to make sure that during the platform levelling phase the maximum allowable gradient of  $1^\circ$  is complied with. This condition is met when the air bubble is inside the green area.

A second electronic level contained in the control board makes sure that this condition is effectively satisfied and checks the power supply to the controls for the aerial part.



*Always check the correct levelling of the machine after every self levelling operation.*



*Approximate levelling outside of the limits set by the manufacturer is very dangerous and can affect the stability of the platform, which represents a risk, even deadly, for the operator and other persons working on the machine and near it.*



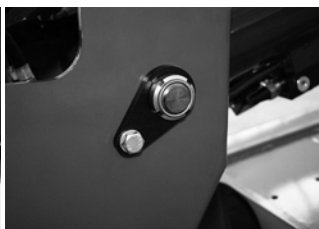
*Never intervene on the spirit level adjustments; this device is calibrated by the Constructor during the inspection before sale. Only technicians authorised by the Constructor and in possession of suitable tools can intervene on the spirit level.*



### 8.11.PIN LOCKING BOLTS AND NUTS



**Fig. 26** *Flange*



**Fig. 27** *Bolts to stop rotation*



**Fig. 28** *Selflocking nuts*

All the pins used on the platform were treated against wear and are fitted with flanges to prevent them from rotating inside their seat. Some pins have bolts to stop rotation while others pins have a joint in the structure of the machine. The pins in the most delicate positions are threaded at the ends and are fitted with self locking nuts or self locking threaded ring nuts to prevent the structure from subsiding. Check the correct tightness of all the pin locking devices according to the intervals indicated by the manufacturer of the machine.



*Never loosen the pin locking devices and periodically check they are correctly tightened. A pin that comes off its housing, even partially, may cause unexpected and uncontrollable movements and even cause the machine to lose stability and/or the basket to fall.*

## 8.12.SAFETY DEVICE ELECTRONIC CONTROL BOARD



**Fig. 29** *Electronic board position*

The platform has an electronic control board that enables the power supply to the ON-OFF proportional coils after verification of the safety conditions by the sensors positioned on the machine. The control procedure on the electronic board may be bypassed using the key selector switch with spring return: “safety device bypass key”. The electronic board records every bypass action carried out by the operator on the safety devices, filing them by date, time and lapse of time during which the operator held the “safety device bypass key” in position. The board is also provided with an event record that stores all the operations performed on the machine for a variable period of time.

## 8.13.BOOMS POSITION SENSORS

One or more cylinders of the aerial part arm are equipped with an internal position sensor that allows the circuit board to know the position of the cylinders and adjust the speed. The electric connection of the sensors is visible on the bottom of the cylinders. When one of the sensors is broken or its signal no longer reaches

the main circuit board an icon appears in position 7 of the remote control "Display (p. 55)". If one or both sensors should break, contact the after sales service.

#### 8.14.EXTERNAL TEMPERATURE SENSOR (OPTIONAL)

If the machine is approved for use in outdoor environments for the Russian market, the Compact Crawler Boom will be installed with a temperature sensor/cut out. Should the ambient temperature drop below a predetermined limit, refer to "Danger due to atmospheric conditions (p. 82)", the function being operated will stop and an audible alarm will sound. Operators must lower the platform to the ground, by first placing the function being operated into a neutral position and then selecting controls which will permit the platform to be lowered to the ground safely. Movement during this time will be at creep speed.



*Should a more urgent recovery of the platform be required, for example, in the event of a failure of the platform controls or the incapacitation of an operator, the ground control panel may be used by trained personnel at normal function speeds to lower the platform to the ground safely.*



*A visually check is required before operation of the machine to ensure the sensor is secure and free from dirt or debris.*

*Do not operate a machine displaying an error code or warning.*

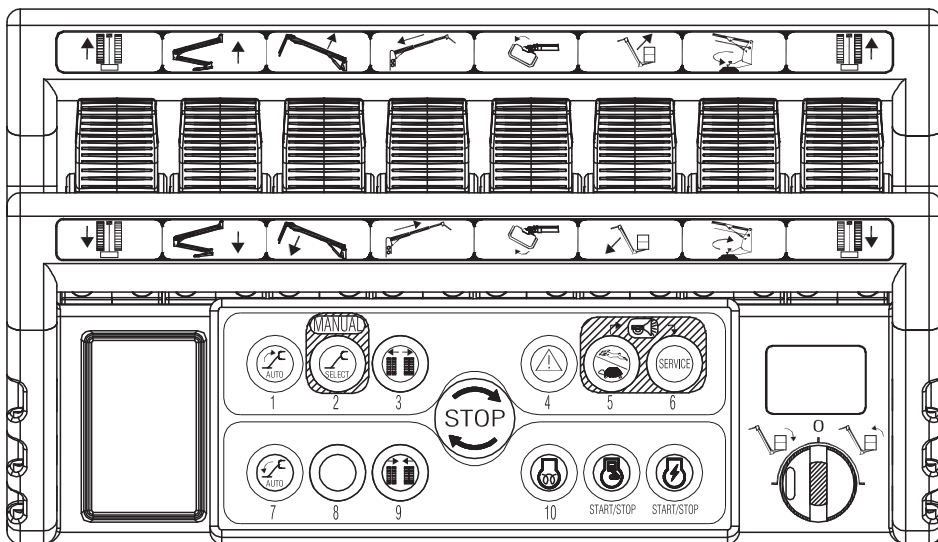
## 9. INSTRUMENTS AND CONTROLS

Below is a description of all the controls and indicators present on the machine; each device has a sticker that briefly describes its function applied nearby, often containing symbols that are used to ensure quick and clear understanding. Before using the machine, the following descriptions must be read in order to gain in-depth knowledge of the functions of each device and to be aware of any suggestions provided by the manufacturer.



*Before starting to use the machine, the operator must read and perfectly understand all the instructions contained in this manual.*

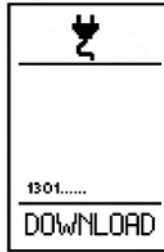
### 9.1. REMOTE CONTROL



The remote control contains most of the controls required for normal operation of the machine. It is made up of buttons, joysticks, a key selector switch and a display. The remote control continuously exchanges data with the machine's main board, which in turn transmits the information to be shown on the display.

**9.1.1. Display**

The display is used to view the status of the machine and the operating information necessary or useful for the operator. When the machine's main control board is powered via the engine key, the information to be shown on the display is sent to the remote control. This operation has a variable duration. Normally a few seconds are sufficient, however the following screen may appear on the display:



**Fig. 30** *Download icons remote control*

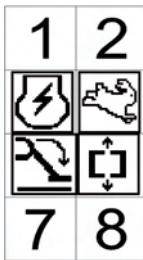
In this case about 10-15 minutes are needed to send all the information from the main board to the remote control. The machine cannot work during this period.



*Do not stop the machine or operate it during this period.*

**Display main screen**

When the machine is started, the main screen is displayed, giving a general overview of the machine status. For the sake of simplicity and clarity a layout is provided with 8 icon display positions.



**Fig. 31** *Main screen example*



**Fig. 32** *Location diagram icons*

**POSITION 3:**

Position 3 displays the selected engine and the engine status.



**Fig. 33** *Petrol/Diesel engine*



**Fig. 34** *Electric motor*

An X on the icon indicates that the engine/motor is off, no X indicates that it is on.

**POSITION 4:**

Position 4 displays the selected speed or the reduced speed for the Lithium:



**Fig. 35** *Slow*



**Fig. 36** *Normal*



**Fig. 37** *Fast*



**Fig. 38** *Reduced*

**POSITION 5:**

Position 5 displays the icon confirming that overhead movements are enabled.



**Fig. 39** *Stabilized machine*

This icon means that all conditions for using the overhead movements have been checked and the aerial part can be lifted. No icon on means that the aerial part cannot be lifted. In place of this icon, the basket overload icon may be shown.



**Fig. 40** *Overload*

When the load sensor measures a load exceeding the allowed work load the main screen disappears for three seconds, replaced by the overload error display, the audible warning is activated, then the overload icon appears in position 5 in place of the icon enabling the overhead movements.



**Fig. 41** *Overload error*

#### **POSITION 6:**

Position 6 displays the icon confirming that track movements (stabilisers, tracks, track extension) are enabled.



**Fig. 42** *Aerial part closed and aligned*

This icon means that all conditions for operating the track movements have been checked. No icon on means the stabilisers cannot be used and the track cannot be extended. The machine, however, can travel even when the icon is off, as long as all 4 stabilisers are lifted from the ground.

#### **POSITION 7:**

Position 7 is used for functional signals:



**Fig. 43** *Emergency stop pressed*

Signals that one of the emergency stop buttons on the machine has not been released.



**Fig. 44** *Low battery level*

Indicates that the battery charge level is below the minimum limit allowed. If this message appears, it is advisable to recharge the battery, either by keeping the diesel or petrol engine on, or by connecting to the network.



**Fig. 45** *Lithium error*

Signals an error in the battery management system of Lithium version.



**Fig. 46** *CAN BUS error communication*

The machine has a CANBUS line connection fault.



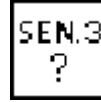
**Fig. 47** *Card fail*

A faulty or incorrect electronic board (card) has been installed, or alternatively an incorrect software version has been loaded.





**Fig. 48** Reading error sensor cylinder 1



**Fig. 49** Reading error sensor cylinder 3

The sensor inside the cylinder is not working properly.

**POSITION 8:**

Position 8 displays the battery charge status or the icon indicating the battery is being recharged in the Lithium version.



**Fig. 50** Lithium battery status



**Fig. 51** Lithium battery charging

Position 8 is used to show the selection of the emergency descent operation from the basket with solenoid valves on the cylinders.



**Fig. 52** Gravity emergency descend



*In addition to the main screen described above, there are other functional displays that will be described successively.*

**9.1.2. Joystick**

Using the joysticks the operator selects the movement to be performed, the direction and the speed. The direction of the joystick determines the direction of the movement. The degree of movement of the joystick determines the speed. The more the joystick is moved away from the central neutral position, the faster the movements obtained.

Starting from the left in the figure shown below, the joysticks are numbered from 1 to 9. The following table shows the movement controlled and its direction depending on the joystick shifting direction.

A=Forward

B=Backward

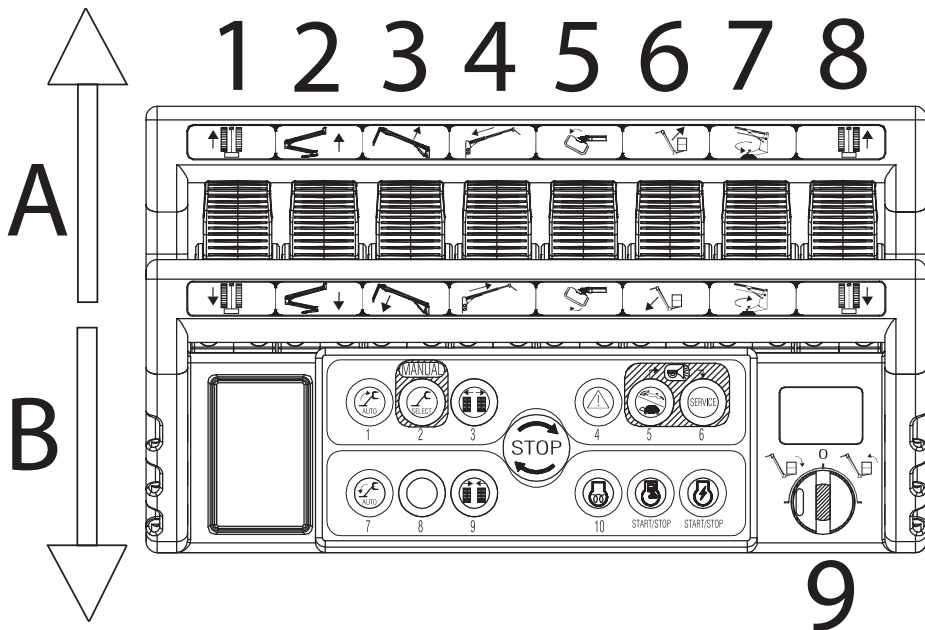


Fig. 53 Joystick controls

Joystick	Direzione movimento Joystick	Movimento comandato
1	FORWARDS	LEFT TRACK FORWARDS
	BACKWARDS	LEFT TRACK BACKWARDS
2	FORWARDS	1°-2° ARM UP
	BACKWARDS	1°-2° ARM DOWN
3	FORWARDS	3° ARM UP
	BACKWARDS	3° ARM DOWN
4	FORWARDS	EXTENSION ARM IN
	BACKWARDS	EXTENSION ARM OUT

Joystick	Direzione movimento Joystick	Movimento comandato
5	FORWARDS	ROTAZIONE CESTO ANTIORARIA
	BACKWARDS	ROTAZIONE CESTO ORARIA
6	FORWARDS	JIB OPENING
	BACKWARDS	JIB CLOSING
7	FORWARDS	ANTICLOCKWISE ROTATION
	BACKWARDS	CLOCKWISE ROTATION
8	FORWARDS	RIGHT TRACK FORWARDS
	BACKWARDS	RIGHT TRACK BACKWARDS
9	RIGHT	CLOSE BASKET LEVELLING
	LEFT	OPEN BASKET LEVELLING

### 9.1.3. Push buttons

The buttons have a dual function: they can be used to select machine functions or as numerical keys in the service sub menus. They in fact feature an icon that represents their meaning and a number for use as a numerical keypad. An emergency STOP button is also available which, when pressed, stops the motor and brings the machine to a standstill. The pressed position of the emergency STOP button is represented on the display in position 7 "Display (p. 55)". To make the machine operational again, the button must be turned and released.

For the description of the individual functions, refer to "Using the machine (p. 82)".

#### **BUTTON 1:**



Used to automatically raise the stabilisers.

#### **BUTTON 2:**



Enters the menu for the manual movements of the individual stabilisers.

### BUTTON 3:



Used to extend the tracked undercarriage.

### BUTTON 4:



Used to enable control of the emergency descent from the basket. Confirmation that the operation is enabled is displayed on the screen in position 8 "Display (p. 55)".

### BUTTON 5:



Used to select the travel speed and the engine/motor speed.

There are three speeds available:

- **SLOW**: engine at 1500 (1800) rpm for the operation of the aerial part, at 2200 rpm for the operation of the carriage. Minimum possible speed for the tracks.
- **NORMAL**: variable rpm according to the selected movement. Travel motors always with maximum displacement, therefore medium travel speed.
- **FAST**: variable rpm according to the selected movement. Travel motors in automatic displacement variation mode, therefore maximum travel speed.

The three speeds are selected by pressing button 5 in sequence, with a cyclical routine. The selected speed is displayed on the screen in position 4.

### BUTTON 6:



Enters the auto service menu "Service menu on the remote control (p. 192)".

**BUTTON 7:**



Used to automatically lower the stabilisers.

**BUTTON 9:**



Used to narrow the tracked undercarriage.

**BUTTON 0 (10):**



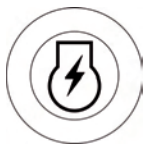
Allows the preheating of the engine.

**BUTTON 11:**



Allows the engine to be switched on/off. If the button is pressed with the engine on, this will be stopped.

**BUTTON 12:**



Allows the electric motor to be switched on/off. If the button is pressed with the engine on, this will be stopped.

If the start buttons are pressed with an emergency STOP button pressed, starting will be impossible. This condition is indicated by the icon STOP in position 7 "Display (p. 55)". If the operator attempts to start one of the two motors while the other is already running, starting will be impossible and the icon showing the motor already on will appear at the centre of the screen.

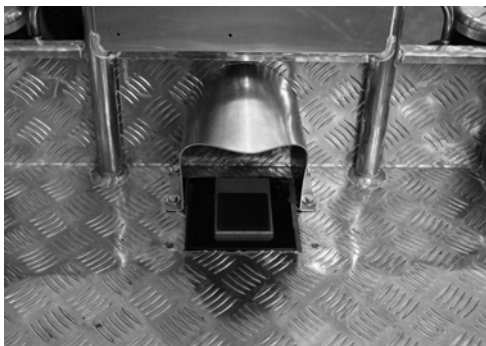


*Buttons 5 and 6 when pressed simultaneously also activate the horn (optional).*

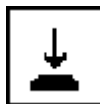


## 9.2. FOOT SWITCH (OPTIONAL)

Inside of the basket is fitted a foot switch device that must be pushed to allow the movement of the machine from the basket. If you try to move the machine without the foot switch pushed the movement will be prohibited and a message on the display will appear informing that it is necessary push the pedal to work. If you have not made moves to 7 seconds after pressing the pedal this must be release and pressed again to resume work.



**Fig. 54** Foot switch



**Fig. 55** Icon push foot switch

### 9.3. CONTROL POSITION

#### 9.3.1. Control position in the basket

The aerial work platform has been designed to be controlled by the operator in the basket using a remote control, where all of the machine functional controls are gathered, positioned in the relevant support inside the basket. A pedal (optional) is also present in the basket in order to allow the movement of the aerial part.

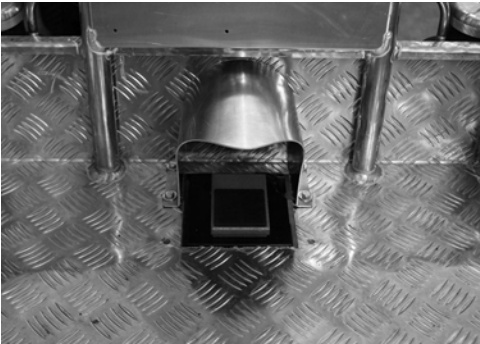
From this control position it is possible to control the extendible structure and machine stabilisation. When the machine is manoeuvred from the control position in the basket, the remote control must be positioned in the appropriate seat, and the foot switch must be activated (the foot switch must be release and activated again if no movements are made for more than 7 second). The remote control is connected to the machine using a flexible cable that allows

to shift it if the basket is to be removed or the ground control unit is to be used.

**Stabilisation of the machine must be preferably controlled from the basket drive position. Machine traversing must be carried out from the control position on the ground.**



*After accessing or leaving the control position in the basket, ALWAYS remember to close the ladder, to avoid any damage when operating the machine.*



**Fig. 56** Foot switch



**Fig. 57** Remote control

#### 9.3.2. Control position at the ground

There is a second control position available for the tracked part of the machine. This is not in a fixed position but rather can be located on the ground within a radius of 2.5 m from the basket attachment. To control the machine from this posi-

tion, the operator uses the same remote control, removing it from its housing in the basket and using the cable provided.



*From this control position, the operator IS NOT enabled to control the aerial part of the machine, but only the tracks, stabilisers and track extension function.*



*When controlling the machine from the ground position, keep a distance of at least 1 m from the tracks.*



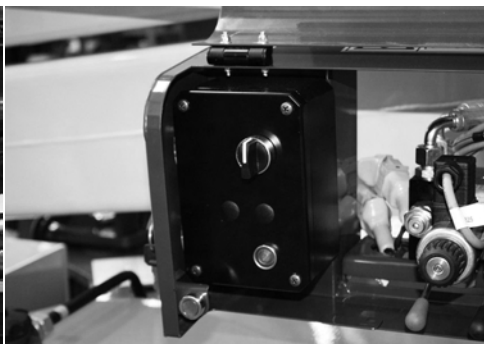
*When controlling the machine from the ground position, always make sure that the component that is being moved is completely visible and constantly check its trajectory.*

### 9.3.3. Emergency control position

There is a control position which will be identified as the emergency control position. This is located on the ground part of the machine, next to the distributor for the aerial part. To enable it, press the special selector positioned on the base of the turret until the green warning light comes on. The light indicates that the movements of the aerial part are enabled.



**Fig. 58** Selector Petrol/Diesel version



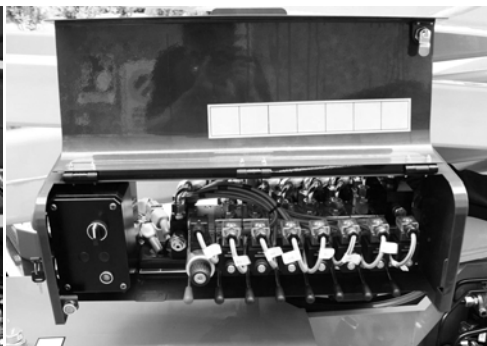
**Fig. 59** Selector Lithium version

From this position, the movements of the machine can be controlled directly using the levers on the various hydraulic distributors, aerial part and proportional.





**Fig. 60** *Carter hydraulic control ground part*



**Fig. 61** *Carter hydraulic control aerial part*



**DANGER**

The emergency control position was designed to operate on the extensible structure only for emergency operations by emergency service personnel on the ground, who must in any case be trained and know the operation of the machine and its safety devices, as well as for maintenance and checks before starting work.

**If an operator is in the basket, it is forbidden to move the structure from the ground position, unless in an emergency situation (sudden operator illness, technical fault).**

#### **9.3.4. Maintenance control position**

There is a control position usable only for operations of ordinary and extraordinary maintenance operations, position placed next the machine near the electric components box.

At the back of the protection box of the circuit board an auxiliary connector is placed for the connection of the optional second remote control.



**Fig. 62** *Position connector optional second remote*

To enable this position it is necessary to operate on the key selector placed on the base of the turret and connect the optional second remote control to the machine.

**Before proceeding with the connection read carefully paragraph regarding the use of the optional second remote control "Maintenance control position with remote control from the ground (p. 144)".**



*This control position is usable only to carry out controls and maintenance on the machine. Do not use this position to control the machine during normal working operations.*



*It is absolutely forbidden to move the machine from this position if one or more operators are in the basket.*

**9.4. REMOTE CONTROL MOVE (OPTIONAL)**

In order to enable the ground movements of the machine is compulsory push the 8 button. If the 8 button is not pressed before move the ground part a message appear on the remote control display. Once pressed the 8 key if are not move commands within 7 seconds consents will be disabled and will be need to press the button 8 again to reactivate them.



*This option is enabled as standard for the Australian market machine.*

**9.5. SKYGUARD™ SYSTEM (OPTIONAL)**

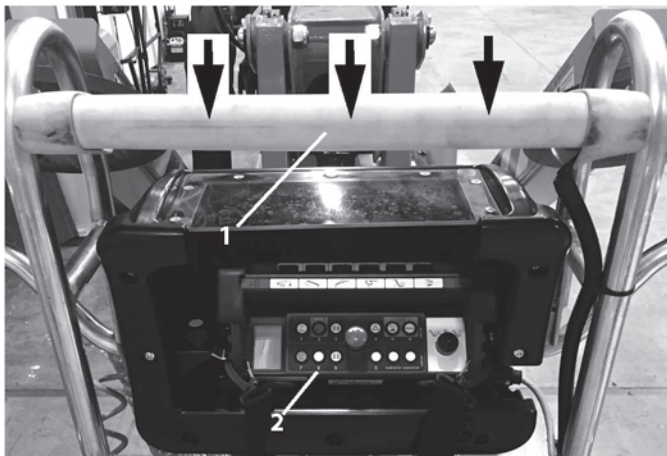
The SkyGuard™ feature is used to provide enhanced control panel protection. When the SkyGuard™ sensor is activated, functions that were in use at the time of actuation will reverse or cut-out and the ground alarm will beep. The table below outlines these functions.



*Reverse motion can be stopped by the operator by releasing the footswitch, depressing the emergency stop button, or by releasing pressure on the SkyGuard™ sensor.*

If SkyGuard™ remains activated after function reversal or cutout, depress and hold the SkyGuard™ Override Switch (button number 8) to allow normal use of machine functions until the SkyGuard™ sensor is disengaged.

1 boom up	3 boom up	JIB up	Extension out	Rotation AE	Rotation Basket	Basket leveling	Drive Forward	Drive Reverse
R	R	C	R	R	C	C	C	C
R= Indicates Reversal is Activated								
C= Indicates Cutout is Activated								



**Fig. 63** 1- SkyGuard™ Sensor 2- SkyGuard™ Override Switch (button number 8)

### SkyGuard™ Function Test

From the basket control position, test the SkyGuard™ feature by setting up machine and operating the telescope out functions and then activating the SkyGuard™ sensor. The telescope out function will stop and the telescope in function will operate for a short duration and the beeper will sound until the SkyGuard™ sensor are disengaged.

Disengage the SkyGuard™ sensor, release control, press and release the emergency stop on the remote control in the basket, make sure normal operation is available.

If SkyGuard™ remains activated after function reversal or cutout, depress and hold the SkyGuard™ Override n° 8 remote control button to allow normal use of machine functions until the SkyGuard™ sensor is disengaged.

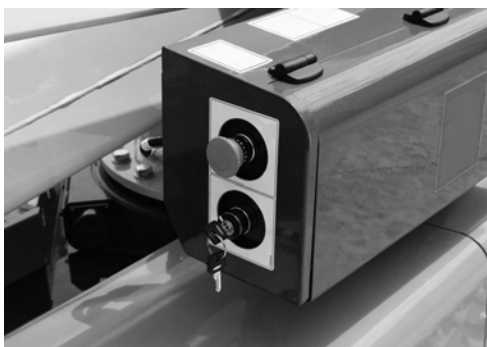
## 10.EMERGENCY DEVICE

The following information concerning the emergency devices is provided to help understand the behaviour of the machine and the possible work sequences; moreover, the devices can thus be identified more clearly and quicker action can be taken if emergencies occur.



*It is important that before starting any operation the operator checks the perfect working order of the emergency devices.*

### 10.1.EMERGENCY STOP BUTTON



**Fig. 64** *Emergency stop button ground part*



**Fig. 65** *Emergency stop button on remote control*

Allows immediate shut-down of all machine functions in emergency conditions. The machine is provided with two emergency stop devices: the first is located on the carriage just above the turntable, the second on the remote control. Once the device has been activated, the button must be turned and released to allow the machine to operate again. Selection of the emergency stop is indicated on the remote control display "Display (p. 55)".

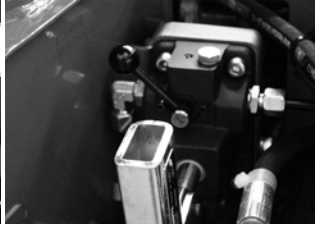


*It is strongly recommended to comply with the rule whereby the platform must not be operated without personnel available on the ground. Indeed, accidental operation (e.g. due to a falling branch) or voluntary operation of the emergency button by unauthorised persons on the ground would put the occupants of the basket in the unpleasant situation of not being able to perform any movements, except descent using the emergency descent devices.*

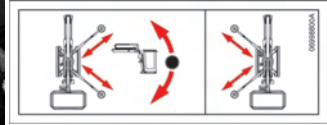
## 10.2.HAND PUMP



**Fig. 66** *Hand pump*



**Fig. 67** *Hand pump hydraulic diverter*



**Fig. 68** *Hand pump decal instructions*

The hand pump is used to pressurise oil for emergency movements made necessary by any breakdown of the main hydraulic system. The hand pump has a manual switch used to select whether part of machine to control depending on the selection made according to the logic described in the legend above.



The hand pump is provided with a removable handle which is fixed on the carriage of the machine.

### 10.3.SOLENOID VALVES FOR EMERGENCY DESCENT



**Fig. 69** *Solenoid valves for emergency descent*

The cylinders of the first-second booms, of the third boom and the JIB have a solenoid valve for emergency descent. Activating the emergency descent button on the remote control "Push buttons (p. 61)" energises these solenoid valves, which allow the descent of the aerial part of the structure due to gravity. The use of this emergency device depends on the platform's electrical system being powered.

### 10.4.SAFETY DEVICE BYPASS KEY

The machine has a key device that acts on the electrical circuit, bypassing the platform safety systems. The device is situated on the cover of the electrical components compartment. The use of this selector switch is illustrated in the following paragraphs on how to use the machine.




*Considering the hazard deriving from the use of the platform during the bypass of the safety devices, carefully read the paragraphs regarding the use of the safety device release key selector switch.*

The key used to activate the safety device bypass is lead sealed on the side of the electrical components compartment near the battery. Force the lead sealing to remove it. After using the safety device bypass an after sales centre must be contacted in order to verify the causes that determined the need to use the safety device bypass and to lead seal the key.

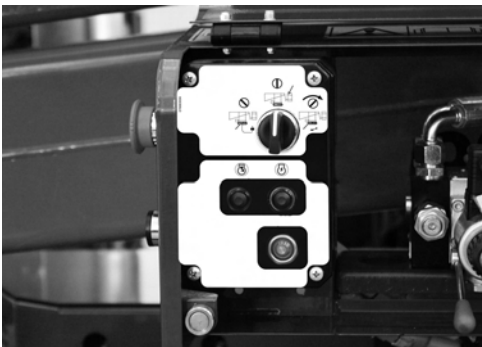


*The safety device bypass system is used to move the machine with a higher load than the limit load allowed inside the basket; the overload alarm is nonetheless displayed and the beeper warns the operator of the dangerous conditions. This device must only be used by expert personnel trained on how to use the machine, while the end user, who does not fully know the machine's operating principles, is not allowed to use this device.*

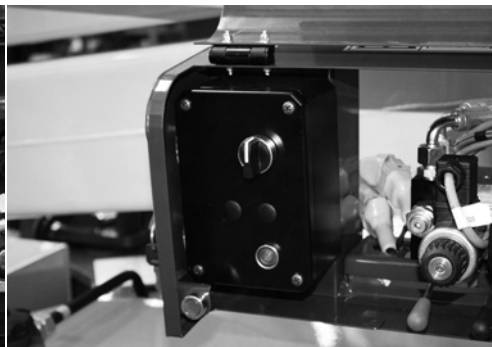
 *The safety device electronic control board records when the safety device bypass key is used and the movements carried out during these operations.*

## 10.5. EMERGENCY POSITION CONTROLS

### 10.5.1. Selection panel, emergency stop and starting

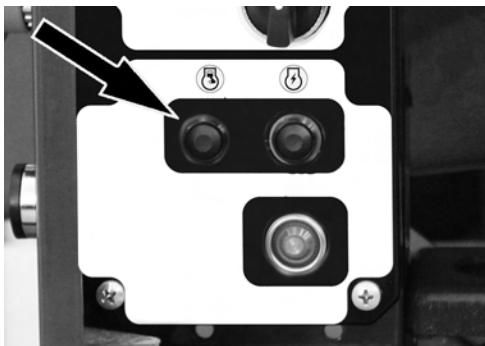


**Fig. 70** Selector Petrol/Diesel version

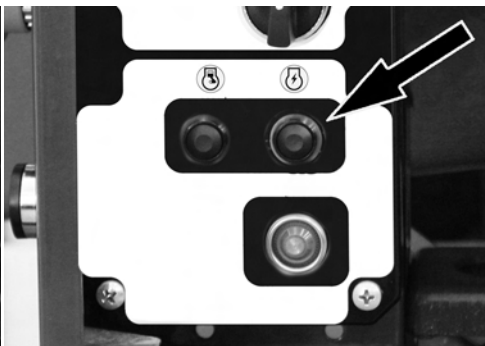


**Fig. 71** Selector Lithium version

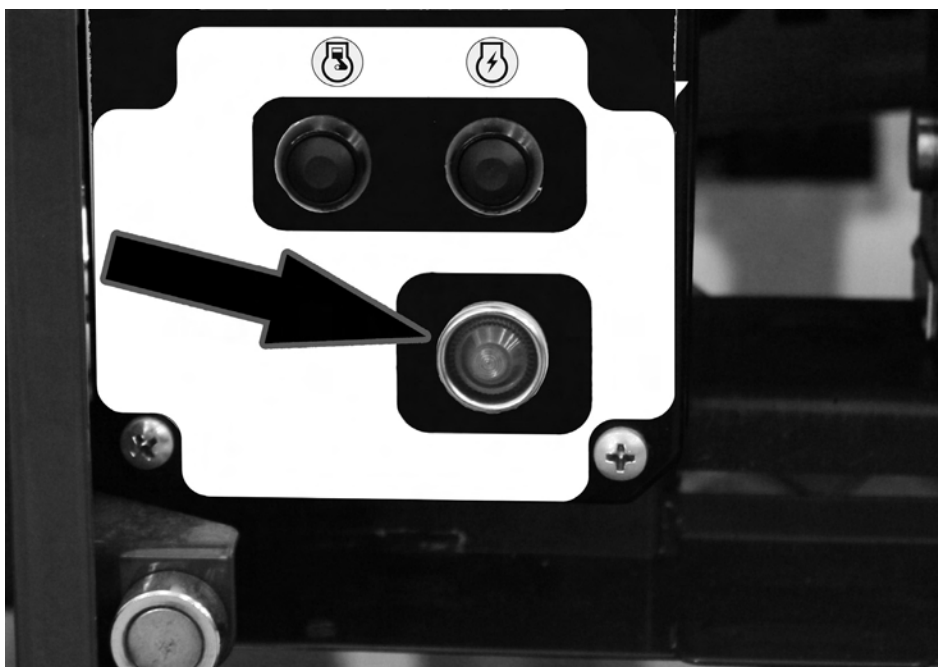




**Fig. 72** Engine start button



**Fig. 73** Electric motor start button



**Fig. 74** Aerial part movements enabled light

This panel houses the following controls:

- Three position control for selecting the control position.

- The central (neutral) position of the selector enables the use of the primary remote control in the basket.
- Turning clockwise and holding it in position enables the emergency control position and energises the main proportional valve on the hydraulic system for moving the arms. On the Lithium version, it also starts the electric motor. The main proportional valve can only be enabled if all the conditions that allow the movement of the aerial part have been satisfied. This is signalled by the icon on the remote control in position 5 "Display (p. 55)", and repeated on this panel by the green light coming on.
- Turning anticlockwise enables the control position for maintenance using the remote control on the ground; this option can only be used for maintenance operations and for it to be enabled the primary remote control must be in the basket or the remote control cable in the basket must be connected to the special adapter. To connection of the remote control to the ground, and its use see "Maintenance control position with remote control from the ground (p. 144)".
- Emergency STOP. If pressed stops the motor and stops the machine. To make the machine operational again, the button must be turned and released.
- START BUTTONS: Enable the selected engine/motor to be started, provided that all the emergency stop buttons have been released and all the conditions necessary for the start of the engine/motor are satisfied.

### ***10.5.2. Aerial part hydraulic distributor***

The hydraulic distributor is fitted with levers and buttons for the selection of the required movement, its direction and speed. The structure is moved by using the levers after holding the key in position.

The meanings of the levers on the distributor are described below:



Fig. 75 Controls distributor of aerial part

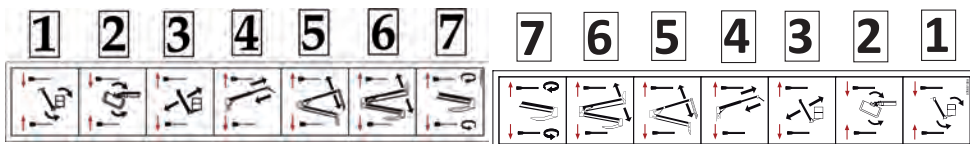
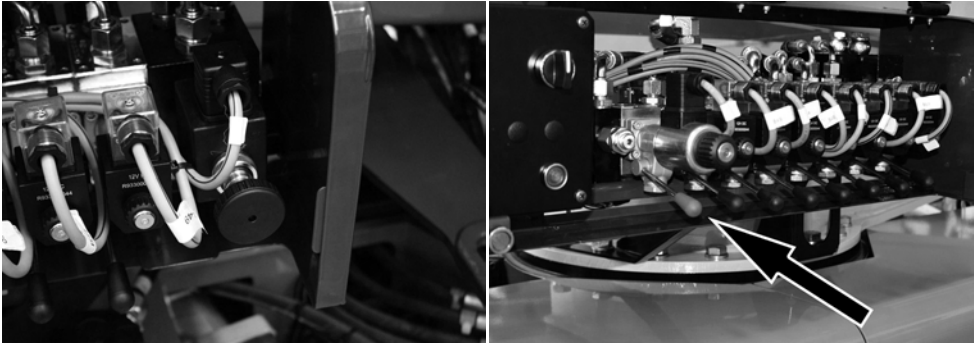


Fig. 76 Decals near the control

Ref.	Description	Drive / Motion
1	Basket levelling control	
		Moving lever upwards: basket closes

Ref.	Description	Drive / Motion
2	Basket rotation control	Moving lever downwards: basket rotates clockwise
		Moving lever upwards: basket rotates anticlockwise
3	JIB control	Moving lever upwards: il JIB opens
		Moving lever downwards: il JIB closes
4	Extension arm control	Moving lever upwards: extension arm out
		Moving lever downwards: extension arm in
5	Third arm control	Moving lever upwards: 3° arm up
		Moving lever downwards: 3° arm down
6	First-Second arm control	Moving lever upwards: 1-2° arm up
		Moving lever downwards: 1-2° arm down
7	Rotation control	Moving lever upwards: clockwise rotation
		Moving lever downwards: anticlockwise rotation



**Fig. 77** *Knob activation proportional valve aerial part*

At the distributor there is also the main proportional valve aerial part. The valve is equipped with a manual control for the drive in case of failure.



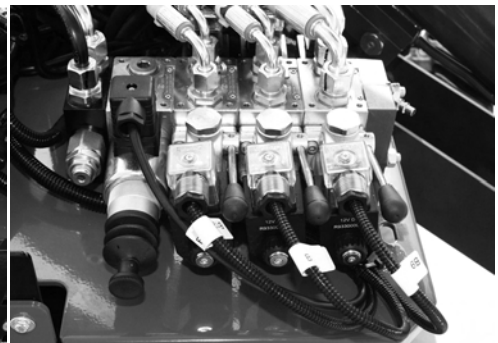
*Never operate the manual control of the proportional valve during normal operation of the machine.*

### 10.5.3. Tracked undercarriage hydraulic distributor

The meanings of the levers on the distributor are described below:



**Fig. 78** *Controls left distributor*



**Fig. 79** *Controls right distributor*



Fig. 80 Decals near the control ground 1

Fig. 81 Decals near the control ground 2

Ref.	Description	Drive / Motion
1	Rear left stabiliser control	Moving lever downwards: stabilizer down
		Moving lever upwards: stabilizer up
2	Front left stabiliser control	Moving lever downwards: stabilizer down
		Moving lever upwards: stabilizer up
3	Left track control	Moving lever upwards: moves left track forward
		Moving lever downwards: moves left track backward
4	Track extension	Moving lever upwards: extends track
		Moving lever downwards: narrows track
5	Right track control	Moving lever upwards: moves right track forward
		Moving lever downwards: moves right track backward
6	Front right stabiliser control	Moving lever downwards: stabilizer down
		Moving lever upwards: stabilizer up

Ref.	Description	Drive / Motion
7	Rear right stabiliser control	Moving lever downwards: stabilizer down
		Moving lever upwards: stabilizer up

At the hydraulic distributors there are also the main proportional valves ground part. The valves is equipped with a manual control for the drive in case of failure



*Never operate the manual control of the proportional valve during normal operation of the machine.*

## 11.USING THE MACHINE

### 11.1.SAFETY STANDARDS TO ADOPT BEFORE USING THE PLATFORM

#### 11.1.1.Risk of electrocution

If the machine must be used near electric power lines, the user must remain at a suitable distance from the latter. The table below supplies the values relating to the minimum distance from electric power lines depending on the type of voltage.

SAFETY DISTANCE FROM POWER LINES		
LINE RATED VOLTAGE		SAFETY DISTANCE (METRES)
FROM	TO	
0 V	300 V	5
300 V	50 KV	5
50 KV	200 KV	5
200 KV	350 KV	6.1
350 KV	500 KV	7.6
500 KV	750 KV	10.7
750 KV	1000 KV	13.7



*Keep a safe distance from mains power lines and electrical systems, considering the possible range of movement of the machine and its oscillation, as well as the possible oscillation of the power lines.*



*Before starting operation, examine the work area, taking note of overhead power lines, moving machinery, such as overhead cranes and road, rail and building equipment.*

#### 11.1.2.Danger due to atmospheric conditions

##### DO NOT WORK IN UNFAVOURABLE ATMOSPHERIC CONDITIONS

Do not work in the presence of storms, snow, fog or wind exceeding 12 m/s. Do not operate the machine when the ambient temperature drops below -20°C or



exceeds +40°C. Do not recharge the machine when the temperature is below 0°C or above 40°C.



*Should it unexpectedly rain, before resuming work always remember to check correct stabilisation of the platform and make sure that the ground is solid. Make sure that water has not penetrated into the electrical contacts.*

### Beaufort Scale (For Reference Only)

Beaufort Number	Wind Speed		Description	Land Conditions
	mph	m/s		
0	0	0-0.2	Calm	Smoke rises vertically
1	1-3	0.3-1.5	Light air	Wind motion visible in smoke
2	4-7	1.6-3.3	Light breeze	Wind felt on exposed skin. Leaves rustle
3	8-12	3.4-5.4	Gentle breeze	Leaves and smaller twigs in constant motion
4	13-18	5.5-7.9	Moderate breeze	Dust and loose paper raised. Small branches begin to move.
5	19-24	8.0-10.7	Fresh breeze	Smaller trees sway.

6	25-31	10.8-13.8	Strong breeze	Large branches in motion. Flags waving near horizontal. Umbrella use becomes difficult.
7	32-38	13.9-17.1	Near Gale/ Moderate Gale	Whole trees in motion. Effort needed to walk against the wind.
8	39-46	17.2-20.7	Fresh Gale	Twigs broken from trees. Cars veer on road.
9	47-54	20.8-24.4	Strong Gale	Light structure damage.

**11.1.3. Danger due to the work area**

THE MACHINE CAN ONLY WORK ON COMPACT AND LEVEL GROUND.

Always verify that the slope of the ground in the platform positioning area does not exceed the stabilization max inclination. During the stabilisation phase, use the spirit level positioned in proximity to the main controls to check that the maximum inclination of the coupling with respect to horizontal does not exceed 1°. Check the route for the presence of persons, holes, overhangs, obstacles, debris and coverings which may hide holes.



*Before entering any high risk areas (refineries, power stations etc.) check accessibility with plant safety staff.*

**11.2. PROCEDURES FOR CORRECT USE**

Below find the procedures for use of the platform as declared by the Constructor. Any use different to that stated below, unless authorised in writing by the Constructor. is prohibited.

### *11.2.1. Summary table of operator safety standards*

The summary table shown below lists the general safety standards that must be followed scrupulously by the operator before using the platform. Remember that a sticker with this table can be found near the controls positioned on the basket, where it is well visible from the control position.

- The elevating platform can only be used by specialised, previously trained personnel.
- All operations of the extensible structures must be performed from the control position in the basket. The travel and stabilisation operations must be carried out after checking that there is complete visibility of the work area. Before starting operation, examine the work area, taking note of overhead power lines, moving machinery, such as overhead cranes and road, rail and building equipment.
- The instructions contained in the USER AND OPERATION MANUAL that is provided together with the machine must be followed scrupulously.
- Do not exceed the maximum allowed capacity indicated in the USER AND OPERATION MANUAL and on the basket.
- The operator must wear a hard hat and a safety harness appropriately attached to the relevant anchorage points on the basket. Remember that the safety harnesses must be checked periodically. The use of harnesses is compulsory in accordance with local legislation in each individual country. In countries where the law does not require the use of such safety systems, the employer and/or user is responsible for choosing the system to be used.
- Before starting work, the operator must make sure that all the safety devices are in good working order, and check the efficiency of the main mechanical parts as well as the fuel and hydraulic oil level.
- Never operate on soft, rough, slimy ground or on slopes that exceed the allowable gradient, in order to ensure that the platform is completely stable. Make sure that the stabilisers rest on stable HORIZONTAL surfaces.
- Level the machine's chassis perfectly respecting the maximum allowable gradient indicated in the USER AND OPERATION MANUAL and visible on the spirit level.
- Before performing any movement, check that there are no obstacles in the work area and that no people are in the trajectory.
- It is prohibited to carry out work at a distance of less than 5 metres from power lines and electrical equipment.
- It is prohibited to operate in unfavourable atmospheric conditions.
- It is prohibited to anchor cables, ropes or the like to the platform and to use the platform as a lifting device.

- It is prohibited to secure ladders, stools or the like to the platform basket to increase the working height.
- Always operate the controls slowly and smoothly, without reversing movements suddenly.
- Remember that the basket must only be loaded and unloaded FROM THE GROUND.
- Do not use the machine or recharge the batteries at temperatures below or above the functional limits, ref "Danger due to atmospheric conditions (p. 82)".

11.3.WORKING AREA

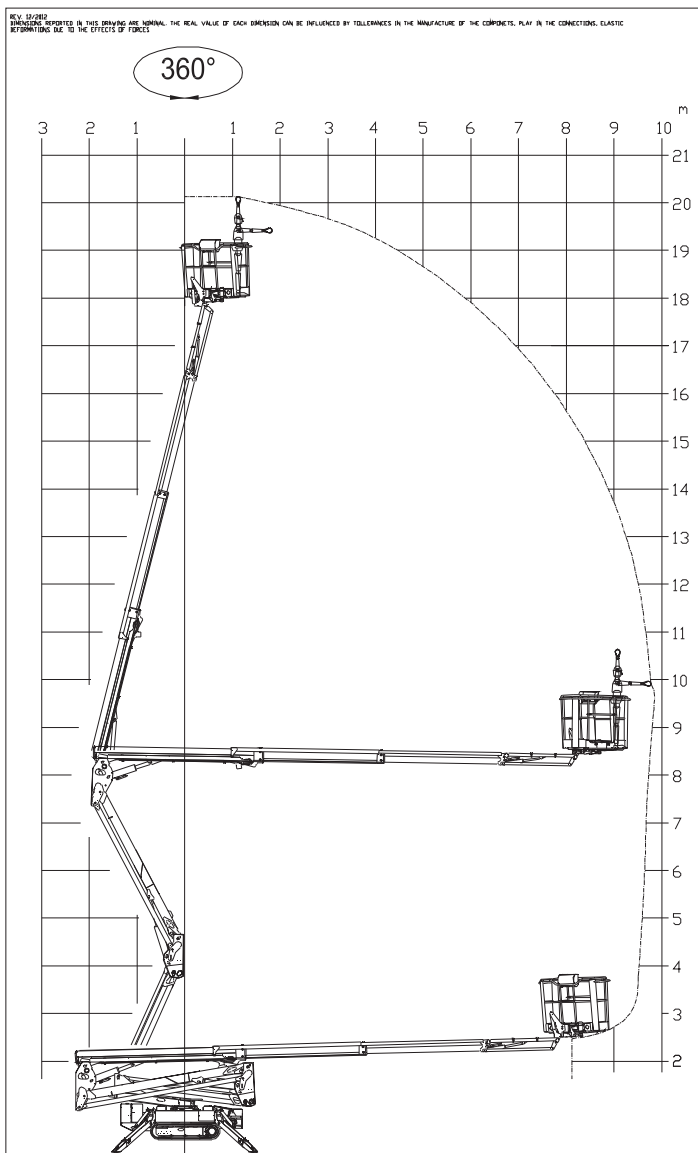


Fig. 82 Working area

#### 11.4. USE OF THE ELEVATING WORK PLATFORM (MEWP)



*In the explanations contained in the following paragraphs, it is assumed that the operator has already read and understood the contents of the previous sections of this manual. Therefore, warnings and photos which are already provided in other sections of this document will be repeated only when absolutely necessary.*



*The elevating work platforms are suitable for overhead jobs that are performed by an operator from inside the basket. The platform must be used exclusively by skilled personnel who are aware of the position and functions of all controls, instruments, indicators, warning lights and the meaning of the stickers and indications on the machine. The operator must have understood the platform operating procedures before using it. Correct use of the platform requires, as well as the presence of the operator (or operators) in the basket, also the presence of an expert operator on the ground who has to supervise work and be ready to intervene in case of dangerous situations and for any emergency operations. This implies that the personnel on the ground must be suitably trained regarding the functions of the controls and the procedures for use and that they have read the manual.*

- Failure to comply with even one safety provision may cause injury/damage to the operators and/or the machine.
- Keep a first aid box and a fire extinguisher near the work area. These must be used in compliance with the regulations in force.
- Do not remain within the platform operating range. The area below must be cordoned off; it is prohibited to throw objects from or towards the basket.
- Wear tight clothing and use all the PPE considered necessary based on the risk analysis of each individual site (shoes, hard hats, gloves and safety belts).
- When the work needs to be performed by two or more persons, before starting always agree on the correct procedure to follow. Always inform your fellow workers before starting the procedure.
- **At low temperatures start the motor and let it run for a few minutes, so that the hydraulic oil circulates and reaches at least 20°C before operating the platform.**
- When climbing into the basket, fasten the safety harnesses immediately to the appropriate fixing points before carrying out any operations. Remember that the safety harnesses must be checked and TESTED PERIODICALLY

- If the pressure of the stabilisers on the ground exceeds the allowable pressure on the ground, the support surface must be increased by inserting appropriate plates or a substrate of stable material (e.g. wood) between the ground and the stabiliser plate. This material must ensure good friction with the underlying ground and with the stabiliser plate. Any risk of the machine sliding on the ground must be eliminated.

#### ***11.4.1. Preliminary checks before starting work***

Carry out the following checks every day before using the machine:

- Check that there are no leaks from the hydraulic system. If leaks are present, carry out the necessary repairs and top up "Maintenance (p. 139)". Clean the area using a solvent or a pressurised solution of water and detergent, taking care to prevent contact with the electrical parts.
- Make sure there is no corrosion and there are no cracks around welded points.
- Check the condition and correct tensioning of the track belts "Maintenance (p. 139)".
- Check that there are no broken, damaged or missing components. Check the correct tightness of the pin locking bolts and nuts or the safety locknut. Before using the machine replace, tighten and adjust them according to the instructions of the platform manufacturer
- Eliminate debris that may cause fire or breakage, paying particular attention to the machine control area and the area around the diesel/petrol engine.
- Clean the handrails, foot boards and control levers removing any oil residues and debris that may affect safety during the operations, thus putting the operator at risk. Check the condition of the indicators and electric controls on the control board positioned on the basket.
- Check the condition of the adhesive labels positioned on the machine to ensure they are easily visible.
- Check that the quantity of fuel in the fuel tank is sufficient, in order to avoid useless down time and emergency descents.
- Check the correct operation of all safety devices.

#### ***11.4.2. Starting the Petrol/Diesel engine***

Before starting the engine it is necessary to:

- Become familiar with all the procedures described in the USER AND OPERATION MANUAL of the machine and of the engine, and to know the meaning of the safety labels;

- Examine the safety rule summary table in the manual and follow all the instructions given therein;
- Make sure that the fuel cap is properly tightened;
- Make sure that there are no residues of petrol or flammable materials near the exhaust silencer or other areas subject to overheating;
- Make sure that no one is standing near the machine;
- Make sure that all the emergency STOP buttons are released; this condition can be checked on the remote control display, where no icon should appear in position 7 "Display (p. 55)". If the operator attempts to start the machine with the emergency stop button still pressed, an error message will appear on the display when the start button is pressed.



**Fig. 83** *Error, ignition attempt with stop pressed*

- Once positioned the main key to the ON position to wait for the complete ignition of the electronic systems of the machine and the activation of the remote control. At this point, press the button on the remote control to start the engine.
- The petrol engine starter is automatic.
- If the operator attempts to start one of the two motors while the other is already running, starting will be impossible and the icon showing the motor already on will appear at the centre of the screen.

The machines with petrol engines are equipped with an automatic preheating system. Pushing button 0 (10) on remote control the running system is automatically set at 2200 rpm for 20 seconds in order to preheat the engine and improve the starting phases of use. If with this function active a movement that needs a different rotation system is attempted, the machine will automatically exit from the preheating mode and will perform the movement at the necessary speed. See paragraph concerning the functions of the remote control "Push buttons (p. 61)" before using this option.



The machines with Diesel engines are equipped with an automatic preheating system. Pushing button 0 (10) on remote control will be activated a preheat of 10 seconds. If the engine will be started during this time the preheat is stopped. See paragraph concerning the functions of the remote control "Push buttons (p. 61)" before using this option.



*The engine must be started with all the control buttons and joysticks in neutral position. Always make sure there are no foreign objects (e.g. Branches) that may accidentally operate a control, as the platform may move suddenly out of the operator's control and cause serious harm to things and/or people. Make sure that all the manual controls for the proportional valves are at rest.*

#### 11.4.3. Starting the electric motor

- Before starting the motor, be clearly aware of all the procedures described in the USER AND OPERATION MANUAL and get familiar with the meaning of the safety stickers.
- Examine the safety rule summary table in the manual and follow all the instructions given therein.
- Power the machine with an electric cable through the connection positioned at the bottom near the electric motor. Close the switch located in the electrical panel near the motor.

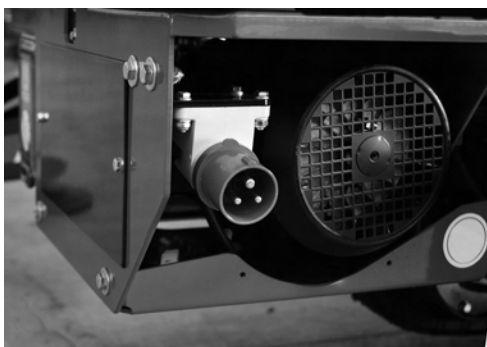


Fig. 84 Power line connection



Fig. 85 Main electric switch



*Before connecting the machine to the main power supply:*

- a Make sure that the specifications of the power line correspond to the voltage and frequency indicated on the electric motor rating plate.
- b Check the condition of the power cable; it must be sized for a rated power of 2.2 kW. Note that:
- c In the case of the electric motor 230V to the network are required at least 3.9Kw. Use to connect a cable pole least "3x2.5mm<sup>2</sup>" with ground socket type F47, double insulated with plug for at least 16A. The maximum cable length must be 10 m
- d In the case of the electric motor 110V to the network are required at least 4.1Kw. Use to connect a cable pole least "3x6mm<sup>2</sup>" with ground socket type F47, double insulated with plug for at least 32A. The maximum cable length must be 10 m
- e Place an earth plate in the ground and connect it to the machine's ground clamp or, if this is not possible, make sure the power connection is earthed (e.g. indoors).
  - Make sure that all the emergency STOP buttons are released; this condition can be checked on the remote control display, where no icon should appear in position 7 "Fig. 43 Emergency stop pressed(p. 58)". If the operator attempts to start the machine with the emergency stop button still pressed, an error message will appear on the display when the start button is pressed.



**Fig. 86** *Error, ignition attempt with stop pressed*

- Use the button on the remote control to start the motor.
- If the operator attempts to start one of the two motors while the other is already running, starting will be impossible and the icon showing the motor already on will appear at the centre of the screen.



*The engine must be started with all the control buttons and joysticks in neutral position. Always make sure there are no foreign objects (e.g. Branches) that may accidentally operate a control, as the platform may move suddenly out of the operator's control and cause serious harm to things and/or people. Make sure that all the manual controls for the proportional valves are at rest.*

#### **11.4.4. Stopping the engine/motor**

To stop the engine, press again button 11 on the remote control; it allows the engine to be switched off or on depending on its status.

To stop the electric motor, press button 12; it allows the electric motor to be switched off or on depending on its status "Push buttons (p. 61)".

#### **11.4.5. Stopping the motor Lithium version**

To switch off the electric motor, release the button or the lever on the remote control or release the emergency control key. The motor will stop automatically in 3-4 seconds.



*The electric motor can only be considered stopped if one of the emergency stop buttons on the machine is pressed.*

*Whenever a movement of the machine has been completed and work needs to continue with the machine off, one of the emergency stop buttons must be pressed and left activated.*

*The machine must not be left off with the electronic board and the remote control powered.*

#### 11.4.6. Travel

The MEWPS is a self-propelled machine able to easily move on any type of ground, able to pass slopes and, considering the small dimensions, to enter narrow openings. A condition for traversing is that the four outriggers are lifted from the ground and the machine is in the transport or stabilisation configuration.



*For the translation the control position on the ground is foreseen.*

When controlling the machine, before traversing, make sure that the control position guarantees an optimal view of the entire machine and EVERY obstacle that may be in the trajectory to be followed by the machine. If a very precise control of traversing movements is required, engine rotation can be reduced by acting on the speed selector button on the remote control "Push buttons (p. 61)". Pay attention to the complete clearance of the machine especially if the outriggers are not turned into the transport position.



*It is prohibited to climb onto or off of the basket if it is not completely lowered.*



*The machine is not type-approved for road circulation. The work and autonomous shifting areas must be appropriately delimited and with signs according to the laws in force regarding this subject. The machine must be loaded onto type-approved machines for any movement on public roads.*



**DANGER**

- **During control operations, remember always to stay at a minimum distance of 1 metre from the machine.**
- It is advised to traverse on flat surface with the outriggers completely lifted and placed in the transport position in order to reduce overall clearance of the machine.

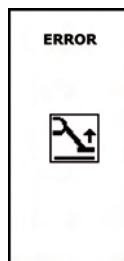
- It is mandatory to make new traversing movements positioning the carriage at maximum width, every time the place you are traversing allows it. This will make steering easier and increase machine stability.
- The second travel speed can only be used during straight, flat traversing on solid ground.

#### OPERATIONAL PHASES FOR TRAVEL

- a Before travelling, proceed as follows:
  - Check that all instructions previously given in this chapter have been complied with;
  - Make sure that the ground is compact and can support the weight of the machine;
  - Check that there are no obstacles in the travel area, considering the overall dimensions of the machine;
  - The machine is completely closed and aligned, in the transport or stabilisation position or with the JIB arm partially or totally lifted in the transport or stabilisation position. This configuration is **only allowed when strictly necessary**.
- b Select the travel speed according to the need and as described above, operating the relevant button and checking the selection on display;
- c Operate joysticks 1 and 8 to move the tracks;

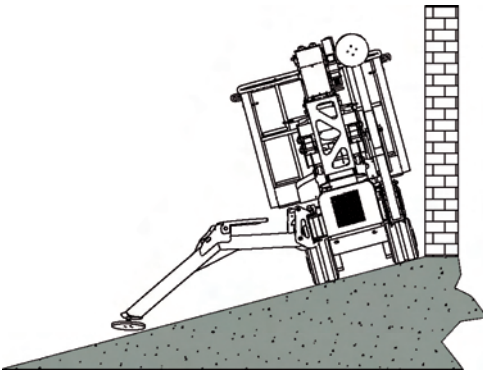


*If the operator attempts to travel with one or more stabilisers on the ground, an error message will appear on the display warning the user to raise the stabilisers in order to allow the machine to travel.*



**Fig. 87** Error, raise the outriggers from the ground before travelling

## TRAVELLING ON SLOPES



The maximum slope for travel is shown in the machine specifications at the beginning of this manual "Technical data (p. 19)". When travelling on inclined surfaces, lower the stabilisers on the downward side for further safety in the event of sudden changes in slope.



*The machine is equipped with an automatic system of inclination sensing during translation, the possible translation speeds are adjusted according to the weight in basket, undercarriage closed or opened, position of JIB and inclination of the ground. In case of approach to dangerous inclinations for machine's stability, both lateral and longitudinal, a beeper is activated and afterwards the translation is forbidden. The only allowed operation to exit this condition is activate the consent to movement pressing button 8 on remote control and bring the machine in safety condition reducing the inclination, it is absolutely forbidden to increase the inclination of the machine as it could cause overturning with consequent danger for operator or people nearby the machine.*



*The safety systems introduced to limit the risks of the manoeuvre are a valid help to the operator but unfortunately cannot eliminate dangers caused by improper or regardless use of the machine. It is operator's responsibility to run the machine safely, checking the ground conditions, evaluating the obstacles and dangers in the working area and following the rules of this manual and indications on decals and display of the machine.*

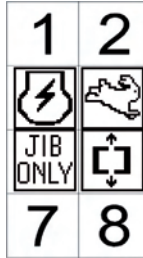
#### 11.4.7. JIB boom movement for travel

To take on slopes from 10° to 15° in a longitudinal direction during travel, the JIB arm can be raised.



*Perform this operation only when really necessary. In all other situations, travel with the machine closed and aligned.*

Enabling of the JIB is indicated by the icon in position 5 on the remote control.



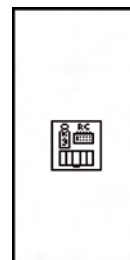
**Fig. 88** Consent to use JIB during travelling

The JIB arm can be raised during travel only from the control position on the ground.

Before raising the JIB boom for travel, check the following conditions:

- All the stabilisers must be lifted from the ground;
- No operators must be in the basket;
- The control position on the ground must be used (the remote control must not be in place in the basket);
- The aerial part safety device bypass key must not have been activated after the machine has been closed and aligned.

If one or more of these conditions is not satisfied, the JIB boom cannot be used and one of the following error screens will be shown.



**Fig. 89** Error machine not stabilized

After the conditions described above have been checked, make sure there are no obstacles in the working area of the JIB boom, and proceed as follows:

- Use joystick 6 to move the JIB boom "Fig. 53 Joystick controls(p. 60)". If another joystick is used, an error message will be shown on the display:

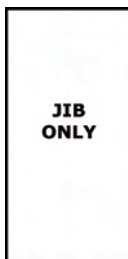


Fig. 90 Error JIB ONLY

- **After passing the incline that required the jib arm to be opened, return the machine to the closed configuration to continue travelling.**
- With the JIB boom raised always travel at minimum speed and keep the jib arm as close to the ground as possible.
- DO NOT travel downhill if the JIB boom is not completely folded.

#### *11.4.8. Parking the machine on a slope or on uneven ground*

When parking the machine on a slope or uneven ground with the stabilisers closed, make sure that the carriage is in the open position and block the tracks using chocks to prevent the machine from moving.

#### *11.4.9. Stabilising and levelling the machine*

Once having decided where to park the machine, this can be stabilised and levelled. First of all check that the surface can support the pressure exerted on the ground by the machine, see the paragraph "Technical data (p. 19)", and can contain the overall dimensions of the machine with stabilisers lowered.



*Stabilising the machine on a slope exceeding the allowed limits may cause instability and consequently harm to or even death of operators or other persons in and around the working area. Work must only be performed with the machine stabilised at an inclination under the limits specified by the manufacturer.*





*Always keep a distance from embankments or ditches that is equivalent to the depth of such and observe the required safety distance from power lines.  
Avoid any contact with objects or persons when lowering the stabilisers.*

## STABILISATION PROCEDURE

Before moving the stabilisers make sure that:

- All instructions provided in this chapter have been complied with
- The ground where the machine is stabilised is compact and can support the weight of the machine and the maximum possible reaction force on one stabiliser;



*When working the load on one individual stabiliser can increase greatly due to the shifting of weight, especially if extension and/or rotation operations are performed. THIS MUST ALSO BE CONSIDERED WHEN EXAMINING THE GROUND.*

- there are no obstacles on the stabilisation area and in the trajectory of each individual stabiliser;
- the machine is completely closed and aligned, in the stabilisation position.



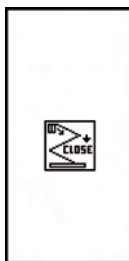
The complete closure and alignment is displayed by the arrows on the machine and the display of the icon in position 6 on the remote control "Fig. 42 Aerial part closed and aligned(p. 57)".

**Fig. 91** *Arrows feedback alignment*

- Stabilisation can be carried out from the control position in the basket or on the ground. If performing the operation from the ground, make sure there is complete visibility of the trajectory of each individual stabiliser before moving it and check that at the end of the stabilisation procedure the distance between the

ground and the lower limit of the basket access ladder is less than 40 cm. If this is not the case, move the ladder to the ground and carry out the stabilisation procedure from the basket.

- Select the motor speed as required and check the selection on the display. Always perform stabilisation at slow speed.
- Press and hold the automatic stabilisation button 7 "Push buttons (p. 61)". If the movements are selected with the machine not completely closed and aligned, an
- error message will be shown on the display.

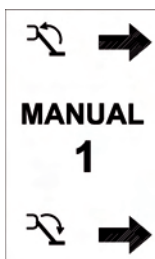


**Fig. 92** *Error close machine*

- Stabilisation will be completed when the machine is in horizontal position with tolerance of  $1^\circ$  and lifted at least 5 cm from the ground. Correct stabilisation will be confirmed by the icon in position 5 on the display "Fig. 39 Stabilized machine(p. 56)". Always check the spirit level and make sure the slope is actually less than  $1^\circ$ .

## MANUAL STABILISER CONTROL

The manual control of the stabilisers must not be used to stabilise the machine but only to correct its inclination in the event of stabilisation in difficult conditions. It can also be used to lower or lift the stabilisers individually in order to increase the stability of the machine, if it is necessary to transit areas with obstacles or steep slopes.



**Fig. 93** *Manual stabiliser selection*

Pressing the button once shows the screen for the manual operation of stabiliser 1, pressing it a second time shows the screen for stabiliser 2 and so on until stabiliser 4. Pressing it once again shows the initial display. In the manual menu, pressing buttons 1 and 7 raises or lowers the selected stabiliser. To verify the inclination of the chassis a spirit level is provided on the machine; when the air bubble it contains is completely inside the green area (see photo below) the machine is in conditions that allow operation.

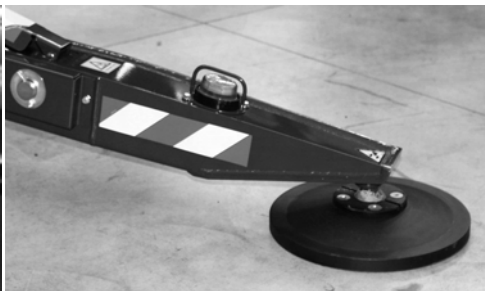
Please note that stabilize the machine on slopes greater than allowable limits (see technical data of the machine "Technical data (p. 19)") does not permit correct stabilization and is a serious danger for users.

On each stabiliser (see photo below), near the cylinder coupling, there is an orange light. This light flashes to indicate that the stabiliser is resting on the ground.

**An electronic level on the electronic control board checks that the machine is effectively levelled within the allowable tolerance and enables the movements of the aerial part.**



**Fig. 94** *Visible spirit level*



**Fig. 95** *Indicator light plate on the ground*



*It is important to remind that when the stabilisers are lowered the carriage must always be raised from the ground.*



*After using the manual stabiliser control, remember to pressurise the bottom of the stabiliser cylinders. To do this, run an auto-stabilisation cycle or lower each stabiliser for one second.*



*Incorrect machine stabilisation does not ensure suitable stability to perform operations. The Constructor prohibits the use of the machine if it is not stabilised as described in this manual; the machine overturning may cause serious injury to or even death of its occupants and personnel on the ground.*



*If one of the orange lights positioned on each stabiliser should flash even when the stabiliser is lifted from the ground, stop the machine immediately and call the after-sales service as this signals the breakage of the corresponding stabiliser micro switch.*



*If working with the machine stabilised on slippery surfaces (marble, porphyry, polished cement, smooth damp surfaces etc.) check that the movements of the basket do not cause the tracks to move. If so, stop the operations and restore the safe operating conditions prescribed by the manufacturer.*

*Make sure that the stabilisers rest on horizontal ground.*

**DO NOT REST THE STABILISERS ON VERTICAL OR INCLINED SURFACES.]**

#### **11.4.10. Automatic lowering and raising of the stabilisers**

The elevating platform is fitted with an innovative automatic levelling procedure that acts on the stabilisers and uses the electronic spirit level provided on the main control board. For the self-levelling procedure, all the precautions described to this point apply. Before starting the self-stabilization make sure that the machine is on a slope less than the total permitted limit for stabilization "Technical data (p. 19)" and verify that the trajectory of the stabilizers is free of obstacles and impediments.



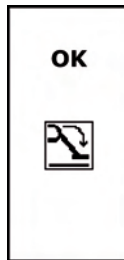
*The automatic procedure for levelling the machine extends and retracts the stabilisers, and consequently moves the machine. Always check that there are no people, animals or things in the stabilisation area.*

## AUTOMATIC LOWERING OF THE STABILISERS



Press and hold button 7 on the remote control.

The success of the self-levelling procedure is confirmed by an icon displayed on the screen for several seconds.




**Fig. 96** *Auto-Stabilization completed successfully*

If the self-stabilization procedure has not been completed and the OK message has not appeared on the display it will not be possible to move the aerial part of the machine and at every attempt to do it an error message will appear: AUTO-STAB NO. Repeat the Self-stabilization operation to enable movements.

**After the end of the procedure, always control that the spirit level is in the green zone. If this does not occur contact the after sales service.**

If during lowering one of the stabilisers does not touch the ground, the machine will continue to operate the cylinder at the end of its stroke until the motor switches off or the self-levelling procedure ends. This situation is normal and indicates that the slope the machine is situated on exceeds the allowable limit for

stabilisation. If at the end of the stabilisation phase the machine has to be lifted even further from the ground, a new self-levelling procedure can be run.

 *Using the self-levelling procedure does not affect the operation of the stabilisers in manual mode.*

## AUTOMATIC RAISING OF THE STABILISERS



Press and hold button 1 on the remote control.

The four stabilisers will start to lower the machine and then will retract completely. The automatic stabiliser raising procedure can still be considered completed once all the four stabilisers have been completely retracted and consequently the relevant cylinders are at the end of their stroke.



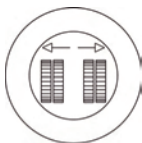
*If problems occur during either of these procedures, immediately release the selected button to stop all the movements. Stabilising the machine on a slope exceeding the allowed limits may cause instability and consequently harm to or even death of operators or other persons in and around the working area. Work must only be performed with the machine stabilised at an inclination under the limits specified by the manufacturer.*



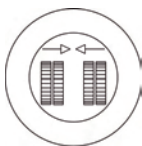
*The elevating platform is considered stabilised when the slope is less than 1° and the tracks are raised at least 5 cm from the ground. Never work at a height with the tracks not completely raised from the ground.*

### 11.4.11. Track extension

To adjust the track gauge, proceed as follows:



Press and hold button 3 on the remote control for extend the track.



Press and hold button 9 on the remote control for narrow the track.



*The track extension operations should be performed with the machine stabilised and lifted from the ground. If this is not possible, perform the extension operations with the tracks moving.*

**11.4.12. Moving the basket**

Once the machine has been stabilised correctly, check the icon in pos. 5 "Fig. 39 Stabilized machine(p. 56)", the basket can be moved.



**DANGER**

It is prohibited to load material of any type into the basket if the machine is not stabilised and completely closed. To load and unload the basket the icon in position 6 on the remote control must be displayed "Fig. 42 Aerial part closed and aligned(p. 57)". Loading material into the basket when it is lifted (e.g. from roofs, balconies etc.) causes the machine to overturn, exposing the occupants and personnel on the ground to potential risk of death.

It is absolutely forbidden to use the machine to lift loads both in the basket and connected in other way to the structure; the machine can lift two persons and their tools. See "Technical data (p. 19)" for data related to the admitted load on basket.

During machine lowering, near where the upper arms rest on the lower ones, a potential shearing risk is created, appropriately signalled by stickers; it is the user's responsibility to move any persons away from this area.



**Fig. 97** Example potential shearing risk zone 1



**Fig. 98** Example potential shearing risk zone 2



**Fig. 99** Example potential shearing risk zone 3

Pay maximum attention to obstacles that may collide with the various parts of the machine during movement. Before carrying out ANY movement, make sure that nothing can interfere with ANY part of the machine (branches, protruding parts of buildings, etc.).

It is prohibited to introduce objects into the basket that provide high resistance to wind pressure (e.g. large signs) even if they are within the machine's capacity limits.



## PROCEDURE FOR ROUTINE MOVEMENT OF THE AERIAL PART

- a** Before moving the aerial part, make sure that:
- All instructions provided in this chapter have been complied with.
  - There are no obstacles in the work area.
  - All the conditions necessary for working at a height are met.
  - The machine is stabilised and levelled: icon 5 shown on the display.
  - The weight in the basket is below the maximum allowed.
  - The remote control is positioned in the basket.
  - The basket access ladder has been folded into the raised position so as not to risk contact during movement of the aerial part.
- b** The aerial part can ONLY be moved from the control position in the basket.
- c** Select the motor speed as required and check the selection on the display.
- d** Use joysticks on the remote control to move the aerial part as described in the paragraph regarding the description of the controls "Joystick (p. 59)".
- e** If the movements are selected when one of the conditions listed above is not satisfied, an error message will be shown on the display indicating what conditions are OK and what are not satisfied (FAIL). If the missing condition is stabilisation, the message will also indicate what stabiliser is not resting on the ground.



**Fig. 100** Error machine not stabilised

ST1: if OK stabiliser 1 is resting on the ground

ST2: if OK stabiliser 2 is resting on the ground

ST3: if OK stabiliser 3 is resting on the ground

ST4: if OK stabiliser 4 is resting on the ground

INCL: if OK the machine is under the maximum inclination limit

LOAD: if OK, the load is less than the maximum working load allowed

BASKET: if OK the remote control is in place in the basket

PEDAL: if OK the foot switch is pushed

OVERLOAD ALARM

If during the basket loading phases the max allowable load is exceeded based on the position of the JIB boom, all movements of the aerial part will be disabled and an error message will be shown on the display, first on the entire screen and then in position 5.



**Fig. 101** *Overload alarm*

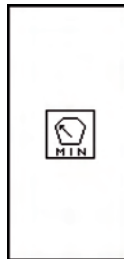


**Fig. 102** *Overload*

The alarm will only be reset when the overload is removed. Normal machine operation can be resumed only then.

BASKET LIFTING ALARM

If when using the machine at a height, for whatever reason, the basket is lifted from its position on the load sensor, an alarm prevents all movements of the machine and the display on the remote control shows an error message.



**Fig. 103** *Basket lifting alarm*

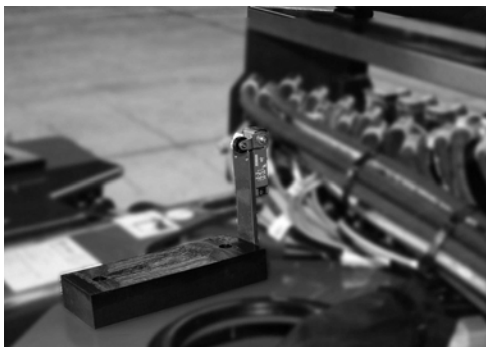
The alarm is reset only when the basket is fitted back on the load sensor.

## ROTATION WITH 1°-2° BOOM FOLDED AND 1°-2° BOOM DESCENT ON THE THERMIC/LITHIUM ENGINE

If the turret is rotated with the first or second boom folded or nearly folded, there is the risk of the first boom hitting against the engine / battery pack. For this reason, free rotation areas and limited rotation areas are defined. When using the machine from the remote control is not possible to enter in the limited rotation area. If you arrive in the vicinity of one of these areas the movement in progress will be blocked and a message will appear on the remote display that indicates the possible movements in this situation, which allow you to go back in a zone of free rotation.

- **LIMITED ROTATION AREA:** is an area near the engine / battery pack where this may be hit by the first boom.
- **FREE ROTATION AREA:** is the rest of the rotation area that does not coincide with the limited rotation area.

These two areas are identified through the combined control of two sensors: a micro switch that verifies the height of the first and second arm, and a proximity switch mounted inside the turntable that senses the position of the turret while it turns.



**Fig. 104** 1° boom micro switch



**Fig. 105** Proximity sensor

### ***11.4.13. Manually levelling of the basket***

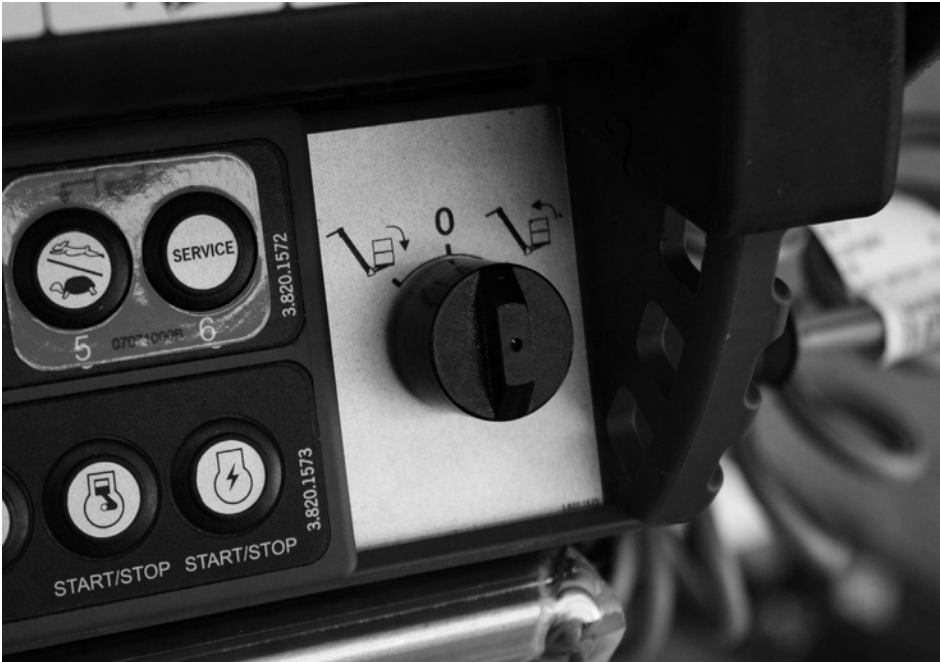
The platform has an automatic levelling device for the cage. This device has been designed in a way that the floor of the basket remains always parallel with the ground independently from the movements of the platform booms.

However, due to causes deriving from leaks and malfunctioning, it may be necessary to operate manually to take the basket to the optimal position. Act as follows to make this adjustment:

- try to take the basket to the traversing position by closing the extendable structure completely (this, only if the problem was met while the basket was at a high position);



- only carry out this operation if no basket levelling exceeds  $10^\circ$ . If this is not the case carry out manual levelling at minimum height possible, compatibly with the limit of  $10^\circ$ . The minimum height is reached by completely closing  $1^\circ$  and  $2^\circ$  boom, extension, jib and when possible the  $3^\circ$  boom;
- introduce the key into the relevant slot in the remote control;



**Fig. 106** *Levelling basket key*

- Rotate the key in the direction related to the necessary movement;



*levelling of the basket is only envisioned as an exceptional manoeuvre in the case of slight malfunctioning of automatic levelling, therefore if the problem should be repeated frequently, have the basket checked by an authorised workshop;*



*the manual levelling control is only allowed from the basket, with the extendible structure completely closed and aligned. Differently, the operator could be seriously injured by contact with moving machine parts;*



*it is prohibited to use the levelling manoeuvre for different aims than those described (e.g. to lift objects, too increase the working reach of the platform etc.), similar use could cause serious even fatal accidents.*

## 11.5.AERIAL PART EMERGENCY MANOEUVRES

The machine has been designed also considering possible emergency situations such as mechanical and electrical breakdown, sudden indisposition of the operator etc. In all of these cases interventions can be made on the machine from the basket and from the ground in a way to take the machine back to the transport configuration or however into a way to be able to rescue the occupant/s from the basket. The intervention procedures are given below.



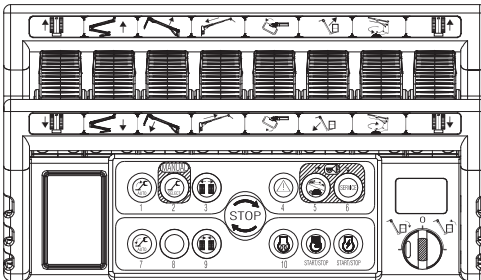
*Remember that the presence of staff on the ground is mandatory during platform functioning.*



*The manoeuvres described below must be performed in SEQUENCE starting from the first paragraph and passing to the next ones till the last one only if the emergency manoeuvre that is being performed is not functioning.*

### 11.5.1.Activation of emergency descent from the basket

The emergency descent procedure of the basket can be actuated from the basket itself only if the machine electric plant is not compromised; act in the following way:



- 1 Hold down button 4 on the remote control

Fig. 107 Remote control

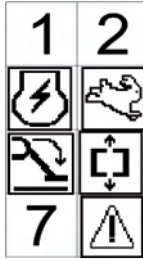
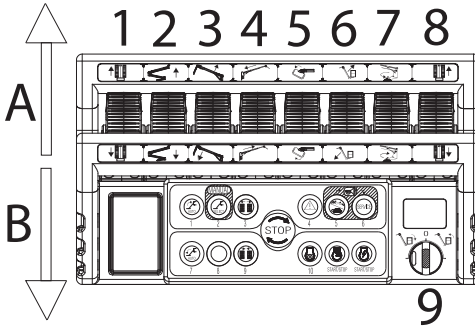


Fig. 108 Display icons

- 2 Check the control by means of icon 8 on the display



- 3 Activate the joystick relative to the arm that is to be closed until the desired height is reached and release the button 4

Fig. 109 Joystick controls

As descent is due to gravity, the platform and basket cannot be rotated and the telescopic boom cannot be extended or retracted, therefore the basket is lowered vertically at a distance from the centre of rotation that depends on the configuration of the machine at the time when the emergency situation occurred.



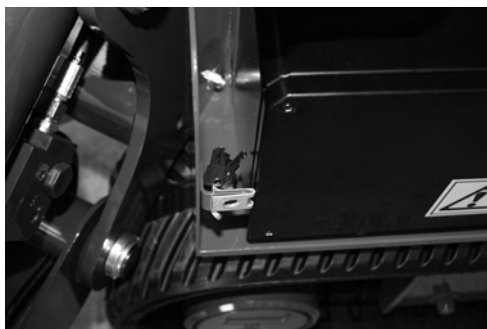
If a joystick corresponding to a movement without emergency descent, is activated an error icon will be shown on the display that disappear when the joystick is released.

### 11.5.2. *Operating the machine from the emergency control position on the ground if the operator is taken ill*

This function is only used if the operator in the basket becomes suddenly ill and unable to perform ordinary movements and the emergency descent of the basket.

**The sole purpose of the emergency descent from the ground is to operate in the event of system breakdown and to bring the basket to the ground, all other uses are prohibited.**

For information on the controls in the emergency position, see the paragraph "Emergency position controls (p. 74)"



**Fig. 110** *Emergency key location*

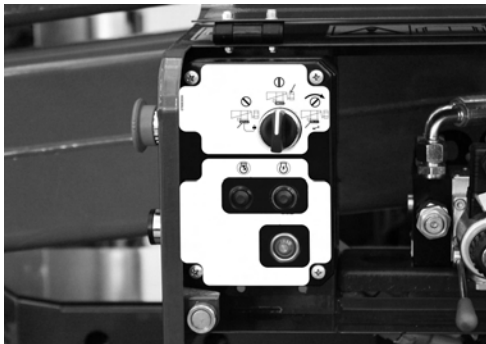
- 1 Withdraw the key enabling the emergency descent and a key opening the distributor controls' protection, if any, from the engine keys group inside the electrical components compartment.



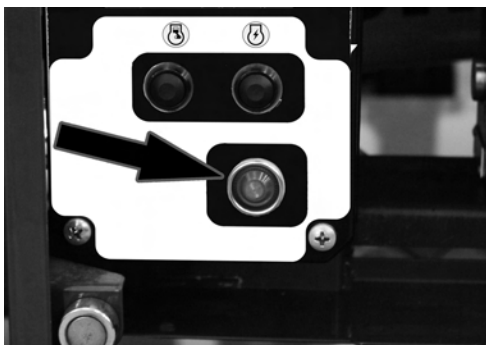
**Fig. 111** *Aerial part distributor protection*

- 2 Insert the key to open the distributor's controls protection and access the controls.



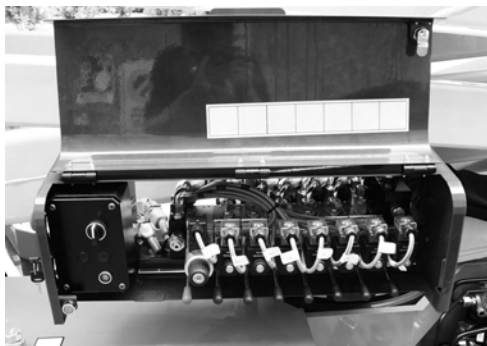


**Fig. 112** *Emergency control panel switch and buttons*



**Fig. 113** *Emergency control panel lamp*

- 3 Operate on the enabling selector in the control panel of the emergency position, rotating it clockwise and keeping it in position (in the Lithium version this starts the engine). Start the motor using the corresponding button in case of Petrol/Diesel version. If the switch needs key to be operated withdraw it from the engine keys group.
  
- 4 Make sure that the green indicator light on the emergency position control panel comes on, i.e. that the conditions necessary to be able to move the aerial part are satisfied.



**Fig. 114** *Aerial part distributor controls*

- 5 Move the aerial part of the machine using the manual levers positioned on the distributor on the ground as described on the decal placed near them and as specified in this manual "Aerial part hydraulic distributor (p. 76)".

When the operators and the machine are in safety condition close the protection and put the keys back in their original position.

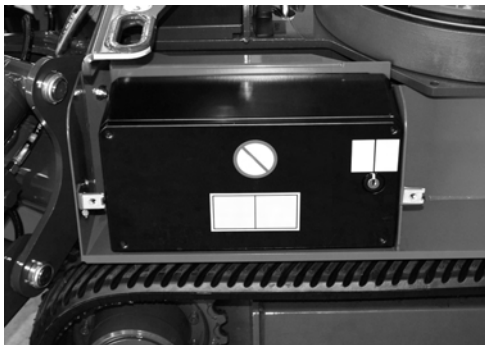
### 11.5.3. Emergency descent in the case where the stabilisers are accidentally retracted

While it is recommended to follow the instructions provided in the paragraph on stabilising the machine, for various reasons one of the stabilisers may lose contact with the ground, thus changing the angle of the machine or causing a foot plate to lift from the ground. If this occurs when the machine is at a height, movements are stopped and disabled immediately. To restore operation of the platform (close the aerial part and then stabilise the machine again) the electrical emergency descent function can be used, which involves only the return of the aerial part. If this is not possible due to the presence of objects that interfere with the operation, personnel on the ground can allow the operator in the basket to close the machine. The operators on the ground can bypass the machine's safety devices and allow the operator in the basket to close the machine or allow the manual operations as described in the previous paragraphs, in order to bring the operator back to the ground.



*Read the instructions provided below before performing the operation as it is potentially dangerous for the operator in the basket.*

Proceed as follows:



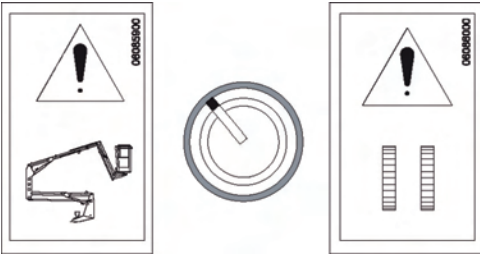
**Fig. 115** *Electric box*

- 1 Open the electrical components compartment.



**Fig. 116** *Emergency key location*

- 2 Position the emergency key on the electrical components compartment, removing it from the side where this is lead-sealed



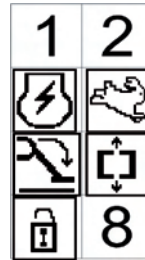
**Fig. 117** *Emergency BY-PASS decal*

- 3 Turn the emergency key anticlockwise and hold it in position

The display on the remote control shows the safety device BY-PASS icon.



**Fig. 118** *Emergency BY-PASS icon*



**Fig. 119** *Emergency BY-PASS activated*

**Control the machine with the remote control ONLY carrying out operations that allow the machine to be closed: first/second boom folding, extension boom in, JIB boom folding. The third boom can be rotated and lowered only with the extension boom completely retracted. Do not carry out any operations other than those listed or operations than may affect the stability of the machine. The arm movement sequence must be carried out in such a way as to avoid any operation that may affect the stability of the machine.**

When the operators and the machine are in safety condition release the key, remove it and put it back in its original position.



*The electronic control board records every time the safety device by-pass key is used.*

#### *11.5.4. Emergency descent controlled from the ground using the hand pump in the event of faults on all energy supply systems*

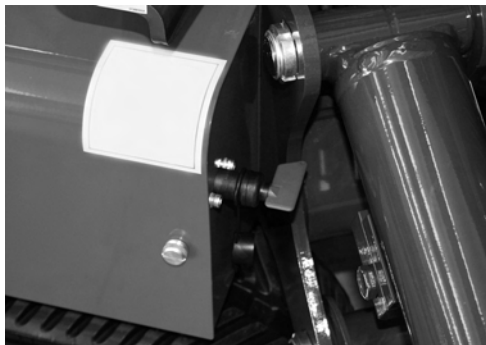
This emergency descent function is only used if the electrical system and motors break down, meaning one of the previous emergency operations cannot be performed.

**The sole purpose of the emergency descent from the ground is to operate in the event of system breakdown and to bring the basket to the ground, all other uses are prohibited.**

The emergency descent from the ground can only be carried out using the hydraulic hand pump; to move the basket, pump oil manually and simultaneously use the ground controls for the arm movements.

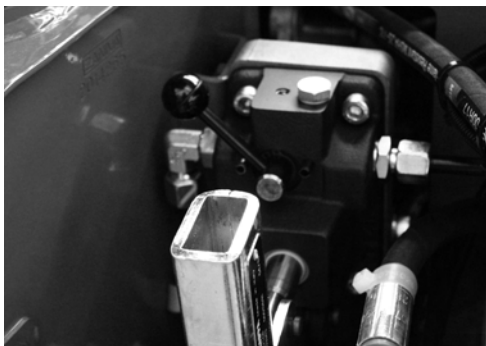
**During this procedure it is prohibited to perform any operations other than those described above, for example to extend the telescopic arm or the jib arm, to move the stabilisers and generally to perform operations that may cause the machine to lose stability.**

To perform the emergency descent in the conditions described above, proceed as follows:



**Fig. 120** *Battery cut out switch*

- 1 Position on OFF the engine key and disconnect completely the machine from the battery removing the battery cut-off.



**Fig. 121** *Hand pump manual selector*

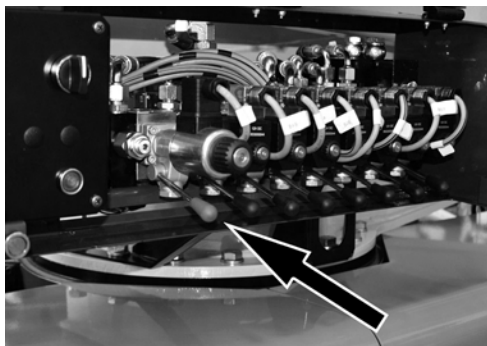


**Fig. 122** *Emergency key location*



**Fig. 123** *Aerial part distributor protection*

- 2 Remove the hand pump protection cover, whether there is. Move the manual selector located on the hand pump to the position corresponding to movement of the aerial part.
  
- 3 Withdraw the key enabling the emergency descent and a key opening the distributor controls' protection, if any, from the engine keys group inside the electrical components compartment.
  
- 4 Insert the key to open the distributor's controls protection and access the controls.



**Fig. 124** *Knob proportional valve aerial part enable*



**Fig. 125** *Aerial part distributor controls*

5 Activate the valve enabling knob.

6 Use the levers and/or buttons corresponding to the ON-OFF coils accessible from the bottom of the distributor protection so as to

enable the required movement, following the instructions on the sticker positioned near the controls "Aerial part hydraulic distributor (p. 76)" and at the same time operate the hand pump to obtain the movement. The sequence of movements is the following:

- retract extension boom
- fold JIB boom
- fold first-second boom
- fold third boom.

At the end of the emergency operation close the protection, remove the key and put it back in its original position. Remove the hand pump lever and put it back in its original position.



If this device has been used to move the machine, before using the machine again to work at a height it is compulsory to set it in the transport configuration (machine closed and aligned), to raise the stabilisers and lower them again. Only then it will be possible to work with the machine at a height controlling it from the basket.



*It is prohibited to release the aerial part proportional valve from the rest position with the motor running. This operation would be very risky for the safety of the operator on the platform.*

### 11.5.5. Emergency operation of the undercarriage in the event of movements of the aerial part

The manoeuvre described below must be carried out only and exclusively with the machine closed.

During transport, the aerial part of the machine may turn, consequently becoming misaligned. If this occurs, one of the two EMERGENCY PROCEDURES described below can be applied:

#### 11.5.5.1. Machine realignment

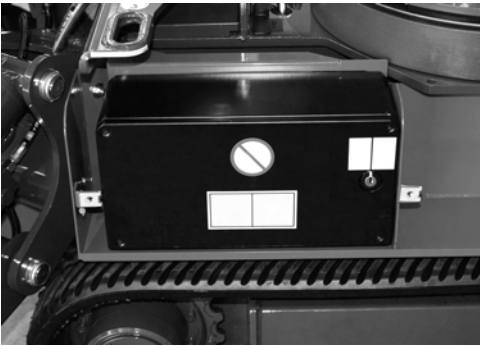


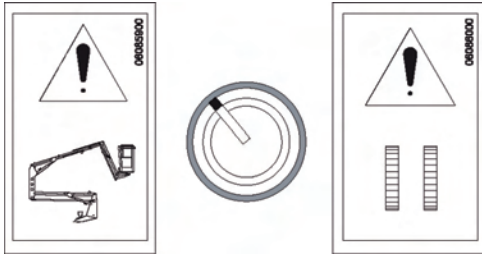
Fig. 126 *Electric box*

- 1 Open the electrical components compartment.



Fig. 127 *Emergency key location*

- 2 Place the emergency key on the electrical components compartment, removing it from the machine's key holder, where it is sealed with lead;



**Fig. 128** Emergency BY-PASS decals

- 3 Turn the emergency key anticlockwise and hold it in position;

The display on the remote control shows the safety device BYPASS icon.



**Fig. 129** Emergency BY-PASS icon



**Fig. 130** Emergency BY-PASS activated

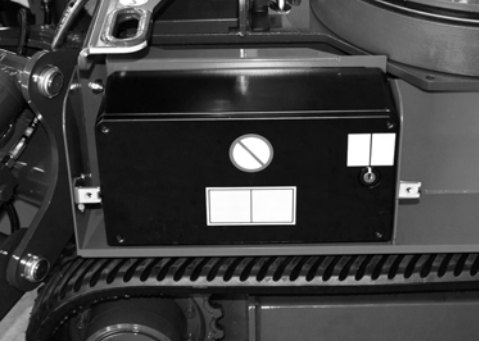


*Realign the machine, controlling it from the basket by means of the remote control.  
Perform exclusively the rotation manoeuvre.]*

Once the machine has been aligned, release the key, remove it, put it back in its original position and close the electrical components compartment.

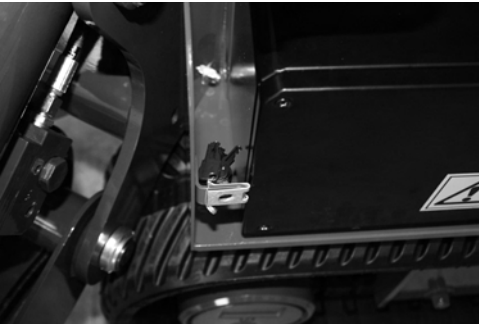
11.5.5.2. Moving the undercarriage with the machine not aligned

Operation allowed only to reach the conditions necessary to perform the procedure described in the "Machine realignment (p. 124)". Any other use is prohibited.



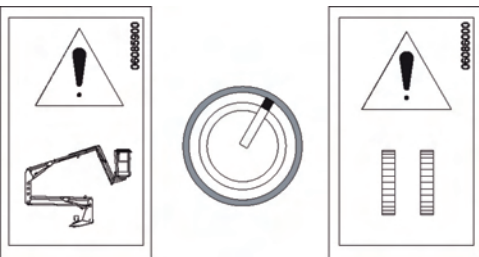
**Fig. 131** *Electrical box*

- 1 Open the electrical components compartment;



**Fig. 132** *Emergency key location*

- 2 Place the emergency key on the electrical components compartment, removing it from the machine's key holder, where it is sealed with lead;



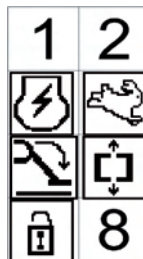
**Fig. 133** *Emergency BY-PASS decals*

- 3 Turn the emergency key clockwise and hold it in position;

The display on the remote control shows the safety device BYPASS icon.



**Fig. 134** Emergency BY-PASS icon



**Fig. 135** Emergency BY-PASS activated



*Use the travel control with extreme care to avoid causing damage to the machine or people. Move to a suitable position for carrying out procedure described in "Machine realignment (p. 124)", used to realign the machine.*

At the end of the operation release the key, remove it, put it back in its original position and close the electrical components compartment.

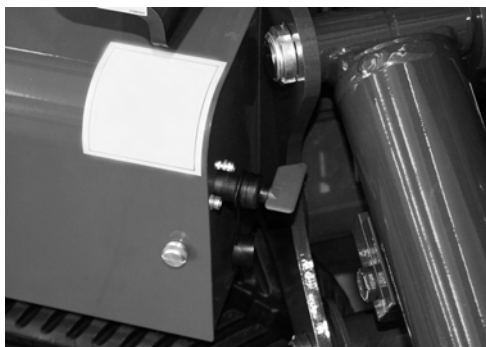


*The electronic control board records every time the safety device bypass key is used.*

### *11.5.6. Emergency operations on the carriage: moving the platform stabilisers using the hand pump to allow the machine to be transported*

The hydraulic hand pump can be used to move the stabilisers and set the machine in the transport configuration only after closing completely the aerial part of the platform.

To raise the stabilisers from the ground in order to be able to transport the machine, proceed as follows:

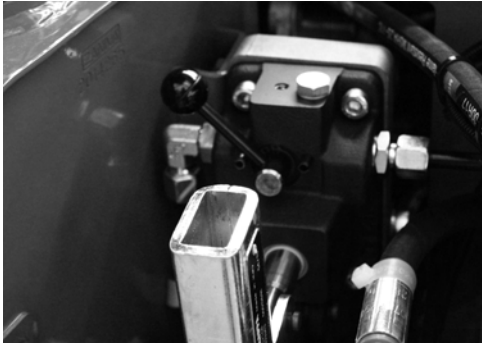


**Fig. 136** *Battery cut-out*

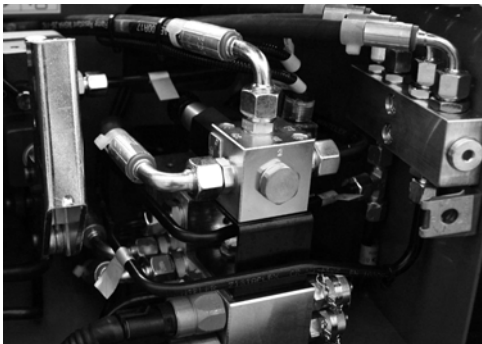


**Fig. 137** *Machine closed and aligned*

- 1 Place the emergency key on the electrical components compartment, removing it from the machine's key holder, where it is sealed with lead;
- 2 Check that the machine is completely closed and aligned;



**Fig. 138** *Hand pump manual selector*



**Fig. 139** *Aerial-tracked part switch*



**Fig. 140** *Knob proportional valve*

3 Remove the hand pump protection cover, whether there is. Move the manual selector located on the hand pump to the position corresponding to side of machine to move (right or left);

4 Manually switch the aerial-tracked part switch via the fuse in the centre of the magnet using the corresponding hand wheel;

5 Activate one of the proportional valve mounted on the two distributors through the proper devices;

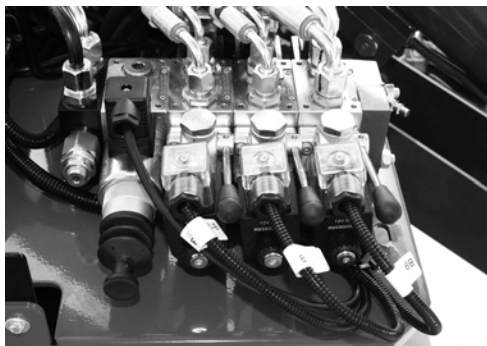


Fig. 141 Example distributor controls



Fig. 142 Hand pump

6 While keeping operated the proportional valve use the ON-OFF coil levers and buttons to enable the required movement "Tracked undercarriage hydraulic distributor (p. 79)";

7 Simultaneously operate the hand pump to deliver oil to allow the movement;

At the end of these emergency operations, close all the protection covers, fully unscrew the knob of the aerial part/undercarriage part switch and proportional valve and put the hand pump handle in the original position.



## 11.6.ELECTRICAL CONNECTION OF REMOTE CONTROL



*The electrical disconnection/connection of the remote control MUST be carried out exclusively with the motor key in position OFF and with the mains power disconnected.*

- Disconnect the cable from the remote control using the corresponding screw connection.



**Fig. 143** Remote control connection

- Make sure there is no moisture in the remote control connector and close the remote control sealing plug.
- Make sure there is no moisture in the electric cable connector and close the electric cable sealing plug.
- To reconnect the remote control, follow the same process in the reverse order.



*both connectors must be closed with the respective sealing plugs to prevent moisture from entering.*

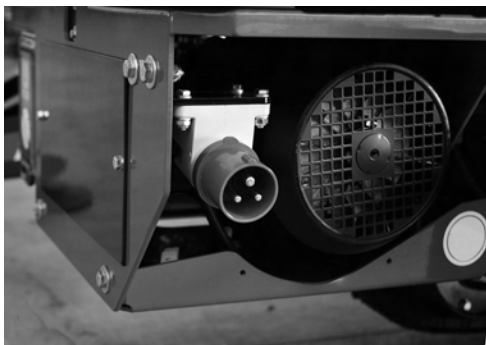
## 11.7.RECHARGING THE BATTERY

### 11.7.1.Battery charging Petrol/Diesel engine

The machine is equipped with a charging system of the battery. Using the Petrol/Diesel engine to a regime of revolutions exceeding 2200rpm the battery is recharged by the current generator. There is also the possibility of recharging the battery by the power supply.

To do this, proceed as follows:

- Check that the battery cut-out is connected.
- Power the machine by an electric cable connecting it to the socket on the chassis near the electric motor and activate the main supply switch in the control cabinet of the motor.



**Fig. 144** *Main supply socket*



**Fig. 145** *Main supply switch*

- In this condition the battery charger mounted on the machine recharges the battery.



*Recharging battery must be carried out in an ventilated area away from open flames or sources of ignition. In order not to cause damage to the battery is appropriate to recharge the same only when the ambient temperature is between 0 and 40 ° C*



*During charging, the machine must be continuously monitored by trained personnel.*

*Do not leave the machine in continuous charging for time periods exceeding 24 hours.*

*Pay attention, the charger works even if the electronic board of the machine is turned off. So the batteries can be charging even if the remote control is off.*

*Charge the machine using only the battery charger installed on it. The use of a charger other than that provided voids any kind of warranty on batteries and can cause damage to people or things*



*The battery charging from power supply works even if the machine is working with the electric motor running. Obviously the more features you use, the smaller the energy the charger will be able to provide to the battery. Consequently, the charging will be less efficient.*

### 11.7.2. Charging Lithium batteries

To check the battery charge, always use the special indicator shown on the display on the remote control "Display (p. 55)". The batteries can be recharged even when using the machine (obviously the recharging times in this case will be longer). The batteries can be recharged even when they are not completely down.

If the charge is less than 20% an audible warning signal will be activated whenever the electric motor is started, to warn the user to charge the machine. If the charge is less than 10%, in addition to the audible warning signal, reduced speed is activated and an icon comes on in position 4 "Fig. 38 Reduced(p. 56)".

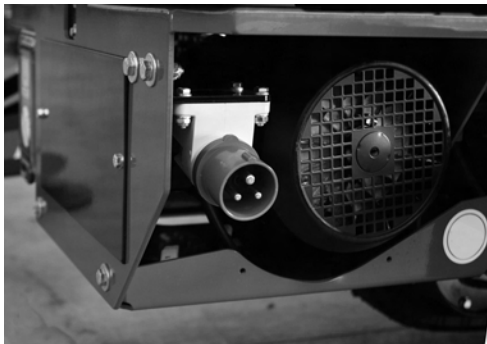


*During charging, the machine must be continuously monitored by trained personnel.*

*Do not leave the machine in continuous charging for time periods exceeding 24 hours. Pay attention, the charger works even if the electronic board of the machine is turned off. So the batteries can be charging even if the remote control is off.*

*Charge the machine using only the battery charger installed on it. The use of a charger other than that provided voids any kind of warranty on batteries and can cause damage to people or things*

To start recharging the battery simply connect the main power supply to the socket and close the circuit breaker.



**Fig. 146** *Main supply socket*



**Fig. 147** *Main supply switch*



If the machine is on, the display on the remote control also shows the machine recharge indicator.



Is also possible check the battery charging through the charge indicator located near the battery pack.



**Fig. 148** *Charging indicator*



The battery charger features just one charge curve (IU1a) plus balancing and maintenance, designed specially for recharging the battery pack of the elevating platform.

RED LED indicates that the battery is in the initial charging phase.

YELLOW LED indicates that the battery has reached 80% of recharge.

GREEN LED, staggered with red flashings, indicates that battery reached the balance/maintenance phase.



*The battery charger supplied with the elevating platform was designed to ensure safety and reliable performance. It is already fitted on the machine and does not need any adjustment or configuration by the user; nonetheless, to avoid injury and damage to the battery charger, the following essential precautions should be observed.*

To maximize the performance of the battery is recommended to charge via the network cable for at least 12 hours at least 1 time per month, even if the machine is not used.

- Carefully read the installation instructions contained in this manual. For future reference, keep the manual in a safe place.
- Do not place the battery charger near sources of heat.
- As the battery charger is sealed and without forced ventilation, its performance depends on the temperature and the type of installation.
- Make sure that the type of power supply available corresponds to the voltage specified and indicated on the battery charger rating plate or in this user and operation manual. In case of doubt, contact your reseller or the local electrical company.
- An AC class circuit breaker can be used as protection device for the battery charger power supply, however it is recommended to use a class A or class B device.
- With regards to safety and electromagnetic compatibility, the battery charger features a three-pins plug with earth, which can only be plugged into an earthed socket. If the plug does not go into the socket, most probably the socket is old and not earthed. In this case, contact an electrician to have the socket replaced.
- Do not use adapters to resolve earth plug problems.
- Make sure the power cable does not represent an obstacle. If the cable is worn or damaged, have it replaced immediately.
- If extensions or multiple sockets are used, make sure that these support the total rated current.
- Disconnect the power supply before connecting or disconnecting the battery.
- The battery charger installed was specially designed to recharge the type of lithium batteries used on the platform. Do not attempt to recharge any other type of batteries.
- Do not attempt to repair the battery charger. Opening the cover may expose the user to the risk of electric shock.
- Do not open the battery charger, opening it may affect the index of protection (IP) even after it has been closed again.
- If the battery charger is not working correctly or is damaged, disconnect it immediately from the power outlet and the battery socket and contact an authorized servicing entity.

## 11.8.MAIN INTENDED USES OF THE PLATFORM

Below are the specific warnings for the most frequent uses of the machine. The information provided must be considered as an addition to and not a replacement for the contents of the User and Operation manual.

### 11.8.1. *Systems*

Make sure the parts where maintenance is to be performed are not live, if in doubt request verification from personnel on the ground. Do not operate near power lines. Keep a suitable distance away based on the voltage see paragraph "Risk of electrocution (p. 82)".

### 11.8.2. *Closed environments*

To perform the operations in closed places the Constructor recommends the use of the machine with the electric engine. If this is not possible, make sure there is enough ventilation to prevent the accumulation of gases that are damaging to the health. If lighting in the workplace should be insufficient, additional lighting devices must be supplied.

### 11.8.3. *Pruning*

This activity requires very important skills in order to prevent the machine from losing stability. Remember that:

- if branches or logs fall on the safety devices these will be broken;
- falling plant parts may damage the machine;
- falling plant parts may press the emergency button on the ground. In this case the machine cannot be controlled and the personnel on the ground must intervene;
- the tools used for pruning, such as chainsaws, exert considerable force towards the outside of the basket edge;
- it is compulsory to check in advance that the plants being pruned cannot fall on any part of the platform or the basket.

### 11.8.4. *Repair and maintenance of roofing and gutters*

Remember that it is prohibited to use the platform for the transport of material at a height even if this is within the capacity limits specified by the manufacturer; the MEWP is not a lifting device. It is also very important to remember that once the basket has been lifted from the chassis it is prohibited to load objects. Remember that no safety device can help if the basket is overloaded at a height. The emergency descent procedure does not prevent overturning. The only way to

make things safe is to unload the basket and return as quickly as possible within the allowable limits based on the work configuration.

#### ***11.8.5. Painting, sand-blasting and plastering***

This type of use requires meticulous protection of the delicate parts of the machine such as hydraulic cylinder rods, gaskets, safety devices, hydraulic telescopic extension arms and markings on the machine (e.g. Rating plate, warning stickers, capacity table etc.). If sand enters the grease protecting the extension arms it produces an extremely abrasive mixture, affecting the quality of the movements and working life of the machine.

#### ***11.8.6. Use in marine environments***

If the machine is used in particularly corrosive environments and atmospheres, the formation of rust and the greasing and lubrication conditions of the moving parts must be checked more frequently than recommended by the manufacturer for normal operating conditions. It is also good practice to protect the machine carefully every time it is not used, even for short periods, by covering it to shield it against salt and sand carried by the wind.



## 12.MAINTENANCE

### 12.1.SAFETY INSTRUCTIONS FOR GREASING AND LUBRICATION



- Errors can be extremely dangerous. Before greasing or making repairs read the user and operation manual carefully.
- Handle all parts with special care. Keep hands and fingers away from concealed spaces, gearing and similar. Always use approved safety devices, such as goggles, gloves and safety footwear
- Do not dispose of lubricants in the environment but rather collect and dispose of them in compliance with laws in force in the country in question.
- It is prohibited to carry out any maintenance operations with the working arm not completely lowered and/or with stabilised machine.
- If operations are being carried out, apply a visible sign on the control position, stating "DANGER. Do not move the machine, service in progress".

#### *12.1.1. Table of recommended lbrificants*

##### ENGINE OIL (M)

For the petrol/Diesel engine we recommend the use of oil with the following characteristics

##### OIL HYDRAULIC DRIVE MOTORS (T)

For gear, we recommend the use of gear oils with EP additives viscosity class according to ISO VG150 or SAE 80W / 90 (-20 ° / +30 °) or SAE 85W / 140 (+ 10 ° / + 45 °).

##### GREASE BEARING AND IDLER (G)

When lubricating the slew ring and tensioning the rubber tracks we recommend the use of grease suitable for use in the construction equipment industry. Type EP NLGI 2 with the thickener base Soaps lithium or molybdenum disulphide.

HYDRAULIC OIL (I)

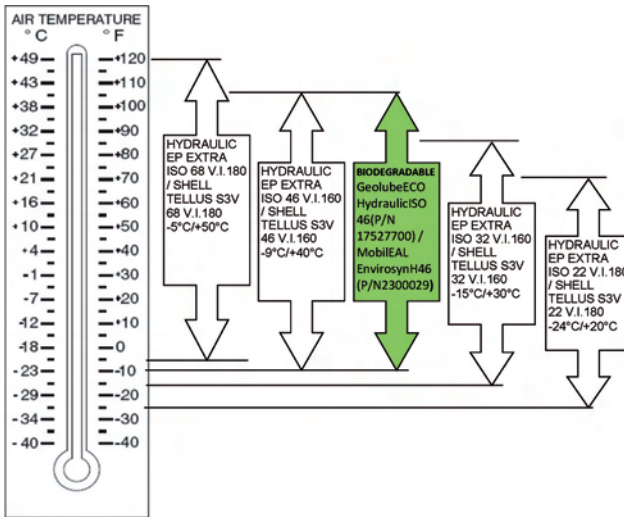


Fig. 149 Working temperatures used oil

Fluid Description	Proprieties		Base				Classifications		
	Viscosity at 40°C (cst,Typical)	Viscosity Index	Mineral Oils	Vegetable Oils	Synthetic	Synthetic Polyol Esters	Readily Biodegradable*	Virtually Non-toxic**	Fire Resistant***
Pakelo Hydraulic EP Extra ISO 68	68	180	X						
Pakelo Hydraulic EP Extra ISO 46	46	160	X						
GeolubeECO HydraulicISO 46 (P/N 17527700)	47.3	144				X	X		
Pakelo Hydraulic EP Extra ISO 32	32	160	X						
Pakelo Hydraulic EP Extra ISO 22	22	180	X						
SHELL TELLUS S3V 68	68	180	X						
SHELL TELLUS S3V 46	46	160	X						
MobilEAL EnviroSynH46 (P/N2300029)						X	X		
SHELL TELLUS S3V 32	32	160	X						
SHELL TELLUS S3V 22	22	180	X						

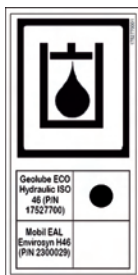
Fig. 150 Table of oils

\* Readily biodegradable classification indicates one of the following: CO2 Conversion > 60% per EPA 560/6-82-003 / CO2 Conversion > 80% per CEC-L-33-A-93.

\*\* Virtually Non-toxic classification indicates an LC50 > 5000 per OECD 203.

\*\*\* Fire Resistant classification indicates Factory Mutual Research Corp. (FMRC) Approval.

Flash point (C.O.C) for 68-46-32-22: 210°C.

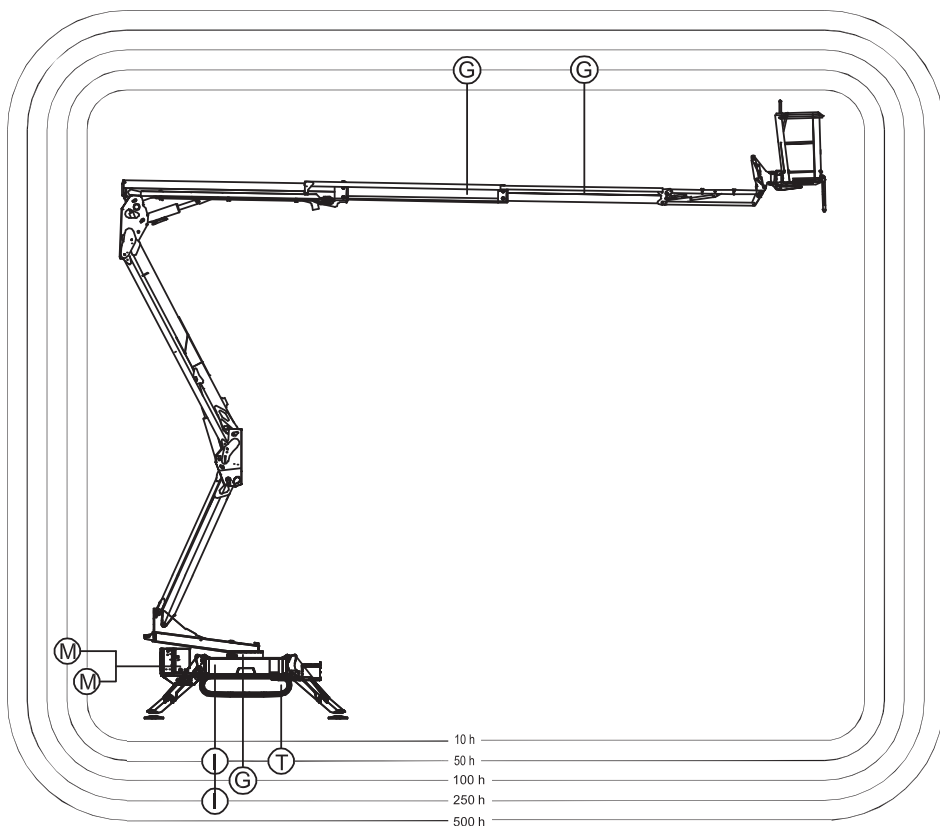


If the machine has been produced with biodegradable hydraulic oil in near the hydraulic tank filler cap is a decal indicating the type of oil used and those that are compatible in the case of refilling.



*When topping up or replacing hydraulic oil is recommended to use only products listed in this paragraph.*

12.1.2. Greasing points



**Fig. 151** Greasing points diagram



*Respect the greasing intervals indicated and use only the recommended lubricants in order to protect pins and connections from wear.*

12.1.3. Greasing the telescopic boom



Use a brush to apply grease onto the telescopic extension boom.

## 12.2.SAFETY INSTRUCTIONS FOR MAINTENANCE OPERATIONS



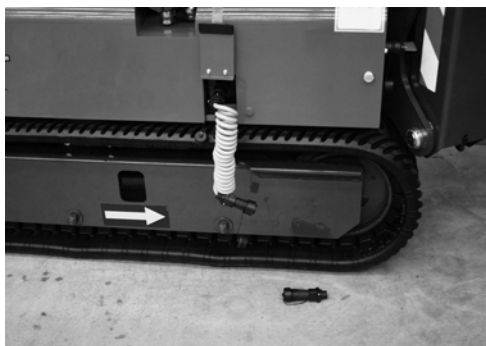
- Spare parts must correspond to the technical provisions established by the Constructor. This is guaranteed by the use of original spare parts.
- Errors can be extremely dangerous. Before greasing or making repairs read the user and operation manual carefully.
- Handle all parts with special care. Keep hands and fingers away from concealed spaces, gearing and similar. Always use approved safety devices, such as goggles, gloves and safety footwear.
- When working on the electrical system always wear protective goggles and remove rings, watches and any other metal jewellery. As a general rule, do not use petrol to clean parts.
- Always disconnect the batteries before working on the electrical system.
- Hydraulic hoses must be correctly laid and fitted.
- Tampering with the hydraulic circuit may cause serious danger during use of the platform.
- Do not dispose of lubricants in the environment but rather collect and dispose of them in compliance with laws in force in the country in question.
- Check the vehicle at least once per day or shift for any external damage (corrosion, structural parts, welds). The person in charge must be informed immediately of any change observed (including functional behaviour). In this case, stop the vehicle immediately and carry out more detailed checks.
- Fluid that leaks under pressure may penetrate the skin. Always discharge pressure before removing the hydraulic hoses and tighten connections correctly before pressurising. Keep hands and body away from small holes and nozzles where high pressure liquids may be released. Use cardboard or paper to identify leaks.
- Heavy parts must be lifted using a lifting device with suitable capacity.
- It is prohibited to carry out any maintenance operations with the working arm not completely lowered and/or with stabilised machine.
- If operations are being carried out, apply a visible sign on the start panel, stating "DANGER. Do not move the machine, service in progress".

### 12.3.MAINTENANCE CONTROL POSITION WITH REMOTE CONTROL FROM THE GROUND

As a control device for maintenance, you can use the remote control in the basket (or a second remote control optional) connecting it to the appropriate seat on the machine.

This type of operation is only allowed in case of machine maintenance by qualified personnel.

Proceed as follows to use this function:



**Fig. 152** *Kit use remote control from the ground*



**Fig. 153** *Position connector optional second remote*

- 1 If you have not already, or is not installed on the machine ask the kit to use remote control from the ground at an authorized service.
- 2 With the unit off (ignition key to OFF), connect the cable of the kit to the connector located in the electrical box under the guard. Now connect the remote to the cable service. If the kit is already installed on the machine connect directly the remote control to the cable service.

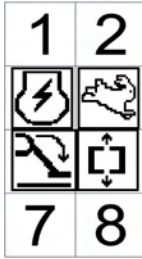


**Fig. 154** *Service connector on the basket*




**Fig. 155** *Basket/ground selector*

- 3 If you use the remote control to the basket as control device from the ground connect the remained free cable in the basket to the connector provided with the optional kit to use service from the ground. Otherwise, leave it connected to the main remote.
  
- 4 Select the command from the ground acting on the selector switch on the control box. The position rotated anti-clockwise switch enables the control station for maintenance if the remote control is connected to the ground.



**Fig. 156** *Ground remote control example visualization*

- 5 Start the machine, key in the ON position, check that the icons are correctly shown on the display on the remote control in the ground position. Now you can move the aerial part of the machine through the remote control to the ground as given in the paragraphs relating to the use of the machine "Remote control (p. 54)".

 *The remote control from the ground allows to perform all the operations possible within the safety limits if in the basket there is a load less than 50 kg. If the load in the basket exceeds 50 kg (always within the limits of the machine load), to use the remote control from the ground hold button 8 and then activate the required movement.*



***It 'absolutely forbidden to use the remote control from the ground to move the MEWPS if an operator is inside of the basket.***



12.4.PERIODICAL MAINTENANCE INTERVALS

Part	Operation	Before starting	As needed	10 H	50 H	100 H	250 H	500 H	1000 H	2000 H
Dry air filter (Petrol-Diesel)	Check, Clean	X								
	Replacement							X		
Engine oil (Petrol-Diesel)	Check level	X								
	Replacement				X*		X			
	Replacement (Kubota)					X				
Engine oil filter (Diesel)	Check, Clean					X				
	Replacement							X		
Engine oil filter (Diesel Kubota)	Check, Clean				X					
	Replacement						X			
Fuel filter (Diesel)	Clean	X								
	Replacement							X		
Coolin sistem (Diesel, if fitted)	Check level	X								
	Liquid add and replacement							X		

Part	Operation	Before starting	As needed	10 H	50 H	100 H	250 H	500 H	1000 H	2000 H
Water separator (Diesel)	Clean and draining water	X			X*		X			
Sump engine (Petrol)	Clean					X				
Fuel tank and net (Petrol)	Clean							X		
Hydraulic oil	Check level	X								
	Replacement								X	
Hydraulic oil filter	Replacement cartridge				X*		X			
Articulated joint points	Greasing				X*	X				
Battery	Check		X							
Reduction gear oil	Check level					X				
	Replacement				X*				X	
Machine	General periodic check								X	X*

Part	Operation	Before starting	As needed	10 H	50 H	100 H	250 H	500 H	1000 H	2000 H
Extension arm internal sliding ring (if fitted)	Check wear						X			
	Replacement								X	
Turntable bolt tightening	Check						X*	X		
Nut fixing pins basket Performance/ Plus	Check torque 50 Nm								X	
Nut fixing pins basket 3S	Check torque 200 Nm								X	
Extension ropes and pulleys (if fitted)	Check wear								X**	X*
	Replacement									X***

\* First operation.

\*\* At least every 3 months.

\*\*\* At least every 5 years.

Anyway every year. If the tightening is not correct replace the nuts with two new with the same specifications and restore the connection without using oil or grease.

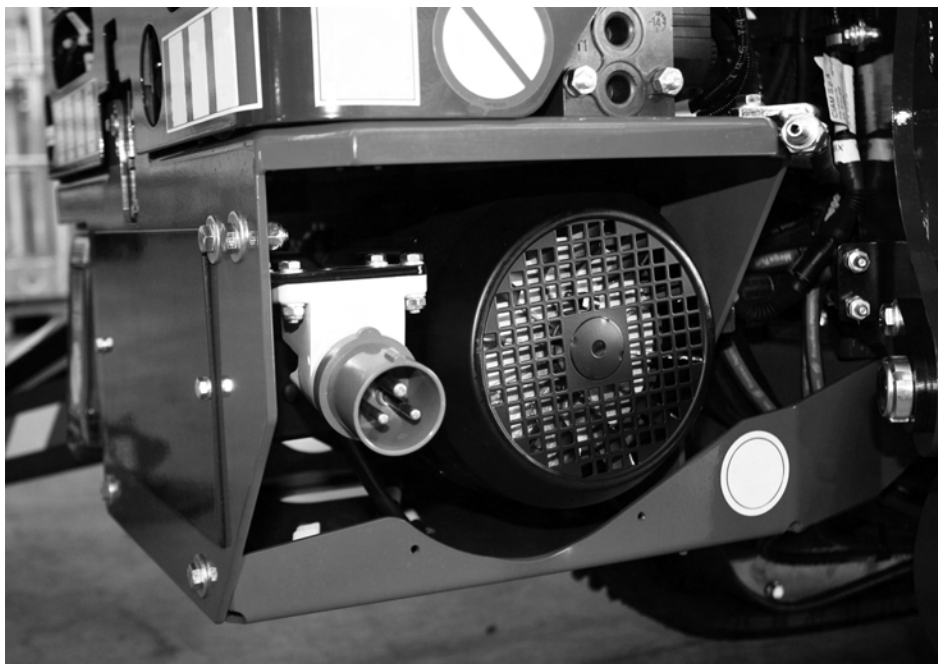
As regards complete service of the engine, see the manual supplied by the engine manufacturer or download it from the website:

[www.honda-engines-eu.com](http://www.honda-engines-eu.com)

[www.perkins.com](http://www.perkins.com)

## 12.5.ELECTRIC MOTOR MAINTENANCE

The electric motor is located under a protection cover on the chassis of the machine.



**Fig. 157** *Electric motor location*

Periodically check the condition of the following electric motor components.

- POWER SUPPLY TERMINALS
- Check tightness of the nuts on the power supply terminals and make sure the insulation is intact.
- FAN
- Keep air intakes clean and make sure the fan can rotate freely.
- BEARINGS

- Check the condition of the bearings, in the event of noise contact service department for replacement, as the life of the bearings is reduced significantly in heavy duty operating conditions.



*in the Lithium version the motor is "brushless" therefore no brushes need to be checked or replaced.*

## 12.6.INSPECTION AND MAINTENANCE INTERVALS

All aerial platforms must be inspected, tested and serviced according to the following instructions. See the user and operation manual for the complete list of recommended inspection intervals and the correct checking and servicing procedures.

### *12.6.1.A- Daily inspections before starting*

All the components that have a direct influence on the safe operation of the aerial platform and whose conditions may change from day to day must be visually inspected by the operator on a daily basis.

The following must be regularly inspected and must also be checked during operation and between regular inspection intervals:

- 1 Level of all fluids, such as fuel, engine oil, coolant and battery fluid.
- 2 Hydraulic hoses for leaks or loose connections.
- 3 All quick disconnection hoses for proper connection.
- 4 Structural components for obvious damage, broken parts, and cracks in welds.
- 5 Ladder or steps for damage and debris (ladders must be firmly secured to the platform).
- 6 Operating and emergency controls for proper functioning.
- 7 Placards and warning signs for cleanliness, readability of control signs, rated capacity, and operating manual.
- 8 Platform assembly for loose and missing parts, missing or loose lock pins and bolts.
- 9 Platform base for structural damage, holes or cracked welds, dirt, grease, or oil that can create a hazard.
- 10 Access ways for ease of movement.
- 11 Protection system operation.
- 12 Correct operation of the safety devices.
- 13 Correct operation of elevating, rotating, and drive functions.
- 14 Brakes.
- 15 Stabilisers.

### *12.6.2.B- Periodical inspections*

These inspections must be performed after 200 h of operation or every month, whichever comes first. The interval between inspections may vary depending on

the aerial platform's applications, severity of use, and working environment. Periodical inspections must be performed by a qualified operator.

These inspections must include those described in point A as well as, but not limited to, the following:

- 1 Loose bolts, nuts, and pins.
- 2 Hydraulic oil filters for cracks and leaks, pieces of metal on the filter that may cause pump, motor or cylinder malfunction; rubber particles on the filter that may indicate deterioration of hoses, o-rings or other rubber components.

Fuel filters.

- 3 Check belt radiator for regulation and excessive wear (diesel only).
- 4 Hydraulic hoses for cracks, leaks and buckling, and signs of excessive abrasion on all hoses and pipes.
- 5 Hydraulic pumps and motors for cracks or leaks, leaks at joints and gaskets, loss of operating speed, excessive heating of fluid, and loss of pressure.
- 6 Hydraulic cylinders for drifting caused by fluid leaks across the sealing valve or the piston, rod seal leakage, scored and damaged cylinder rods, and unusual noises or vibration.
- 7 All safety mechanisms for wear and response time.
- 8 Interlocks, gradient warning system, and limit switches.
- 9 All chain and cable mechanisms for setting and worn or damaged parts.

### *12.6.3.C- Annual inspections*

These inspections must be performed annually. A complete inspection of the aerial platform must be performed by a qualified operator. The inspection must comply with the requirements of points A and B and must include, but not be limited to, all critical and suspect areas and all accessible structural elements and welds, such as the following:

- 1 Stabiliser and stabiliser housing (boxes), including the underside of the housing.
- 2 Platform rotating, elevating, and levelling mechanisms.
- 3 Main turret rotating mechanism.
- 4 Brakes.
- 5 All secured points.
- 6 Arm sections, pins, cylinder rods, and levelling devices.
- 7 Switches for wiring and all electrical connections.
- 8 The constructor's outstanding safety bulletins.

#### **12.6.4.D- Structural inspection**

A structural inspection is required to verify the structural soundness of critical components of the aerial platform and must be performed:

- 1 10 years after the date of manufacture and every 5 years thereafter
- 2 After every accident that may actually, presumably, or potentially cause damage and affect the structural soundness or stability of the aerial platform. Such accidents include short circuits, impacts, falls, collisions, or cases of over-stress or stability failure.
- 3 After a change of ownership, unless a complete service history is provided, including maintenance and inspection records.

The structural inspection must be carried out under the supervision of a professional engineer.

This inspection must:

- 1 Consider the service history of the aerial platform in terms of hours of service, severity of use, and number and variability of users;
- 2 Review the inspection and maintenance record of the aerial platform;
- 3 Verify the efficiency of all operating controls;
- 4 Perform a visual inspection of the aerial platform;
- 5 Consider recommendations of the manufacturer regarding the aerial platform, including manufacturer's safety bulletins.

#### **12.6.5.E- Maintenance**

Before adjustments and repairs are started on the aerial platform, the following precautions must be taken:

- 1 The power system must be stopped, and the starting devices must be rendered inoperative;
- 2 All controls must be in the OFF position and all operating systems must be secured against accidental activation by brakes, chocks or other means;
- 3 Elevating and rotating assembly and platform must be completely lowered, if possible, or otherwise secured by blocking or propping;
- 4 The hydraulic oil pressure must be released from all hydraulic circuits before loosening or removing hydraulic components;
- 5 Safety props or latches must be installed where applicable;
- 6 Other precautions must be adopted as specified in the user and operation manual.



### **12.7.GENERAL PERIODICAL CHECKS**

**After the first 2000 hours of operation, have a general check run on the machine, at a certified service centre, where the general condition of the machine will be assessed and the form in Appendix 1 of this manual will be filled in. Subsequent checks should be performed every 1000 hours of operation. To find the nearest certified service centre, contact your reseller.**

12.8.MAINTENANCE ON RUBBER TRACKS

12.8.1. Rubber tracks tension check

Stop the machine on a flat and solid ground. Raise the machine off the ground safely and, if needed, support it by applying stable blocks or jack stands under the undercarriage frame. In correspondence with the undercarriage central roller, measure distance "A" of the bottom of the roller to the hard internal part of the rubber belt. Track tension is normal if measure "A" is between 10 and 15 mm. If the tension is not within the above measure, or too tight, please follow the procedure illustrated in the following paragraph.

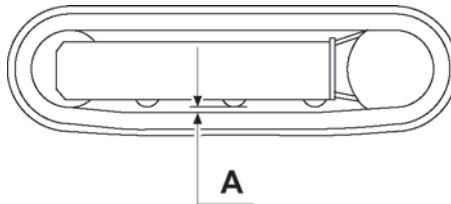


Fig. 158 Tensioning check 1

As an alternative to the above-mentioned procedure, you can follow the procedure below. In this case, the check is less accurate and precise. However, effective for evaluating if the rubber track is too slack.

Stop the machine on a flat and solid ground. In correspondence of the upper skid of the carriage, measure distance a of the bottom of the skid to the hard internal part of the rubber belt, lifting the belt manually. The track tension is normal if measure "A" is between 10 and 15 mm. If the tension is not within the above measure, or too tight, please follow the procedure illustrated in the following paragraph.

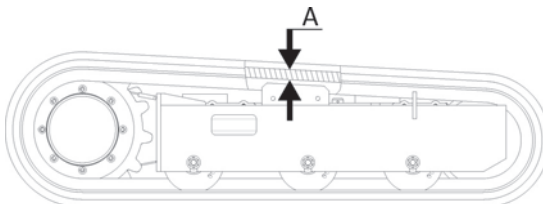


Fig. 159 Tensioning check 2

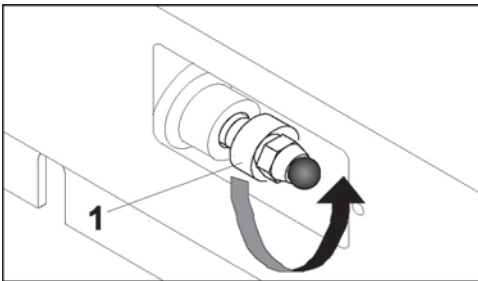
### 12.8.2. Tensioning rubber track



*The grease contained in the hydraulic tracks is under pressure. If the valve track tension is too loose, it could be expelled under the effect of the pressure of grease, seriously endangering the safety of the operator.*



*When gravel or mud is stuck between the sprocket teeth and track links, remove it before tightening the tracks.*



**Fig. 160** Tensioning valve

To tighten the tracks, connect a grease gun to grease fitting 2 and add grease until the track tension reaches the indicated values (preferably use a pneumatic pump with 100 bar operating pressure). Before start the machine clean up any grease spillage. For the choice of the type of grease to use, see "Table of recommended lubricants (p. 139)".

### 12.8.3. Removing rubber track

Stop the machine on a flat and solid ground. Raise the machine off the ground safely and, if needed, support it by applying stable blocks or jack stands under the undercarriage frame.



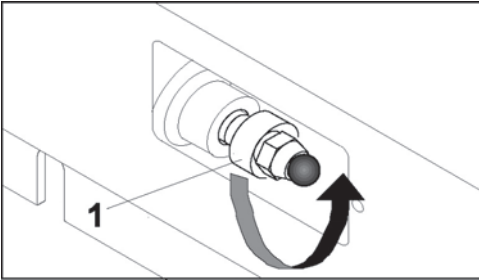


Fig. 161 Draining valve

- 1 To loosen the track, slowly unscrew grease release valve (1) counter-clockwise for no more than a turn. If the grease does not start drain, slowly rotate the track. If also in this case the grease not emerges repeat the rotation of a lap of the valve and then slowly rotate the track. Repeat these steps until the grease begins to drain by unscrewing the valve of not more than one turn at a time.



*The grease contained in the hydraulic tracks is under pressure. If the valve track tension is too loose, it could be expelled under the effect of the pressure of grease, seriously endangering the safety of the operator.*

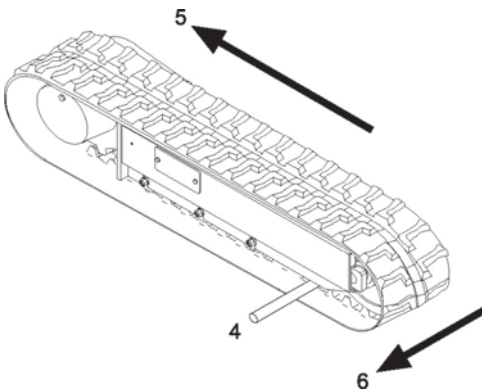


Fig. 162 Removing rubber track example

- 2 Use a pry bar (4) of adequate length to force a tooth of the central wheel out of the idler, then rotate the track slowly (5) using the pry bar to help it out, if necessary. Force (6) sideways to slide the track and lift it from the idler.

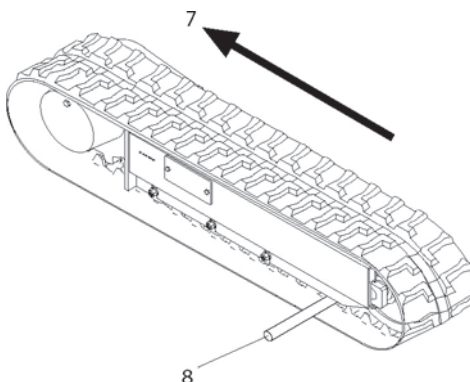
### 12.8.4. Installing rubber track

- 1 Starting with the machine undercarriage raised in conditions of safety provided of suitable supports stable below the undercarriage frame to support the machine.



*Before installing the rubber tracks, make sure that you are always in safe conditions with the machine suspended from the ground,*

- 2 Check that the grease contained in the hydraulic cylinder has been removed.
- 3 Mesh the track links with the track teeth of sprocket wheel and place the other end of the track on the idler.
- 4 Rotate the drive wheel to reverse slowly (7) pushing into the frame. If necessary, help yourself with a pry bar (8), especially to "walk" the first teeth in past the idler.



**Fig. 163** Rubber track installation example

- 5 Make sure that the track links are properly meshed in the sprocket and idler.
- 6 Adjust the track tensioning "Tensioning rubber track (p. 157)".
- 7 Lower the undercarriage down to the ground.

## 12.9. CHECKING TIGHTNESS OF NUTS AND BOLTS

Depending on the use of the platform, it is essential to check the parts and the nuts and bolts which are subject to loosening. Pay particular attention to the chassis components, such as idler roller, travel gear motors, sprockets and guide rollers. Check that they are tightened sufficiently, according to the following table.



*The values indicated are to be applied unless different instructions are given in this manual.*



*Pay special attention to the screws of the stop pins, the nuts of bolts and screws of the slew ring in both the top and the bottom.*

Values for Zinc Yellow Chromate Fasteners (Ref 4150707)

Size	TPI	Bolt Dia	Tensile Stress Area	Clamp Load	Torque (Dry)		Torque Lubricated		Torque (Locitite® 242™ or 271™ OR Vibra-TITE™ 111 or 140)		Torque (Locitite® 262™ or Vibra-TITE™ 131)		Torque (Locitite® 242™ or 271™ OR Vibra-TITE™ 111 or 140)		Torque (Locitite® 262™ or Vibra-TITE™ 131)		Torque (Locitite® 262™ or Vibra-TITE™ 131)		
					IN-LLB [N.m]	IN-LLB [ft.lbs]	IN-LLB [N.m]	IN-LLB [ft.lbs]	IN-LLB [N.m]	IN-LLB [ft.lbs]	IN-LLB [N.m]	IN-LLB [ft.lbs]	IN-LLB [N.m]	IN-LLB [ft.lbs]	IN-LLB [N.m]	IN-LLB [ft.lbs]	IN-LLB [N.m]	IN-LLB [ft.lbs]	IN-LLB [N.m]
4	40	0.1120	0.06504	230	8	0.32	0.7	0.7											
4.8	48	0.1120	0.06561	420	8	1.0	0.8	0.8											
6	32	0.1380	0.09509	800	18	1.8	1.4	1.4											
6.32	40	0.1380	0.10105	610	18	2.0	1.3	1.5											
8	32	0.1640	0.01400	900	30	3.4	2.2	2.5											
8	36	0.1640	0.01474	940	31	3.5	2.6	2.6											
10	24	0.1900	0.02000	1285	43	4.8	3.2	3.5											
10	32	0.1900	0.02000	1285	49	5.5	3.6	4											
14	20	0.2500	0.0362	2000	62	6.2	4	4.05											
14	28	0.2500	0.0364	2320	120	13.5	6.6	10											
			SAE Area	LB	FT.LB	IN-LLB	FT.LB	IN-LLB	FT.LB	IN-LLB	FT.LB	IN-LLB	FT.LB	IN-LLB	FT.LB	IN-LLB	FT.LB	IN-LLB	FT.LB
5/16	18	0.3125	0.1524	3550	13	13	13	19											
5/16	24	0.3125	0.0850	3700	16	26	13	20											
3/8	16	0.3750	0.0775	4840	30	4.7	2.3	3.1											
7/16	14	0.4375	0.0878	6800	35	4.7	2.5	3.4											
1/2	13	0.5000	0.1419	9050	75	10.2	5.5	7.5											
9/16	12	0.5625	0.1599	10700	90	12.2	6.5	8.8											
1	10	0.7500	0.2653	14900	110	14.9	8.0	11.3											
5/8	11	0.6250	0.2260	14400	150	20.3	11.0	14.9											
3/4	10	0.7500	0.2560	16300	170	23.0	13.0	17.6											
7/8	9	0.8750	0.3790	23800	300	40.7	22.0	29.8											
1	8	1.0000	0.5090	32400	470	63.7	35.0	47.5											
1 1/8	7	1.1250	0.6630	42300	800	108.5	60.0	81.3											
1 1/4	7	1.2500	0.8560	47500	880	119.3	66.0	89.5											
1 3/8	6	1.3750	1.1550	64100	1460	197.9	110.0	149.1											
1 1/2	6	1.5000	1.4050	78000	1940	263.3	146.0	197.9											
			1.5800	87700	2200	298.0	164.0	224.2											

NOTES: 1. THESE TORQUE VALUES DO NOT APPLY TO CADMIUM PLATED FASTENERS  
 2. ALL TORQUE VALUES ARE STATIC TORQUE MEASURED PER STANDARD AUDIT METHODS TOLERANCE = +10%  
 3. \* ASSEMBLY USES HARDENED WASHER

Torque Specs

SOCKET HEAD CAP SCREWS		Magni Coating (Ref 4150701)*				Zinc Yellow Chromate Fasteners (Ref 415070)*								
Size	TPI	Bolt Dia	Tensile Stress Area	Clamp Load See Note 4	Torque (Dry) K = 17		Torque (Loctite® 242™ or 271™ OR Vibra-TITE™ 111 or 140 OR Precoat 859) K=0.18		Clamp Load See Note 4	Torque (Dry) K = 20		Torque (Loctite® 242™ or 271™ OR Vibra-TITE™ 111 or 140 OR Precoat 859) K=0.18		Torque (Loctite® 262™ or 271™ TITE™ # 31) K=0.15
					IN-LB	[N.m]	IN-LB	[N.m]		IN-LB	[N.m]	IN-LB	[N.m]	
4	40	0.1120	0.00604											
	46	0.1120	0.00661											
6	32	0.1380	0.00909											
	40	0.1380	0.01015											
8	32	0.1640	0.01400											
	36	0.1640	0.01474											
10	24	0.1900	0.01750											
1/4	20	0.2500	0.03918	2860	122	114	13		2860	143	16	129	15	
	28	0.2500	0.03844	3280	139	131	15		3280	164	19	148	17	
5/16	18	0.3125	0.0524	4720	20	25	20	25	4720	25	35	20	25	
	24	0.3125	0.0580	5220	25	35	20	25	5220	25	35	20	25	
3/8	16	0.3750	0.0775	7000	35	50	35	50	7000	45	60	40	55	50
	24	0.3750	0.0878	7900	40	55	40	55	7900	50	70	45	60	50
7/16	14	0.4375	0.1063	9500	60	80	55	70	9500	70	95	60	80	70
	20	0.4375	0.1187	10700	65	90	60	80	10700	80	110	70	95	80
1/2	13	0.5000	0.1418	12750	80	120	65	80	12750	105	145	80	110	100
	19	0.5000	0.1560	14300	90	130	70	90	14300	110	150	90	120	110
9/16	12	0.5625	0.1820	16400	130	175	115	130	16400	155	210	140	190	155
	16	0.5625	0.2030	18250	145	195	135	155	18250	170	230	155	210	175
5/8	11	0.6250	0.2260	20350	180	245	170	230	20350	210	285	180	260	220
	18	0.6250	0.2560	23000	205	280	180	245	23000	240	325	215	290	180
3/4	10	0.7500	0.3340	30100	320	435	300	360	30100	375	510	340	460	380
	16	0.7500	0.3730	33600	355	485	335	455	33600	420	570	380	515	315
7/8	9	0.8750	0.4620	41600	515	700	485	620	41600	605	825	545	740	465
	14	0.8750	0.5090	45800	570	775	535	730	45800	670	910	600	815	500
1	8	1.0000	0.6060	51700	730	995	685	930	51700	860	1170	775	1055	645
	12	1.0000	0.6630	57900	845	1150	795	1080	57900	995	1355	895	1215	745
1 1/8	7	1.1250	0.7630	68700	1095	1490	1030	1400	68700	1310	1755	1160	1580	965
	12	1.1250	0.8560	77000	1225	1665	1155	1570	77000	1445	1965	1300	1770	1085
1 1/4	7	1.2500	0.9680	87200	1545	2100	1455	1980	87200	1815	2470	1635	2225	1365
	12	1.2500	1.0730	96600	1710	2325	1610	2190	96600	2015	2740	1810	2480	1510
1 3/8	6	1.3750	1.1560	104000	2025	2755	1905	2580	104000	2385	3245	2145	2915	1785
	12	1.3750	1.3160	118100	2300	3130	2165	2930	118100	2765	3685	2485	3310	2130
1 1/2	6	1.5000	1.4660	132000	2670	3595	2530	3360	132000	3150	4155	2860	3810	2460
	12	1.5000	1.5880	142200	3020	4105	2845	3870	142200	3555	4635	3200	4350	2865

NOTES: 1. THESE TORQUE VALUES DO NOT APPLY TO CADMIUM PLATED FASTENERS  
 2. ALL TORQUE VALUES ARE STATIC TORQUE MEASURED PER STANDARD AUDIT METHODS TOLERANCE = +10%  
 \*3. ASSEMBLY USES HARDENED WASHER OR FASTENER IS PLACED AGAINST PLATED STEEL OR RAW ALUMINUM  
 4. CLAMP LOAD LISTED FOR SHCS IS SAME AS GRADE 8 OR CLASS 10.9 AND DOES NOT REPRESENT FULL STRENGTH CAPABILITY OF SHCS. IF HIGHER LOAD IS REQUIRED, ADDITIONAL TESTING IS REQUIRED.

Torque Specs



		Values for Zinc Yellow Chromate Fasteners (Ref 4150707)										Spec #4150701				
		CLASS 8.8 METRIC (HEX HEAD) BOLTS CLASS 8 METRIC NUTS					CLASS 10.9 METRIC (HEX HEAD) BOLTS CLASS 10 METRIC NUTS					CLASS 12.9 SOCKET HEAD CAP SCREWS M6 AND ABOVE*				
Size	PITCH	Tensile Stress Area	Clamp Load	Torque (Dry or Loctite® 263™)	Torque (Lub) [N.m]	Torque (Loctite® 242™ OR Vibra-TITE™ 131)	Torque (Loctite® 242™ OR Vibra-TITE™ 131)	Torque (Loctite® 242™ OR Vibra-TITE™ 131)	Clamp Load	Torque (Dry or Loctite® 263™) K=0.20	Torque (Lub or Loctite® 242™ OR Vibra-TITE™ 111 or TITE™ 140) K=0.18	Torque (Loctite® 242™ OR Vibra-TITE™ 131) K=0.15	Clamp Load See Note 4	Torque (Dry or Loctite® 263™) K=0.17	Torque (Lub or Loctite® 242™ OR Vibra-TITE™ 131) K=0.16	Torque (Loctite® 262™ OR Vibra-TITE™ 131) K=0.15
		Sq mm	KN	[N.m]	[N.m]	[N.m]	[N.m]	[N.m]	KN	[N.m]	[N.m]	[N.m]	KN	[N.m]	[N.m]	[N.m]
3	0.5	5.03	2.19	1.3	1.0	1.2	1.4	3.13								
3.5	0.6	6.78	2.85	2.1	1.6	1.9	2.3	4.22								
4	0.7	8.78	3.82	3.1	2.3	2.8	3.4	5.47								
5	0.8	14.20	6.18	6.2	4.6	5.6	6.8	8.85								
6	1	20.10	8.74	11	7.9	9.4	12	12.5								
7	1	28.90	12.6	18	13	16	19	18.0	25	23	19	12.5	18.0	21	20	19
8	1.25	36.60	15.9	26	19	23	28	22.8	37	33	27	22.8	31	29	29	27
10	1.5	58.00	25.2	50	38	45	55	36.1	70	65	55	36.1	61	58	54	54
12	1.75	84.30	36.7	88	66	79	97	52.5	125	115	95	52.5	105	100	95	95
14	2	115	50.0	140	105	126	154	71.6	200	180	150	71.6	170	160	150	150
16	2	157	68.3	219	164	197	241	97.8	315	280	235	97.8	285	250	235	235
18	2.5	192	83.5	301	226	271	331	119.5	430	385	325	119.5	385	345	325	325
20	2.5	245	106.5	426	320	383	469	152.5	610	550	460	152.5	520	490	460	460
22	2.5	303	132.0	581	436	523	639	189.0	830	750	625	189.0	705	665	625	625
24	3	353	153.5	737	553	663	811	222.0	1065	960	800	222.0	900	845	790	790
27	3	459	199.5	1080	810	970	1130	286.0	1545	1390	1160	286.0	1315	1235	1160	1160
30	3.5	561	244.0	1460	1100	1320	1530	349.5	2095	1885	1575	349.5	1780	1680	1575	1575
33	3.5	684	302.0	1990	1480	1790	2090	432.5	2855	2570	2140	432.5	2425	2285	2140	2140
36	4	817	355.5	2560	1920	2300	2800	509.0	3665	3300	2750	509.0	3115	2930	2750	2750
42	4.5	1120	487.0	4090	3070	3680	4290	698.0	5865	5275	4395	698.0	4985	4690	4395	4395

NOTES: 1. THESE TORQUE VALUES DO NOT APPLY TO CADMIUM PLATED FASTENERS  
 2. ALL TORQUE VALUES ARE STATIC TORQUE MEASURED PER STANDARD AUDIT METHODS TOLERANCE = +10%  
 \*3. ASSEMBLY USES HARDENED WASHER OR FASTENER IS PLACED AGAINST PLATED STEEL OR RAW ALUMINIUM  
 4. CLAMP LOAD LISTED FOR SHCS IS SAME AS GRADE 8 OR CLASS 10.9 AND DOES NOT REPRESENT FULL STRENGTH CAPABILITY OF SHCS. IF HIGHER LOAD IS REQUIRED, ADDITIONAL TESTING IS REQUIRED.

Torque Specs

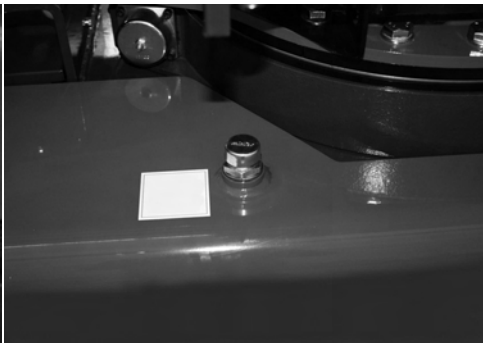
## 12.10. HYDRAULIC OIL LEVEL CHECK



*The check must be carried out with the machine and the stabilisers in the resting position on flat ground.*



**Fig. 164** Hydraulic oil level indicator



**Fig. 165** Hydraulic oil tank cap

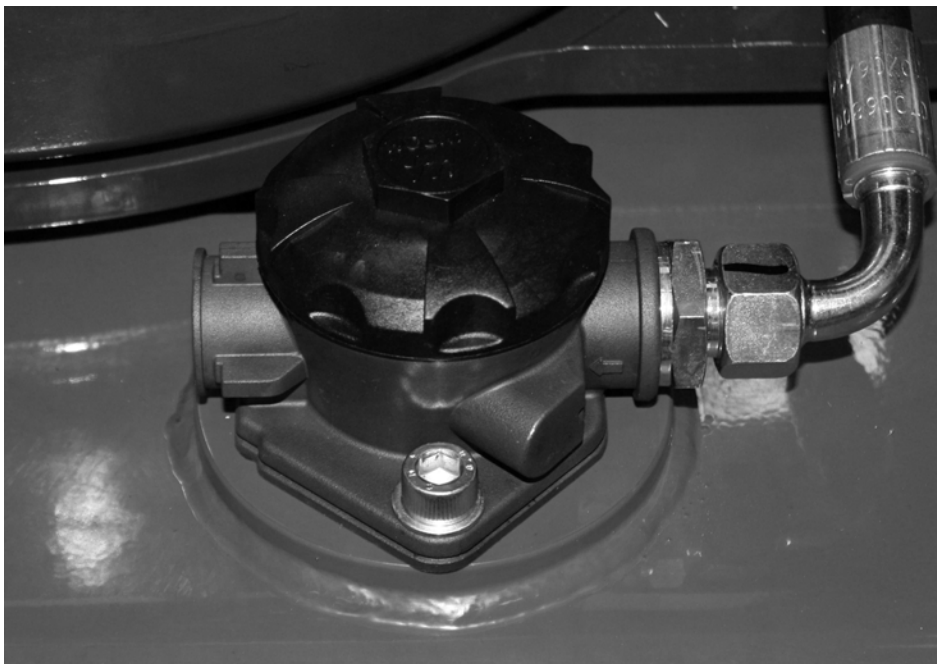
Check the oil level on indicator; the oil must be half way up the level indicator. If this is not the case, top up through the relative cap. For the characteristics of the hydraulic oil to be used see the relative paragraph "Table of recommended lubricants (p. 139)".

## 12.11. CHECKING FOR LEAKS IN THE HYDRAULIC SYSTEM

Visually check all hoses, connections and all other components in the hydraulic system, in order to identify any possible leaks. Leaks from hoses can normally be resolved by tightening the fittings. Leaks from gaskets (O rings, sealing rings etc.) cannot be eliminated by simply tightening, as gaskets usually leak because they are damaged or have become hard. The correct tightness can only be restored by replacing the gasket.

## 12.12. CHECKING THE CONDITION OF THE FILTER CARTRIDGE

The cartridge must be replaced on every oil change and according to the intervals specified in the maintenance table.



**Fig. 166** Hydraulic oil filter position

For the cartridge check follow the below instructions:

- 1 Unscrew the cap of the filter and remove the filter cartridge.
- 2 If it is very dirty, replace it with a new one having the same characteristics.
- 3 Tighten cap of the filter.




*It is very important to replace the cartridge for the first time after 50 operating hours, to eliminate hose and hydraulic component processing residues from the hydraulic system.*

### **12.13.CHECKING THAT ALL THE PLATES ARE PRESENT ON THE MACHINE AND INTACT**

Make sure that the prohibition, warning, danger and control plates positioned on the machine are all present and visible.

See the paragraph regarding decals "Safety warnings (p. 30)", to identify any missing or damaged plates.

## 12.14.CHECKING THE OPERATING PRESSURES IN THE HYDRAULIC SYSTEM

 A pressure gauge, with a minimum scale of 250 bars, must be used to carry out this check.



*Make sure that the machine is closed and in the resting position.*

*Make sure that no one is standing within the machine operating range.*

*All the specified checks must be carried out from the control position in the basket.*

- 1 Connect the pressure gauge to the pressure intake on the aluminium delivery manifold block. First connect fitting upper pressure intake.



**Fig. 167** Pressure check on the machine

- 2 Go to the control position and switch the machine on.

- 3 Close one of the two right stabilisers completely and maintain the movement activated. Read the pressure value. This value relates to the right track distributor. Switch the machine off.
- 4 Connect the pressure gauge to fitting lower pressure intake.
- 5 Go to the control position and switch the machine on.
- 6 Close one of the two left stabilisers completely and maintain the movement activated. Read the pressure value. This value relates to the left track distributor.
- 7 Stabilise the machine.
- 8 Set the second boom cylinder to the FOLDING mode. Keep the joystick in position. Read the pressure value. This value relates to the aerial part distributor.

## 12.15.CHECKING EXTENSION ROPES



*Respecting the times indicated in the Periodic maintenance table "Periodical maintenance intervals (p. 147)" it is important to check wear and replace any extension ropes, if necessary.*

The operations described in this paragraph must be carried out by qualified staff. It is recommended to contact an authorised centre to have the state of the pulleys and ropes by expert skilled staff. A detailed procedure is given below for the execution of the control of the state of the ropes and pulleys and for the check and any reset of the correct degree of rope tension.



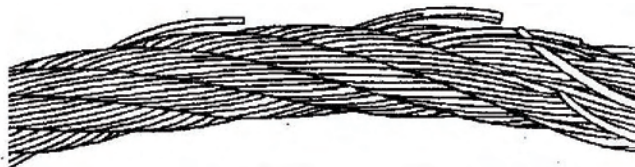
*Remember that ropes and pulleys must be replaced by an Authorised centre. The Constructor is not liable for damage/injury caused to objects/persons/animals in the case of incorrect assembly of the lifting systems by unqualified staff.*

### 12.15.1.Checking wear and deformation of ropes and pulleys



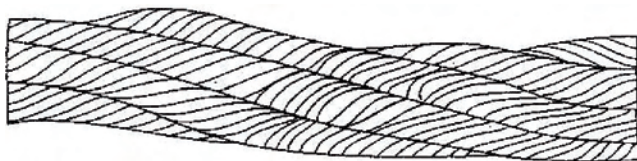
*If only one of the following situations is detected the ropes or pulleys must be replaced.*

- 1 Check that there are no broken threads on the surface of the rope, in the internal area or in correspondence with the cable socket.



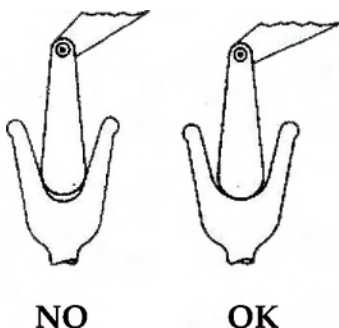
**Fig. 168** *Broken threads example*

- 2 Check that there are no signs of corrosion on the rope.
- 3 Check that there are no signs of kinking, crushing or deformations of any type on the rope.



**Fig. 169** *Kinking example*

- 4 Check the condition of the fixing pins of the outlet pulley and extensions return.
- 5 Check the wear of the pulley grooving using a profile comparator. As indicated in the figure it is necessary to check that the outline of the comparator corresponds with the base of the grooving.



**Fig. 170** *Pulley check example*

- 6 Check that there are no signs of ovalisation, wear or any other type of deformation on the pulleys.

### **12.15.2. Three-monthly inspection**

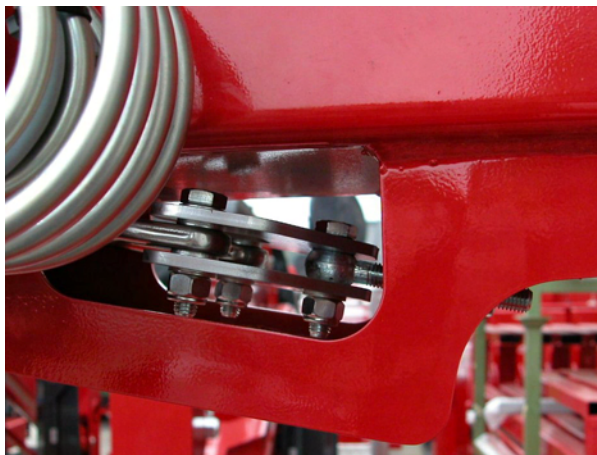
- Remove all protection sumps from the third arm and the two extensions. Use an electric torch to visually check the state of the ropes and the extension pulleys.
- Check the correct rope tension, trying to bend them manually. If they are pulled correctly they should not be able to move more than a few millimetres.
- Check that in the extension arms exit phase the return ropes are sufficiently in traction in a way not to allow relative contact with the third boom.
- Vice versa in the extension return phase, check that the outlet ropes are subject to a tension that allows them not to come into contact with the second extension or the cylinder.

- Use a dynamometric wrench to check the correct torque of all rope fixing nuts and the respective rocker arms; recommended torque **10 Nm**.

If the tension of the ropes should not be adequate the conditions for use must be restored by scrupulously following the Ropes Tension Adjustment procedure reported below.

### *12.15.3.Ropes Tension Adjustment Procedure*

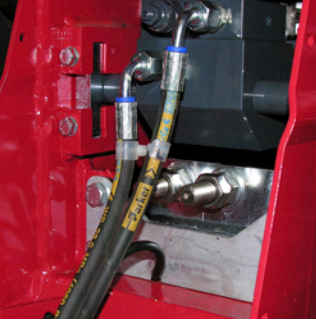
- 1 Stabilise the machine on the flat.
- 2 Remove the cover in the rear part of the third boom.
- 3 Loosen the register counter-nuts by a few turns, position them in a way to access the adjustment nuts in order to make the adjustment. (2 nuts with relative counter-nut for outlet ropes and one nut with relative counter-nut for return ropes rocker arm).
- 4 Completely retract both extendible arms and make them escape for about 30-40cm.
- 5 Tighten the nut for the traction of the fixing rocker arm of the return ropes to a torque of **10Nm**.



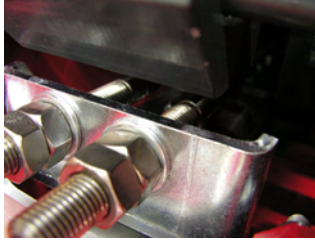
**Fig. 171** *Return fixing ropes*

- 6 Completely extend the extensions and retract them by about 30-40cm.
- 7 Tighten the bolts of the two output cables so that the threaded terminals come out of  $65\pm 3$  mm from the rocker arm. During adjustment keep the ropes blocked to prevent them turning with the nuts. Make use of the relevant seat for the wrench on the cable socket.

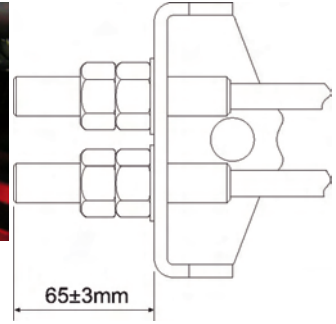




**Fig. 172** Exit ropes nuts fixing



**Fig. 173** Ropes terminal



**Fig. 174** Tension ropes regulation

- 8 Activate the movement of the extendible arms several times and check that the residual loads on the ropes are **10Nm**.
- 9 This procedure could require several attempts before it is completed correctly.
- 10 **The adjustment is correct when the ropes do not emit any noise during extension or return and the torque value prescribed is reached on all of the ropes.**
- 11 Once calibration has been concluded, tighten the counter nuts and re-mount the sump.



*Do not subject the ropes to torsion.*

#### 12.15.4. Five-yearly inspection

The replacement of the cables and pulleys is advisable every 5 years, even in shorter time according to the working hours.

Further inspections of the extension system are required in the following situations:

- Machine exposed to extreme environmental conditions (for example low temperatures, sea environments, etc.).
- Incorrect movement of the arms or noises caused by the movement of the extensions.
- Unused machine for long periods.
- Overloaded machine or subject to collisions.
- Machine subject to short circuit, the ropes could be damaged internally.

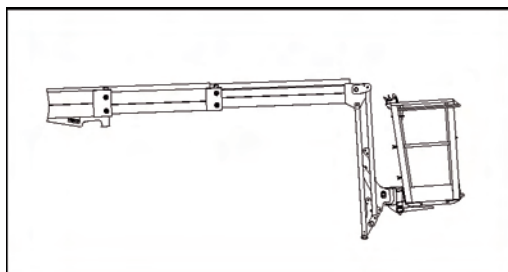
Remember that in all cases the Constructor envisions a mandatory check of the entire machine, including ropes and pulleys, every 1000 hours of use, which must be performed at a certified assistance centre.



*After having carried out any maintenance intervention, before allowing an operator to use the machine to ascend to height it is compulsory to carry out all machine movements from the ground in order to check the correct functioning of the hydraulic and electrical parts. Check the functioning of all safety devices and their correct*

*Signalling on the machine remote control. Moreover, after having carried out a series of movements, re-control the balance and the degree of tension of the ropes and the extension of the extensions. Only at this point is the machine ready for use.*

## 12.16. CHECKING WEAR OF THE TELESCOPIC ARM SLIDE BLOCKS



**Fig. 175** *Check wear*

- Visually check play of the extension boom.
- In case the play exceeds 3 mm it is necessary to operate on the plastic registers screwing them in order to lean to the arm in case of the upper ones, or bringing them to 1 mm circa in case of the lower ones. Check the support and the correct distance, slipping off and closing the arm completely.
- The slide blocks must be replaced at an authorised workshop.

## 12.17. BATTERY PETROL/DIESEL ENGINE: MAINTENANCE - REPLACEMENT - DISPOSAL



• The battery contains diluted sulphuric acid, which is highly explosive. Do not use naked flames or produce sparks near the battery (explosive gases). Proceed with care, shielding your eyes and face. In case of accidental contact with the sulphuric acid, rinse immediately with plenty of running water.



*Before working on the battery, ALWAYS disconnect the battery cut-out switch.*

In the case of AGM (Absorbed Glass Mat) the battery not require any maintenance.

In the case of lead acid battery maintenance is reduced and in most cases not necessary. However, if the electrolyte, with the machine on a level surface, is below the minimum allowed level (MIN.), it is possible to top up by removing the sealing caps and adding distilled water without exceeding the maximum level (MAX.).



*If the machine is going to remain unused for more than one month, it is advisable to insulate the battery.*

When the battery cannot accumulate electric energy any longer, replace it with a new one having the same characteristics. See the specifications table on the battery. Follow the steps below to replace:

- With the machine off and engine key in the OFF position disconnect the battery switch;
- Disconnect the battery terminals, always starting from the negative pole (-).
- Remove the battery and install the new one;
- Reconnect the cables, always starting from the positive pole (+).



*The batteries must be disposed of in compliance with the specific regulations in force.*

## 12.18.BATTERY PACK MAINTENANCE OPERATING SPECIFICATIONS

The battery pack must be used and handled with care to ensure safe operation and maximum machine performance. Any modifications made by unauthorised personnel invalidate the warranty and may cause damage to the machine and harm to people and things. Only qualified personnel are authorised to handle and access the battery pack. The battery pack is made up of just one module positioned at the rear of the machine. In case of problems, only authorized personnel are authorised to access the battery pack and replace it. Additional electronic devices may have a negative influence on the correct operation of the electronic components provided on the machine. For this reason it is absolutely forbidden to use any devices on the vehicle that do not comply with directive 72/245/EEC and its subsequent amendments (2005/49/EC, 2005/83/EC, 2006/28/EC). The constructor accepts no liability for any damage due to failure to comply with this warning.



### **NEVER OPEN THE BATTERY PACK**

*Opening and handling the battery pack is dangerous. Failure to observe this warning automatically voids the warranty.*

*The battery pack works at peak performance and in safe conditions with an ambient temperature between 0°C and 40°C. Using the battery pack out of this temperature range may be dangerous.*

*Before working on the battery pack in any way read the paragraph relating to the technical data of it "Technical data (p. 19)".*

The batteries and all electrical / electronic components that compose the battery pack does not require maintenance. The only action required by the system is re-charging the batteries according to the frequency of use of the machine and instruction written in this manual. For charging the battery to see "Charging Lithium batteries (p. 133)".

Avoid leaving the machine in sunny and badly ventilated places for long periods. The battery pack is connected to the motor control via a fuse.

The fuse may be replaced only by qualified personnel. Always keep the battery charged. Recharge the battery pack whenever considered necessary, even if the battery has not completely run down. To check the battery level use the special indicator provided. The battery level depends on many factors, for this reason, to avoid incorrect reading of the indicator, always keep the batteries charged. If the machine is not used for extended periods, recharge at least every 3 months.

### *12.18.1.Handling in dangerous conditions*

The battery cells must be handled correctly in order to ensure proper and safe use. However, if mistakes are made in handling the cells, causing explosion or venting, the user has to be equipped so as to be able to face this emergency. The aim of this section is to adequately train the user on safe handling of the cells that have been subjected to extreme conditions like:

- 1 Hot cells
- 2 Cells that have released substances or vented
- 3 Exploded cells
- 4 Fire enveloping the lithium batteries

#### *12.18.1.1.Personal protective equipment*

When recharging the battery pack and during any other maintenance operation on the battery pack, it is necessary to use at least the Personal Protective Equipment (PPE) listed below.



Protective glasses in accordance with EN 166, for protection against sprays of hazardous materials.



Hand protection gloves in accordance with EN 60903, for protection and insulation during work on live parts.



Shoes with antistatic coating able to insulate the worker during work on the electrical parts of the system.

#### *12.18.1.2.Procedure for handling hot cells*

As soon as it has been established that the temperature of a cell has risen considerably, the first action is the evacuation of personnel from the affected area. The area has to be isolated and nobody can enter if not strictly necessary. If possible, before leaving the area, the person who first identified the problem has to check if there is an external short-circuit and resolve it as soon as possible. After the

short-circuit has been resolved, the cell will start to cool down. However, the area has to remain isolated until the cell reaches ambient temperature and is removed from the area. The temperature of the cell has to be checked periodically using a remote sensor such as an infra-red sensor. If the cell remains hot the following actions must be assessed.

MINIMUM EQUIPMENT REQUIRED:

- Infra-red temperature probe
- Safety glasses
- Hard hat with impact resistant face visor
- Non-conductive pliers
- Hand, arm and body protection

PROCEDURE:

- Evacuate the area as soon as abnormal cell temperature has been established.
- Periodically check the temperature of the cell using a remote sensor for the first two hours or until one of the following cases occur:
  - The cell starts to cool down
  - The cell vents
  - The cell explodes
- If the cell starts cooling, check the temperature every hour until ambient temperature has been reached.
- If a temperature sensor is not available, do not handle the cell for a minimum of 24 hours.
- Remove the cell from the work area when ambient temperature has been reached and return to normal operations.
- Dispose of the cell in accordance with existing legislation (in the country in question) on hazardous goods.
- The procedures in cases of venting or explosion are examined in the following paragraphs.

*12.18.1.3.Procedure for handling vented cells*

In normal conditions a cell does not show leaks or venting, however a cell may vent or release substances if the critical temperature is reached or if the protective glass-metal seal breaks due to severe mechanical conditions. The severity of the leak consequent to venting ranges from slight leak around the seal to a violent leak of substances through the vent. In some cases, if the cell is not plugged, it

may behave as a projectile. The electrolyte inside the cell may cause very serious irritation to the respiratory tract, eyes and skin. In addition, venting may cause the emission of highly corrosive vapours in the work environment. In this case, all protective equipment suited to limit exposure to toxic fumes must be available.

#### MINIMUM EQUIPMENT REQUIRED:

- Class D fire extinguisher
- Eye protection or face shield
- Respirator with filter for hydrochloric acid and sulphur dioxide
- Neoprene gloves
- Acid-resistant lab coats
- Baking soda, calcium oxide or acid absorbent in kit form
- Vermiculite
- Plastic bags

#### PROCEDURE:

In the event of electrolyte release from the cells, proceed as follows:

- Evacuate the people exposed to fumes from the area.
- Air the environment until the complete removal of the cell and until the characteristic pungent odour has disappeared.
- If the cell is too hot, allow it to cool to ambient temperature before handling it.
- Wear safety equipment: coat, gloves, mask and filters, and move the cell to a well-ventilated area.
- Place every cell in a sealable plastic bag and remove the excess air, then seal the bag.
- Place a cup of vermiculite in a second bag, place the first bag in the second and seal it.
- Place everything in a third bag with some soda and seal the bag.
- Absorb and collect the leaked electrolyte with absorbent material or soda.
- Place the absorbent material in a bag and seal it.
- Clean the area with plenty of water.
- Dispose of the hazardous material in accordance with the local legislation in force.

#### FIRST AID IN THE EVENT OF CONTACT WITH THE ELECTROLYTE:



**EYES**

Immediately wash the eyes in abundant running water for at least 15 minutes, keeping the eyelids open and flushing the eye and back of the eyelid. Immediately seek medical help.

**SKIN**

Wash in cold water under a shower, remove contaminated garments. Continue washing for at least 15 minutes. Seek medical help where necessary.

**RESPIRATORY TRACT**

Move the casualty outdoors into the open air. If the casualty has difficulty breathing, have oxygen administered by trained personnel. If breathing stops, apply mouth-to-mouth resuscitation and immediately seek emergency medical help.

*12.18.1.4.Procedure for exploded cells*

The explosion of lithium batteries is not likely, it is a rare event that only occurs when an abnormal condition causes the temperature to rise and reach a critical point. However, in the event of lithium battery explosion the environment will quickly be filled with dense white smoke which will cause serious irritation to the respiratory tract, eyes and skin. Precautions must be taken to limit exposure to these fumes.

**MINIMUM EQUIPMENT REQUIRED:**

- Class D fire extinguisher
- Class ABC extinguisher for any secondary fires
- Eye protection or face shield
- Respirator with filter for hydrochloric acid and sulphur dioxide
- Neoprene gloves
- Acid-resistant lab coats
- Baking soda, calcium oxide or acid absorbent in kit form
- Vermiculite
- Plastic bags

**PROCEDURE:**

In the event of cell explosion, proceed as follows:

- Evacuate personnel from the areas contaminated by smoke.
- Ventilate the rooms until the cell has been removed from the area and until the characteristic pungent odour has disappeared.

- Even if this is quite unlikely, there may be fires as a consequence of the explosion. The ways these emergencies are faced are described in the following paragraph.
- The exploded cell may be hot. Allow it to cool down to ambient temperature before handling it (see Procedure for handling hot cells).
- Wear safety equipment: coat, gloves, mask and filters.
- In case of explosion the area around the cell will be covered by a black carbonaceous material which contains metallic parts of the cell. Cover the carbonaceous residues with a 50/50 mixture of soda and vermiculite or other absorbent material. Avoid contact between the metallic residues and charged cells, as this condition may cause a short-circuit.
- Place the contaminated material in a sealable plastic bag and remove the excess air. Seal the bag.
- Place a cup of vermiculite in a second bag, place the first bag in the second and seal it.
- Clean the area with plenty of water and keep cleaning with water and soap.
- Dispose of the hazardous material in accordance with the local legislation in force.

FOR THE FIRST AID IN THE EVENT OF CONTACT WITH THE ELECTROLYTE SEE THE PREVIOUS PARAGRAPH "PROCEDURE FOR HANDLING VENTED CELLS (P. 177)".

#### *12.18.1.5.Lithium battery fire*

All metals may burn in certain conditions, which depend on certain factors such as: physical state, presence of oxidising atmospheres and severity of the source of ignition. Alkali metals such as lithium may burn in normal atmospheres. In addition, lithium reacts explosively with water to form hydrogen and the presence of small quantities of water may set fire to the material and the hydrogen gas that is released. Once metal fires start they are very hard to extinguish with ordinary equipment. This is partly due to the strong heat produced by the burning metal, whose temperature may reach 1000°C. In addition, lithium may react with certain materials commonly used in fire extinguishers, like water and CO<sub>2</sub>. Special extinguishers are required, designed for controlling and extinguishing lithium fires. In particular, graphite-based extinguishers (Lith-x) are used. Usually these extinguishers work by forming a crust or a layer of material on the surface of the burning metal. Lith-x, which is a common graphite-based agent, may be used with an extinguisher or spread over the fire. In the event of lithium fire, the room may fill with a dense white smoke, mostly formed by lithium oxide and other metal ox-

des. This condition may cause serious damage to the respiratory tract, skin and eyes. All precautions needed to limit exposure to these fumes must be adopted. It should be noted that this procedure is applicable only to fires on individual cells. Larger fires have to be managed only by professionally trained personnel. Finally, it should be noted that in the presence of combustible materials other than lithium it is advisable to use different types of extinguishers in conjunction to better ensure the extinguishing action of each on the appropriate material, however do not use water or CO<sub>2</sub> extinguishers directly on lithium fires.

#### MINIMUM EQUIPMENT REQUIRED:

- Class D fire extinguisher
- Class ABC extinguisher for any secondary fires
- Breathing apparatus
- Fireproof clothing
- Fireproof gloves
- Mask or protective glasses
- Non-conductive pliers
- Dustpan, mineral oil

#### PROCEDURE:

- In the event of fire on one cell, a team of experienced fire-fighting personnel has to be contacted. The personnel must be properly trained to fight lithium battery fires.
  - Evacuate personnel from all areas and sound the fire alarm.
  - The fire-fighting personnel go to the area where the fire is located and gather all the information regarding the situation and the person who gave the alarm.
  - Quarantine the area. Air the rooms until the burning material has been removed from the area and the characteristic pungent odour has disappeared.
  - Two members of the team enter the area with appropriate safety equipment.
- Lithium melts at 180°C. It becomes highly reactive and when it catches fire it may eject molten lithium particles. For this reason the surrounding cells may overheat and cause a violent explosion. The fire-fighting personnel must pay attention to any dangerous materials located near the fire. Completely cover the fire with extinguishing material. Never leave the fire unattended as it may develop again.
- If necessary, extinguish the secondary fires with suitable extinguishers.
  - After all the material has burned and cooled down, carefully mix the residual material to prevent resumption of the fire.

- Put the material in a metal drum, cover the surface with plenty of extinguishing material. The residual material may contain unreacted lithium, therefore limit exposure to rain by covering, for example, with mineral oil.
- Wear safety equipment: coat, gloves, mask and filters.
- The area around the cell will be covered by a black carbonaceous deposit which contains metallic parts of the cell. Cover the carbonaceous residue with a 50/50 mixture of soda and vermiculite or other absorbent material. Avoid contact between the metallic residue and charged cells as this condition may cause a short-circuit.
- Place the contaminated material in a sealable plastic bag and remove the excess air. Seal the bag.
- Place a cup of vermiculite in a second bag, place the first bag in the second and seal it.
- Clean the area with plenty of water and keep cleaning with water and soap.
- Dispose of hazardous material in accordance with the local legislation in force.

FOR THE FIRST AID IN THE EVENT OF CONTACT WITH THE ELECTROLYTE SEE THE PREVIOUS PARAGRAPH "PROCEDURE FOR HANDLING VENTED CELLS (P. 177)".

### 12.19.SERVICING THE ENGINE THERMIC VERSION

Refer to the engine manual provided herewith.

### 12.20.START-UP OF THE MACHINE AFTER MAINTENANCE



*After any maintenance operation, before using the machine to work at a height it is compulsory to perform all the movements controlling them from the ground, in order to make sure that the hydraulic and electrical system are in good working order. Make sure that all the safety devices are functioning and are correctly shown on the remote control. Furthermore, after performing a series of movements, check again the balance and the degree of tension of the ropes, as well as the centring of the extension arms.*

*Only then will the machine be ready for use.*

## 13.SAFETY STANDARDS FOR TRANSPORT



*Always make sure that the vehicle used to transport the platform has suitable capacity and that no part of the MEWP protrudes from the size limits prescribed by the road traffic regulations.*

**During transport, cover the remote control with the special protection casing provided, or disconnect it and store it in a safe place.**

### 13.1.REMOVING THE BASKET

Is permitted remove the basket only to allow passage through the openings of a width less than the basket but more than the machine.



*If the machine is without basket, only the tracks can be moved, keeping at a minimum distance of 1 metre from the machine.*

To remove the basket, proceed as follows:

- remove the remote control from the support;
- loosen the aluminium covers on the basket fixing pins;



**Fig. 176** *Cap lock pin*

- withdraw the basket from above;

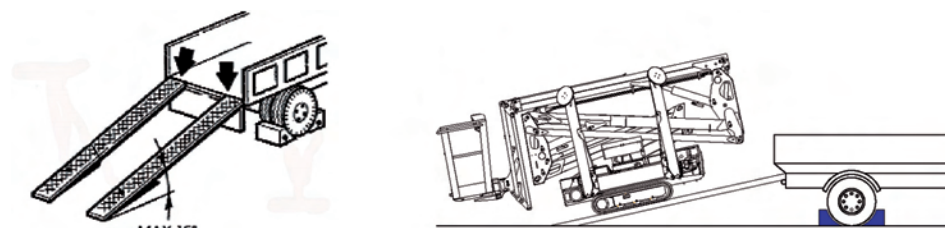
Reassemble the basket as follows:

- fit the basket into the fixing pins on the basket support, making sure that it moves downwards as parallel to the basket support as possible.



- Tighten the two aluminium covers.

### 13.2.LOADING AND UNLOADING THE MACHINE ON TRANSPORT VEHICLES USING RAMPS



**Fig. 177** Loading on the ramps

The platform offers high manoeuvrability and stability even in travelling configuration. Despite this, the user must work with care even when carrying out the simplest operations.

During the loading and unloading from the truck or trailer through the use of ramps follow the following guidelines:

- Make sure the truck or trailer is rated accordingly for the transport of PLE. Refer to the weight indicated in the technical data section of this manual "Technical data (p. 19)".
- Park the lorry or trailer on a flat surface.
- Select ramps of adequate length to ensure a maximum angle of inclination respect to the ground less than or equal to  $15^{\circ}$ . As a general rule, if the ramps and the truck / trailer rely on free surface without slope variations, this requirement is met if the ratio between the length of the ramps and the height of the arrival of the ground is greater than or equal to 3.7.
- Make sure that the ramps have a sufficient capacity to support the machine. Refer to the weight indicated in the technical data section of this manual "Technical data (p. 19)".
- Make sure that the ramps are free from debris or slippery material.
- The truck or the trailer must be stopped with the wheels locked, the parking brake engaged, the engine shut off and the dump level.
- Ramps shall be securely supported and fixed to the structure of the plan of arrival. Check the validity of the engagement to the truck / trailer before using the ramps.
- The highest point of the ramp must be coplanar with the arrival. No steps shall be presented to the machine in the transition from the ramp the floor arrival or departure.

- Widen the carriage platform before tackling the ramps.
- Adjust the distance between the ramps in function of the roadway of the two tracks.
- Always empty the basket before tackling the ramps.



- **Climb the ramps proceeding with the machine oriented with the basket towards the rear.**
  - **Close to the variation of inclination between ramp and floor truck / trailer, proceed with great caution to avoid jolts.**
  - **Proceed very slowly on the ramps adjusting the speed with the proportional levers. In the elevation changes proceed at minimum speed possible. MAKE SURE THAT THE ENGINE IS AT IDLE SPEED (turtle speed select). Maintain a constant speed. Avoid abrupt starts and braking. Make sure before proceeding on the ramps that each track is FULLY content on the surface of each ramp. In tackling the ramps proceed with PERFECTLY straight trajectory making sure at ALL times that each track is FULLY contained on the surface of each ramp.**
  - Place the machine so that no part of it comes out of the shape of the vehicle.
- For the descent follow the requirements above.



*During the translation phases and stages of change of slope careful not to damage the safety devices placed under the basket and near the end of the first extension. In the case of the change of slope would be too high change the slope of ramps or use ramps longer.*



### 13.3.LIFTING THE MACHINE

To lift the machine, first of all a lifting device is required that has a suitable capacity depending on the distance and the height to which the MEWP is to be lifted.



- For lifting operations necessary for maintenance or loading onto transport vehicles, only use machinery (e.g. forklifts, crane, overhead cranes etc.) and load pick-up devices (e.g. ropes, chains, hooks) with suitable capacity and in perfect working order; for the weight of the machine, consult the paragraph relative to the technical features of the MEWP "Technical data (p. 19)". The photograph below shows how and where the MEWP must be attached.
- When lifting the machine, it must be in transport configuration (extensible structure completely closed and aligned, stabilisers completely lifted and under-carriage extended). Otherwise, the machine would be unbalanced and lifting dangerous.
- Never lift the machine with the operator on board.
- During lifting, make sure that no people are in the area affected by the operations and do not move the suspended machine over persons.



Never lift the machine if it is not secured as shown herein; if, for example, it were lifted by attaching it to the arm, using devices for anchorage to the ground (above all not designed to support the weight of the MEWP) or simply passing a strap around any element of the arm, the turntable and other machine parts would be loaded with forces they are not designed for. There is a high risk of damaging the machine.

#### *13.3.1. Lifting the machine using a forklift*

The machine is equipped with two tubular designed to lift the machine using a forklift of suitable capacity.



**Fig. 178** Forklift lifting points

It is absolutely forbidden to lift the machine if it is not completely closed and aligned in transport position with the 4 stabilizers completely closed and lifted from ground. Before proceeding verify the weight of the machine in the technical data of this manual and make sure that the forklift is suitable for this weight. Verify also the dimensions of the forks and make sure that the positioning of the load is in compliance with the requirements of the forklift. Proceed approaching carefully to the machine paying attention not to collide with parts of it and cause damages to the structure. During the operations of lifting and transport follow the requirements and dispositions prescribed for the use of the lifting device and/or by the security officer of the working environment in which the operation is performed. This operation must be performed by appropriate personnel possessing the regulatory requirements to the use of the lifting device chosen.



*The manufacturer of the Platform is not responsible in any way for damages caused to the machine, lifting device or persons and/or objects due to improper execution of this operation.*

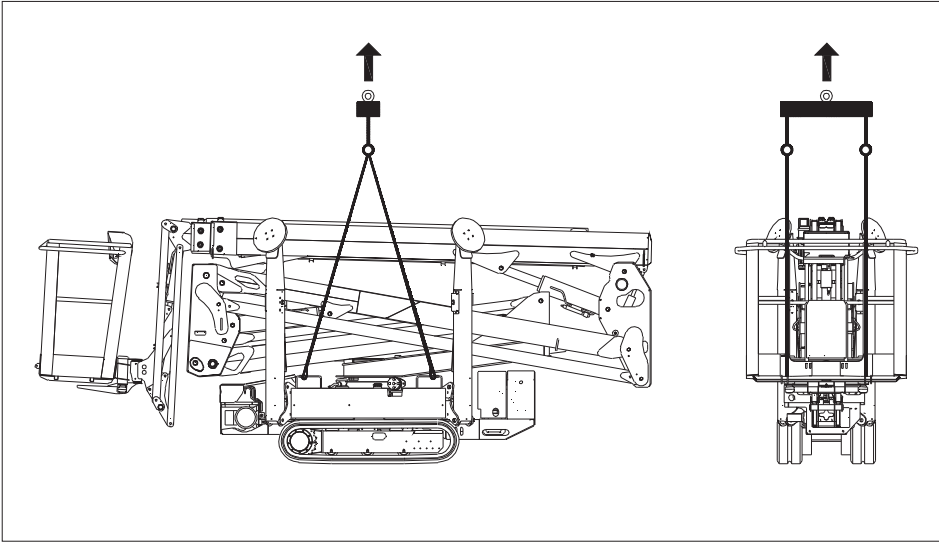
### 13.3.2. *Lifting the machine using ropes or chains*

The machine is equipped with 4 eyelets, positioned on the base, allowing to lift the machine through 4 ropes or chains of suitable length and capacity.



**Fig. 179** *Ropes or chains lifting points*

To properly lift the platform it is necessary to use a sling bar of adequate size and features, with a distance between hooks from 550 to 730 mm. The minimum capacity required for each rope, chain or sling used must be sufficient to ensure the support of the whole structure to be lifted and their length must ensure that the sling bar is positioned higher than the machine and that it does not touch the platform during the lifting phases. The following pictures are the guidelines for machine lifting.



**Fig. 180** *Ropes or chains lifting diagram*

The lifting devices must be in good working order and used according to the specifications supplied by the manufacturer. As the weight of the platform is not distributed equally over the four stabilisers, the minimum required capacity for the four ropes, chains or slings used must not be less than 2000 kg and they must be minimum 3 m long and all identical. The slings cannot be more than 60 mm wide, the chains not more than 25 mm, and the rope diameter cannot exceed 25 mm.



*The manufacturer of the Platform is not responsible in any way for damages caused to the machine, lifting device or persons and/or objects due to improper execution of this operation.*

*Using ropes, chains or slings shorter than 3 m could cause permanent damages to parts of the structure of the machine.*



*It is absolutely forbidden not to fasten to all four the points, the machine could result unbalanced. Furthermore it is compulsory to use four different ropes, chains or slings; in this way a breaking or a wrong anchorage of one of the connection devices would not imply dangerous movements of the load.*

### 13.4. TRANSPORTING THE MACHINE

Once on the trailer the machine must be fixed using tie rods as shown in the photo below. Make sure that the dimensions of the machine and the trailer are compatible with road traffic regulations.



**Fig. 181** *Fixing hook 1*



**Fig. 182** *Fixing hook 2*



The fixing system connection points are identified by the sticker.



*Do not make connections in points other than those identified by the sticker. This could cause permanent damage to the structure with risk of collapse.*

## 14.SERVICE MENU ON THE REMOTE CONTROL

A SERVICE button "Push buttons (p. 61)" is available on the remote control and is used to display the status of the machine parameters and as assisting device for the safety checks to be carried out on the machine, as specified in this manual. Pressing button 6 accesses a numerical menu, controlled by the number buttons on the remote control. The meaning of these menus is explained in this manual. If after reading the manual you still have some doubts, contact the after sales service.

### 1 INPUT

LANGUAGE

ERRORS

RAMPS

CURRENTS

WORKING HOURS

SETTING

JOYSTICK

ESC



*The 4-5-7 menu items are not normally used except for setting operations and diagnosis by qualified personnel.*

### 14.1.INPUT MENU

This displays the signals received by the board from the various sensors fitted on the machine and from the controls on the remote control. Each screen shows the status of the input and options to scroll the menu.

### 14.2.LANGUAGE MENU

Allows you to select menu language among those available.

### 14.3.ERRORS MENU

Indicates correspondence between the double sensors, either (OK) or (FAULT). If the OK symbol is shown next to the sensor, this means that both elements on the same sensor are sending congruent information. If the FAULT symbol is shown next to the sensor, this means that the elements on the same sensor are sending contradictory information.

The last page of the error menu describes the error code relating to the battery charger system, inverter and battery pack. Errors are indicated by the "spanner" icon "Fig. 45 Lithium error(p. 58)" in position 7 on the remote control display.

If the machine has problems in the functioning and the icon "spanner" on the display will not reset turning off and restarting the machine, contact the after sales department.

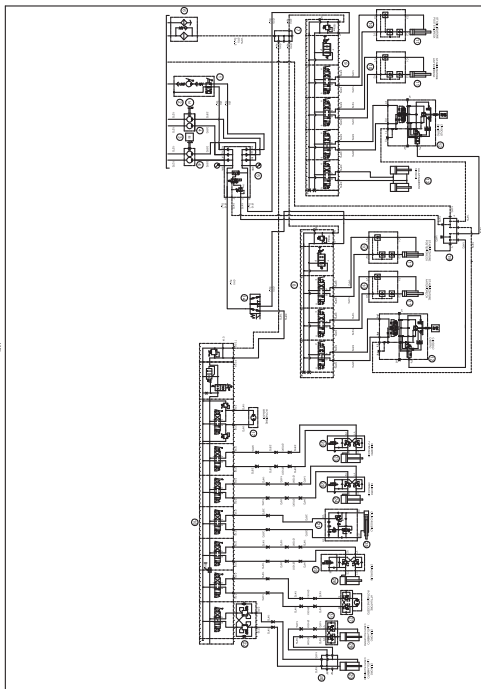
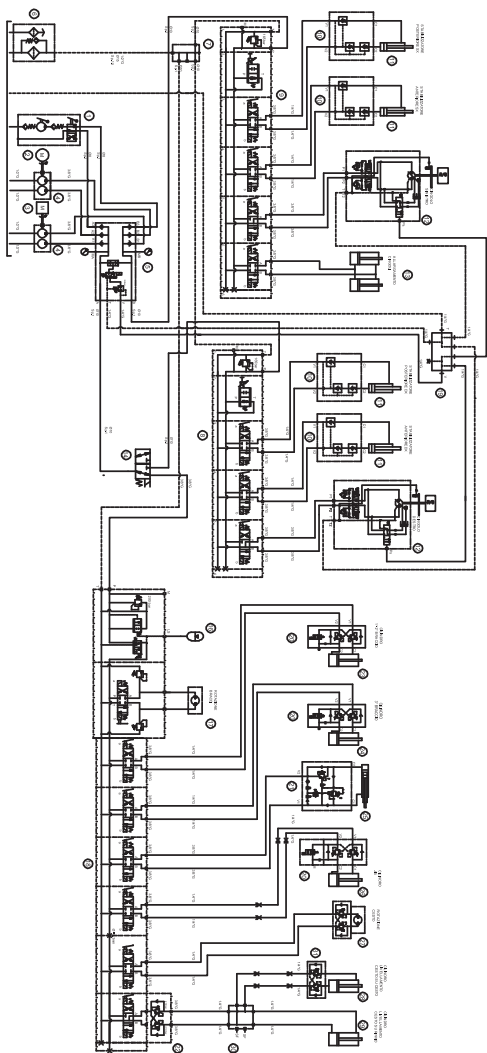
#### **14.4.WORKING HOURS MENU**

Indicates the number of machine operating hours.

#### **14.5.JOYSTICK MENU**

Displays the signal that each individual joystick sends to the main board.

15.HYDRAULIC SYSTEM



Riferimento	Descrizione
1	Hand pump



<b>Riferimento</b>	<b>Descrizione</b>
2	Electric motor
3	Honda iGX440 petrol engine / Perkins diesel engine
4	Double gear pump
5	Pump outlet manifold block
6	Discharge filter
7	Discharge manifold
8	Distributor
9	Distributor
10	Stabiliser stop valve
11	Stabilizer cylinder
12	Motorgear
13	Track gauge extension cylinder
14	Directional solenoid valve
16	Accumulator
17	Rotation motor
18	Distributor
19	Manifold
20	Balancing valve double
21	Extension regenerative balancing valve
22	Balancing valve double
23	1-2° boom cylinder
24	3° boom cylinder
25	Extension cylinder
26	JIB cylinder
27	Rotary actuator for basket rotation
28	Basket levelling cylinder on the basket

---

<b>Riferimento</b>	<b>Descrizione</b>
29	Basket levelling cylinder on the transmission
30	Deflection block for closed loop
31	Levelling balancing valve double

## 16.WIRING DIAGRAM



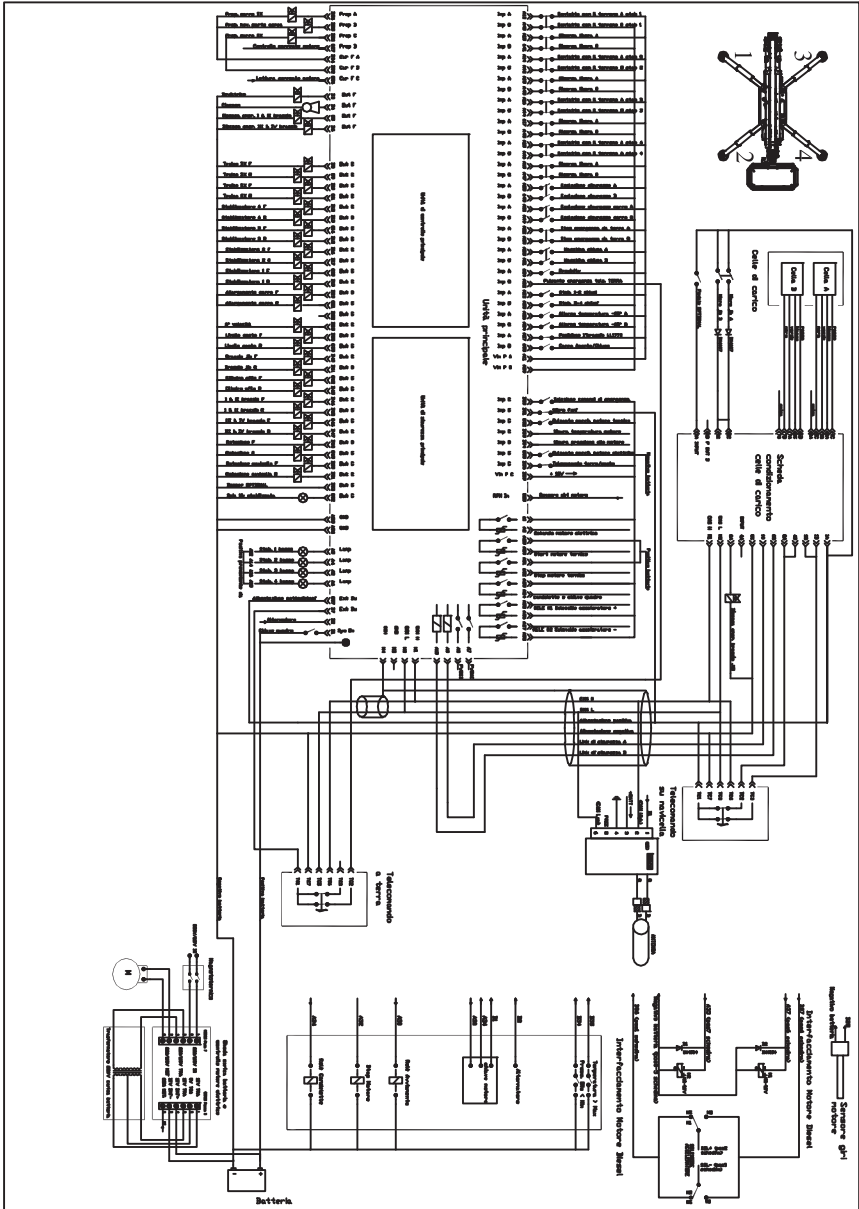


Fig. 184 Diesel

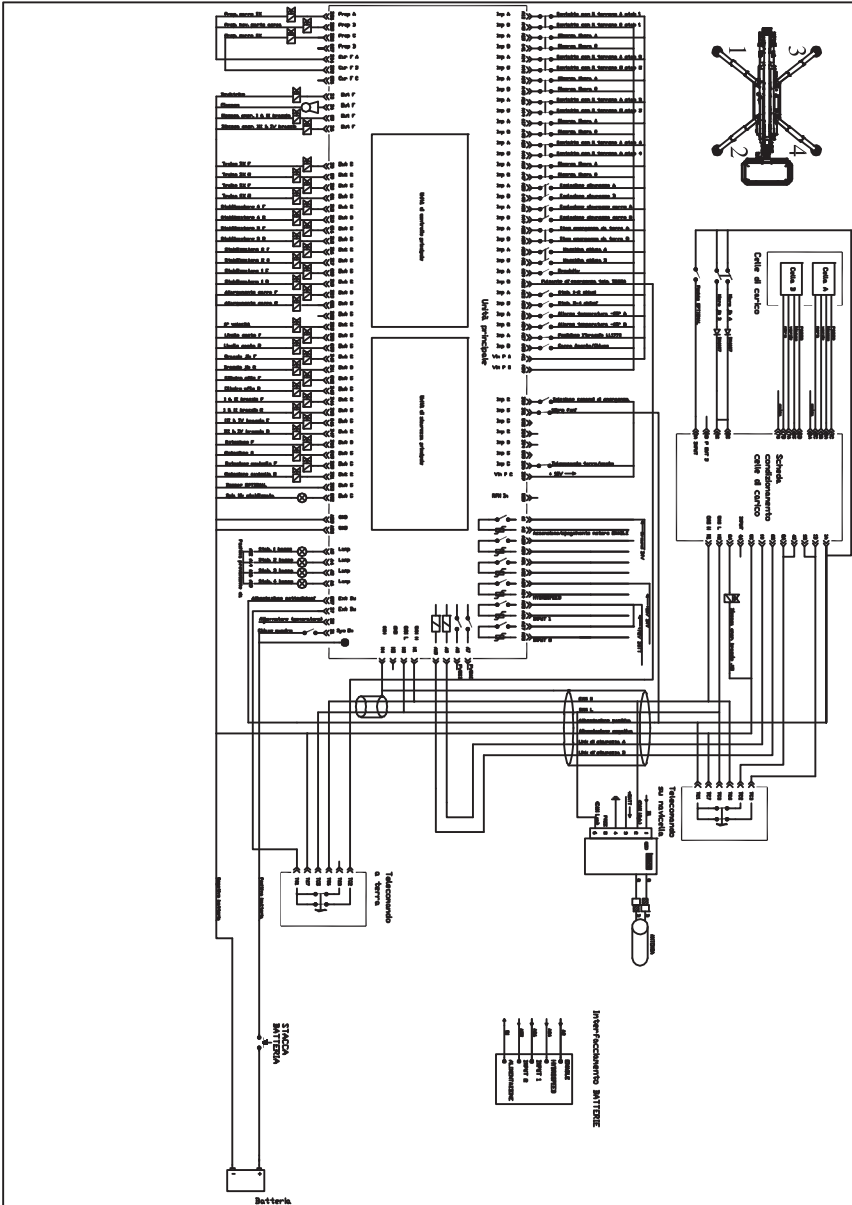


Fig. 185 Lithium



## TRANSFER OF OWNERSHIP

**To Product Owner:**

If you now own but ARE NOT the original purchaser of the product covered by this manual, we would like to know who you are. For the purpose of receiving safety-related bulletins, it is very important to keep JLG Industries, Inc. updated with the current ownership of all JLG products. JLG maintains owner information for each JLG product and uses this information in cases where owner notification is necessary.

Please use this form to provide JLG with updated information with regard to the current ownership of JLG products. Please return completed form to the JLG Product Safety & Reliability Department via facsimile or mail to address as specified below.

Thank You,  
 Product Safety & Reliability Department  
*JLG Industries, Inc.*  
 13224 Fountainhead Plaza  
 Hagerstown, MD 21742  
 USA  
 Telephone: +1-717-485-6591  
 Fax: +1-301-745-3713

**NOTE:** Leased or rented units should not be included on this form.

Mfg. Model: \_\_\_\_\_

Serial Number: \_\_\_\_\_

Previous Owner: \_\_\_\_\_

Address: \_\_\_\_\_  
 \_\_\_\_\_

Country: \_\_\_\_\_ Telephone: ( \_\_\_\_\_ ) \_\_\_\_\_

Date of Transfer: \_\_\_\_\_

Current Owner: \_\_\_\_\_

Address: \_\_\_\_\_  
 \_\_\_\_\_

Country: \_\_\_\_\_ Telephone: ( \_\_\_\_\_ ) \_\_\_\_\_

Who in your organization should we notify?

Name: \_\_\_\_\_

Title: \_\_\_\_\_

## Worldwide locations



An Oshkosh Corporation Company

Corporate Office  
JLG Industries, Inc.  
1 JLG Drive  
McCConnellsburg PA. 17233-9533  
USA

(717) 485-5161

(717) 485-6417

---

**JLG Worldwide Locations**


---

JLG Industries (Australia)  
P.O. Box 5119  
11 Bolwarra Road  
Port Macquarie  
N.S.W. 2444  
Australia

+61 2 65 811111

+61 2 65 810122

JLG Latino Americana Ltda.  
Rua Eng. Carlos Stevenson,  
80-Suite 71  
13092-310 Campinas-SP  
Brazil

+55 19 3295 0407

+55 19 3295 1025

JLG Industries (UK) Ltd  
Bentley House  
Bentley Avenue  
Middleton  
Greater Manchester  
M24 2GP - England

+44 (0)161 654 1000

+44 (0)161 654 1001

JLG Deutschland GmbH  
Max-Planck-Str. 21  
D - 27721 Ritterhude - Ihlpohl  
Germany

+49 (0)421 69 350 20

+49 (0)421 69 350 45

JLG Equipment Services Ltd.  
Rm 1107 Landmark North  
39 Lung Sum Avenue  
Sheung Shui N. T.  
Hong Kong

(852) 2639 5783

(852) 2639 5797

JLG Industries (Italia) s.r.l.  
Via Po. 22  
20010 Pregnana Milanese - MI  
Italy

+39 029 359 5210

+39 029 359 5845

JLG Polska  
Ul. Krolewska  
00-060 Warszawa  
Poland

+48 (0)914 320 245

+48 (0)914 358 200

Plataformas Elevadoras  
JLG Iberica, S.L.  
Trapadella, 2  
P.I. Castellbisbal Sur  
08755 Castellbisbal, Barcelona  
Spain

+34 93 772 4700

+34 93 771 1762

JLG France SAS  
Z.I. de Baulieu  
47400 Fauillet  
France

+33 (0)5 53 88 31 70

+33 (0)5 53 88 31 79

JLG Sverige AB  
Enkopingsvagen 150  
Box 704  
SE - 176 27 Jarfalla  
Sweden

+46 (0)850 659 500

+46 (0)850 659 534

Oshkosh-JLG Singapore Technology  
Equipment Pte Ltd  
29 Tuas Ave 4,  
Jurong Industrial Estate  
Singapore, 639379

+65-6591 9030







**An Oshkosh Corporation Company**

**Corporate Office**

JLG Industries, Inc.  
1 JLG Drive  
McConnellsburg PA. 17233-9533  
USA

Tel. +39 0442 539100

Fax +39 0442 539075

[www.jlg.com](http://www.jlg.com)