

TECHNICAL DATA SHEET

# **MRT 2150 2550 PRIVILEGE +**

**Manitou Telescopic**



 **MANITOU**  
HANDLING YOUR WORLD

# MRT 2150 2550 PRIVILEGE +



	MRT 2150 Privilege +	MRT 2550 Privilege +
<b>Lifting</b>		
Max. capacity with forks at 500 mm LC	4999 kg	
Max. lifting height	20.90 m	24.70 m
Max. outreach	17.90 m	21.40 m
<b>Tyres</b>	445 / 65 R22.5	
<b>Stabilizers</b>	duplex telescopic simultaneously and individually controlled	
<b>Full continuous rotation</b>	turret mounted on a double slew ring with internal gearing / slewing system with negative brake	
<b>Frame levelling / oscillating axle</b>	on front axles +/- 8° oscillating rear axle with automatic hydraulic lock out on rotation (> +/- 7.5°) and boom height (> 55°)	
<b>Braking</b>		
Service brake	oil bath multiple disc brakes hydraulically assisted on both axles	
Parking brake	automatic negative parking brake	
<b>Engine</b>	MERCEDES - STAGE 4 - FINAL TIER 4	
Type	OM 934 E4-5	
Displacement	4 cylinders - 5.13 liters	
Power	156 HP/115 kW	
Max torque	675 Nm - from 1200 to 1500 rpm	
Gradeability	40%	
Batteries	24 V: 2x 12V - 120 Ah - 850 A	
<b>Transmission</b>	hydrostatic	
Drive wheels	4 wheel drive	
Steering mode	4 wheel steer - 3 steering modes	
Max. travel speed <small>(may vary according to applicable regulations)</small>	36 kph	
<b>Controls</b>	2 multi-function joysticks	
<b>Hydraulics</b>		
Hydraulic pump	115 l/min – 275 bar gear type	
<b>Capacities</b>		
Hydraulic oil	225 l	
Fuel	305 l	
Urea (AdBlue type *)	57 l	
<b>Unladen weight (with forks)</b>	17930 kg	18900 kg
<b>Dimensions</b>		
Overall width	2.49 m	
Overall width <small>(stabilizers extended)</small>	5.55 m	
Overall height	3.05 m	
Overall length to carriage	6.87 m	7.84 m
Turning radius <small>(over tyres)</small>	4.88 m	
Ground clearance	0.35 m	
Standard forks <small>(length x width x thickness)</small>	1200 x 150 x 50 mm	
<b>Safety</b>	load state monitoring system (crane norm) attachement recognition system (E-Reco) cab compliant with ROPS / FOPS level II standard	
<b>Noise and vibration</b>		
Noise at driving position (LpA)	79.7 dB	
Environmental noise (LwA)	104 dB	
Vibration to whole hand/arm	<2.50 m/s <sup>2</sup>	

# MRT 2150 2550 PRIVILEGE+

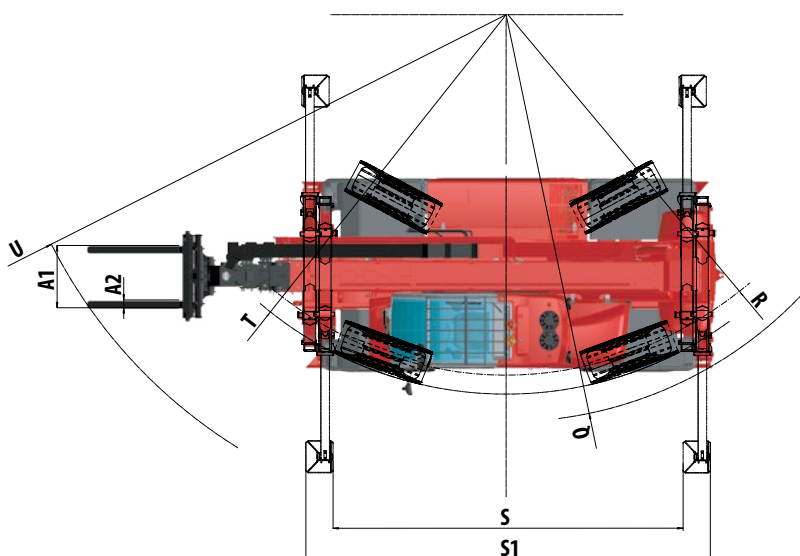
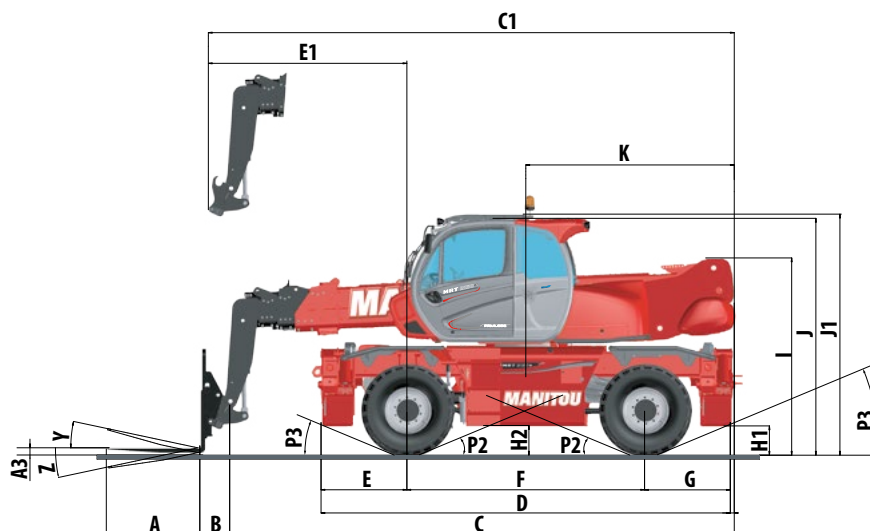

mm	MRT 2150/2550	
A	1200	
A1	150	
B	385	
C	6485	7450
C1	6760	7745
D	5350	
E	1150	
E1	2560	3045
F	3050	
G	1150	
H1	350	
H2	350	
I	2630	
J	3000	
J1	3050	
K	2675	3175

mm	MRT 2150 /2550	
L	2050	
M	2490	
N	5140	
O	5555	
P	230	
P2	15°	
P3	22°	
Q	5235	
R	4650	
S	4500	
S1	5190	
T	4880	
U	6550	6915
V	950	
Y	12°	
Z	105°	

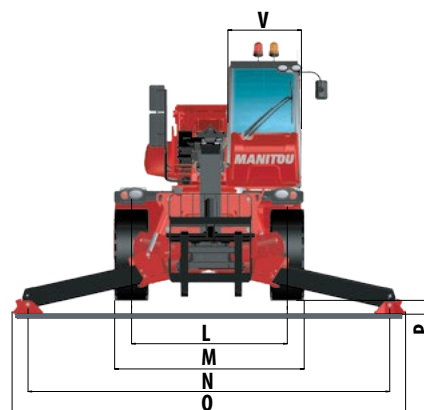



**Rotation on extended stabilizers  
with 365 kg platform**

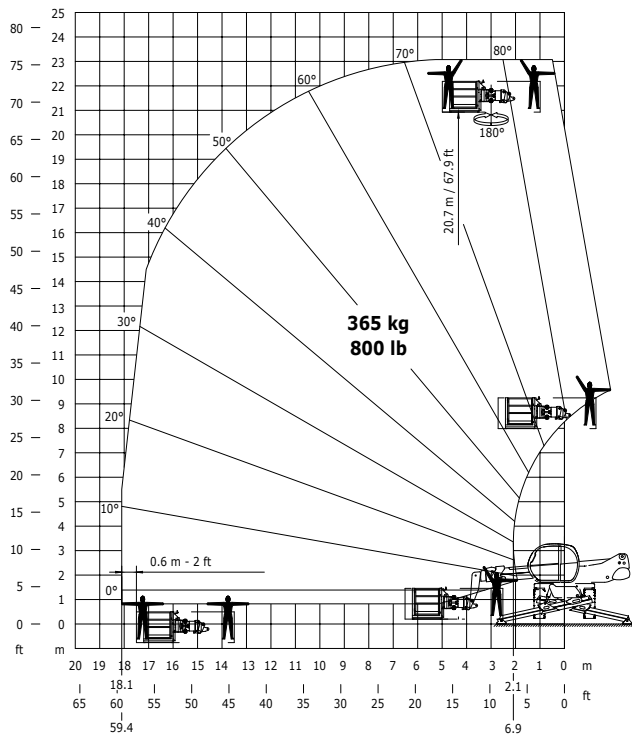

**Rotation on extended stabilizers  
with 1000 kg platform**

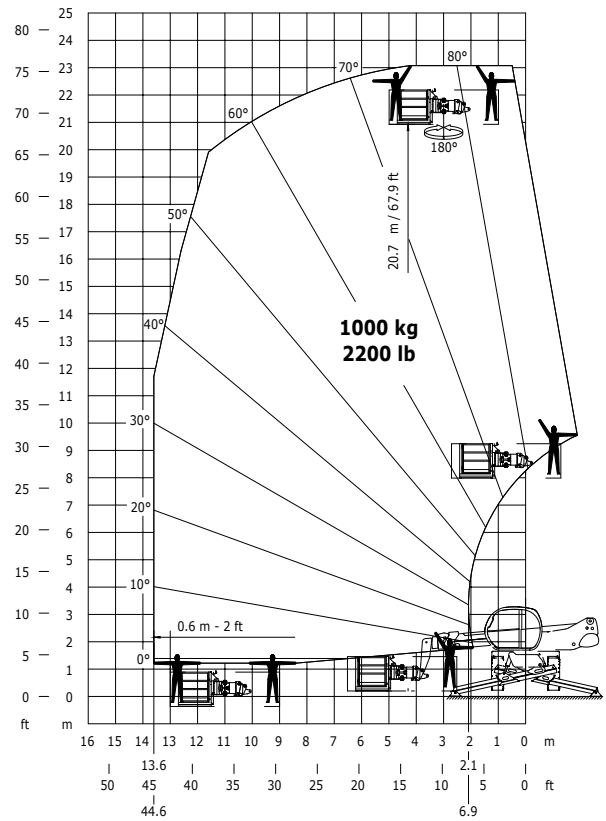

**Rotation on extended stabilizers  
with 5000 kg winch**

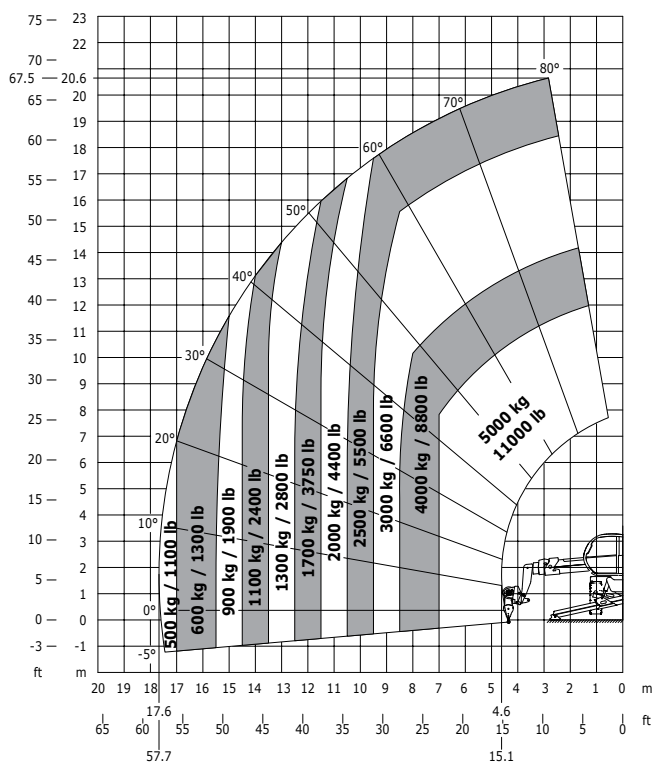



**Rotation on extended stabilizers  
with 365 kg platform**

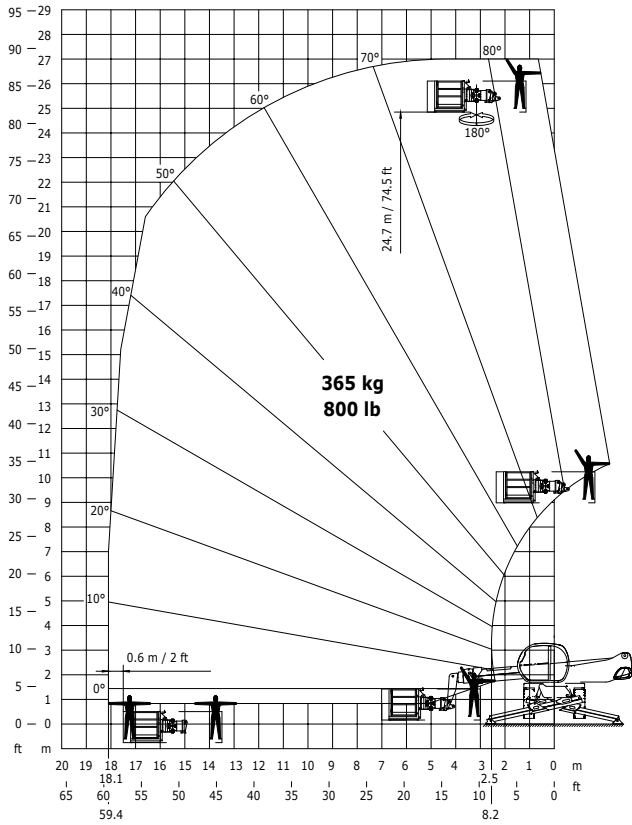

**Rotation on extended stabilizers  
with 1000 kg platform**

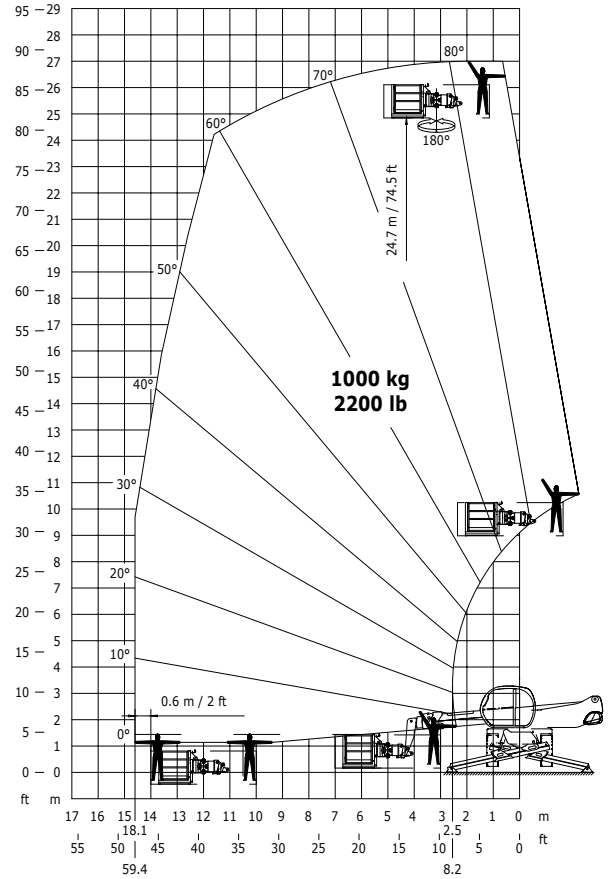

**Rotation on extended stabilizers  
with 5000 kg winch**

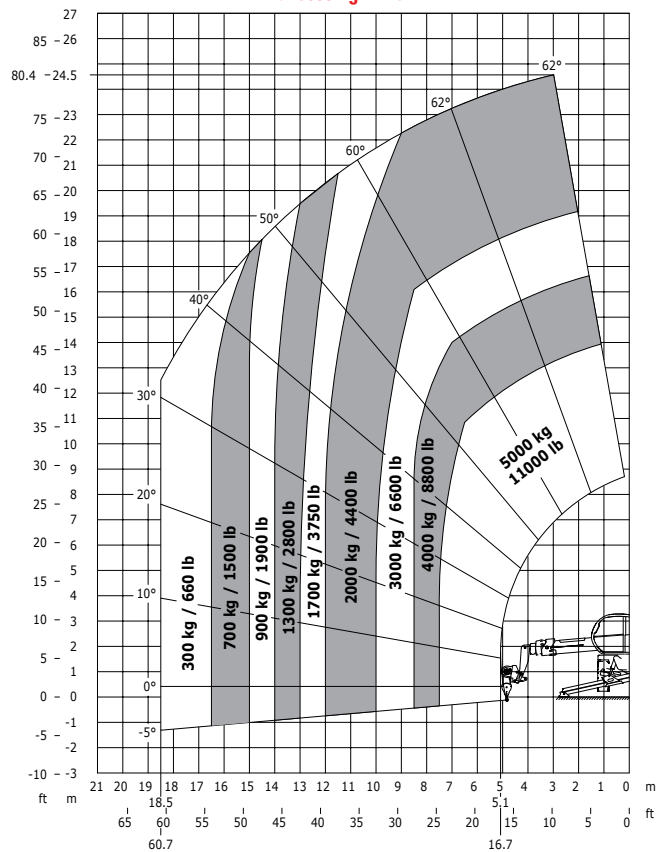

Your MANITOU dealer



Head office :

B.P. 249 - 430 rue de l'Aubinière - 44158 Ancenis Cedex - France

Phone.: +33 (0)2 40 09 10 11 - Fax: +33 (0)2 40 09 10 97

[www.manitou.com](http://www.manitou.com)

