



An Oshkosh Corporation Company

---

# **Illustrated Parts Manual**

## **Compact Crawler**

**X26JA/5    X770AJ/3**

**X26JA/6    X770AJ/4**

**X26JA/7    X770AJ/5**

**X26JA/8    X770AJ/6**

**X26JP/3    X770AJ/8**

**X26JP/4**

**X26JP/5**

**X26JP/6**



**X26JP/8**



**SN C170001399 TO PRESENT**







**31217113**  
January 18, 2023 - Rev J

---

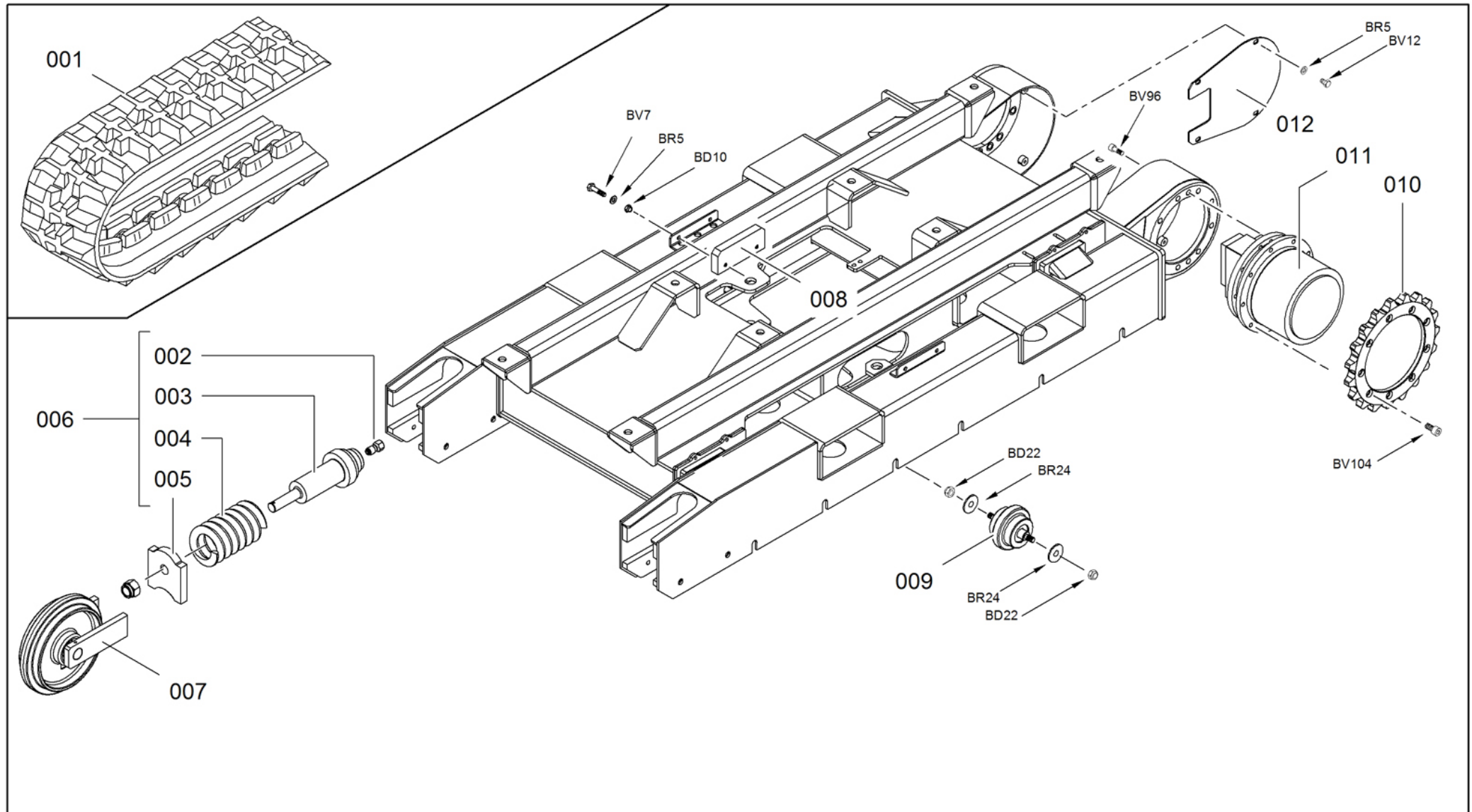

 SOTTOCARRO CINGOLATO  
 TRACKED UNDERCARRIAGE  
 CHENILLARD



 RAUPENFAHRWERK  
 CARRO DE ORUGAS











**Main color codes:**  **J1** - JLG Cream,  **J2** - JLG Orange,  **C4** - Green







 SOTTOCARRO CINGOLATO  
 TRACKED UNDERCARRIAGE  
 CHENILLARD

 RAUPENFAHRWERH  
 CARRO DE ORUGAS



POS	Codice	 Descrizione	 Description	 Designation	 Benennung	 Descripción
1	27589900	CINGOLO	RUBBER TRACK	CHENILLE	RAUPENKETTE	ORUGA
1	2758990B	CINGOLO NO MARKING	RUBBER TRACK NO MARKING	CHENILLE NON MARQUANTE	NICHT MARKIERENDE RAUPENKETTE	ORUGA BLANCA
2	03149200	VALVOLA IDRAULICA	HYDRAULIC VALVE	VALVE HYDRAULIQUE	HYDRAULIKVENTIL	VÁLVULA HIDRÁULICA
3	14265800	CILINDRO TENDICINGOLO COMPLETO	CYLINDER	CYLINDRE	ZYLINDER	CILINDRO
4	04274100	MOLLA TENDICINGOLO	SPRING	RESSORT	KETTENSPIANNFEDER	MUELLE
5	07610700	PIASTRA	PLATE	PLAQUE	PLATTE	PLACA
6	175898A3	SUPPORTO TENDICINGOLO	IDLER SUPPORT	SUPPORT TENDEUR CHENILLE	KETTENSPIANNHALTE RUNG	SOPORTE TENSOR ORUGA
6	175898H2	SUPPORTO TENDICINGOLO	IDLER SUPPORT	SUPPORT TENDEUR CHENILLE	KETTENSPIANNHALTE RUNG	SOPORTE TENSOR ORUGA
7	175983A3	RUOTA TENDICINGOLO	IDLER WHEEL	ROUE TENDEUR DE CHENILLE	KETTENSPIANNRAD	RUEDA TENSOR ORUGA
7	175983H2	RUOTA TENDICINGOLO	IDLER WHEEL	ROUE TENDEUR DE CHENILLE	KETTENSPIANNRAD	RUEDA TENSOR ORUGA
8	04463500	GUIDACINGOLO	TRACKS GUIDE	GUIDAGE CHENILLE	BAHN FÜR DIE KETTE	GUIA ORUGA
9	147310A3	RULLO INFERIORE	CARRIER ROLLER	ROULEAU INFÉRIEUR	TRAGROLLE	RODILLO INFERIOR
9	147310H2	RULLO INFERIORE	CARRIER ROLLER	ROULEAU INFÉRIEUR	TRAGROLLE	RODILLO INFERIOR
10	055609A3	RUOTA DI TRAZIONE	SPROCKET WHEEL	ROUE DE TRACTION	ANTRIEBSRAD	RUEDA DE ARRASTRE
10	055609H2	RUOTA DI TRAZIONE	SPROCKET WHEEL	ROUE DE TRACTION	ANTRIEBSRAD	RUEDA DE ARRASTRE
11	264491A3	MOTORIDUTTORE	GEAR MOTOR	MOTORÉDUCTEUR	GETRIEBEMOTOR	MOTORREDUCTOR
11	264491H2	MOTORIDUTTORE	GEAR MOTOR	MOTORÉDUCTEUR	GETRIEBEMOTOR	MOTORREDUCTOR
12	063949A3	COPERCHIO	COVER	COUVERCLE	DECKEL	TAPA
12	063949H2	COPERCHIO	COVER	COUVERCLE	DECKEL	TAPA

Main color codes:  J1 - JLG Cream,  J2 - JLG Orange,  C4 - Green

 ALLARGAMENTO IDRAULICO  
 HYDRAULIC EXTENSION  
 ECARTEMENT HYDRAULIQUE

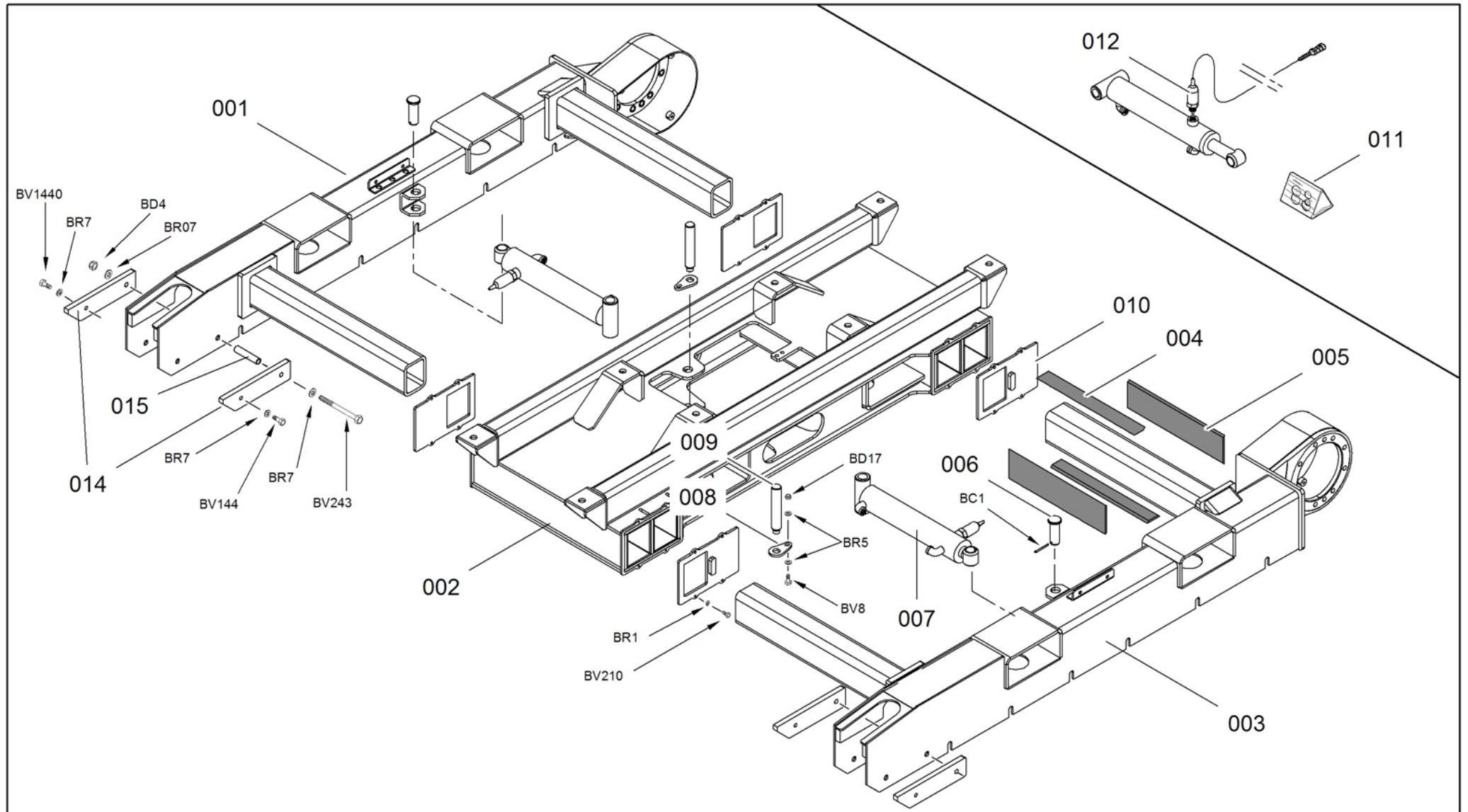
HYDR. SPURWEITENVER STELLINRICHTUNG   
 EXTENSION HIDRAULICA 





Main color codes:  J1 - JLG Cream,  J2 - JLG Orange,  C4 - Green

 ALLARGAMENTO IDRAULICO

 HYDRAULIC EXTENSION

 ECARTEMENT HYDRAULIQUE
HYDR. SPURWEITENVER STELLEINRICHTUNG EXTENSION HIDRAULICA 





POS	Codice	 Descrizione	 Description	 Designation	 Benennung	 Descripción
1	375181A3	ASSIEME LONGHERONE DESTRO	RIGHT SIDE FRAME ASSEMBLY	ENSEMBLE CHÂSSIS LATÉRAL LONGERON DROIT	FAHRSCIFF RECHTS	ORUGA DERECHA
1	375181H2	ASSIEME LONGHERONE DESTRO	RIGHT SIDE FRAME ASSEMBLY	ENSEMBLE CHÂSSIS LATÉRAL LONGERON DROIT	FAHRSCIFF RECHTS	ORUGA DERECHA
2	374942A3	STRUTTURA CENTRALE SOTTOCARRO	CENTRAL STRUCTURE UNDERCARRIAGE	STRUCTURE CENTRALE DU CHENILLARD	ZENTRALSTRUKTUR DES FAHRWERKS	ESTRUCTURA CENTRAL CARRO DE ORUGAS
2	374942H2	STRUTTURA CENTRALE SOTTOCARRO	CENTRAL STRUCTURE UNDERCARRIAGE	STRUCTURE CENTRALE DU CHENILLARD	ZENTRALSTRUKTUR DES FAHRWERKS	ESTRUCTURA CENTRAL CARRO DE ORUGAS
3	375182A3	ASSIEME LONGHERONE SINISTRO	LEFT SIDE FRAME ASSEMBLY	ENSEMBLE CHÂSSIS LATÉRAL LONG. GAUCHE	FAHRSCIFF LINKS	ORUGA IZQUIERDA
3	375182H2	ASSIEME LONGHERONE SINISTRO	LEFT SIDE FRAME ASSEMBLY	ENSEMBLE CHÂSSIS LATÉRAL LONG. GAUCHE	FAHRSCIFF LINKS	ORUGA IZQUIERDA
4	06406700	GUIDA ALLARGAMENTO	EXPANSION GUIDE	GLISSIÈRE ÉLARGISSEMENT	FÜHRUNGSVERBREIT ERUNG	GUÍA DE EXTENSIÓN
5	07589500	GUIDA ALLARGAMENTO	EXPANSION GUIDE	GLISSIÈRE ÉLARGISSEMENT	GLEITFÜHRUNG SPURVERBREITERUN G	GUÍA DE EXTENSIÓN
6	04256300	SPINA	PIN	CHEVILLE	STIFT	CLAVIJA
7	274943A3	CILINDRO ALLARGAMENTO SOTTOCARRO	UNDERCARRIAGE WIDENING CYLINDER	VERIN ELARGISSEMENT	SPURVERBREITERUN GSZYLINDER	CILINDRO ENSANCHAMIENTO
7	274943H2	CILINDRO ALLARGAMENTO SOTTOCARRO	UNDERCARRIAGE WIDENING CYLINDER	VERIN ELARGISSEMENT	SPURVERBREITERUN GSZYLINDER	CILINDRO ENSANCHAMIENTO
9	07517900	SPINA	PIN	AXE	STIFT	CLAVIJA
10	374937A3	COPERCHIO GUIDE ALLARGAMENTO	EXPANSION GUIDE COVER	COUVERCLE GLISSIÈRE ELARGISSEMENT	DECKEL GLEITFÜHRUNG	TAPA GUÍA ENSANCHAMIENTO



Main color codes:  J1 - JLG Cream,  J2 - JLG Orange,  C4 - Green

 ALLARGAMENTO IDRAULICO

 HYDRAULIC EXTENSION

 ECARTEMENT HYDRAULIQUE
HYDR. SPURWEITENVER STELLEINRICHTUNG EXTENSION HIDRAULICA 

POS	Codice	 Descrizione	 Description	 Designation	 Benennung	 Descripción
10	374937H2	COPERCHIO GUIDE ALLARGAMENTO	EXPANSION GUIDE COVER	COUVERCLE GLISSIÈRE ELARGISSEMENT	DECKEL GLEITFÜHRUNG	TAPA GUÍA ENSANCHAMIENTO
11	2749430001	KIT GUARNIZIONI CILINDRO ALLARGAMENTO SOTTOCARRO LL2614- X26JP-X770AJ	SEAL KIT	KIT DE JOINTS	DICHTSATZ	KIT JUNTAS
12	17329500	MICROINTERRUPTOR E ALLARGAMENTO CARRO N/O COMPLETO DI CAVO E CONNETTORE	WIDENING SYSTEM MICRO SWITCH N/O CONTACT WITH CABLE AND CONNECTOR	MICRO INTERRUPTEUR ELARGISSEMENT AVEC CABLE ET CONNECTEUR	MIKROSCHALTER SPURVERBREITERUN G MIT KABEL UND STECKER	MICROINTERRUPTOR ENSANCHAMIENTO CON CABLE Y CONECTOR
14	075194A3	PIASTRA	PLATE	PLAQUE	PLATTE	PLACA
14	075194H2	PIASTRA	PLATE	PLAQUE	PLATTE	PLACA
15	07610500	DISTANZIALE	SPACER	ENTRETOISE	ABSTANDHALTER	ESPACIADOR



Main color codes:  J1 - JLG Cream,  J2 - JLG Orange,  C4 - Green















 BASE TORRETTA TURRET BASE BASE TOURELLEARBEITSTURM BASE TORRETTA GIRATORIA 



POS	Codice	 Descrizione	 Description	 Designation	 Benennung	 Descripción
1	15120100	FILTRO OLIO IDRAULICO COMPLETO	COMPLETE HYDRAULIC OIL FILTER	FILTRE À HUILE	HYDARULIKÖLFILTE R	FILTRO ACEITE HIDRÁULICO
2	05120200	CARTUCCIA FILTRO OLIO IDRAULICO	HYDRAULIC FILTER	CARTOUCHE FILTRE À HUILE	ÖLFILTEREINSATZ	CARTUCHO FILTRO ACEITE
3	05061800	LIVELLO OLIO	OIL LEVEL	NIVEAU HUILE	ÖLSTAND	NIVEL ACEITE
4	174930A3	SERBATOIO OLIO COMPLETO	OIL TANK COMPLETE	HUILE COMPLETE	OIL TANK COMPLETE	ACEITE COMPLETA
4	174930A5	SERBATOIO OLIO COMPLETO	OIL TANK COMPLETE	HUILE COMPLETE	OIL TANK COMPLETE	ACEITE COMPLETA
4	174930A6	SERBATOIO OLIO COMPLETO	OIL TANK COMPLETE	HUILE COMPLETE	OIL TANK COMPLETE	ACEITE COMPLETA
4	174930A7	SERBATOIO OLIO COMPLETO	OIL TANK COMPLETE	HUILE COMPLETE	OIL TANK COMPLETE	ACEITE COMPLETA
4	174930B9	SERBATOIO OLIO COMPLETO	OIL TANK COMPLETE	HUILE COMPLETE	OIL TANK COMPLETE	ACEITE COMPLETA
4	174930BP	SERBATOIO OLIO COMPLETO	OIL TANK COMPLETE	HUILE COMPLETE	OIL TANK COMPLETE	ACEITE COMPLETA
4	174930C4	SERBATOIO OLIO COMPLETO	OIL TANK COMPLETE	HUILE COMPLETE	OIL TANK COMPLETE	ACEITE COMPLETA
4	174930CO	SERBATOIO OLIO COMPLETO	OIL TANK COMPLETE	HUILE COMPLETE	OIL TANK COMPLETE	ACEITE COMPLETA
4	174930DI	SERBATOIO OLIO COMPLETO	OIL TANK COMPLETE	HUILE COMPLETE	OIL TANK COMPLETE	ACEITE COMPLETA
4	174930EM	SERBATOIO OLIO COMPLETO	OIL TANK COMPLETE	RESERVOIR HUILE	ÖLTANK	DEPOSITO ACEITE
4	174930EW	SERBATOIO OLIO COMPLETO	OIL TANK COMPLETE	HUILE COMPLETE	OIL TANK COMPLETE	ACEITE COMPLETA
4	174930GB	SERBATOIO OLIO COMPLETO	OIL TANK COMPLETE	HUILE COMPLETE	OIL TANK COMPLETE	ACEITE COMPLETA
4	174930J2	SERBATOIO OLIO COMPLETO	OIL TANK COMPLETE	RESERVOIR HUILE	ÖLTANK	DEPOSITO ACEITE
5	05611800	TAPPO OLIO	OIL PLUG	BOUCHON D'HUILE	ÖLDECKEL	TAPÓN ACEITE
6	075800A3	COPERCHIO	COVER	COUVERCLE	DECKEL	TAPA

Main color codes:  J1 - JLG Cream,  J2 - JLG Orange,  C4 - Green











 BASE TORRETTA TURRET BASE BASE TOURELLEARBEITSTURM BASE TORRETTA GIRATORIA 

POS	Codice	 Descrizione	 Description	 Designation	 Benennung	 Descripción
6	075800A5	COPERCHIO	COVER	COUVERCLE	DECKEL	TAPA
6	075800A6	COPERCHIO	COVER	COUVERCLE	DECKEL	TAPA
6	075800A7	COPERCHIO	COVER	COUVERCLE	DECKEL	TAPA
6	075800B9	COPERCHIO	COVER	COUVERCLE	DECKEL	TAPA
6	075800BP	COPERCHIO	COVER	COUVERCLE	DECKEL	TAPA
6	075800C4	COPERCHIO	COVER	COUVERCLE	DECKEL	TAPA
6	075800CO	COPERCHIO	COVER	COUVERCLE	DECKEL	TAPA
6	075800DI	COPERCHIO	COVER	COUVERCLE	DECKEL	TAPA
6	075800EM	COPERCHIO	COVER	COUVERCLE	DECKEL	TAPA
6	075800EW	COPERCHIO	COVER	COUVERCLE	DECKEL	TAPA
6	075800GB	COPERCHIO	COVER	COUVERCLE	DECKEL	TAPA
6	075800J2	COPERCHIO	COVER	COUVERCLE	DECKEL	TAPA
7	07343200	VITE IMPERDIBILE ZIGRINATA CORTA	SHORT IMPERDIBLE KNURLED SCREW	VIS IMPERDABLE	SCHRAUBE	TORNILLO IMPERDIBLE
8	07343400	AGGANCIO PER VITE IMPERDIBILE	COUPLING FOR IMPERDIBLE SCREW	CROCHET VIS IMPERDABLE	HAKEN FÜR SCHRAUBE	GANCHO TORNILLO IMPERDIBLE
9	07343300	RICETTACOLO PER VITE IMPERDIBILE	RECEPTACLE FOR IMPERDIBLE SCREW	PRISE DE VIS POUR VIS IMPERDABLE	AUFNAHME FÜR SCHRAUBE	REFUGIO TORNILLO IMPERDIBLE
10	174927A3	BASE PIATTAFORMA	PLATFORM BASE	BASE PLATEFORME	ARBEITSBÜHNENUNT ERGESTELL	BASE PLATAFORMA
10	174927H2	BASE PIATTAFORMA	PLATFORM BASE	BASE PLATEFORME	ARBEITSBÜHNENUNT ERGESTELL	BASE PLATAFORMA
11	374933A3	SUPPORTO MOTORE DIESEL	DIESEL ENGINE SUPPORT	DIESEL SUPPORT MOTEUR	DIESEL MOTOR SUPPORT	MOTOR DIESEL DE APOYO
11	374933A5	SUPPORTO MOTORE DIESEL	DIESEL ENGINE SUPPORT	DIESEL SUPPORT MOTEUR	DIESEL MOTOR SUPPORT	MOTOR DIESEL DE APOYO
11	374933A6	SUPPORTO MOTORE DIESEL	DIESEL ENGINE SUPPORT	DIESEL SUPPORT MOTEUR	DIESEL MOTOR SUPPORT	MOTOR DIESEL DE APOYO
11	374933B9	SUPPORTO MOTORE DIESEL	DIESEL ENGINE SUPPORT	DIESEL SUPPORT MOTEUR	DIESEL MOTOR SUPPORT	MOTOR DIESEL DE APOYO
11	374933BP	SUPPORTO MOTORE DIESEL	DIESEL ENGINE SUPPORT	DIESEL SUPPORT MOTEUR	DIESEL MOTOR SUPPORT	MOTOR DIESEL DE APOYO





Main color codes:  J1 - JLG Cream,  J2 - JLG Orange,  C4 - Green



 BASE TORRETTA TURRET BASE BASE TOURELLEARBEITSTURM BASE TORRETTA GIRATORIA 

POS	Codice	 Descrizione	 Description	 Designation	 Benennung	 Descripción
11	374933CO	SUPPORTO MOTORE DIESEL	DIESEL ENGINE SUPPORT	DIESEL SUPPORT MOTEUR	DIESEL MOTOR SUPPORT	MOTOR DIESEL DE APOYO
11	374933DI	SUPPORTO MOTORE DIESEL	DIESEL ENGINE SUPPORT	DIESEL SUPPORT MOTEUR	DIESEL MOTOR SUPPORT	MOTOR DIESEL DE APOYO
11	374933EM	SUPPORTO MOTORE DIESEL	DIESEL ENGINE SUPPORT	SUPPORT MOTEUR DIESEL	DIESEL MOTORHALTERUNG	SUPORTE MOTOR DIESEL
11	374933EW	SUPPORTO MOTORE DIESEL	DIESEL ENGINE SUPPORT	DIESEL SUPPORT MOTEUR	DIESEL MOTOR SUPPORT	MOTOR DIESEL DE APOYO
11	374933GB	SUPPORTO MOTORE DIESEL	DIESEL ENGINE SUPPORT	DIESEL SUPPORT MOTEUR	DIESEL MOTOR SUPPORT	MOTOR DIESEL DE APOYO
11	374933J2	SUPPORTO MOTORE DIESEL	DIESEL ENGINE SUPPORT	SUPPORT MOTEUR DIESEL	DIESEL MOTORHALTERUNG	SUPORTE MOTOR DIESEL
11	376952D1	SUPPORTO COMPONENTI ELETTRICI	ELECTRIC COMPONENT SUPPORT	SUPPORT COMPOSANTS ÉLECTRIQUES	HALTERUNG E-TEILE	SOPORTE COMPONENTES ELÉCTRICOS
12	075999A3	CARTER	PROTECTION	PROTECTION	SCHUTZ	PROTECCIÓN
12	075999H2	CARTER	PROTECTION	PROTECTION	SCHUTZ	PROTECCIÓN
13	05442500	RISCONTRO	FASTENER LOCATOR	PLAQUE POUR AGRAFAGE	ANSCHLAG	GANCHO
14	05442600	CHIUSURA A GANCIO	HOOK FASTENING	FERMETURE À CROCHET	HAKENVERSCHLUSS	GANCHO DE CIERRE
15	081100A6	COPERCHIO FILTRO ARIA	AIR FILTER COVER	COUVERCLE	DECKEL	TAPA
15	081100EW	COPERCHIO FILTRO ARIA	AIR FILTER COVER	COUVERCLE	DECKEL	TAPA
15	081100GB	COPERCHIO FILTRO ARIA	AIR FILTER COVER	COUVERCLE	DECKEL	TAPA
15	081100J2	COPERCHIO FILTRO ARIA	AIR FILTER COVER	COUVERCLE	DECKEL	TAPA
15	374935A3	COPERCHIO	COVER	COUVERCLE	DECKE	TAPA
15	374935A5	COPERCHIO	COVER	COUVERCLE	DECKEL	TAPA
15	374935A6	COPERCHIO	COVER	COUVERCLE	DECKEL	TAPA
15	374935B9	COPERCHIO	COVER	COUVERCLE	DECKEL	TAPA
15	374935BP	COPERCHIO	COVER	COUVERCLE	DECKEL	TAPA

Main color codes:  J1 - JLG Cream,  J2 - JLG Orange,  C4 - Green

 BASE TORRETTA TURRET BASE BASE TOURELLEARBEITSTURM BASE TORRETTA GIRATORIA 





POS	Codice	 Descrizione	 Description	 Designation	 Benennung	 Descripción
15	374935CO	COPERCHIO	COVER	COUVERCLE	DECKEL	TAPA
15	374935DI	COPERCHIO	COVER	COUVERCLE	DECKEL	TAPA
15	374935EM	COVER	COVER	COUVERCLE	DECKEL	TAPA
15	374935EW	COPERCHIO	COVER	COUVERCLE	DECKEL	TAPA
15	374935J2	COVER	COVER	COUVERCLE	DECKEL	TAPA
15	381088A6	COPERCHIO RADIATORE	RADIATOR COVER	COUVERCLE	DECKEL	TAPA
15	381088EW	COPERCHIO RADIATORE	RADIATOR COVER	COUVERCLE	DECKEL	TAPA
15	381088GB	COPERCHIO RADIATORE	RADIATOR COVER	COUVERCLE	DECKEL	TAPA
15	381088J2	COPERCHIO RADIATORE	RADIATOR COVER	COUVERCLE	DECKEL	TAPA
16	075705A3	COPERCHIO	COVER	COUVERCLE	DECKEL	TAPA
16	075705A5	COPERCHIO	COVER	COUVERCLE	DECKEL	TAPA
16	075705A6	COPERCHIO	COVER	COUVERCLE	DECKEL	TAPA
16	075705B9	COPERCHIO	COVER	COUVERCLE	DECKEL	TAPA
16	075705BP	COPERCHIO	COVER	COUVERCLE	DECKEL	TAPA
16	075705CO	COPERCHIO	COVER	COUVERCLE	DECKEL	TAPA
16	075705DI	COPERCHIO	COVER	COUVERCLE	DECKEL	TAPA
16	075705EM	COVER	COVER	COUVERCLE	DECKEL	TAPA
16	075705EW	COPERCHIO	COVER	COUVERCLE	DECKEL	TAPA
16	075705GB	COPERCHIO	COVER	COUVERCLE	DECKEL	TAPA
16	075705J2	COVER	COVER	COUVERCLE	DECKEL	TAPA
17	374934A3	PROTEZIONE FISSA MOTORE DIESEL	DIESEL ENGINE PROTECTION	DIESEL PROTECTION MOTEUR FIXE	DIESEL MOTOR SCHUTZ FIXED	PROTECCIÓN DEL MOTOR DIESEL FIJO
17	374934A5	PROTEZIONE FISSA MOTORE DIESEL	DIESEL ENGINE PROTECTION	DIESEL PROTECTION MOTEUR FIXE	DIESEL MOTOR SCHUTZ FIXED	PROTECCIÓN DEL MOTOR DIESEL FIJO
17	374934A6	PROTEZIONE FISSA MOTORE DIESEL	DIESEL ENGINE PROTECTION	DIESEL PROTECTION MOTEUR FIXE	DIESEL MOTOR SCHUTZ FIXED	PROTECCIÓN DEL MOTOR DIESEL FIJO
17	374934B9	PROTEZIONE FISSA MOTORE DIESEL	DIESEL ENGINE PROTECTION	DIESEL PROTECTION MOTEUR FIXE	DIESEL MOTOR SCHUTZ FIXED	PROTECCIÓN DEL MOTOR DIESEL FIJO



Main color codes:  J1 - JLG Cream,  J2 - JLG Orange,  C4 - Green

 BASE TORRETTA



 TURRET BASE



 BASE TOURELLE
ARBEITSTURM BASE TORRETTA GIRATORIA 

POS	Codice	 Descrizione	 Description	 Designation	 Benennung	 Descripción
17	374934BP	PROTEZIONE FISSA MOTORE DIESEL	DIESEL ENGINE PROTECTION	DIESEL PROTECTION MOTEUR FIXE	DIESEL MOTOR SCHUTZ FIXED	PROTECCIÓN DEL MOTOR DIESEL FIJO
17	374934CO	PROTEZIONE FISSA MOTORE DIESEL	DIESEL ENGINE PROTECTION	DIESEL PROTECTION MOTEUR FIXE	DIESEL MOTOR SCHUTZ FIXED	PROTECCIÓN DEL MOTOR DIESEL FIJO
17	374934DI	PROTEZIONE FISSA MOTORE DIESEL	DIESEL ENGINE PROTECTION	DIESEL PROTECTION MOTEUR FIXE	DIESEL MOTOR SCHUTZ FIXED	PROTECCIÓN DEL MOTOR DIESEL FIJO
17	374934EM	PROTEZIONE FISSA MOTORE DIESEL	DIESEL ENGINE PROTECTION	PROTECTION MOTEUR DIESEL	DIESEL MOTORSCHUTZ	PROTECCIÓN MOTOR DIESEL
17	374934EW	PROTEZIONE FISSA MOTORE DIESEL	DIESEL ENGINE PROTECTION	DIESEL PROTECTION MOTEUR FIXE	DIESEL MOTOR SCHUTZ FIXED	PROTECCIÓN DEL MOTOR DIESEL FIJO
17	374934J2	PROTEZIONE FISSA MOTORE DIESEL	DIESEL ENGINE PROTECTION	PROTECTION MOTEUR DIESEL	DIESEL MOTORSCHUTZ	PROTECCIÓN MOTOR DIESEL
17	381092A6	PROTEZIONE MOBILE DESTRA	RIGHT MOBILE COVER	PROTECTION MOTEUR DROITE	MOTORSCHUTZ RECHTS	PROTECCIÓN MOTOR DERECHA
17	381092EW	PROTEZIONE MOBILE DESTRA	RIGHT MOBILE COVER	PROTECTION MOTEUR DROITE	MOTORSCHUTZ RECHTS	PROTECCIÓN MOTOR DERECHA
17	381092GB	PROTEZIONE MOBILE DESTRA	RIGHT MOBILE COVER	PROTECTION MOTEUR DROITE	MOTORSCHUTZ RECHTS	PROTECCIÓN MOTOR DERECHA
17	381092J2	PROTEZIONE MOBILE DESTRA	RIGHT MOBILE COVER	PROTECTION MOTEUR DROITE JLG ORANGE	MOTORSCHUTZ RECHTS JLG ORANGE	PROTECCIÓN MOTOR DERECHA JLG ORANGE
17	381093A6	PROTEZIONE MOBILE SINSITRA	LEFT MOBILE COVER	PROTECTION MOTEUR GAUCHE	MOTORSCHUTZ LINKS	PROTECCIÓN MOTOR IZQUIERDA
17	381093EW	PROTEZIONE MOBILE SINSITRA	LEFT MOBILE COVER	PROTECTION MOTEUR GAUCHE JLG ORANGE	MOTORSCHUTZ LINKS JLG ORANGE	PROTECCIÓN MOTOR IZQUIERDA JLG ORANGE
17	381093GB	PROTEZIONE MOBILE SINSITRA	LEFT MOBILE COVER	PROTECTION MOTEUR GAUCHE RAL2004	MOTORSCHUTZ LINKS RAL2004	PROTECCIÓN MOTOR IZQUIERDA RAL2004
17	381093J2	PROTEZIONE MOBILE SINSITRA	LEFT MOBILE COVER	PROTECTION MOTEUR GAUCHE JLG ORANGE	MOTORSCHUTZ LINKS JLG ORANGE	PROTECCIÓN MOTOR IZQUIERDA JLG ORANGE

Main color codes:  J1 - JLG Cream,  J2 - JLG Orange,  C4 - Green



 BASE TORRETTA TURRET BASE BASE TOURELLEARBEITSTURM BASE TORRETTA GIRATORIA 

POS	Codice	 Descrizione	 Description	 Designation	 Benennung	 Descripción
18	07189900	CERNIERA A OSCILLAZIONE LIBERA	HINGE SWING FREE	CHARNIÈRE	SCHARNIER	BISAGRA
19	181087A6	PROTEZIONE FISSA MOTORE DIESEL COMPLETA	COMPLETE DIESEL ENGINE PROTECTION	PROTECTION	SCHUTZABDECKUNG	PROTECCIÓN
19	181087EW	PROTEZIONE FISSA MOTORE DIESEL COMPLETA	COMPLETE DIESEL ENGINE PROTECTION	PROTECTION RAL 2004	SCHUTZABDECKUNG RAL 2004	PROTECCIÓN
19	181087GB	PROTEZIONE FISSA MOTORE DIESEL COMPLETA	COMPLETE DIESEL ENGINE PROTECTION	PROTECTION RAL 2004	SCHUTZABDECKUNG RAL 2004	PROTECCIÓN
19	181087J2	PROTEZIONE FISSA MOTORE DIESEL COMPLETA	COMPLETE DIESEL ENGINE PROTECTION	PROTECTION JLG ORANGE	SCHUTZABDECKUNG JLG ORANGE	PROTECCIÓN JLG ORANGE
19	374936A3	PROTEZIONE RIMOVIBILE MOTORE DIESEL	REMOVABLE PROTECTION DIESEL ENGINE	AMOVIBLE PROTECTION MOTEUR DIESEL	REMOVABLE SCHUTZ DIESEL MOTOR	PROTECCIÓN DESMONTABLE MOTOR DIESEL
19	374936A5	PROTEZIONE RIMOVIBILE MOTORE DIESEL	REMOVABLE PROTECTION DIESEL ENGINE	AMOVIBLE PROTECTION MOTEUR DIESEL	REMOVABLE SCHUTZ DIESEL MOTOR	PROTECCIÓN DESMONTABLE MOTOR DIESEL
19	374936A6	PROTEZIONE RIMOVIBILE MOTORE DIESEL	REMOVABLE PROTECTION DIESEL ENGINE	AMOVIBLE PROTECTION MOTEUR DIESEL	REMOVABLE SCHUTZ DIESEL MOTOR	PROTECCIÓN DESMONTABLE MOTOR DIESEL
19	374936B9	PROTEZIONE RIMOVIBILE MOTORE DIESEL	REMOVABLE PROTECTION DIESEL ENGINE	AMOVIBLE PROTECTION MOTEUR DIESEL	REMOVABLE SCHUTZ DIESEL MOTOR	PROTECCIÓN DESMONTABLE MOTOR DIESEL
19	374936BP	PROTEZIONE RIMOVIBILE MOTORE DIESEL	REMOVABLE PROTECTION DIESEL ENGINE	AMOVIBLE PROTECTION MOTEUR DIESEL	REMOVABLE SCHUTZ DIESEL MOTOR	PROTECCIÓN DESMONTABLE MOTOR DIESEL
19	374936CO	PROTEZIONE RIMOVIBILE MOTORE DIESEL	REMOVABLE PROTECTION DIESEL ENGINE	AMOVIBLE PROTECTION MOTEUR DIESEL	REMOVABLE SCHUTZ DIESEL MOTOR	PROTECCIÓN DESMONTABLE MOTOR DIESEL

Main color codes:  J1 - JLG Cream,  J2 - JLG Orange,  C4 - Green





 BASE TORRETTA TURRET BASE BASE TOURELLEARBEITSTURM BASE TORRETTA GIRATORIA 



POS	Codice	 Descrizione	 Description	 Designation	 Benennung	 Descripción
19	374936DI	PROTEZIONE RIMOVIBILE MOTORE DIESEL	REMOVABLE PROTECTION DIESEL ENGINE	AMOVIBLE PROTECTION MOTEUR DIESEL	REMOVABLE SCHUTZ DIESEL MOTOR	PROTECCIÓN DESMONTABLE MOTOR DIESEL
19	374936EM	PROTEZIONE RIMOVIBILE MOTORE DIESEL	REMOVABLE PROTECTION DIESEL ENGINE	PROTECTION MOTEUR DIESEL	DIESEL MOTORSCHUTZ	PROTECCIÓN DESMONTABLE MOTOR DIESEL
19	374936EW	PROTEZIONE RIMOVIBILE MOTORE DIESEL	REMOVABLE PROTECTION DIESEL ENGINE	AMOVIBLE PROTECTION MOTEUR DIESEL	REMOVABLE SCHUTZ DIESEL MOTOR	PROTECCIÓN DESMONTABLE MOTOR DIESEL
19	374936J2	PROTEZIONE RIMOVIBILE MOTORE DIESEL	REMOVABLE PROTECTION DIESEL ENGINE	PROTECTION MOTEUR DIESEL	DIESEL MOTORSCHUTZ	PROTECCIÓN DESMONTABLE MOTOR DIESEL
20	377077A3	SCATOLA COMPONENTI ELETTRICI SALDATA	ELECTRICAL COMPONENTS SEALED BOX	COMPOSANTS ÉLECTRIQUES BOÎTE SCELLÉE	ELEKTROKOMPONEN TEN SEALED BOX	COMPONENTES ELÉCTRICOS CAJA SELLADA
20	377077A5	SCATOLA COMPONENTI ELETTRICI SALDATA	ELECTRICAL COMPONENTS SEALED BOX	COMPOSANTS ÉLECTRIQUES BOÎTE SCELLÉE	ELEKTROKOMPONEN TEN SEALED BOX	COMPONENTES ELÉCTRICOS CAJA SELLADA
20	377077A6	SCATOLA COMPONENTI ELETTRICI SALDATA	ELECTRICAL COMPONENTS SEALED BOX	COMPOSANTS ÉLECTRIQUES BOÎTE SCELLÉE	ELEKTROKOMPONEN TEN SEALED BOX	COMPONENTES ELÉCTRICOS CAJA SELLADA
20	377077A7	SCATOLA COMPONENTI ELETTRICI SALDATA	ELECTRICAL COMPONENTS SEALED BOX	COMPOSANTS ÉLECTRIQUES BOÎTE SCELLÉE	ELEKTROKOMPONEN TEN SEALED BOX	COMPONENTES ELÉCTRICOS CAJA SELLADA
20	377077B9	SCATOLA COMPONENTI ELETTRICI SALDATA	ELECTRICAL COMPONENTS SEALED BOX	COMPOSANTS ÉLECTRIQUES BOÎTE SCELLÉE	ELEKTROKOMPONEN TEN SEALED BOX	COMPONENTES ELÉCTRICOS CAJA SELLADA
20	377077BP	SCATOLA COMPONENTI ELETTRICI SALDATA	ELECTRICAL COMPONENTS SEALED BOX	COMPOSANTS ÉLECTRIQUES BOÎTE SCELLÉE	ELEKTROKOMPONEN TEN SEALED BOX	COMPONENTES ELÉCTRICOS CAJA SELLADA
20	377077C4	SCATOLA COMPONENTI ELETTRICI SALDATA	ELECTRICAL COMPONENTS SEALED BOX	COMPOSANTS ÉLECTRIQUES BOÎTE SCELLÉE	ELEKTROKOMPONEN TEN SEALED BOX	COMPONENTES ELÉCTRICOS CAJA SELLADA

Main color codes:  J1 - JLG Cream,  J2 - JLG Orange,  C4 - Green









 BASE TORRETTA TURRET BASE BASE TOURELLEARBEITSTURM BASE TORRETTA GIRATORIA 



POS	Codice	 Descrizione	 Description	 Designation	 Benennung	 Descripción
20	377077CO	SCATOLA COMPONENTI ELETTRICI SALDATA	ELECTRICAL COMPONENTS SEALED BOX	COMPOSANTS ÉLECTRIQUES BOÎTE SCELLÉE	ELEKTROKOMPONEN TEN SEALED BOX	COMPONENTES ELÉCTRICOS CAJA SELLADA
20	377077DI	SCATOLA COMPONENTI ELETTRICI SALDATA	ELECTRICAL COMPONENTS SEALED BOX	COMPOSANTS ÉLECTRIQUES BOÎTE SCELLÉE	ELEKTROKOMPONEN TEN SEALED BOX	COMPONENTES ELÉCTRICOS CAJA SELLADA
20	377077EM	SCATOLA COMPONENTI ELETTRICI SALDATA	ELECTRICAL COMPONENTS SEALED BOX	COMPOSANTS ÉLECTRIQUES BOÎTE SCELLÉE	ELEKTROKOMPONEN TEN SEALED BOX	COMPONENTES ELÉCTRICOS CAJA SELLADA
20	377077EW	SCATOLA COMPONENTI ELETTRICI SALDATA	ELECTRICAL COMPONENTS SEALED BOX	COMPOSANTS ÉLECTRIQUES BOÎTE SCELLÉE	ELEKTROKOMPONEN TEN SEALED BOX	COMPONENTES ELÉCTRICOS CAJA SELLADA
20	377077GB	SCATOLA COMPONENTI ELETTRICI SALDATA	ELECTRICAL COMPONENTS SEALED BOX	COMPOSANTS ÉLECTRIQUES BOÎTE SCELLÉE	ELEKTROKOMPONEN TEN SEALED BOX	COMPONENTES ELÉCTRICOS CAJA SELLADA
20	377077J2	SCATOLA COMPONENTI ELETTRICI SALDATA	ELECTRICAL COMPONENTS SEALED BOX	COMPOSANTS ÉLECTRIQUES BOÎTE SCELLÉE	ELEKTROKOMPONEN TEN SEALED BOX	COMPONENTES ELÉCTRICOS CAJA SELLADA
21	075820A3	COPERCHIO	COVER	COUVERCLE	DECKEL	TAPA
21	075820A5	COPERCHIO	COVER	COUVERCLE	DECKEL	TAPA
21	075820A6	COPERCHIO	COVER	COUVERCLE	DECKEL	TAPA
21	075820A7	COVER	COVER	COUVERCLE	DECKEL	TAPA
21	075820B9	COPERCHIO	COVER	COUVERCLE	DECKEL	TAPA
21	075820BP	COPERCHIO	COVER	COUVERCLE	DECKEL	TAPA
21	075820C4	COVER	COVER	COUVERCLE	DECKEL	TAPA
21	075820CO	COPERCHIO	COVER	COUVERCLE	DECKEL	TAPA
21	075820DI	COPERCHIO	COVER	COUVERCLE	DECKEL	TAPA
21	075820EM	COVER	COVER	COUVERCLE	DECKEL	TAPA
21	075820EW	COPERCHIO	COVER	COUVERCLE	DECKEL	TAPA
21	075820GB	COVER	COVER	COUVERCLE	DECKEL	TAPA
21	075820J2	COVER	COVER	COUVERCLE	DECKEL	TAPA
22	075827A3	COPERCHIO	COVER	COUVERCLE	DECKEL	TAPA
22	075827A5	COPERCHIO	COVER	COUVERCLE	DECKEL	TAPA
22	075827A6	COPERCHIO	COVER	COUVERCLE	DECKEL	TAPA

Main color codes:  J1 - JLG Cream,  J2 - JLG Orange,  C4 - Green











 BASE TORRETTA TURRET BASE BASE TOURELLEARBEITSTURM BASE TORRETTA GIRATORIA 

POS	Codice	 Descrizione	 Description	 Designation	 Benennung	 Descripción
22	075827A7	COPERCHIO	COVER	COUVERCLE	DECKEL	TAPA
22	075827B9	COPERCHIO	COVER	COUVERCLE	DECKEL	TAPA
22	075827BP	COPERCHIO	COVER	COUVERCLE	DECKEL	TAPA
22	075827C4	COPERCHIO	COVER	COUVERCLE	DECKEL	TAPA
22	075827CO	COPERCHIO	COVER	COUVERCLE	DECKEL	TAPA
22	075827DI	COPERCHIO	COVER	COUVERCLE	DECKEL	TAPA
22	075827EM	COPERCHIO	COVER	COUVERCLE	DECKEL	TAPA
22	075827EW	COPERCHIO	COVER	COUVERCLE	DECKEL	TAPA
22	075827GB	COPERCHIO	COVER	COUVERCLE	DECKEL	TAPA
22	075827J2	COPERCHIO	COVER	COUVERCLE	DECKEL	TAPA
23	076006A3	COPERCHIO VANO SERBATOIO	COVER	COUVERCLE	DECKEL	TAPA
23	076006A5	COPERCHIO VANO SERBATOIO	COVER	COUVERCLE	DECKEL	TAPA
23	076006A6	COPERCHIO VANO SERBATOIO	COVER	COUVERCLE	DECKEL	TAPA
23	076006B9	COPERCHIO VANO SERBATOIO	COVER	COUVERCLE	DECKEL	TAPA
23	076006BP	COPERCHIO VANO SERBATOIO	COVER	COUVERCLE	DECKEL	TAPA
23	076006CO	COPERCHIO VANO SERBATOIO	COVER	COUVERCLE	DECKEL	TAPA
23	076006DI	COPERCHIO VANO SERBATOIO	COVER	COUVERCLE	DECKEL	TAPA
23	076006EM	COVER	COVER	COUVERCLE	DECKEL	TAPA
23	076006EW	COPERCHIO VANO SERBATOIO	COVER	COUVERCLE	DECKEL	TAPA
23	076006J2	COVER	COVER	COUVERCLE	DECKEL	TAPA
23	076083A7	COPERTURA	COVER	COUVERCLE	ABDECKUNG	TAPA
23	076083C4	COPERTURA	COVER	COUVERCLE	ABDECKUNG	TAPA
23	076083J2	COPERTURA	COVER	COUVERTURE	DECKUNG	COBERTURA
24	376015A3	SUPPORTO SERBATOIO	SUPPORT	SUPPORT	HALTERUNG	SOPORTE





Main color codes:  J1 - JLG Cream,  J2 - JLG Orange,  C4 - Green



 BASE TORRETTA TURRET BASE BASE TOURELLEARBEITSTURM BASE TORRETTA GIRATORIA 

POS	Codice	 Descrizione	 Description	 Designation	 Benennung	 Descripción
24	376015A5	SUPPORTO SERBATOIO	SUPPORT	SUPPORT	HALTERUNG	SOPORTE
24	376015A6	SUPPORTO SERBATOIO	SUPPORT	SUPPORT	HALTERUNG	SOPORTE
24	376015B9	SUPPORTO SERBATOIO	SUPPORT	SUPPORT	HALTERUNG	SOPORTE
24	376015BP	SUPPORTO SERBATOIO	SUPPORT	SUPPORT	HALTERUNG	SOPORTE
24	376015CO	SUPPORTO SERBATOIO	SUPPORT	SUPPORT	HALTERUNG	SOPORTE
24	376015DI	SUPPORTO SERBATOIO	SUPPORT	SUPPORT	HALTERUNG	SOPORTE
24	376015EM	SUPPORTO SERBATOIO	TANK SUPPORT	SUPPORT RESERVOIR	TANK HALTERUNG	SOPORTE DEPOSITO
24	376015EW	SUPPORTO SERBATOIO	SUPPORT	SUPPORT	HALTERUNG	SOPORTE
24	376015J2	SUPPORTO SERBATOIO	TANK SUPPORT	SUPPORT RESERVOIR	TANK HALTERUNG	SOPORTE DEPOSITO
24	376081A7	PORTAOGGETTI LL2614 LITIO SALDATO	GLOVE COMPARTMENT	BOÎTE À GANTS	HANDSCHUHFACH	GUANTERA
24	376081C4	PORTAOGGETTI LL2614 LITIO SALDATO	GLOVE COMPARTMENT	BOÎTE À GANTS	HANDSCHUHFACH	GUANTERA
24	376081J2	PORTAOGGETTI LL2614 LITIO	GLOVE COMPARTMENT LL2614 LITHIUM	BOÎTE À GANTS	HANDSCHUHFACH	GUANTERA
25	08273300	COPERCHIO FLANGIA ISPEZIONE SERBATOIO	TANK INSPECTION FLANGE COVER	COUVERCLE BRIDE RESERVOIR CARBURANT	FLANSCHABDECKUN G KRAFTSTOFFBEHÄLT ER	TAPA BRIDA DEPÓSITO COMBUSTIBLE
25	082733H2	COPERCHIO FLANGIA ISPEZIONE SERBATOIO	TANK INSPECTION FLANGE COVER	COUVERCLE	DECKEL HINOWA GREY	TAPA HINOWA GREY





Main color codes:  J1 - JLG Cream,  J2 - JLG Orange,  C4 - Green

 BASE TORRETTA TURRET BASE BASE TOURELLEARBEITSTURM BASE TORRETTA GIRATORIA 



POS	Codice	 Descrizione	 Description	 Designation	 Benennung	 Descripción
26	28298400	GUARNIZIONE	SEAL	JOINT OR	DICHTUNG OR	SELLO OR
27	174938H3	SERBATOIO GASOLIO	DIESEL TANK	RÉSERVOIR DE GASOIL	DIESELTANK	DEPÓSITO DE GASÓLEO
27	182215H2	SERBATOIO GASOLIO	FUEL TANK	RÉSERVOIR DIESEL HINOWA GREY	DIESELBEHÄLTER HINOWA GREY	TANQUE DE DISÉL
28	27600000	LIVELLO GASOLIO	DIESEL LEVEL	NIVEAU GASOIL	DIESEL STAND	NIVEL GASOIL
28	28110800	SENSORE DI LIVELLO GASOLIO	DIESEL LEVEL SENSOR	CAPTEUR DE NIVEAU DIESEL	DIESEL LEVEL SENSOR	NIVEL DIESEL
30	25731300	TAPPO	CAP	BOUCHON	VERSCHLUSS	TAPÓN
31	07599700	BOCCOLA	BUSH	DOUILLE	BUCHSE	CASQUILLO
33	07256800	BOCCOLA	BUSH	DOUILLE	BUCHSE	CASQUILLO
34	374932A3	SCATOLA MOTORE ELETTRICO	BOX	BOITE	GEHÄUSE	CAJA
34	374932A5	SCATOLA MOTORE ELETTRICO	BOX	BOITE	GEHÄUSE	CAJA
34	374932A6	SCATOLA MOTORE ELETTRICO	BOX	BOITE	GEHÄUSE	CAJA
34	374932A7	SCATOLA MOTORE ELETTRICO	BOX	BOITE	GEHÄUSE	CAJA
34	374932B9	SCATOLA MOTORE ELETTRICO	BOX	BOITE	GEHÄUSE	CAJA
34	374932BP	SCATOLA MOTORE ELETTRICO	BOX	BOITE	GEHÄUSE	CAJA
34	374932C4	SCATOLA MOTORE ELETTRICO	BOX	BOITE	GEHÄUSE	CAJA
34	374932CO	SCATOLA MOTORE ELETTRICO	BOX	BOITE	GEHÄUSE	CAJA
34	374932DI	SCATOLA MOTORE ELETTRICO	BOX	BOITE	GEHÄUSE	CAJA
34	374932EM	SCATOLA MOTORE ELETTRICO	BOX	BOITE	GEHÄUSE	CAJA
34	374932EW	SCATOLA MOTORE ELETTRICO	BOX	BOITE	GEHÄUSE	CAJA

Main color codes:  J1 - JLG Cream,  J2 - JLG Orange,  C4 - Green

 BASE TORRETTA TURRET BASE BASE TOURELLEARBEITSTURM BASE TORRETTA GIRATORIA 



POS	Codice	 Descrizione	 Description	 Designation	 Benennung	 Descripción
34	374932GB	SCATOLA MOTORE ELETTRICO	BOX	BOITE	GEHÄUSE	CAJA
34	374932J2	SCATOLA MOTORE ELETTRICO	BOX	BOITE	GEHÄUSE	CAJA
35	05656400	CHIAVE TAPPO DIESEL	KEY DIESEL CAP	CLÉ	SCHLÜSSEL	LLAVE

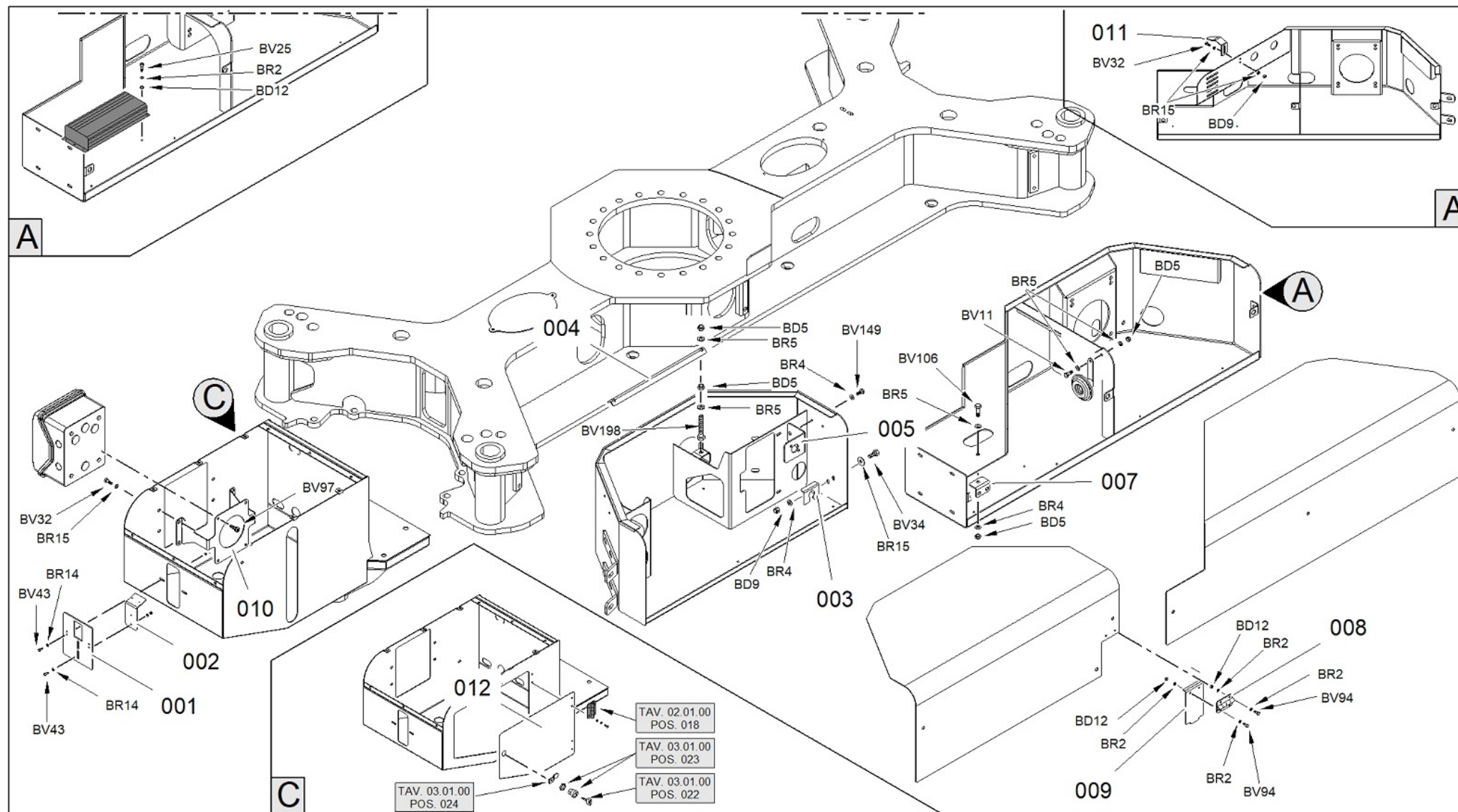

 BASE TORRETTA COMPONENTI ELETTRICI  
 CHASSIS ELECTRICAL COMPONENTS  
 COMPOSANTS ÉLECTRIQUES BASE FRAME

BASE FRAME ELECTRICAL COMPONENTS   
 FRAME BASE COMPONENTES ELÉCTRICOS 









Main color codes:  J1 - JLG Cream,  J2 - JLG Orange,  C4 - Green

 BASE TORRETTA COMPONENTI ELETTRICI

 CHASSIS ELECTRICAL COMPONENTS

 COMPOSANTS ÉLECTRIQUES BASE FRAME
BASE FRAME ELECTRICAL COMPONENTS FRAME BASE COMPONENTES ELÉCTRICOS 

POS	Codice	 Descrizione	 Description	 Designation	 Benennung	 Descripción
1	061187Y1	PIASTRA	PLATE	PLAQUE	PLATTE	PLACA
1	081262H2	PIATTO FISSAGGIO FOTOCPELLULE	PHOTOCELLS PLATE	PLAQUE FIXATION CELLULE PHOTO-ÉLECTRIQUE	BEFESTIGUNGSPLATT E PHOTOZELLE	PLACA FIJACIÓN FOTOCÉLULA
2	076071Y1	LAMIERA PIEGATA	FOLDED PLATE	TÔLE PLIÉE	BLECH	CHAPA DOBLADA
2	081128H2	PIASTRA FISSAGGIO FOTOCPELLULE	PHOTOCELL FIXING PLATE	PIÈCE DE FIXATION CELLULE PHOTO-ÉLECTRIQUE	BEFESTIGUNGSSTÜCK PHOTOZELLE	PIEZA DE FIJACIÓN FOTOCÉLULA
4	075822Y1	PIEGATO FISSAGGIO BATTERIA	FOLDED BATTERY FIXING	SUPPORT BATTERIE	BATTERIEHALTERUNG	SOPORTE BATERÍA
5	074167Y1	PIEGATO PER STACCABATTERIA MK2 (FROM C170000893)	SUPPORT FOR BATTERY CUTOFF MK2 (FROM C170000893)	SUPPORT POUR COUPE BATTERIE MK2 (FROM C170000893)	HALTERUNG FÜR BATTERIETRENNSCHALTER MK2 (FROM C170000893)	SOPORTE PARA DESCONECTADOR DE BATERÍA MK2 (FROM C170000893)
7	055629H3	STAFFA	BRACKET	ÉTRIER	HALTEBÜGEL	ESTRIBO
8	07178700	CERNIERA CON CONTROLLO DELLA POSIZIONE	HINGES WITH POSITION CONTROL	CHARNIÈRE	SCHARNIER	BISAGRA
9	075821A3	COPERCHIO	COVER	COUVERCLE	DECKEL	TAPA
9	075821A5	COPERCHIO	COVER	COUVERCLE	DECKEL	TAPA
9	075821A6	COPERCHIO	COVER	COUVERCLE	DECKEL	TAPA
9	075821A7	COPERCHIO	COVER	COUVERCLE	DECKEL	TAPA
9	075821B9	COPERCHIO	COVER	COUVERCLE	DECKEL	TAPA
9	075821BP	COPERCHIO	COVER	COUVERCLE	DECKEL	TAPA
9	075821C4	COPERCHIO	COVER	COUVERCLE	DECKEL	TAPA
9	075821CO	COPERCHIO	COVER	COUVERCLE	DECKEL	TAPA
9	075821DI	COPERCHIO	COVER	COUVERCLE	DECKEL	TAPA
9	075821EM	COPERCHIO	COVER	COUVERCLE	DECKEL	TAPA
9	075821EW	COPERCHIO	COVER	COUVERCLE	DECKEL	TAPA
9	075821GB	COPERCHIO	COVER	COUVERCLE	DECKEL	TAPA
9	075821J2	COPERCHIO	COVER	COUVERCLE	DECKEL	TAPA
10	076007Y1	SUPPORTO	SUPPORT	SUPPORT	HALTERUNG	SOPORTE





Main color codes:  J1 - JLG Cream,  J2 - JLG Orange,  C4 - Green





 BASE TORRETTA COMPONENTI ELETTRICI



 CHASSIS ELECTRICAL COMPONENTS



 COMPOSANTS ÉLECTRIQUES BASE FRAME
BASE FRAME ELECTRICAL COMPONENTS FRAME BASE COMPONENTES ELÉCTRICOS 

POS	Codice	 Descrizione	 Description	 Designation	 Benennung	 Descripción
11	076087D2	INDICE ALLINEAMENTO	ALIGNMENT INDICATOR	INDICATEUR D'ALIGNEMENT	AUSRICHTUNGSANZE IGE	INDICADOR ALINEACIÓN
12	076084A7	PORTELLO	HATCH	GUICHET	ABDECKPLATTE	PORTILLA
12	076084C4	PORTELLO	HATCH	GUICHET	ABDECKPLATTE	PORTILLA
12	076084J2	PORTELLO	HATCH	GUICHET	ABDECKPLATTE	PORTILLA



Main color codes:  J1 - JLG Cream,  J2 - JLG Orange,  C4 - Green

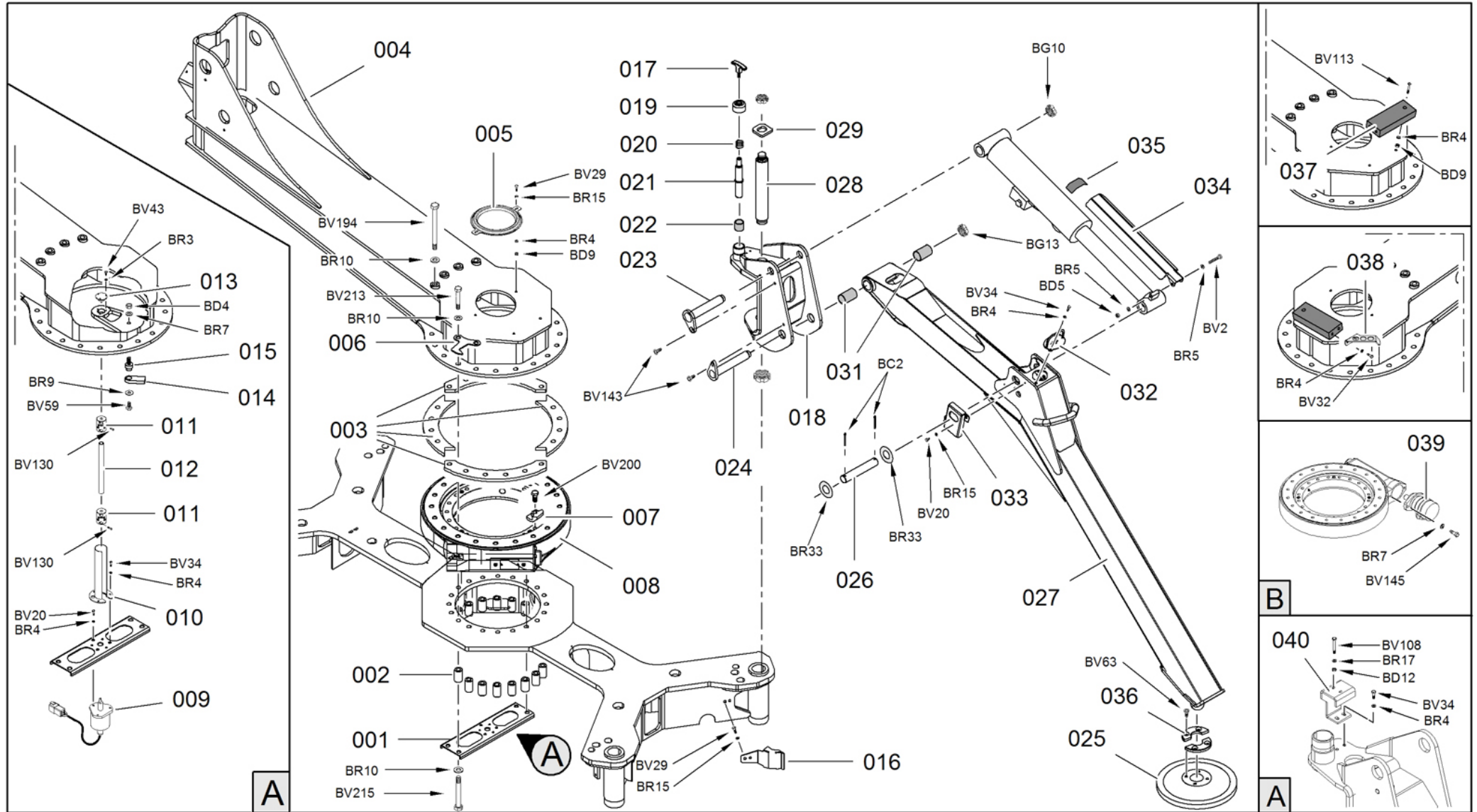

 SUPPORTO BRACCI  
 ARMS SUPPORT  
 SUPPORT BRAS

ARMEHALTERUNG   
 SOPORTE BRAZOS 











Main color codes:  J1 - JLG Cream,  J2 - JLG Orange,  C4 - Green

 SUPPORTO BRACCI

 ARMS SUPPORT

 SUPPORT BRAS
ARMEHALTERUNG SOPORTE BRAZOS 



POS	Codice	 Descrizione	 Description	 Designation	 Benennung	 Descripción
1	067463Y1	SUPPORTO	SUPPORT	SUPPORT	HALTERUNG	SOPORTE
2	06551600	PINZA	PLIERS	PINCE	KLEMME	PINZA
2	BR001000	RONDELLA X CARPENTERIA DIN 6916 HV 300 D 16 Z.BIANCA	CARPENTRY WASHER DIN 6916 HV 300 D 16 Z WHITE	RONDELLE POUR CHARPENTERIE DIN 6916 HV 300 D 16 Z.BLANCHE	ZIMMEREI UNTERLEGSCHIEBE DIN 6916 HV 300 D 16 Z WEIß	ARANDELA DE CARPINTERÍA DIN 6916 HV 300 D 16 GALVANIZADA BLANCA
2	BV005700	VITE TE PARZIALE FILETTO PG DIN 931 CL 10.9 M 16 X 220	SCREW PARTIAL THREAD DIN 931 PG CL 10.9 M 16 X 220	VIS PARTIELLEMENT FILETÉE DIN 931 CL 10.9 M 16 X 220	SCHRAUBE	TORNILLO
2	BV011000	VITE TE PARZIALE FILETTO PG DIN 931 CL 10.9 M 16 X 100	SCREW PARTIAL THREAD DIN 931 PG CL 10.9 M 16 X 100	VIS PARTIELLEMENT FILETÉE DIN 931 CL 10.9 M 16 X 100	SCHRAUBE	TORNILLO
2	BV011100	VITE TE PARZIALE FILETTO PG DIN 931 CL 10.9 M 16 X 105	SCREW PARTIAL THREAD DIN 931 PG CL 10.9 M 16 X 105	VIS PARTIELLEMENT FILETÉE DIN 931 CL 10.9 M 16 X 105	SCHRAUBE	TORNILLO
3	176090Y1	KIT 4 SPESSORI FISSAGGIO SUPPORTO BRACCI 15MM CATAFORESI	KIT 4 THICKNESSES FIXING SUPPORT ARMS 15MM	KIT 4 CALES	KIT VON 4 STÄRKEN	KIT 4 ESPESORES
4	374914A1	SUPPORTO BRACCI	SUPPORT MAIN BOOM	SUPPORT BRAS	HALTERUNG	SOPORTE BRAZOS
4	374914A5	SUPPORTO BRACCI	SUPPORT MAIN BOOM	BRAS DE SOUTIEN	TRAGARME	LOS BRAZOS DE SOPORTE
4	374914A6	SUPPORTO BRACCI	SUPPORT MAIN BOOM	BRAS DE SOUTIEN	TRAGARME	LOS BRAZOS DE SOPORTE
4	374914A7	SUPPORTO BRACCI	SUPPORT MAIN BOOM	BRAS DE SOUTIEN	TRAGARME	LOS BRAZOS DE SOPORTE
4	374914B9	SUPPORTO BRACCI	SUPPORT MAIN BOOM	BRAS DE SOUTIEN	TRAGARME	LOS BRAZOS DE SOPORTE
4	374914BP	SUPPORTO BRACCI	SUPPORT MAIN BOOM	BRAS DE SOUTIEN	TRAGARME	LOS BRAZOS DE SOPORTE
4	374914C4	SUPPORTO BRACCI	SUPPORT MAIN BOOM	BRAS DE SOUTIEN	TRAGARME	LOS BRAZOS DE SOPORTE



Main color codes:  J1 - JLG Cream,  J2 - JLG Orange,  C4 - Green

 SUPPORTO BRACCI





 ARMS SUPPORT



 SUPPORT BRAS
ARMEHALTERUNG SOPORTE BRAZOS 

POS	Codice	 Descrizione	 Description	 Designation	 Benennung	 Descripción
4	374914CO	SUPPORTO BRACCI	SUPPORT MAIN BOOM	BRAS DE SOUTIEN	TRAGARME	LOS BRAZOS DE SOPORTE
4	374914DI	SUPPORTO BRACCI	SUPPORT MAIN BOOM	BRAS DE SOUTIEN	TRAGARME	LOS BRAZOS DE SOPORTE
4	374914FX	SUPPORTO BRACCI	SUPPORT MAIN BOOM	BRAS DE SOUTIEN	TRAGARME	LOS BRAZOS DE SOPORTE
4	374914GB	SUPPORTO BRACCI	SUPPORT MAIN BOOM	BRAS DE SOUTIEN	TRAGARME	LOS BRAZOS DE SOPORTE
4	374914J1	SUPPORTO BRACCI	SUPPORT MAIN BOOM	SUPPORT BRAS	HALTERUNG	SOPORTE BRAZOS
5	069590H3	PROTEZIONE	PROTECTION	PROTECTION	SCHUTZ	PROTECCIÓN
6	076086D2	INDICATORE DI ALLINEAMENTO MOBILE	MOVABLE ALIGNMENT INDICATOR	AFFICHAGE DE L'ALIGNEMENT DE LA TELEPHONIE MOBILE	ALIGNMENT INDIKATOR MOBILE	ALINEACIÓN DE INDICADOR DE MÓVIL
7	076101Y1	FERMO	RETAINER	ARRÊT	HALTEVORRICHTUNG	BLOQUE
8	264593A3	RALLA	FIFTH WHEEL	COURONNE DENTÉE	DREHKRANZ	TEJUELO
8	264593H2	RALLA	FIFTH WHEEL	COURONNE DENTÉE	DREHKRANZ	TEJUELO
9	06680400	SENSORE	SENSOR	CAPTEUR	SENSOR	SENSOR
10	367460Y1	PROTEZIONE	PROTECTION	PROTECTION	SCHUTZ	PROTECCIÓN
11	26741500	GIUNTO	COUPLING	JOINT	VERBINDUNG	ACOPLAMIENTO
12	076089Y2	TUBO	PIPE	TUYAU	ROHR	TUBO
13	067464Y1	RISCONTRO	FASTENER LOCATOR	PLAQUE POUR AGRAFAGE	ANSCHLAG	GANCHO
14	064422Y1	FERMO	RETAINER	ARRÊT	HALTEVORRICHTUNG	BLOQUE
15	064423Y1	PERNO	PIN	GOIJON	ZAPFEN	PERNIO
16	076017A3	PROTEZIONE TUBI	PROTECTION	PROTECTION	SCHUTZ	PROTECCION
16	076017H2	PROTEZIONE TUBI	PROTECTION	PROTECTION	SCHUTZ	PROTECCION
17	06520700	MANIGLIA	HANDLE	POIGNÉE	GRIFF	MANIJA
18	174928A3	SNODO	ARTICULATION	ARTICULATION	GELENK	ARTICULACIÓN
18	174928H2	SNODO	ARTICULATION	ARTICULATION	GELENK	ARTICULACIÓN
19	07611300	COPERCHIO	COVER	COUVERCLE	DECKEL	TAPA
20	07599800	MOLLA	SPRING	RESSORT	FEDER	MUELLE
21	07585900	SPINA	PIN	CHEVILLE	STIFT	CLAVIJA

Main color codes:  J1 - JLG Cream,  J2 - JLG Orange,  C4 - Green

 SUPPORTO BRACCI ARMS SUPPORT SUPPORT BRASARMEHALTERUNG SOPORTE BRAZOS 





POS	Codice	 Descrizione	 Description	 Designation	 Benennung	 Descripcìon
22	07599600	BOCCOLA 25X30 L30 HSG	BUSH 25X30 L30 HSG	DOUILLE 25X30 L30 HSG	BUCHSE 25X30 L30 HSG	CASQUILLO 25X30 L30 HSG
23	07585600	SPINA	PIN	CHEVILLE	STIFT	CLAVIJA
24	07583000	SPINA	PIN	CHEVILLE	STIFT	CLAVIJA
25	05446300	DISCO	DISK	DISQUE	SCHEIBE	DISCO
26	07585800	SPINA	PIN	CHEVILLE	STIFT	CLAVIJA
27	174929A3	STABILIZZATORE COMPLETO	COMPLETE STABILIZER	STABILISATEUR COMPLET	STABILIZER KOMPLETT	ESTABILIZADOR COMPLETO
27	174929A5	STABILIZZATORE COMPLETO	COMPLETE STABILIZER	STABILISATEUR COMPLET	STABILIZER KOMPLETT	ESTABILIZADOR COMPLETO
27	174929A6	STABILIZZATORE COMPLETO	COMPLETE STABILIZER	STABILISATEUR COMPLET	STABILIZER KOMPLETT	ESTABILIZADOR COMPLETO
27	174929A7	STABILIZZATORE COMPLETO	COMPLETE STABILIZER	STABILISATEUR COMPLET	STABILIZER KOMPLETT	ESTABILIZADOR COMPLETO
27	174929B9	STABILIZZATORE COMPLETO	COMPLETE STABILIZER	STABILISATEUR COMPLET	STABILIZER KOMPLETT	ESTABILIZADOR COMPLETO
27	174929BP	STABILIZZATORE COMPLETO	COMPLETE STABILIZER	STABILISATEUR COMPLET	STABILIZER KOMPLETT	ESTABILIZADOR COMPLETO
27	174929C4	STABILIZZATORE COMPLETO	COMPLETE STABILIZER	STABILISATEUR COMPLET	STABILIZER KOMPLETT	ESTABILIZADOR COMPLETO
27	174929CO	STABILIZZATORE COMPLETO	COMPLETE STABILIZER	STABILISATEUR COMPLET	STABILIZER KOMPLETT	ESTABILIZADOR COMPLETO
27	174929DI	STABILIZZATORE COMPLETO	COMPLETE STABILIZER	STABILISATEUR COMPLET	STABILIZER KOMPLETT	ESTABILIZADOR COMPLETO
27	174929EM	STABILIZZATORE COMPLETO	COMPLETE STABILIZER	STABILISATEUR COMPLET	STABILIZER KOMPLETT	ESTABILIZADOR COMPLETO
27	174929EW	STABILIZZATORE COMPLETO	COMPLETE STABILIZER	STABILISATEUR COMPLET	STABILIZER KOMPLETT	ESTABILIZADOR COMPLETO
27	174929GB	STABILIZZATORE COMPLETO	COMPLETE STABILIZER	STABILISATEUR COMPLET	STABILIZER KOMPLETT	ESTABILIZADOR COMPLETO
27	174929J2	STABILIZZATORE COMPLETO	COMPLETE STABILIZER	STABILISATEUR COMPLET	STABILIZER KOMPLETT	ESTABILIZADOR COMPLETO
28	07582800	SPINA	PIN	CHEVILLE	STIFT	CLAVIJA



Main color codes:  J1 - JLG Cream,  J2 - JLG Orange,  C4 - Green

 SUPPORTO BRACCI

 ARMS SUPPORT

 SUPPORT BRAS
ARMEHALTERUNG SOPORTE BRAZOS 

POS	Codice	 Descrizione	 Description	 Designation	 Benennung	 Descripción
29	075829Y1	PIATTO FERMA SPINA AVVITATO	PIN FIXING PLATE	AXE FIXATION PLAQUE	PLATTE	PLACA
31	06422200	BOCCOLA	BUSH	DOUILLE	BUCHSE	CASQUILLO
32	376018A3	SUPPORTO SPIA STABILIZZATORE (FOR LL2010-X20JP- X600AJ MK2 FROM C170000893)	OUTRIGGER LIGHT SUPPORT (FOR LL2010-X20JP-X600AJ MK2 FROM C170000893)	SUPPORT LUMIÈRE STABILISATEUR (FOR LL2010-X20JP-X600AJ MK2 FROM C170000893)	LICHTHALTERUNG (FOR LL2010-X20JP- X600AJ MK2 FROM C170000893)	SOPORTE LUZ (FOR LL2010-X20JP-X600AJ MK2 FROM C170000893)
32	376018H2	SUPPORTO SPIA STABILIZZATORE (FOR LL2010-X20JP- X600AJ MK2 FROM C170000893)	OUTRIGGER LIGHT SUPPORT (FOR LL2010-X20JP-X600AJ MK2 FROM C170000893)	SUPPORT LUMIÈRE STABILISATEUR (FOR LL2010-X20JP-X600AJ MK2 FROM C170000893)	LICHTHALTERUNG (FOR LL2010-X20JP- X600AJ MK2 FROM C170000893)	SOPORTE LUZ (FOR LL2010-X20JP-X600AJ MK2 FROM C170000893)
33	075882A3	CARTER DI PROTEZIONE	PROTECTION COVER	PROTECTION	SCHUTZ	PROTECCIÓN
33	075882H2	CARTER DI PROTEZIONE	PROTECTION COVER - RIGHT	PROTECTION	SCHUTZ	PROTECCIÓN
33	077401A3	CARTER DI PROTEZIONE	PROTECTION COVER	CARTER DE PROTECTION	CARTER VON SCHUTZ	CARTER DE PROTECCIÓN
33	077401H2	CARTER DI PROTEZIONE	PROTECTION COVER - LEFT	CARTER DE PROTECTION	CARTER VON SCHUTZ	CARTER DE PROTECCIÓN
34	075883A3	CARTER DI PROTEZIONE	PROTECTION COVER	PROTECTION	SCHUTZ	PROTECCIÓN
34	075883H2	CARTER DI PROTEZIONE	PROTECTION COVER	PROTECTION	SCHUTZ	PROTECCIÓN
35	07894900	GOMMA ADESIVA DI PROTEZIONE L=70	RUBBER ADHESIVE PROTECTION L=70	GOMME ADHESIVE DE PROTECTION L=70	SCHUTZ- KLEBEGUMMI L=70	GOMA ADHESIVA DE PROTECCIÓN L=70
36	073147Y1	SEMIFLANGIA	HALF FLANGE	DEMI-BRIDE	HALB FLANSCH	SEMI BRIDA
37	07314000	TAMPONE APPOGGIO PRIMO BRACCIO	BUFFER SUPPORT FIRST ARM	TAMPON DE SUPPORT PREMIER BRAS	PUFFER ARMHALTERUNG	TAMPÓN PRIMER BRAZO
38	076078H3	SUPPORTO	SUPPORT	SUPPORT	HALTERUNG	SOPORTE
39	261308A3	MOTORE DI ROTAZIONE	ROTARY MOTOR	MOTEUR DE ROTATION	ROTATIONSMOTOR	MOTOR DE ROTACIÓN

Main color codes:  J1 - JLG Cream,  J2 - JLG Orange,  C4 - Green











 SUPPORTO BRACCI ARMS SUPPORT SUPPORT BRASARMEHALTERUNG SOPORTE BRAZOS 

POS	Codice	 Descrizione	 Description	 Designation	 Benennung	 Descripción
39	261308H2	MOTORE DI ROTAZIONE	ROTARY MOTOR	MOTEUR DE ROTATION	ROTATIONSMOTOR	MOTOR DE ROTACIÓN
40	076114A3	SUPPORTO	SUPPORT	SUPPORT	HALTERUNG	SOPORTE
40	076114H2	SUPPORTO	SUPPORT	SUPPORT	HALTERUNG	SOPORTE





 PRIMO BRACCIO FIRST ARM PREMIER BRASERSTER AUSLEGERARM PRIMO BRAZO 

POS	Codice	 Descrizione	 Description	 Designation	 Benennung	 Descripción
1	05849000	PATTINO	SLIDE BLOCK	PATIN	GLEITBLOCK	PATÍN
2	07562700	SPINA	PIN	CHEVILLE	STIFT	CLAVIJA
3	07562800	SPINA	PIN	CHEVILLE	STIFT	CLAVIJA
4	07563300	SPINA	PIN	CHEVILLE	STIFT	CLAVIJA
5	174916A1	TIRANTE	TIE ROD	TIRANT	ZUGSTANGE	TIRANTE
5	174916A5	TIRANTE	TIE ROD	TIRANT	TURMGESTÄNGE	TIRANTE
5	174916A6	TIRANTE	TIE ROD	TIRANT	TURMGESTÄNGE	TIRANTE
5	174916A7	TIRANTE	TIE ROD	TIRANT	TURMGESTÄNGE	TIRANTE
5	174916B9	TIRANTE	TIE ROD	TIRANT	TURMGESTÄNGE	TIRANTE
5	174916BP	TIRANTE	TIE ROD	TIRANT	TURMGESTÄNGE	TIRANTE
5	174916C4	TIRANTE	TIE ROD	TIRANT	TURMGESTÄNGE	TIRANTE
5	174916CO	TIRANTE	TIE ROD	TIRANT	TURMGESTÄNGE	TIRANTE
5	174916DI	TIRANTE	TIE ROD	TIRANT	TURMGESTÄNGE	TIRANTE
5	174916FX	TIRANTE	TIE ROD	TIRANT	TURMGESTÄNGE	TIRANTE
5	174916GB	TIRANTE	TIE ROD	TIRANT	TURMGESTÄNGE	TIRANTE
5	174916J1	TIRANTE	TIE ROD	TIRANT	ZUGSTANGE	TIRANTE
6	07563900	BOCCOLA 60X65 L40 HSG	BUSH 60X65 L40 HSG	BAGUE	BUCHSE	CASQUILLO
7	07262200	BOCCOLA	BUSH	DOUILLE	BUCHSE	CASQUILLO
8	174915A1	PRIMO BRACCIO	FIRST ARM	PREMIER BRAS	ERSTER AUSLEGERARM	PRIMO BRAZO
8	174915A5	PRIMO BRACCIO	FIRST ARM	PREMIER BRAS	ERSTER AUSLEGERARM	PRIMO BRAZO
8	174915A6	PRIMO BRACCIO	FIRST ARM	PREMIER BRAS	ERSTER AUSLEGERARM	PRIMO BRAZO
8	174915A7	PRIMO BRACCIO	FIRST ARM	PREMIER BRAS	ERSTER AUSLEGERARM	PRIMO BRAZO
8	174915B9	PRIMO BRACCIO	FIRST ARM	PREMIER BRAS	ERSTER AUSLEGERARM	PRIMO BRAZO
8	174915BP	PRIMO BRACCIO	FIRST ARM	PREMIER BRAS	ERSTER AUSLEGERARM	PRIMO BRAZO
8	174915C4	PRIMO BRACCIO	FIRST ARM	PREMIER BRAS	ERSTER AUSLEGERARM	PRIMO BRAZO

Main color codes:  J1 - JLG Cream,  J2 - JLG Orange,  C4 - Green

 PRIMO BRACCIO FIRST ARM PREMIER BRASERSTER AUSLEGERARM PRIMO BRAZO 

POS	Codice	 Descrizione	 Description	 Designation	 Benennung	 Descripción
8	174915CO	PRIMO BRACCIO	FIRST ARM	PREMIER BRAS	ERSTER AUSLEGERARM	PRIMO BRAZO
8	174915DI	PRIMO BRACCIO	FIRST ARM	PREMIER BRAS	ERSTER AUSLEGERARM	PRIMO BRAZO
8	174915FX	PRIMO BRACCIO	FIRST ARM	PREMIER BRAS	ERSTER AUSLEGERARM	PRIMO BRAZO
8	174915GB	PRIMO BRACCIO	FIRST ARM	PREMIER BRAS	ERSTER AUSLEGERARM	PRIMO BRAZO
8	174915J1	PRIMO BRACCIO	FIRST ARM	PREMIER BRAS	ERSTER AUSLEGERARM	PRIMO BRAZO
9	07563800	BOCCOLA 50X55 L=40 HSG	BUSH 50X55 L=40 HSG	BAGUE	BUCHSE	CASQUILLO
10	174917A1	BIELLA PRIMO-SECONDO BRACCIO COMPLETA	TIEROD FIRST-SECOND BOOMS	BIELLE PREMIER DEUXIÈME BRAS COMPLET	PLEUELSTANGE ERSTER ZWEITER ARM	BARRA DE PRIMER SEGUNDO BRAZO
10	174917A5	BIELLA PRIMO-SECONDO BRACCIO COMPLETA	TIEROD FIRST-SECOND BOOMS	ROD PREMIERS DEUXIÈME BRAS COMPLET	ROD ERSTE ZWEITE-VOLL ARM	BARRA DE PRIMER SEGUNDO BRAZO COMPLETO
10	174917A6	BIELLA PRIMO-SECONDO BRACCIO COMPLETA	TIEROD FIRST-SECOND BOOMS	ROD PREMIERS DEUXIÈME BRAS COMPLET	ROD ERSTE ZWEITE-VOLL ARM	BARRA DE PRIMER SEGUNDO BRAZO COMPLETO
10	174917A7	BIELLA PRIMO-SECONDO BRACCIO COMPLETA	TIEROD FIRST-SECOND BOOMS	ROD PREMIERS DEUXIÈME BRAS COMPLET	ROD ERSTE ZWEITE-VOLL ARM	BARRA DE PRIMER SEGUNDO BRAZO COMPLETO
10	174917B9	BIELLA PRIMO-SECONDO BRACCIO COMPLETA	TIEROD FIRST-SECOND BOOMS	ROD PREMIERS DEUXIÈME BRAS COMPLET	ROD ERSTE ZWEITE-VOLL ARM	BARRA DE PRIMER SEGUNDO BRAZO COMPLETO
10	174917BP	BIELLA PRIMO-SECONDO BRACCIO COMPLETA	TIEROD FIRST-SECOND BOOMS	ROD PREMIERS DEUXIÈME BRAS COMPLET	ROD ERSTE ZWEITE-VOLL ARM	BARRA DE PRIMER SEGUNDO BRAZO COMPLETO
10	174917C4	BIELLA PRIMO-SECONDO BRACCIO COMPLETA	TIEROD FIRST-SECOND BOOMS	ROD PREMIERS DEUXIÈME BRAS COMPLET	ROD ERSTE ZWEITE-VOLL ARM	BARRA DE PRIMER SEGUNDO BRAZO COMPLETO



Main color codes:  J1 - JLG Cream,  J2 - JLG Orange,  C4 - Green

 PRIMO BRACCIO

 FIRST ARM

 PREMIER BRAS
ERSTER AUSLEGERARM PRIMO BRAZO 

POS	Codice	 Descrizione	 Description	 Designation	 Benennung	 Descripción
10	174917CO	BIELLA PRIMO- SECONDO BRACCIO COMPLETA	TIEROD FIRST- SECOND BOOMS	ROD PREMIERS DEUXIÈME BRAS COMPLET	ROD ERSTE ZWEITE- VOLL ARM	BARRA DE PRIMER SEGUNDO BRAZO COMPLETO
10	174917DI	BIELLA PRIMO- SECONDO BRACCIO COMPLETA	TIEROD FIRST- SECOND BOOMS	ROD PREMIERS DEUXIÈME BRAS COMPLET	ROD ERSTE ZWEITE- VOLL ARM	BARRA DE PRIMER SEGUNDO BRAZO COMPLETO
10	174917FX	BIELLA PRIMO- SECONDO BRACCIO COMPLETA	TIEROD FIRST- SECOND BOOMS	ROD PREMIERS DEUXIÈME BRAS COMPLET	ROD ERSTE ZWEITE- VOLL ARM	BARRA DE PRIMER SEGUNDO BRAZO COMPLETO
10	174917GB	BIELLA PRIMO- SECONDO BRACCIO COMPLETA	TIEROD FIRST- SECOND BOOMS	ROD PREMIERS DEUXIÈME BRAS COMPLET	ROD ERSTE ZWEITE- VOLL ARM	BARRA DE PRIMER SEGUNDO BRAZO COMPLETO
10	174917J1	BIELLA PRIMO- SECONDO BRACCIO COMPLETA	TIEROD FIRST- SECOND BOOMS	BIELLE PREMIER DEUXIÈME BRAS COMPLET	PLEUELSTANGE ERSTER ZWEITER ARM	BARRA DE PRIMER SEGUNDO BRAZO
11	374918A1	RINVIO 1°-2° BRACCIO	CONNECTION ROD 1ST-2ND BOOM	RENOI 1ER -2ÈME BRAS	VORGELEGE 1. -2. ARM	REENVIO 1 ° -2 ° BRAZO
11	374918A5	RINVIO 1°-2° BRACCIO	UPRIGHT 1ST-2ND BOOMS	REFERENCE 1 ° -2 ° ARM	REFERENCE 1 ° -2 ° ARM	REFERENCIA 1 ° -2 ° ARM
11	374918A6	RINVIO 1°-2° BRACCIO	UPRIGHT 1ST-2ND BOOMS	REFERENCE 1 ° -2 ° ARM	REFERENCE 1 ° -2 ° ARM	REFERENCIA 1 ° -2 ° ARM
11	374918A7	RINVIO 1°-2° BRACCIO	UPRIGHT 1ST-2ND BOOMS	REFERENCE 1 ° -2 ° ARM	REFERENCE 1 ° -2 ° ARM	REFERENCIA 1 ° -2 ° ARM
11	374918B9	RINVIO 1°-2° BRACCIO	UPRIGHT 1ST-2ND BOOMS	REFERENCE 1 ° -2 ° ARM	REFERENCE 1 ° -2 ° ARM	REFERENCIA 1 ° -2 ° ARM
11	374918BP	RINVIO 1°-2° BRACCIO	UPRIGHT 1ST-2ND BOOMS	REFERENCE 1 ° -2 ° ARM	REFERENCE 1 ° -2 ° ARM	REFERENCIA 1 ° -2 ° ARM
11	374918C4	RINVIO 1°-2° BRACCIO	UPRIGHT 1ST-2ND BOOMS	REFERENCE 1 ° -2 ° ARM	REFERENCE 1 ° -2 ° ARM	REFERENCIA 1 ° -2 ° ARM
11	374918CO	RINVIO 1°-2° BRACCIO	UPRIGHT 1ST-2ND BOOMS	REFERENCE 1 ° -2 ° ARM	REFERENCE 1 ° -2 ° ARM	REFERENCIA 1 ° -2 ° ARM
11	374918DI	RINVIO 1°-2° BRACCIO	UPRIGHT 1ST-2ND BOOMS	REFERENCE 1 ° -2 ° ARM	REFERENCE 1 ° -2 ° ARM	REFERENCIA 1 ° -2 ° ARM



Main color codes:  J1 - JLG Cream,  J2 - JLG Orange,  C4 - Green

 PRIMO BRACCIO

 FIRST ARM

 PREMIER BRAS
ERSTER AUSLEGERARM PRIMO BRAZO 

POS	Codice	 Descrizione	 Description	 Designation	 Benennung	 Descripción
11	374918FX	RINVIO 1°-2° BRACCIO	UPRIGHT 1ST-2ND BOOMS	REFERENCE 1 ° -2 ° ARM	REFERENCE 1 ° -2 ° ARM	REFERENCIA 1 ° -2 ° ARM
11	374918GB	RINVIO 1°-2° BRACCIO	UPRIGHT 1ST-2ND BOOMS	REFERENCE 1 ° -2 ° ARM	REFERENCE 1 ° -2 ° ARM	REFERENCIA 1 ° -2 ° ARM
11	374918J1	RINVIO 1°-2° BRACCIO	CONNECTION ROD 1ST-2ND BOOM	RENOI 1ER -2ÉME BRAS	VORGELEGE 1. -2. ARM	REENVIO 1 ° -2 ° BRAZO
12	07563100	SPINA	PIN	CHEVILLE	STIFT	CLAVIJA
13	07563200	GOCCIA SPINA	PIN DROP	BAISSE CHEVILLE	TROPFEN STIFT	CAÍDA CLAVIJA
14	07563700	SPINA	PIN	CHEVILLE	STIFT	CLAVIJA
16	058832H3	SUPPORTO	SUPPORT	SUPPORT	HALTERUNG	SOPORTE
17	05427200	LIVELLA	LEVEL	NIVEAU	WASSERWAAGE	NIVEL DE BURBUJA
18	05444800	MOLLA	SPRING	RESSORT	FEDER	MUELLE
19	075885A3	STAFFA ANTERIORE SUPPORTO DISTRIBUTORE	FRONT BRACKET MOUNT DISTRIBUTOR	ÉTRIER	HALTEBÜGEL	ESTRIBO
19	075885H2	STAFFA ANTERIORE SUPPORTO DISTRIBUTORE	FRONT BRACKET MOUNT DISTRIBUTOR	ÉTRIER	HALTEBÜGEL	ESTRIBO
20	075884A3	SUPPORTO	SUPPORT	SUPPORT	HALTERUNG	SOPORTE
20	075884H2	SUPPORTO	SUPPORT	SUPPORT	HALTERUNG	SOPORTE
21	075886A3	STAFFA POSTERIORE SUPPORTO DISTRIBUTORE	REAR BRACKET MOUNT DISTRIBUTOR	ÉTRIER	HALTEBÜGEL	ESTRIBO
21	075886H2	STAFFA POSTERIORE SUPPORTO DISTRIBUTORE	REAR BRACKET MOUNT DISTRIBUTOR	ÉTRIER	HALTEBÜGEL	ESTRIBO
22	07298800	CHIAVE PER SERRATURA POSTAZIONE COMANDO A TERRA	KEY TO THE LOCK ON THE GROUND CONTROL POSITION	CLÉ	SCHLÜSSEL	LLAVE
23	07178800	SERRATURA	LOCK	SERRURE	SCHLOSS	CERRADURA
24	07178900	CAMMA PER SERRATURA DISASSAMENTO 3.2	CAM LOCK FOR OFFSET 3.2	CAME	NOCKEN	LEVA





Main color codes:  J1 - JLG Cream,  J2 - JLG Orange,  C4 - Green





 PRIMO BRACCIO



 FIRST ARM

 PREMIER BRAS
ERSTER AUSLEGERARM PRIMO BRAZO 



POS	Codice	 Descrizione	 Description	 Designation	 Benennung	 Descripción
26	073144A3	COPERCHIO (FOR LL1775-X17JP-X500AJ MK2 FROM C170000893)	COVER (FOR LL1775-X17JP-X500AJ MK2 FROM C170000893)	COUVERTURE (FOR LL1775-X17JP-X500AJ MK2 FROM C170000893)	ABDECKUNG (FOR LL1775-X17JP-X500AJ MK2 FROM C170000893)	CUBIERTA (FOR LL1775-X17JP-X500AJ MK2 FROM C170000893)
26	073144H2	COPERCHIO (FOR LL1775-X17JP-X500AJ MK2 FROM C170000893)	COVER (FOR LL1775-X17JP-X500AJ MK2 FROM C170000893)	COUVERTURE (FOR LL1775-X17JP-X500AJ MK2 FROM C170000893)	DECKUNG (FOR LL1775-X17JP-X500AJ MK2 FROM C170000893)	COBERTURA (FOR LL1775-X17JP-X500AJ MK2 FROM C170000893)
26	075059H2	COPERCHIO SENZA CHIAVE VERSIONE ANSI (FOR LL1775-X17JP-X500AJ MK2 FROM C170000893)	COVER WITHOUT KEY ANSI VERSION (FOR LL1775-X17JP-X500AJ MK2 FROM C170000893)	COUVERTURE SANS CLÉ (FOR LL1775-X17JP-X500AJ MK2 FROM C170000893)	DECKUNG OHNE SCHLÜSSEL (FOR LL1775-X17JP-X500AJ MK2 FROM C170000893)	COBERTURA SIN LLAVE (FOR LL1775-X17JP-X500AJ MK2 FROM C170000893)
27	073138Y1	SUPPORTO SERRATURA	LOCK SUPPORT	SUPPORT SERRURE	SCHLOSSHALTERUNG	SOPORTE CERRADURA
28	373142A3	CARTER DISTRIBUTORE BRACCI (FOR LL1775-X17JP-X500AJ MK2 FROM C170000893)	CARTER BOOM HYDRAULIC DISTRIBUTOR (FOR LL1775-X17JP-X500AJ MK2 FROM C170000893)	CARTER DISTRIBUTEUR (FOR LL1775-X17JP-X500AJ MK2 FROM C170000893)	CARTER HÄNDLER (FOR LL1775-X17JP-X500AJ MK2 FROM C170000893)	CARTER DISTRIBUIDOR (FOR LL1775-X17JP-X500AJ MK2 FROM C170000893)
28	373142H2	CARTER DISTRIBUTORE BRACCI (FOR LL1775-X17JP-X500AJ MK2 FROM C170000893)	PROTECTION BOOM HYDRAULIC DISTRIBUTOR (FOR LL1775-X17JP-X500AJ MK2 FROM C170000893)	PROTECTION DISTRIBUTEUR (FOR LL1775-X17JP-X500AJ MK2 FROM C170000893)	SCHUTZ VENTILBLOCK (FOR LL1775-X17JP-X500AJ MK2 FROM C170000893)	PROTECCION DISTRIBUIDOR (FOR LL1775-X17JP-X500AJ MK2 FROM C170000893)
29	06477600	MAGNETE Ø20 CON FORO M3	MAGNETO Ø20 WITH M3 HOLE	AIMANT	MAGNET	IMÁN





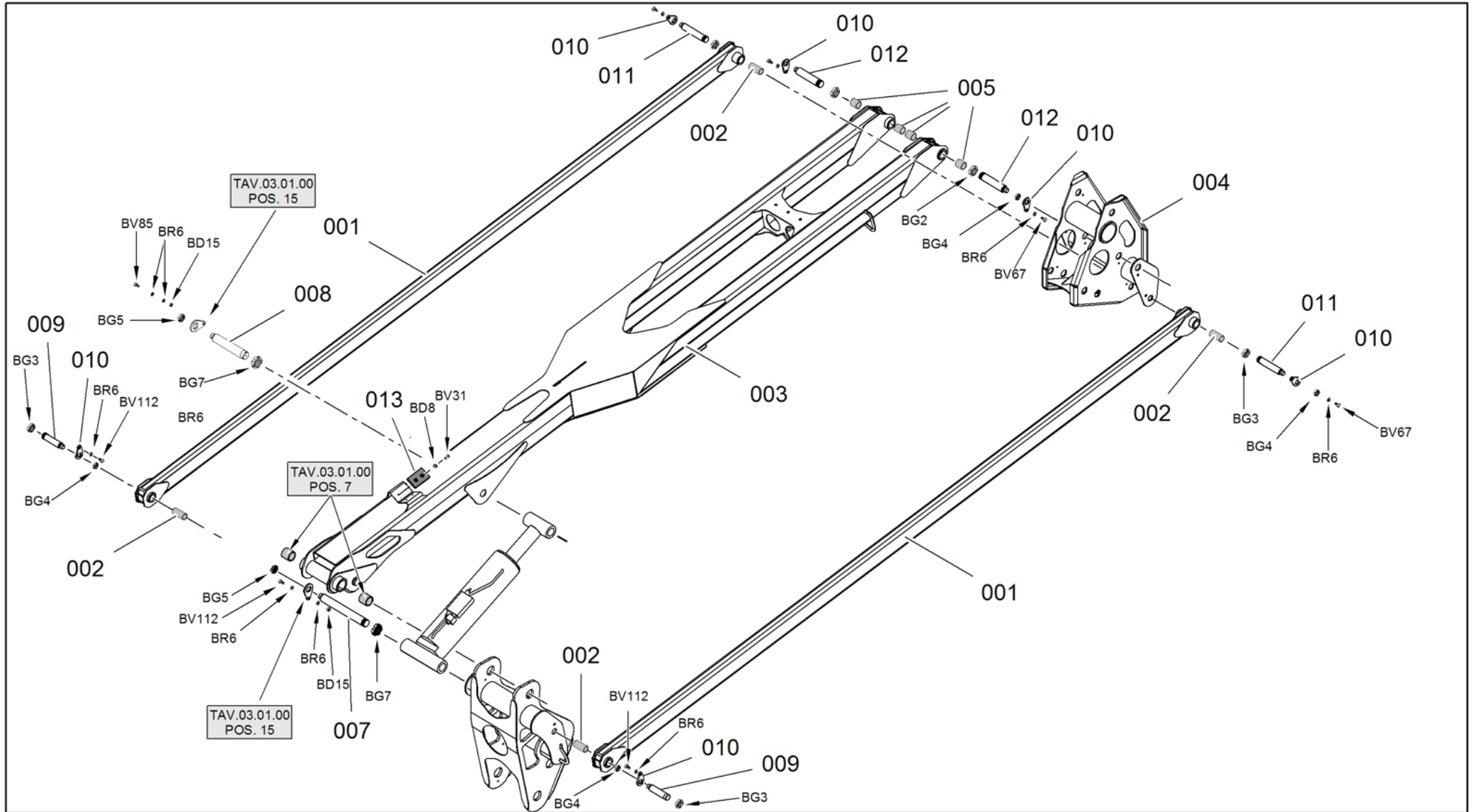

-  SECONDO BRACCIO
-  SECOND ARM
-  ZWEITER AUSLEGERARM





- SECOND BRAS 
- TWEEDE ARM 









Main color codes:  J1 - JLG Cream,  J2 - JLG Orange,  C4 - Green



 SECONDO BRACCIO  
 SECOND ARM  
 ZWEITER AUSLEGERARM





SECOND BRAS   
 TWEEDE ARM 



POS	Codice	 Descrizione	 Description	 Designation	 Benennung	 Descripción
1	174921A1	TIRANTE SECONDO BRACCIO COMPLETO	TIE ROD SECOND BOOM	TIRANT DEUXIÈME BRAS	ZUGSTANGE ZWEITER ARM	TIRANTE SECONDO BRAZO
1	174921A5	TIRANTE SECONDO BRACCIO COMPLETO	TIE ROD SECOND BOOM	TIE DEUXIÈME ARM SOLD OUT	TIE ZWEITE ARM AUSVERKAUFT	TIE SEGUNDO ARM TERMINADO
1	174921A6	TIRANTE SECONDO BRACCIO COMPLETO	TIE ROD SECOND BOOM	TIE DEUXIÈME ARM SOLD OUT	TIE ZWEITE ARM AUSVERKAUFT	TIE SEGUNDO ARM TERMINADO
1	174921A7	TIRANTE SECONDO BRACCIO COMPLETO	TIE ROD SECOND BOOM	TIE DEUXIÈME ARM SOLD OUT	TIE ZWEITE ARM AUSVERKAUFT	TIE SEGUNDO ARM TERMINADO
1	174921B9	TIRANTE SECONDO BRACCIO COMPLETO	TIE ROD SECOND BOOM	TIE DEUXIÈME ARM SOLD OUT	TIE ZWEITE ARM AUSVERKAUFT	TIE SEGUNDO ARM TERMINADO
1	174921BP	TIRANTE SECONDO BRACCIO COMPLETO	TIE ROD SECOND BOOM	TIE DEUXIÈME ARM SOLD OUT	TIE ZWEITE ARM AUSVERKAUFT	TIE SEGUNDO ARM TERMINADO
1	174921C4	TIRANTE SECONDO BRACCIO COMPLETO	TIE ROD SECOND BOOM	TIE DEUXIÈME ARM SOLD OUT	TIE ZWEITE ARM AUSVERKAUFT	TIE SEGUNDO ARM TERMINADO
1	174921CO	TIRANTE SECONDO BRACCIO COMPLETO	TIE ROD SECOND BOOM	TIE DEUXIÈME ARM SOLD OUT	TIE ZWEITE ARM AUSVERKAUFT	TIE SEGUNDO ARM TERMINADO
1	174921DI	TIRANTE SECONDO BRACCIO COMPLETO	TIE ROD SECOND BOOM	TIE DEUXIÈME ARM SOLD OUT	TIE ZWEITE ARM AUSVERKAUFT	TIE SEGUNDO ARM TERMINADO
1	174921FX	TIRANTE SECONDO BRACCIO COMPLETO	TIE ROD SECOND BOOM	TIE DEUXIÈME ARM SOLD OUT	TIE ZWEITE ARM AUSVERKAUFT	TIE SEGUNDO ARM TERMINADO
1	174921GB	TIRANTE SECONDO BRACCIO COMPLETO	TIE ROD SECOND BOOM	TIE DEUXIÈME ARM SOLD OUT	TIE ZWEITE ARM AUSVERKAUFT	TIE SEGUNDO ARM TERMINADO
1	174921J1	TIRANTE SECONDO BRACCIO COMPLETO	TIE ROD SECOND BOOM	TIRANT DEUXIÈME BRAS	ZUGSTANGE ZWEITER ARM	TIRANTE SECONDO BRAZO
2	06422200	BOCCOLA	BUSH	DOUILLE	BUCHSE	CASQUILLO
3	174920A1	SECONDO BRACCIO COMPLETO	SECOND BOOM	DEUXIÈME BRAS	ZWEITER ARM	SEGUNDO BRAZO
3	174920A5	SECONDO BRACCIO COMPLETO	SECOND BOOM	ARM DEUXIÈME COMPLETE	ARM COMPLETE SECOND	ARM SEGUNDO COMPLETO
3	174920A6	SECONDO BRACCIO COMPLETO	SECOND BOOM	ARM DEUXIÈME COMPLETE	ARM COMPLETE SECOND	ARM SEGUNDO COMPLETO
3	174920A7	SECONDO BRACCIO COMPLETO	SECOND BOOM	ARM DEUXIÈME COMPLETE	ARM COMPLETE SECOND	ARM SEGUNDO COMPLETO



Main color codes:  J1 - JLG Cream,  J2 - JLG Orange,  C4 - Green



 SECONDO BRACCIO  
 SECOND ARM  
 ZWEITER AUSLEGERARM





SECOND BRAS   
 TWEEDE ARM 



POS	Codice	 Descrizione	 Description	 Designation	 Benennung	 Descripción
3	174920B9	SECONDO BRACCIO COMPLETO	SECOND BOOM	ARM DEUXIÈME COMPLETE	ARM COMPLETE SECOND	ARM SEGUNDO COMPLETO
3	174920BP	SECONDO BRACCIO COMPLETO	SECOND BOOM	ARM DEUXIÈME COMPLETE	ARM COMPLETE SECOND	ARM SEGUNDO COMPLETO
3	174920C4	SECONDO BRACCIO COMPLETO	SECOND BOOM	ARM DEUXIÈME COMPLETE	ARM COMPLETE SECOND	ARM SEGUNDO COMPLETO
3	174920CO	SECONDO BRACCIO COMPLETO	SECOND BOOM	ARM DEUXIÈME COMPLETE	ARM COMPLETE SECOND	ARM SEGUNDO COMPLETO
3	174920DI	SECONDO BRACCIO COMPLETO	SECOND BOOM	ARM DEUXIÈME COMPLETE	ARM COMPLETE SECOND	ARM SEGUNDO COMPLETO
3	174920FX	SECONDO BRACCIO COMPLETO	SECOND BOOM	ARM DEUXIÈME COMPLETE	ARM COMPLETE SECOND	ARM SEGUNDO COMPLETO
3	174920GB	SECONDO BRACCIO COMPLETO	SECOND BOOM	ARM DEUXIÈME COMPLETE	ARM COMPLETE SECOND	ARM SEGUNDO COMPLETO
3	174920J1	SECONDO BRACCIO COMPLETO	SECOND BOOM	DEUXIÈME BRAS	ZWEITER ARM	SEGUNDO BRAZO
4	374922A1	RINVIO 2°-3° BRACCIO	CONNECTION ROD 2ND-3RD BOOMS	RENOI 2ME-3ME BRAS	VORGELEGE 2.-3. ARM	REENVIO 2 ° -3 ° BRAZO
4	374922A5	RINVIO 2°-3° BRACCIO	UPRIGHT 2ND-3RD BOOMS	REFERENCE 2 ° -3 ° ARM	REFERENZ 2 ° -3 ° ARM	REFERENCIA 2 ° -3 ° ARM
4	374922A6	RINVIO 2°-3° BRACCIO	UPRIGHT 2ND-3RD BOOMS	REFERENCE 2 ° -3 ° ARM	REFERENZ 2 ° -3 ° ARM	REFERENCIA 2 ° -3 ° ARM
4	374922A7	RINVIO 2°-3° BRACCIO	UPRIGHT 2ND-3RD BOOMS	REFERENCE 2 ° -3 ° ARM	REFERENZ 2 ° -3 ° ARM	REFERENCIA 2 ° -3 ° ARM
4	374922B9	RINVIO 2°-3° BRACCIO	UPRIGHT 2ND-3RD BOOMS	REFERENCE 2 ° -3 ° ARM	REFERENZ 2 ° -3 ° ARM	REFERENCIA 2 ° -3 ° ARM
4	374922BP	RINVIO 2°-3° BRACCIO	UPRIGHT 2ND-3RD BOOMS	REFERENCE 2 ° -3 ° ARM	REFERENZ 2 ° -3 ° ARM	REFERENCIA 2 ° -3 ° ARM
4	374922C4	RINVIO 2°-3° BRACCIO	UPRIGHT 2ND-3RD BOOMS	REFERENCE 2 ° -3 ° ARM	REFERENZ 2 ° -3 ° ARM	REFERENCIA 2 ° -3 ° ARM
4	374922CO	RINVIO 2°-3° BRACCIO	UPRIGHT 2ND-3RD BOOMS	REFERENCE 2 ° -3 ° ARM	REFERENZ 2 ° -3 ° ARM	REFERENCIA 2 ° -3 ° ARM
4	374922DI	RINVIO 2°-3° BRACCIO	UPRIGHT 2ND-3RD BOOMS	REFERENCE 2 ° -3 ° ARM	REFERENZ 2 ° -3 ° ARM	REFERENCIA 2 ° -3 ° ARM



Main color codes:  J1 - JLG Cream,  J2 - JLG Orange,  C4 - Green



 SECONDO BRACCIO  
 SECOND ARM  
 ZWEITER AUSLEGERARM

SECOND BRAS   
 TWEEDE ARM 



POS	Codice	 Descrizione	 Description	 Designation	 Benennung	 Descripción
4	374922FX	RINVIO 2°-3° BRACCIO	UPRIGHT 2ND-3RD BOOMS	REFERENCE 2 ° -3 ° ARM	REFERENZ 2 ° -3 ° ARM	REFERENCIA 2 ° -3 ° ARM
4	374922GB	RINVIO 2°-3° BRACCIO	UPRIGHT 2ND-3RD BOOMS	REFERENCE 2 ° -3 ° ARM	REFERENZ 2 ° -3 ° ARM	REFERENCIA 2 ° -3 ° ARM
4	374922J1	RINVIO 2°-3° BRACCIO	CONNECTION ROD 2ND-3RD BOOMS	RENOI 2ME-3ME BRAS	VORGELEGE 2.-3. ARM	REENVIO 2 ° -3 ° BRAZO
5	07130500	BOCCOLA 404540	BUSH	DOUILLE	BUCHSE	CASQUILLO
7	07563500	SPINA	PIN	CHEVILLE	STIFT	CLAVIJA
8	07607900	SPINA	PIN	CHEVILLE	STIFT	CLAVIJA
9	07563600	SPINA	PIN	CHEVILLE	STIFT	CLAVIJA
11	07539700	SPINA	PIN	AXE	STIFT	CLAVIJA
12	07520600	SPINA	PIN	AXE	STIFT	CLAVIJA
13	07314500	TAMPONE APPOGGIO TERZO BRACCIO	THIRD ARM PAD SUPPORT	TAMPON	PUFFER	TAMPÓN

Main color codes:  J1 - JLG Cream,  J2 - JLG Orange,  C4 - Green

 TERZO BRACCIO  
 THIRD ARM  
 TROISIÈME BRAS

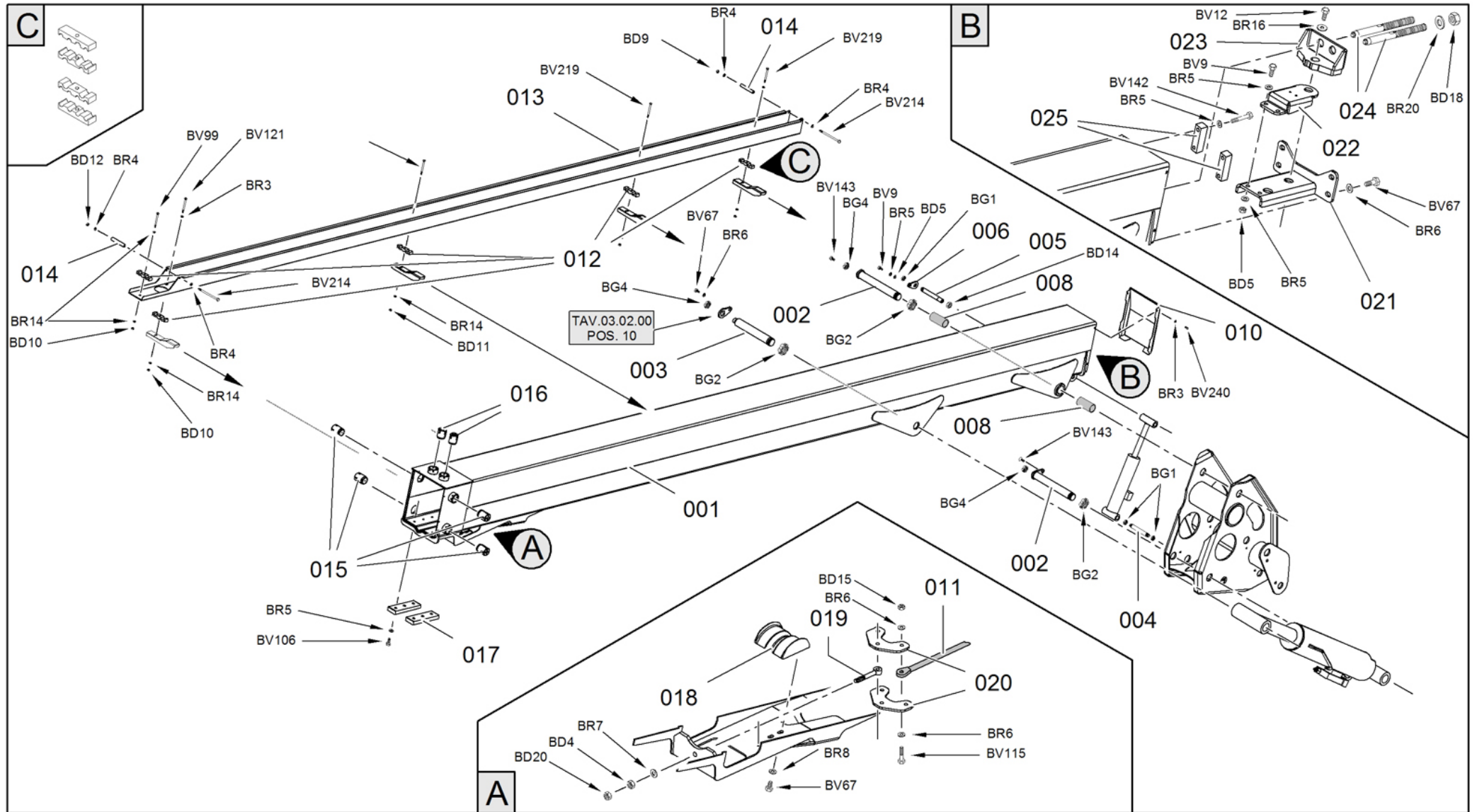
DRITTER AUSLEGERARM   
 TERCER BRAZO 



Main color codes:  J1 - JLG Cream,  J2 - JLG Orange,  C4 - Green





 TERZO BRACCIO



 THIRD ARM

 TROISIÈME BRAS

 DRITTER AUSLEGERARM

 TERCER BRAZO

POS	Codice	 Descrizione	 Description	 Designation	 Benennung	 Descripción
1	174923A1	TERZO BRACCIO	THIRD ARM	TROISIÈME BRAS	DRITTER AUSLEGERARM	TERCER BRAZO
1	174923A5	TERZO BRACCIO	THIRD ARM	TROISIÈME BRAS	DRITTER AUSLEGERARM	TERCER BRAZO
1	174923A6	TERZO BRACCIO	THIRD ARM	TROISIÈME BRAS	DRITTER AUSLEGERARM	TERCER BRAZO
1	174923A7	TERZO BRACCIO	THIRD ARM	TROISIÈME BRAS	DRITTER AUSLEGERARM	TERCER BRAZO
1	174923B9	TERZO BRACCIO	THIRD ARM	TROISIÈME BRAS	DRITTER AUSLEGERARM	TERCER BRAZO
1	174923BP	TERZO BRACCIO	THIRD ARM	TROISIÈME BRAS	DRITTER AUSLEGERARM	TERCER BRAZO
1	174923C4	TERZO BRACCIO	THIRD ARM	TROISIÈME BRAS	DRITTER AUSLEGERARM	TERCER BRAZO
1	174923CO	TERZO BRACCIO	THIRD ARM	TROISIÈME BRAS	DRITTER AUSLEGERARM	TERCER BRAZO
1	174923DI	TERZO BRACCIO	THIRD ARM	TROISIÈME BRAS	DRITTER AUSLEGERARM	TERCER BRAZO
1	174923FX	TERZO BRACCIO	THIRD ARM	TROISIÈME BRAS	DRITTER AUSLEGERARM	TERCER BRAZO
1	174923GB	TERZO BRACCIO	THIRD ARM	TROISIÈME BRAS	DRITTER AUSLEGERARM	TERCER BRAZO
1	174923J1	TERZO BRACCIO	THIRD ARM	TROISIÈME BRAS	DRITTER AUSLEGERARM	TERCER BRAZO
2	07518400	SPINA	PIN	AXE	STIFT	CLAVIJA
3	07539800	SPINA	PIN	AXE	STIFT	CLAVIJA
4	06867600	SPINA	PIN	CHEVILLE	STIFT	CLAVIJA
5	06230600	SPINA	PIN	CHEVILLE	STIFT	CLAVIJA
8	07130500	BOCCOLA 404540	BUSH	DOUILLE	BUCHSE	CASQUILLO
10	075308H3	CARTER CHIUSURA TERZO BRACCIO	COVER THIRD ARM	COUVERTURE TROISIEME BRAS	DECKUNG 3. ARM	COBERTURA 3° BRAZO
11	07520300	FUNE RIENTRO SFILO	ROPE EXTENSION IN	CORDE	SEIL	CUERDA
12	07530500	MORSETTO FERMA TUBI	CLAMP	ÉTAU	KLEMME	ABRAZADERA

**Main color codes:**  J1 - JLG Cream,  J2 - JLG Orange,  C4 - Green







 TERZO BRACCIO

 THIRD ARM

 TROISIÈME BRAS

 DRITTER AUSLEGERARM

 TERCER BRAZO

POS	Codice	 Descrizione	 Description	 Designation	 Benennung	 Descripción
13	075304H3	SUPPORTO CATENARIA	SUPPORT	SUPPORT	HALTERUNG	SOPORTE
14	06518800	DISTANZIALE	SPACER	ENTRETOISE	DISTANZSTÜCK	DISTANCIADOR
15	06301200	PATTINO	SLIDE BLOCK	PATIN	GLEITBLOCK	PATÍN
16	07246000	PATTINO IN PLASTICA	SLIDE BLOCK	PATIN	GLEITBLOCK	PATIN
17	07246700	PATTINO IN PLASTICA	SLIDE BLOCK	PATIN	GLEITELEMENT	PATIN
18	07530600	SLITTA	SLIDE	COULISSEAU	SCHLITTEN	CORREDERA
19	06458000	TIRANTE	TIE ROD	TIRANT	ZUGSTANGE	TIRANTE
20	063063H3	PIATTO	PLATE	PLATEAU	PLATTE	PLACA
21	363078Y1	SUPPORTO	SUPPORT	SUPPORT	HALTERUNG	SOPORTE
22	063061Y1	SUPPORTO	SUPPORT	SUPPORT	HALTERUNG	SOPORTE
23	363074Y1	BILANCERE	ROCKER ARM	BALANCIER	KIPPHEBEL	BALANCÍN
24	07520400	FUNE SFILO USCITA	ROPE FOR EXTENSION EXIT	CORDE	SEIL	CUERDA
24	17890600	KIT RIPRISTINO IMPIANTO FUNI SU 26 METRI	CABLES KIT	KIT CÂBLES	KABELSATZ	KIT CABLES



















 PRIMO SFILO



 FIRST EXTENSION ARM





 PREMIER BRAS D'EXTRACTION
ERSTER TELESKOPARM PRIMO BRAZO DE EXTENSION 



POS	Codice	 Descrizione	 Description	 Designation	 Benennung	 Descripción
1	374925A1	PRIMO SFILO	FIRST BOOM EXTENSION	PREMIÈR BRAS D'EXTRACTION	1. TELESKOPAUSSCHUB	PRIMERA EXTENCIÓN
1	374925A5	PRIMO SFILO	FIRST EXTENSION BOOM	PREMIÈRE PROLONGATION	ERSTE ERWEITERUNG	PRIMERA AMPLIACIÓN
1	374925A6	PRIMO SFILO	FIRST EXTENSION BOOM	PREMIÈRE PROLONGATION	ERSTE ERWEITERUNG	PRIMERA AMPLIACIÓN
1	374925A7	PRIMO SFILO	FIRST EXTENSION BOOM	PREMIÈRE PROLONGATION	ERSTE ERWEITERUNG	PRIMERA AMPLIACIÓN
1	374925B9	PRIMO SFILO	FIRST EXTENSION BOOM	PREMIÈRE PROLONGATION	ERSTE ERWEITERUNG	PRIMERA AMPLIACIÓN
1	374925BP	PRIMO SFILO	FIRST EXTENSION BOOM	PREMIÈRE PROLONGATION	ERSTE ERWEITERUNG	PRIMERA AMPLIACIÓN
1	374925C4	PRIMO SFILO	FIRST EXTENSION BOOM	PREMIÈRE PROLONGATION	ERSTE ERWEITERUNG	PRIMERA AMPLIACIÓN
1	374925CO	PRIMO SFILO	FIRST EXTENSION BOOM	PREMIÈRE PROLONGATION	ERSTE ERWEITERUNG	PRIMERA AMPLIACIÓN
1	374925DI	PRIMO SFILO	FIRST EXTENSION BOOM	PREMIÈRE PROLONGATION	ERSTE ERWEITERUNG	PRIMERA AMPLIACIÓN
1	374925FX	PRIMO SFILO	FIRST EXTENSION BOOM	PREMIÈRE PROLONGATION	ERSTE ERWEITERUNG	PRIMERA AMPLIACIÓN
1	374925GB	PRIMO SFILO	FIRST EXTENSION BOOM	PREMIÈRE PROLONGATION	ERSTE ERWEITERUNG	PRIMERA AMPLIACIÓN
1	374925J2	PRIMO SFILO	FIRST BOOM EXTENSION	PREMIÈR BRAS D'EXTRACTION	1. TELESKOPAUSSCHUB	PRIMERA EXTENCIÓN
2	06308800	PATTINO	SLIDE BLOCK	PATIN	GLEITBLOCK	PATÍN
3	16510800	PULEGGIA	PULLEY	POULIE	SCHEIBE	POLEA
4	06321100	BOCCOLA	BUSH	DOUILLE	BUCHSE	CASQUILLO
5	06422400	BOCCOLA	BUSH	DOUILLE	BUCHSE	CASQUILLO
6	06309900	SPINA	PIN	CHEVILLE	STIFT	CLAVIJA
7	072787Y1	PIATTO	PLATE	PLATEAU	PLATTE	PLACA
8	17552300	KIT SPAZZOLE	BRUSHES KIT	KIT BROSSES	BÜRSTENSATZ	KIT CEPILLOS
9	17552800	KIT SPAZZOLE	BRUSHES KIT	KIT BROSSES	BÜRSTENSATZ	KIT CEPILLOS
10	07552900	PATTINO CILINDRO SFILO	SLIDE BLOCK	PATIN	GLEITBLOCK	PATIN

Main color codes:  J1 - JLG Cream,  J2 - JLG Orange,  C4 - Green



 PRIMO SFILO  
 FIRST EXTENSION ARM  
 PREMIER BRAS D'EXTRACTION



ERSTER TELESKOPARM   
 PRIMO BRAZO DE EXTENSION 

POS	Codice	 Descrizione	 Description	 Designation	 Benennung	 Descripción
11	083319Y2	PIATTO	PLATE	PLATEAU	PLATTE	PLACA
12	07531900	PATTINO IN PLASTICA	SLIDE BLOCK	PATIN	GLEITBLOCK	PATIN
13	07607500	TUBO RIGIDO	RIGID PIPE	TUYAU RIGIDE	ROHR	TUBO RÍGIDO
14	07533000	PATTINO IN PLASTICA	SLIDE BLOCK	PATIN	GLEITELEMENT	PATIN
15	07552400	SPINA	PIN	CHEVILLE	STIFT	CLAVIJA
16	06321200	BOCCOLA	BUSH	DOUILLE	BUCHSE	CASQUILLO
17	06422300	BOCCOLA	BUSH	DOUILLE	BUCHSE	CASQUILLO
18	16710000	PULEGGIA	PULLEY	POULIE	SCHEIBE	POLEA
19	06623000	PATTINO	SLIDE BLOCK	PATIN	GLEITBLOCK	PATÍN
19	08398700	PATTINO CONTENIMENTO FUNI RIENTRO SFILO SCARICATO	BLOCK	PATIN	GLEITBLOCK	PATIN
20	06586300	PATTINO	SLIDE BLOCK	PATIN	GLEITBLOCK	PATÍN
21	06539700	RULLO	ROLLER	ROULEAU	ROLLE	RODILLO
22	06624100	GUIDA	GUIDE	GLISSIÈRE	FÜHRUNG	GUÍA
23	375332H3	SUPPORTO CATENARIA SU PRIMO SFILO	SUPPORT CABLE HOLDER CHAIN ON FIRST EXTENSION BOOM	SUPPORT	HALTERUNG	SOPORTE
24	07246800	PATTINO IN PLASTICA	SLIDE BLOCK	PATIN	GLEITELEMENT	PATIN



Main color codes:  J1 - JLG Cream,  J2 - JLG Orange,  C4 - Green





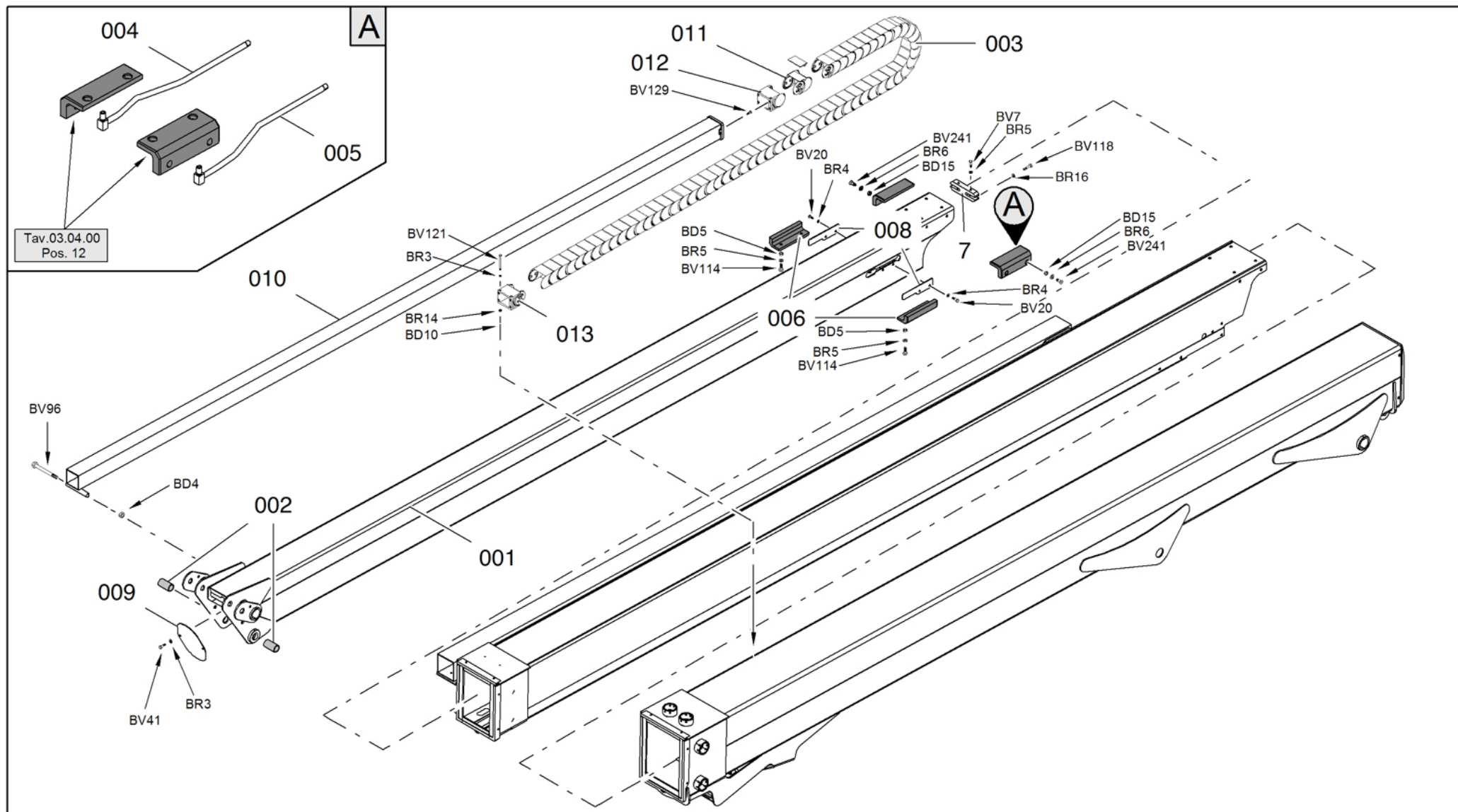

-  SECONDO SFILÒ
-  SECONDO EXTENSION ARM
-  DEUXIÈME BRAS D'EXTRACTION



ZWEITER TELESKOPARM   
 SEGUNDO BRAZO TELESCÓPICO 





Main color codes:  J1 - JLG Cream,  J2 - JLG Orange,  C4 - Green



 SECONDO SFILO  
 SECONDO EXTENSION ARM  
 DEUXIÈME BRAS D'EXTRACTION



ZWEITER TELESKOPARM   
 SEGUNDO BRAZO TELESCÓPICO 





POS	Codice	 Descrizione	 Description	 Designation	 Benennung	 Descripción
1	174926A1	SECONDO SFILO	SECOND BOOM EXTENSION	2ME BRAS D'EXTRACTION	2. TELESKOPARM	SEGUNDA EXTENSIÓN
1	174926A5	SECONDO SFILO	SECOND EXTENSION ARM	SECOND BRAS D'EXTRACTION	ZWEITER TELESKOPARM	SEGUNDO BRAZO DE EXTENSIÓN
1	174926A6	SECONDO SFILO	SECOND EXTENSION ARM	SECOND BRAS D'EXTRACTION	ZWEITER TELESKOPARM	SEGUNDO BRAZO DE EXTENSIÓN
1	174926A7	SECONDO SFILO	SECOND EXTENSION ARM	SECOND BRAS D'EXTRACTION	ZWEITER TELESKOPARM	SEGUNDO BRAZO DE EXTENSIÓN
1	174926B9	SECONDO SFILO	SECOND EXTENSION ARM	SECOND BRAS D'EXTRACTION	ZWEITER TELESKOPARM	SEGUNDO BRAZO DE EXTENSIÓN
1	174926BP	SECONDO SFILO	SECOND EXTENSION ARM	SECOND BRAS D'EXTRACTION	ZWEITER TELESKOPARM	SEGUNDO BRAZO DE EXTENSIÓN
1	174926C4	SECONDO SFILO	SECOND EXTENSION ARM	SECOND BRAS D'EXTRACTION	ZWEITER TELESKOPARM	SEGUNDO BRAZO DE EXTENSIÓN
1	174926CO	SECONDO SFILO	SECOND EXTENSION ARM	SECOND BRAS D'EXTRACTION	ZWEITER TELESKOPARM	SEGUNDO BRAZO DE EXTENSIÓN
1	174926DI	SECONDO SFILO	SECOND EXTENSION ARM	SECOND BRAS D'EXTRACTION	ZWEITER TELESKOPARM	SEGUNDO BRAZO DE EXTENSIÓN
1	174926FX	SECONDO SFILO	SECOND EXTENSION ARM	SECOND BRAS D'EXTRACTION	ZWEITER TELESKOPARM	SEGUNDO BRAZO DE EXTENSIÓN
1	174926GB	SECONDO SFILO	SECOND EXTENSION ARM	SECOND BRAS D'EXTRACTION	ZWEITER TELESKOPARM	SEGUNDO BRAZO DE EXTENSIÓN
1	174926J2	SECONDO SFILO	SECOND BOOM EXTENSION	2ME BRAS D'EXTRACTION	2. TELESKOPARM	SEGUNDA EXTENSIÓN
2	06900700	BOCCOLA	BUSH	DOUILLE	BUCHSE	CASQUILLO
3	27553000	CATENA PORTACAVI	CABLE-HOLDER CHAIN	CHAÎNE PORTE-CÂBLES	KABELHALTERKETTE	CADENA PORTACABLES
4	07607600	TUBO RIGIDO	RIGID PIPE	TUYAU RIGIDE	ROHR	TUBO RÍGIDO
4	08441500	TUBO RIGIDO INGRASSAGGIO PATTINO DX 20 SFILO LL2614 MK2	RIGID PIPE	TUYAU RIGIDE	STARRES ROHR	TUBO RIGIDO
5	07610200	TUBO RIGIDO	RIGID PIPE	TUYAU RIGIDE	ROHR	TUBO RÍGIDO



Main color codes:  J1 - JLG Cream,  J2 - JLG Orange,  C4 - Green



 SECONDO SFILO  
 SECONDO EXTENSION ARM  
 DEUXIÈME BRAS D'EXTRACTION

ZWEITER TELESKOPARM   
 SEGUNDO BRAZO TELESCÓPICO 

POS	Codice	 Descrizione	 Description	 Designation	 Benennung	 Descripción
5	08441600	TUBO RIGIDO INGRASSAGGIO PATTINO SX 2° SFILO LL2614 MK2	RIGID PIPE	TUYAU RIGIDE	STARRES ROHR	TUBO RIGIDO
6	07532000	PATTINO IN PLASTICA	SLIDE BLOCK	PATIN	GLEITELEMENT	PATIN
7	062962Y2	PIASTRA	PLATE	PLATINE	PLATTE	PLACA
8	062967Y1	COPERCHIO	COVER	COUVERCLE	DECKEL	TAPA
9	072842H3	COPERCHIO	COVER	COUVERTURE	DECKUNG	COBERTURA
10	375318H3	SUPPORTO CATENARIA SU SECONDO SFILO	SUPPORT CABLE HOLDER CHAIN ON SECOND EXTENSION BOOM	SUPPORT	HALTERUNG	SOPORTE
11	2755300001	MAGLIA COMPLETA PER CATENA PORTACAVI LL2614	CHAIN LINK	MAILLOT	KETTENGLIED	ESLABON
12	2755300002	RACCORDO PUNTO FISSO COMPLETA PER CATENA PORTACAVI LL2614	CONNECTION	RACCORD	ANSCHLUSSSTÜCK	CONEXIÓN
13	2755300003	RACCORDO PUNTO MOBILE COMPLETO PER CATENA PORTACAVI LL2614	CONNECTION	RACCORD	ANSCHLUSSSTÜCK	CONEXIÓN

Main color codes:  J1 - JLG Cream,  J2 - JLG Orange,  C4 - Green













 SUPPORTO CESTO

 ARMS SUPPORT

 SUPPORT BRAS
ARMEHALTERUNG SUPORTE BRAZOS 





POS	Codice	 Descrizione	 Description	 Designation	 Benennung	 Descripción
1	170948A1	BRACCIO JIB COMPLETO	COMPLETE JIB ARM	FLÉCHETTE BRAS COMPLÈTE	ARM - SCHWENKARM	BRAZO JIB COMPLETO
1	170948A5	BRACCIO JIB COMPLETO	COMPLETE JIB ARM	FLÉCHETTE BRAS COMPLÈTE	ARM - SCHWENKARM	BRAZO JIB COMPLETO
1	170948A6	BRACCIO JIB COMPLETO	COMPLETE JIB ARM	FLÉCHETTE BRAS COMPLÈTE	ARM - SCHWENKARM	BRAZO JIB COMPLETO
1	170948A7	BRACCIO JIB COMPLETO	COMPLETE JIB ARM	FLÉCHETTE BRAS COMPLÈTE	ARM - SCHWENKARM	BRAZO JIB COMPLETO
1	170948B9	BRACCIO JIB COMPLETO	COMPLETE JIB ARM	FLÉCHETTE BRAS COMPLÈTE	ARM - SCHWENKARM	BRAZO JIB COMPLETO
1	170948BP	BRACCIO JIB COMPLETO	COMPLETE JIB ARM	FLÉCHETTE BRAS COMPLÈTE	ARM - SCHWENKARM	BRAZO JIB COMPLETO
1	170948C4	BRACCIO JIB COMPLETO	COMPLETE JIB ARM	FLÉCHETTE BRAS COMPLÈTE	ARM - SCHWENKARM	BRAZO JIB COMPLETO
1	170948CO	BRACCIO JIB COMPLETO	COMPLETE JIB ARM	FLÉCHETTE BRAS COMPLÈTE	ARM - SCHWENKARM	BRAZO JIB COMPLETO
1	170948DI	BRACCIO JIB COMPLETO	COMPLETE JIB ARM	FLÉCHETTE BRAS COMPLÈTE	ARM - SCHWENKARM	BRAZO JIB COMPLETO
1	170948FX	BRACCIO JIB COMPLETO	COMPLETE JIB ARM	FLÉCHETTE BRAS COMPLÈTE	ARM - SCHWENKARM	BRAZO JIB COMPLETO
1	170948GB	BRACCIO JIB COMPLETO	COMPLETE JIB ARM	FLÉCHETTE BRAS COMPLÈTE	ARM - SCHWENKARM	BRAZO JIB COMPLETO
1	170948J2	BRACCIO JIB COMPLETO DX	COMPLETE JIB ARM RIGHT	BRAS JIB DROITE COMPLÈTE	KORBARM RECHTS	BRAZO JIB DERECHA COMPLETO
2	06272600	BOCCOLA	BUSH	DOUILLE	BUCHSE	CASQUILLO
3	07093500	SPINA	PIN	CHEVILLE	STIFT	CLAVIJA
4	07093800	SPINA	PIN	CHEVILLE	STIFT	CLAVIJA
5	359447A1	TIRANTE	TIE ROD	TIRANT	TURMGESTÄNGE	TIRANTE
5	359447A5	TIRANTE	TIE ROD	TIRANT	TURMGESTÄNGE	TIRANTE
5	359447A6	TIRANTE	TIE ROD	TIRANT	TURMGESTÄNGE	TIRANTE
5	359447A7	TIRANTE	TIE ROD	TIRANT	TURMGESTÄNGE	TIRANTE
5	359447B9	TIRANTE	TIE ROD	TIRANT	TURMGESTÄNGE	TIRANTE
5	359447BP	TIRANTE	TIE ROD	TIRANT	TURMGESTÄNGE	TIRANTE
5	359447C4	TIRANTE	TIE ROD	TIRANT	TURMGESTÄNGE	TIRANTE



Main color codes:  J1 - JLG Cream,  J2 - JLG Orange,  C4 - Green

 SUPPORTO CESTO

 ARMS SUPPORT

 SUPPORT BRAS
ARMEHALTERUNG SUPORTE BRAZOS 

POS	Codice	 Descrizione	 Description	 Designation	 Benennung	 Descripción
5	359447CO	TIRANTE	TIE ROD	TIRANT	TURMGESTÄNGE	TIRANTE
5	359447DI	TIRANTE	TIE ROD	TIRANT	TURMGESTÄNGE	TIRANTE
5	359447FX	TIRANTE	TIE ROD	TIRANT	TURMGESTÄNGE	TIRANTE
5	359447GB	TIRANTE	TIE ROD	TIRANT	TURMGESTÄNGE	TIRANTE
5	359447J2	TIRANTE JIB	TIE ROD JIB	TIRANT	ZUGSTANGE	TIRANTE
6	07093600	SPINA	PIN	CHEVILLE	STIFT	CLAVIJA
7	170947A1	BRACCIO JIB COMPLETO	COMPLETE JIB ARM	FLÉCHETTE BRAS COMPLÈTE	ARM - SCHWENKARM	BRAZO JIB COMPLETO
7	170947A5	BRACCIO JIB COMPLETO	COMPLETE JIB ARM	FLÉCHETTE BRAS COMPLÈTE	ARM - SCHWENKARM	BRAZO JIB COMPLETO
7	170947A6	BRACCIO JIB COMPLETO	COMPLETE JIB ARM	FLÉCHETTE BRAS COMPLÈTE	ARM - SCHWENKARM	BRAZO JIB COMPLETO
7	170947A7	BRACCIO JIB COMPLETO	COMPLETE JIB ARM	FLÉCHETTE BRAS COMPLÈTE	ARM - SCHWENKARM	BRAZO JIB COMPLETO
7	170947B9	BRACCIO JIB COMPLETO	COMPLETE JIB ARM	FLÉCHETTE BRAS COMPLÈTE	ARM - SCHWENKARM	BRAZO JIB COMPLETO
7	170947BP	BRACCIO JIB COMPLETO	COMPLETE JIB ARM	FLÉCHETTE BRAS COMPLÈTE	ARM - SCHWENKARM	BRAZO JIB COMPLETO
7	170947C4	BRACCIO JIB COMPLETO	COMPLETE JIB ARM	FLÉCHETTE BRAS COMPLÈTE	ARM - SCHWENKARM	BRAZO JIB COMPLETO
7	170947CO	BRACCIO JIB COMPLETO	COMPLETE JIB ARM	FLÉCHETTE BRAS COMPLÈTE	ARM - SCHWENKARM	BRAZO JIB COMPLETO
7	170947DI	BRACCIO JIB COMPLETO	COMPLETE JIB ARM	FLÉCHETTE BRAS COMPLÈTE	ARM - SCHWENKARM	BRAZO JIB COMPLETO
7	170947FX	BRACCIO JIB COMPLETO	COMPLETE JIB ARM	FLÉCHETTE BRAS COMPLÈTE	ARM - SCHWENKARM	BRAZO JIB COMPLETO
7	170947GB	BRACCIO JIB COMPLETO	COMPLETE JIB ARM	FLÉCHETTE BRAS COMPLÈTE	ARM - SCHWENKARM	BRAZO JIB COMPLETO
7	170947J2	BRACCIO JIB COMPLETO SX	COMPLETE JIB ARM LEFT	BRAS JIB GAUCHE	KORBARM LINKS	BRAZO JIB IZQUIERDA
8	372264H3	CAMMA MICRO JIB	MICROSWITCH CAM JIB	CAME	NOCKEN	LEVA
9	07093700	SPINA	PIN	CHEVILLE	STIFT	CLAVIJA
10	06235600	SPINA	PIN	CHEVILLE	STIFT	CLAVIJA





Main color codes:  J1 - JLG Cream,  J2 - JLG Orange,  C4 - Green





 SUPPORTO CESTO

 ARMS SUPPORT

 SUPPORT BRAS
ARMEHALTERUNG SUPORTE BRAZOS 





POS	Codice	 Descrizione	 Description	 Designation	 Benennung	 Descripción
11	175401A1	RINVIO JIB	JIB CONNECTION ROD	RENGOI	VORGELEGE	REENVIO
11	175401A5	RINVIO JIB	UPRIGHT JIB	RENGOI	VORGELEGE	REENVIO
11	175401A6	RINVIO JIB	UPRIGHT JIB	RENGOI	VORGELEGE	REENVIO
11	175401A7	RINVIO JIB	UPRIGHT JIB	RENGOI	VORGELEGE	REENVIO
11	175401B9	RINVIO JIB	UPRIGHT JIB	RENGOI	VORGELEGE	REENVIO
11	175401BP	RINVIO JIB	UPRIGHT JIB	RENGOI	VORGELEGE	REENVIO
11	175401C4	RINVIO JIB	UPRIGHT JIB	RENGOI	VORGELEGE	REENVIO
11	175401CO	RINVIO JIB	UPRIGHT JIB	RENGOI	VORGELEGE	REENVIO
11	175401DI	RINVIO JIB	UPRIGHT JIB	RENGOI	VORGELEGE	REENVIO
11	175401FX	RINVIO JIB	JIB CONNECTION ROD	RENGOI	VORGELEGE	REENVIO
11	175401GB	RINVIO JIB	UPRIGHT JIB	RENGOI	VORGELEGE	REENVIO
11	175401J2	RINVIO JIB	JIB CONNECTION ROD	RENGOI	VORGELEGE	REENVIO
12	06235700	SPINA	PIN	CHEVILLE	STIFT	CLAVIJA
13	2648910002	KIT GUARNIZIONI	SEAL KIT	KIT DE JOINTS	DICHTUNGSSATZ	KIT DE JUNTAS
13	271778A6	ATTUATORE ROTANTE	ROTARY MOTOR	ROTARY ACTUATOR	SCHWENKEINHEIT	ACTUADOR ROTATIVO
13	271778H2	MOTORE DI ROTAZIONE	ROTARY MOTOR	MOTEUR DE ROTATION	DREHANTRIEB	MOTOR ROTACIÓN
14	377660A6	SUPPORTO CESTO	BASKET SUPPORT	SUPPORT PANIER	KORBHALTERUNG	SOPORTE CESTA
14	377660H2	SUPPORTO CESTO	BASKET SUPPORT	SUPPORT PANIER	KORBHALTERUNG	SOPORTE CESTA
15	056187H3	COPERCHIO	BOX	COUVERCLE	DECKEL	TAPA
16	07190900	VITE TE DIN960 CI 8.8 M16X1.5X115 FORATA GEOMET321 PLUS XL	TE SCREW DIN960 CI 8.8 M16X1.5X115 GEOMET321 PERFORATED PLUS XL	VIS TE DIN960 CI 8,8 M16X1.5X115 FORE PLUS GEOMET321 XL	TE SCHRAUBE DIN960 CI 8,8 M16X1.5X115 GEOMET321 PERFORATED PLUS XL	TE TORNILLO DIN960 CI 8,8 M16X1.5X115 GEOMET321 PERFORADA XL
17	07146500	PERNO SUPPORTO CESTO DIAM.50	PIN SUPPORT BASKET Ø50	AXE DIAM.50 PANIER DE SOUTIEN	BOLZEN KORBHALTERUNG	CLAVIJA CESTA
18	27146200	CUSCINETTO LINEARE A SFERE 50-100	LINEAR BALL BEARING 50-100	ROULEMENT Á BILLES	LINEAR-KUGELLAGER 50-100	COJINETE DE BOLAS 50-100



Main color codes:  J1 - JLG Cream,  J2 - JLG Orange,  C4 - Green

 SUPPORTO CESTO

 ARMS SUPPORT

 SUPPORT BRAS
ARMEHALTERUNG SUPORTE BRAZOS 

POS	Codice	 Descrizione	 Description	 Designation	 Benennung	 Descripción
19	07146400	TAPPO CHIUSURA PERNI SUPPORTO CESTO DIAM.50	CAP PINS BASKET SUPPORT Ø50	BOUCHON	VERSCHLUSS	TAPÓN
20	371459A6	SLITTA FISSAGGIO CESTO PERNI DIAM.50	SLIDE BASKET MOUNTING BOLTS Ø50	GRILLE COULISSANTE MONTAGE	SLIDE RACKMONTAGE	PARRILLA CORREDIZA MONTAJE
20	371459H2	SLITTA FISSAGGIO CESTO PERNI DIAM.50	SLIDE BASKET MOUNTING BOLTS Ø50	COULISSEAU	SCHLITTEN	CORREDERA
21	06665000	FUNE	CABLE	CÂBLE	SEIL	CABLE
22	07052900	STAFFA	BRACKET	ÉTRIER	HALTEBÜGEL	ESTRIBO
23	05643600	CASSETTA PORTAMANUALE	MANUAL BOX	BOÎTE PORTE- MANUEL	BEDIENUNGSANLEIT UNGSFACH	CAJA PORTAMANUAL
25	072398H3	PIASTRA FISSAGGIO CESTO (SOLO MACCHINE MODELLO JP E JA E X17J)	FIXING PLATE BASKET (ONLY MACHINES MODEL JP AND JA AND X17J)	PLATE FIXATION DRUM	PLATE BEFESTIGUNG DRUM	PLACA FIJACIÓN TAMBOR
27	27589300	CESTO BIPOSTO 230KG PER MK2 (DA C170000893)	BASKET 2 PERSON 230KG FOR MK2 (FROM C170000893)	PANIER 2 PERSONNES POUR MK2 (FROM C170000893)	2 MANN- ARBEITSKORB FÜR MK2 (FROM C170000893)	CESTA 2 PERSONAS PARA MK2 (FROM C170000893)
27	28250000	CESTO	BASKET	PANIER POUR 2 PERSONNES	2-MANN- ARBEITSKORB	CESTA PARA DOS PERSONAS
28	06598500	FUNE	CABLE	CÂBLE	SEIL	CABLE
29	05475900	ANTIVIBRANTE	DAMPING	ANTI - VIBRANT	VIBRATIONSDÄMPFE R	ANTIVIBRANTE
30	36585800	SCALETTA	LADDER	ÉCHELLE	LEITER	ESCALERA
31	06585900	ROTELLINA	SMALL ROLLER	ROULETTE	RÄDCHEN	RUEDECILLA
32	058600H3	PIASTRA	PLATE	PLAQUE	PLATTE	PLACA
33	17569900	PROTEZIONE TELECOMANDO	PROTECTION REMOTE CONTROL	PROTECTION	SCHUTZ	PROTECCIÓN





Main color codes:  J1 - JLG Cream,  J2 - JLG Orange,  C4 - Green





 SUPPORTO CESTO

 ARMS SUPPORT

 SUPPORT BRAS
ARMEHALTERUNG SUPORTE BRAZOS 





POS	Codice	 Descrizione	 Description	 Designation	 Benennung	 Descripción
34	07766500	PERNO INCERNIERAMENTO MENSOLA SUPPORTO CESTO	PIN HINGE BRACKET SUPPORT BASKET	AXE	STIFT	PERNIO
35	377661A6	MENSOLA SUPPORTO CELLA DI CARICO	BRACKET SUPPORT LOAD CELL	BRIDE SUPPORT CELLULE DE CHARGE	STEIGBÜGELHALTER UNG FÜRLASTÜBERWACH UNGSZELLE	BRIDA SOPORTE CELULA DE CARGA
35	377661H2	MENSOLA SUPPORTO CELLA DI CARICO	BRACKET SUPPORT LOAD CELL	BRIDE SUPPORT CELLULE DE CHARGE	STEIGBÜGELHALTER UNG FÜRLASTÜBERWACH UNGSZELLE	BRIDA SOPORTE CELULA DE CARGA
37	06418600	PROTEZIONE	PROTECTION	PROTECTION	SCHUTZ	PROTECCIÓN
38	06272700	BOCCOLA	BUSH	DOUILLE	BUCHSE	CASQUILLO
40	07771500	MANIGLIA	HANDLE	POIGNÉE	GRIFF	MANIJA
41	28372000	CESTO MONOPOSTO LL2614 SKYLINE - NON PREDISPOSTO SKY GUARD	BASKET SINGLE SEAT LL2614 SKYLINE	PANIER MONOPLACE LL2614 SKYLINE	KORB EINZELSITZ LL2614 SKYLINE	CESTO MONOPLAZA LL2614 SKYLINE
43	072404H3	SUPPORTO PEDALE	PEDAL SUPPORT PLATE	TÔLE PLIÉE	HALTERUNG	SOPORTE
45	07239700	DISTANZIALE PER VITI M8 SUPPORTO CESTO (SOLO MACCHINE MODELLO JP E JA E X17J)	SPACER SCREW M8 SUPPORT BASKET (ONLY MACHINES MODEL JP AND JA AND X17J)	ENTRETOISE	DISTANZSTÜCK	DISTANCIADOR
46	07031800	TUBO	PIPE	TUYAU	ROHR	TUBO
47	07193000	DADO AD INTAGLI UNI5593 CI 8 M16X1.5 GEOMET321 PLUS XL	NUT M16X1.5 NOTCHES UNI5593 CI 8 GEOMET321 PLUS XL	ÉCROU UNI5593 CI 8 M16X1.5 GEOMET321 PLUS XL	MUTTER UNI5593 CI 8 M16X1.5 GEOMET321 PLUS XL	TUERCA UNI5593 CI 8 M16X1.5 GEOMET321 PLUS XL



Main color codes:  J1 - JLG Cream,  J2 - JLG Orange,  C4 - Green

 SUPPORTO CESTO





 ARMS SUPPORT



 SUPPORT BRAS
ARMEHALTERUNG SUPORTE BRAZOS 



POS	Codice	 Descrizione	 Description	 Designation	 Benennung	 Descripción
48	07192600	RONDELLA SPECIALE HV 300 - D 17X48X6 GEOMET321/A+PLUS XL	SPECIAL WASHER HV 300 - 17X48X6 GEOMET321 D / A + PLUS XL	RONDELLE SPECIALE HV 300 - 17X48X6 GEOMET321 D / A + PLUS XL	SCHEIBE HV 300 - 17X48X6 GEOMET321 D / A + PLUS XL	ARANDELA ESPECIAL HV 300 - 17X48X6 GEOMET321 D / A + PLUS XL
49	07690700	PROTEZIONE TRASPARENTE	PROTECTION	PROTECTION	SCHUTZ	PROTECCIÓN
50	07192700	CHIUSURA A VOLANTINO CON LEVA PIEGATA (SOLO MACCHINE MODELLO JP E JA E X17J)	LOCKING WHEEL WITH BENT LEVER (ONLY MACHINES MODEL JP AND JA AND X17J)	POIGNEE DE BLOCAGE	KUGELVERSCHLUSS	POMO DE BLOQUEO
51	07687300	RUOTE INFERIORI PER CESTO	LOWER WHEEL	ROULEAU INFERIEUR	UNTERES RAD	RUEDA INFERIOR
52	07751100	RUOTE INFERIORI PER CESTO CON FRENO	LOWER WHEELS FOR BASKET WITH BRAKE	ROUES POUR PANIER	KORBRÄDER	RUEDAS
53	37609800	TELAIO SUPPORTO SKY-GUARD CESTO BIPOSTO	SKY-FRAME SUPPORT GUARD BASKET 2PERSON	CHÂSSIS	RAHMEN	CHASIS
53	37675400	TELAIO SUPPORTO SKY-GUARD CESTO MONOPOSTO	SKY-FRAME SUPPORT GUARD BASKET 1PERSON	CHÂSSIS SUPPORT	RAHMEN HALTERUNG	BASTIDOR SOPORTE
54	07796900	BLOCCHETTO PLASTICA PER FISSAGGIO SKYGUARD (1001188889)	BLOCK PLASTIC FOR SECURING SKYGUARD (1001188889)	BLOC	BLOCK	BLOQUE
55	07797000	COVER IN GOMMA PER PROTEZIONE FISSAGGIO SKY GUARD (1001186517)	COVER RUBBER PROTECTION FOR FIXING SKY GUARD (1001186517)	PROTECTION	SCHUTZ	PROTECCIÓN
56	27796800	SENSORE SKYGUARD	SENSOR SKYGUARD	CAPTEUR	SENSOR	SENSOR



Main color codes:  J1 - JLG Cream,  J2 - JLG Orange,  C4 - Green

 SUPPORTO CESTO ARMS SUPPORT SUPPORT BRASARMEHALTERUNG SUPORTE BRAZOS 



POS	Codice	 Descrizione	 Description	 Designation	 Benennung	 Descripción
57	17768100	KIT SKY GUARD COMPLETO BIPOSTO PER CCBS	SKYGUARD COMPLETE KIT FOR 2 PERSON CCBS	KIT SKY GUARD	SKY GUARD SATZ	KIT SKY GUARD
57	17768300	KIT SKY GUARD COMPLETO MONOPOSTO PER CCBS	SKYGUARD COMPLETE KIT FOR SINGLE PERSON CCBS	KIT SKY GUARD	SATZ SKY GUARD	KIT SKY GUARD
57	18357300	KIT SKY LINE COMPLETO BIPOSTO HINOWA	SKYLINE COMPLETE KIT FOR 2 PERSON HINOWA	KIT SKY LINE	SKY LINE SATZ	KIT SKY LINE

Main color codes:  J1 - JLG Cream,  J2 - JLG Orange,  C4 - Green

 ACCOPPIAMENTO MOTORE - POMPA  
 ENGINE COUPLING - PUMP  
 ACCOUPLEMENT MOTEUR - POMPE

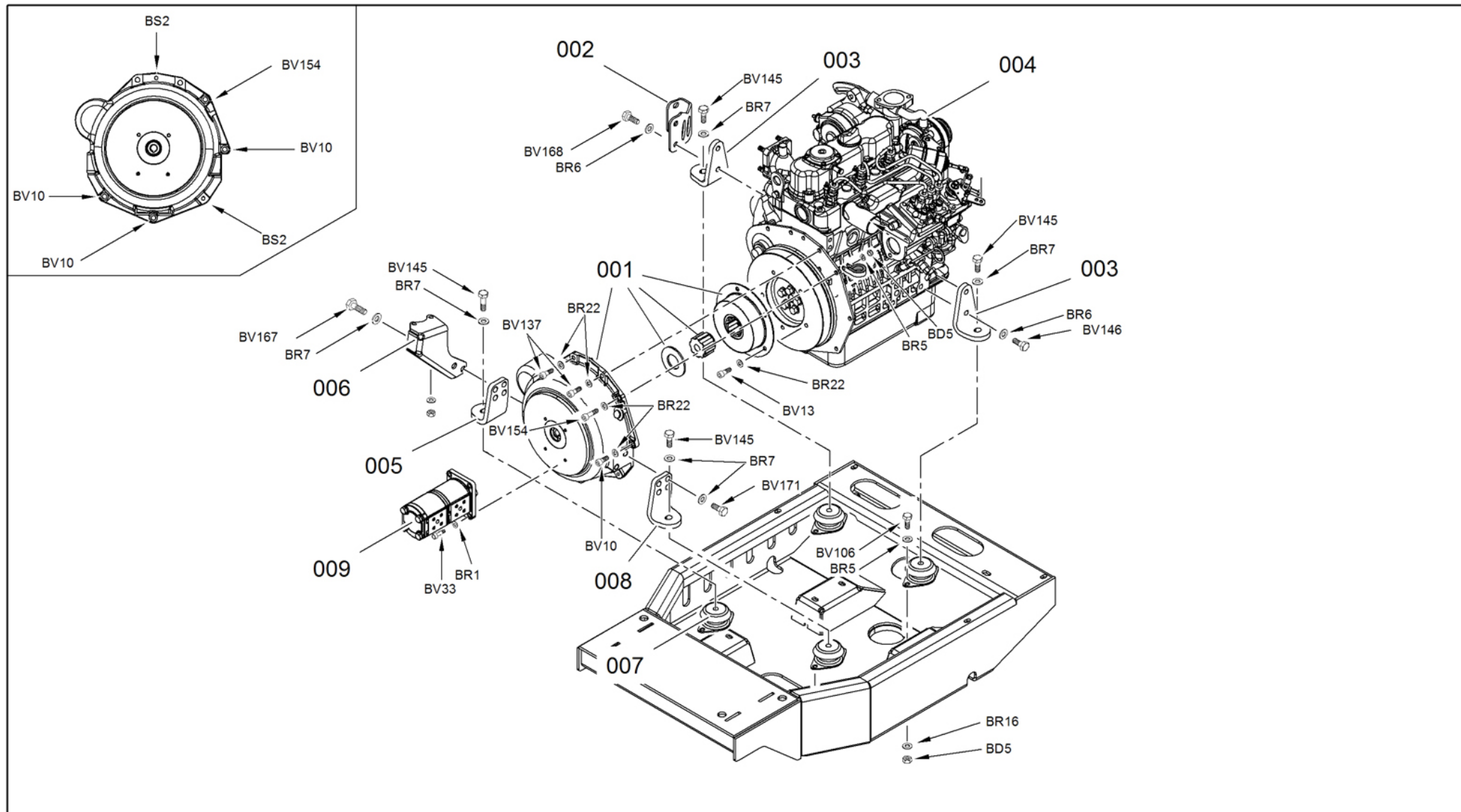
PUMPEN / MOTOR KUPPLUNG   
 ACOPLAMIENTO MOTOR - BOMBA 



Main color codes:  J1 - JLG Cream,  J2 - JLG Orange,  C4 - Green



 ACCOPPIAMENTO MOTORE - POMPA

 ENGINE COUPLING - PUMP

 ACCOUPLEMENT MOTEUR - POMPE

 PUMPEN / MOTOR KUPPLUNG

 ACOPLAMIENTO MOTOR - BOMBA

POS	Codice	 Descrizione	 Description	 Designation	 Benennung	 Descripción
1	27560400	ACCOPPIAMENTO MOTORE-POMPA	HYDRAULIC PUMP-MOTOR COUPLING	ACCOUPLEMENT MOTEUR-POMPE	MOTOR-PUMPE KUPPLUNG	ACOPLAMIENTO MOTOR-BOMBA
2	075720Y1	STAFFA	BRACKET	ÉTRIER	HALTEBÜGEL	ESTRIBO
3	075718Y1	SUPPORTO MOTORE KUBOTA POSTERIORE	SUPPORT	SUPPORT	HALTERUNG	SOPORTE
4	27494100	KIT MOTORE KUBOTA CON ACCESSORI	KIT KUBOTA ENGINE WITH ATTACHMENTS	KIT MOTEUR KUBOTA AVEC ACCESSOIRES	KUBOTA MOTOR MIT ZUBEHÖREN	KIT MOTOR KUBOTA CON ACCESORIOS
4	28055100	KIT MOTORE KUBOTA CON ACCESSORI	KIT KUBOTA ENGINE WITH ATTACHMENTS	KIT MOTEUR KUBOTA AVEC ACCESSOIRES	KUBOTA MOTOR MIT ZUBEHÖREN	KIT MOTOR KUBOTA CON ACCESORIOS
5	075716Y1	SUPPORTO MOTORE KUBOTA SINISTRO	LEFT KUBOTA ENGINE SUPPORT	SUPPORT MOTEUR KUBOTA GAUCHE	HALTERUNG KUBOTA MOTOR	SOPORTE MOTOR KUBOTA IZQUIERDO
6	075719Y1	STAFFA FISSAGGIO ANTERIORE MARMITTA	BRACKET	BRIDE	BÜGEL	BRIDA
7	27018000	ANTIVIBRANTE	ANTI-VIBRATING	ANTI - VIBRANT	VIBRATIONSDÄMPFER	ANTIVIBRANTE
8	075717Y1	SUPPORTO MOTORE KUBOTA DESTRO	RIGHT KUBOTA ENGINE SUPPORT	SUPPORT MOTEUR KUBOTA DROITE	KUBOTA MOTOR HALTERUNG	SOPORTE MOTOR KUBOTA DERECHO
9	146152H3	POMPA IDRAULICA	HYDRAULIC PUMP	POMPE HYDRAULIQUE	HYDRAULIKPUMPE	BOMBA HYDRÁULICA
9	275205H3	POMPA IDRAULICA	HYDRAULIC PUMP	POMPE HYDRAULIQUE	HYDRAULIKPUMPE	BOMBA HYDRÁULICA



 RICAMBI MOTORE DIESEL



 ENGINE SPARE PARTS DIESEL

 PIÈCES DÉTACHÉES DU MOTEUR DIESEL

MOTORSATZTEILE DIESEL 

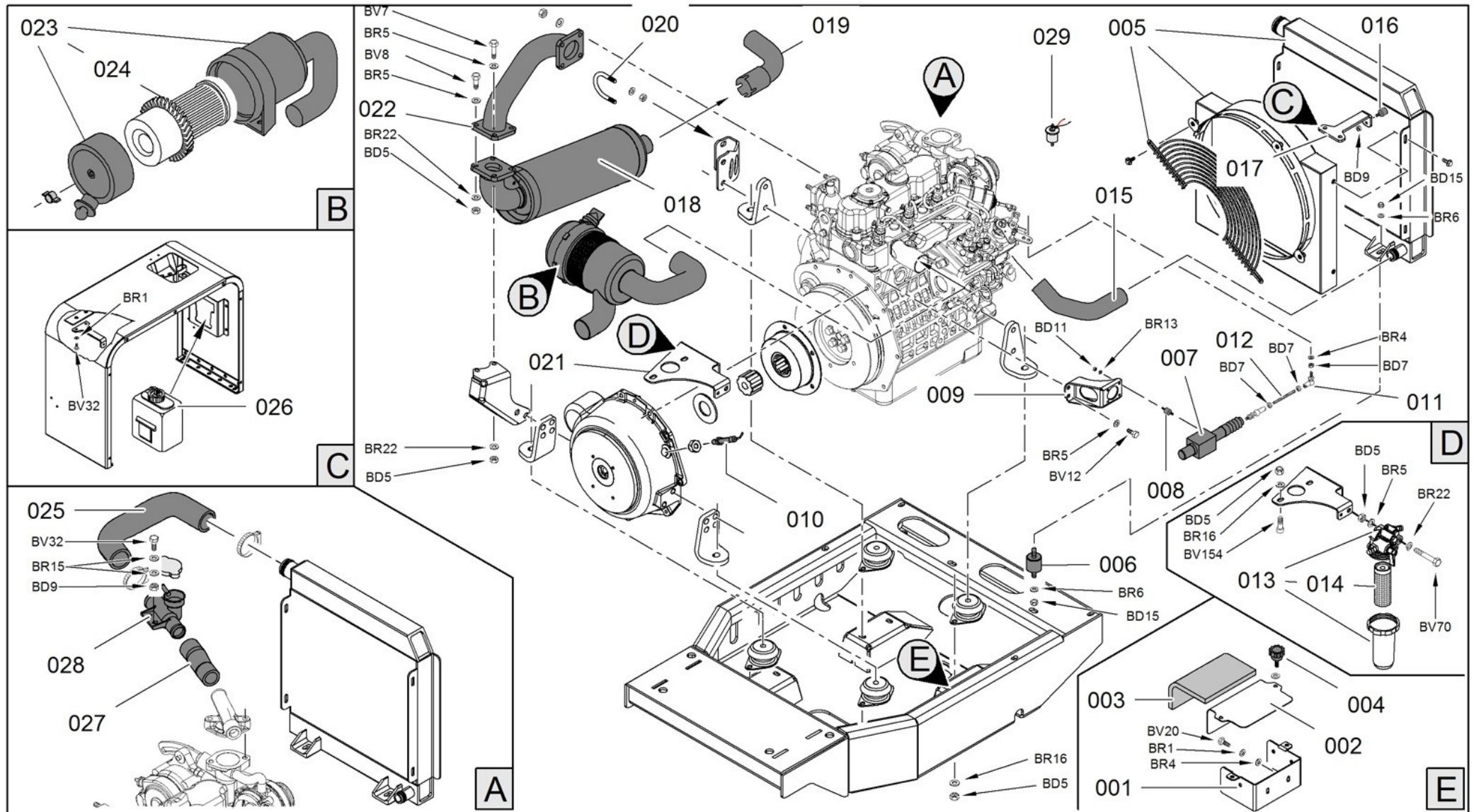
REPUESTOS MOTOR DIESEL 



Main color codes:  J1 - JLG Cream,  J2 - JLG Orange,  C4 - Green





 RICAMBI MOTORE DIESEL

 ENGINE SPARE PARTS DIESEL

 PIÈCES DÉTACHÉES DU MOTEUR DIESEL
MOTORERSATZTEILE DIESEL REPUESTOS MOTOR DIESEL 

POS	Codice	 Descrizione	 Description	 Designation	 Benennung	 Descripción
1	075991Y1	PIEGATO FISSAGGIO COMPONENTI ELETTRICI	SUPPORT	SUPPORT	HALTERUNG	SOPORTE
2	075992Y1	COPERCHIO	COVER	COUVERCLE	DECKEL	TAPA
3	07647100	RIVESTIMENTO	PROTECTION	PROTECTION	SCHUTZ	PROTECCION
5	27554600	RADIATORE	RADIATOR	RADIATEUR	KÜHLER	RADIATOR
6	06145700	ANTIVIBRANTE	ANTI-VIBRATING	ANTI - VIBRANT	VIBRATIONS DÄMPFER	ANTIVIBRANTE
7	26551500	PISTONE	PISTON	PISTON	KOLBEN	PISTÓN
8	06551400	ANTIVIBRANTE	ANTI-VIBRATING	ANTI - VIBRANT	VIBRATIONS DÄMPFER	ANTIVIBRANTE
9	075985Y1	STAFFA	BRACKET	BRIDE	BÜGEL	BRIDA
10	27602400	SENSORE DI GIRI PICK UP L=20,62MM	RPM SENSOR	CAPTEUR	DREHZAHLSENSOR	SENSOR
11	07598700	SNODO	ANGLE JOINTS	ARTICULATION	GELENK	ARTICULACIÓN
12	07598600	TIRANTE FILETTATO M6	TIE ROD	TIRANT	ZUGSTANGE	TIRANTE
13	17404200	FILTRO GASOLIO PER MOTORE KUBOTA Z602 D902	DIESEL FILTER FOR KUBOTA ENGINE Z602 D902	FILTRE À GASOIL POUR MOTEUR KUBOTA Z602 D902	DIESELFILTER FÜR KUBOTA MOTOR Z602 D902	FILTRO GASOIL PARA MOTOR KUBOTA Z602 D902
14	1740420001	CARTUCCIA FILTRO GASOLIO PER MOTORE Z602 D902	DIESEL FILTER CARTRIDGE FOR Z602 ENGINE D902	CARTOUCHE FILTRE À GASOIL POUR MOTEUR Z602 D902	DIESELFILTERELEMENT FÜR Z602 MOTOR D902	CARTUCHO FILTRO GASOIL PARA MOTOR Z602 D902
15	07598900	MANICOTTO	MUFF	MANCHON	MUFFE	MANGUITO
16	05689400	ANTIVIBRANTE Ø25 H=15 FILETTO M6X18	ANTIVIBRATION Ø25 H = 15 M6X18	ANTI - VIBRANT	VIBRATIONS DÄMPFER	ANTIVIBRANTE
17	064699Y1	STAFFA	BRACKET	ÉTRIER	HALTEBÜGEL	ESTRIBO
18	27598400	KIT SILENZIATORE PER MOTORE KUBOTA D902	SILENCER	SILENCIEUX	SCHALLDÄMPFER	SILENCIADOR
19	07589400	TERMINALE MARMITTA	EXHAUST	PARTIE FINALE POT D'ÉCHAPPEMENT	AUSPUFFENDE	TERMINAL DE ESCAPE
20	07635600	FASCETTA	CLAMP	COLLIER	KLEMMSCHRAUBE	ABRAZADERA

Main color codes:  J1 - JLG Cream,  J2 - JLG Orange,  C4 - Green





 RICAMBI MOTORE DIESEL

 ENGINE SPARE PARTS DIESEL



 PIÈCES DÉTACHÉES DU MOTEUR DIESEL



 MOTORERSATZTEILE DIESEL

 REPUESTOS MOTOR DIESEL



POS	Codice	 Descrizione	 Description	 Designation	 Benennung	 Descripción
21	375778Y1	STAFFA FILTRO ARIA	AIR FILTER BRACKET	SUPPORT DE FILTRE A AIR	LUFTFILTERHALTER	SOPORTE DE FILTRO DE AIRE
21	381099Y1	STAFFA FILTRO GASOLIO	FUEL FILTER BRACKET	ÉTRIER FILTRE DIESEL	BÜGEL DIESELFILTER	ESTRIBO FILTRO DIESEL
22	07577900	COLLETTORE	MANIFOLD	COLLECTEUR	AUSPUFFSAMMLER	COLECTOR
23	08110100	MANICOTTO ASPIRAZIONE ARIA	AIR INTAKE SLEEVE	TUYAU D'ASPIRATION D'AIR	LUFTSAUGSCHLAUCH	MANGUERA ASPIRACION AIRE
23	2749410002	FILTRO ARIA COMPLETO SINGOLA CARTUCCIA PER KUBOTA D902	AIR FILTER	FILTRE A AIR	LUFTFILTER	FILTRO DE AIRE
24	274941000201	CARTUCCIA FILTRO ARIA PER KUBOTA D902	AIR FILTER	FILTRE A AIR	LUFTFILTER	FILTRO DE AIRE
25	07541500	MANICOTTO DI COLLEGAMENTO	HOSE CONNECTION	MANCHON	MUFFE	MANGUITO
26	25779900	VASCHETTA ACQUA	WATER RESERVOIR	BASSINET EAU	WASSERBECKEN	PILA AQUA
27	07541400	MANICOTTO COLLEGAMENTO MOTORE-TAPPO	HOSE CONNECTING MOTOR-CAP	MANCHON	MUFFE	MANGUITO
28	27598800	RIEMPIMENTO ACQUA RADIATORE COMPLETO DI TAPPO	RADIATOR WATER FILLING COMPLETE WITH CAP	COUVERCLE	DECKEL	TAPA
29	2749410001	POMPA GASOLIO AGGIUNTIVA PER MOTORE KUBOTA	PUMP	POMPE	PUMPE	BOMBA

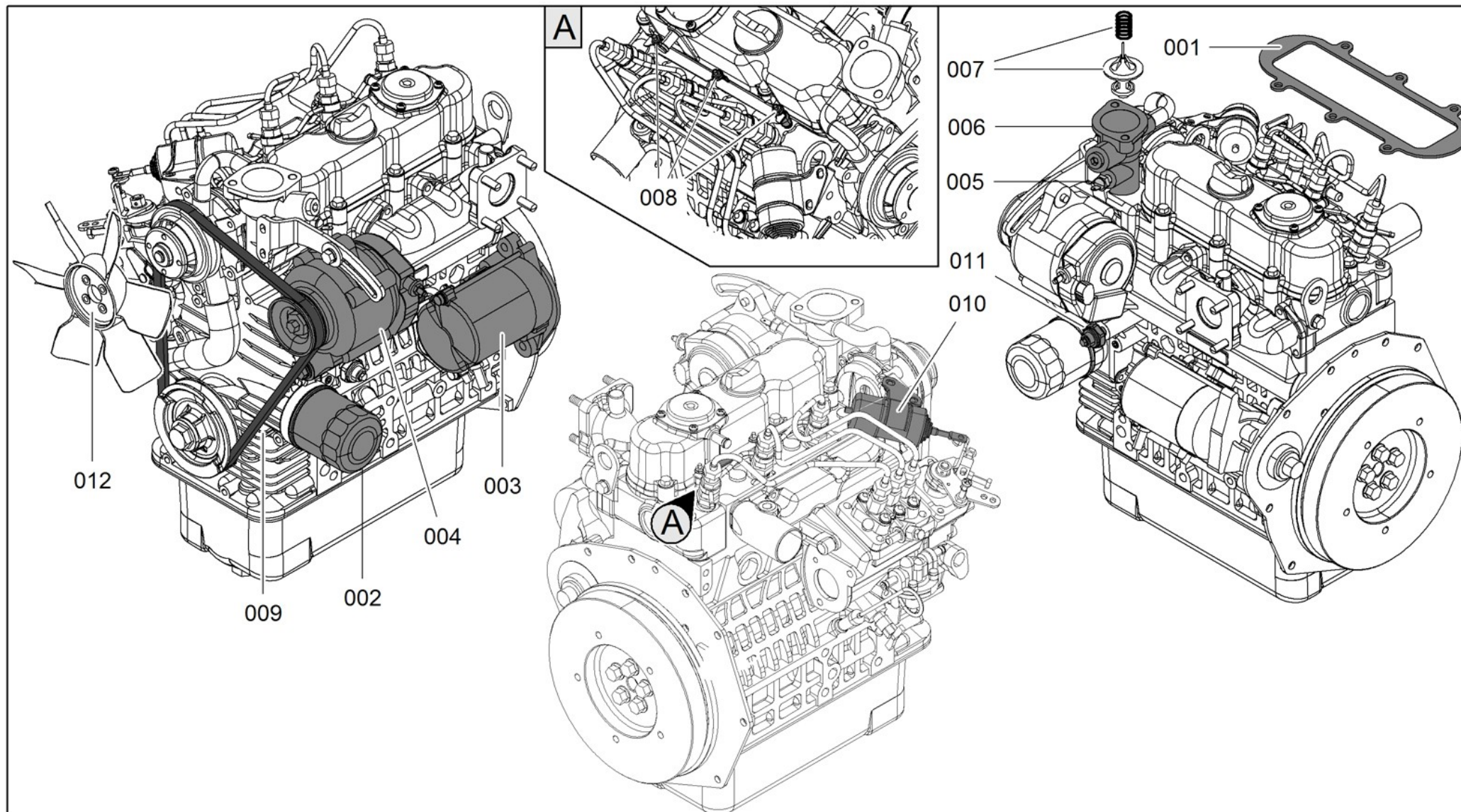

-  RICAMBI MOTORE DIESEL
-  ENGINE SPARE PARTS DIESEL
-  PIÈCES DÉTACHÉES DU MOTEUR DIESEL

- MOTORERSATZTEILE DIESEL 
- REPUESTOS MOTOR DIESEL 











Main color codes:  J1 - JLG Cream,  J2 - JLG Orange,  C4 - Green

 RICAMBI MOTORE DIESEL

 ENGINE SPARE PARTS DIESEL

 PIÈCES DÉTACHÉES DU MOTEUR DIESEL
MOTORERSATZTEILE DIESEL REPUESTOS MOTOR DIESEL 

POS	Codice	 Descrizione	 Description	 Designation	 Benennung	 Descripción
1	2749410003	GUARNIZIONE COPERCHIO PUNTERIE PER MOTORE KUBOTA D902	GASKET	JOINT	DICHTUNG	JUNTA
2	2734250002	CARTUCCIA FILTRO OLIO PER MOTORE Z602 D902	CARTRIDGE OLI FILTER FOR DIESEL Z602 D902	CARTOUCHE FILTRE À HUILE POUR MOTEUR Z602 D902	ÖLFILTERPATRONE FÜR MOTOR Z602 D902	CARTUCHO FILTRO ACEITE PARA MOTOR Z602 D902
3	2749410005	MOTORINO AVVIAMENTO	STARTER	DEMARREUR	ANLASSER	MOTOR DE ARRANQUE
4	2734250013	ALTERNATORE PER MOTORE Z602 D902	ALTERNATOR FOR MOTOR Z602 D902	ALTERNATEUR POUR MOTEUR Z602 D902	ALTERNATOR FÜR MOTOR Z602 D902	ALTERNADOR PARA MOTOR Z602 D902
5	2734250009	BULBO ACQUA PER MOTORE Z602 D902	WATER SENSOR FOR MOTOR Z602 D902	BOULE EAU POUR MOTEUR Z602 D902	WASSER-SENSOR FÜR MOTOR Z602 D902	BOLA AGUA PARA MOTOR Z602 D902
6	2734250010	POMPA ACQUA PER MOTORE Z602 D902	WATER PUMP FOR MOTOR Z602 D902	POMPE À EAU POUR MOTEUR Z602 D902	WASSERPUMPE FÜR MOTOR Z602 D902	BOMBA DE AGUA PARA MOTOR Z602 D902
7	2734250008	TERMOSTATO PER MOTORE Z602 D902	TEMPERATURE SENSOR FOR MOTOR Z602 D902	THERMOSTAT POUR MOTEUR Z602 D902	THERMOSTAT FÜR MOTOR Z602 D902	TERMÓSTATO PARA MOTOR Z602 D902
8	2749410004	CANDELETTA KUBOTA PER MOTORE D902	GLOW FOR KUBOTA ENGINE D902	PETITE BOUGIE KUBOTA POUR MOTEUR D902	ZÜNDKERZEN KUBOTA FÜR MOTOR D902	BUJÍA KUBOTA PARA MOTOR D902
9	2734250011	CINGHIA PER MOTORE Z602 D722 D902	BELT FOR MOTOR Z602 D722 D902	COURROIE POUR MOTEUR Z602 D722 D902	MOTORRIEMEN Z602 D722 D902	CORREA PARA MOTOR Z602 D722 D902
10	2734250004	SOLENOIDE STOP PER MOTORE Z602 D902	STOP SOLENOID FOR MOTOR Z602 D902	ARRÊT SOLENOÏDE POUR MOTEUR Z602 D902	MAGNETSCHALTER FÜR MOTOR Z602 D902	SOLENOIDE STOP PARA MOTOR Z602 D902
11	2734250007	BULBO OLIO PER MOTORE Z602 D902	SENSOR ENGINE OIL Z602 D902	BOULE HUILE POUR MOTEUR Z602 D902	ÖLSENSOR FÜR MOTOR Z602 D902	BOLA ACEITE PARA MOTOR Z602 D902
12	2734250001	VENTOLA ASPIRANTE PER MOTORE Z602 D902	SUCTION FAN FOR DIESEL Z602 D902	VENTILATEUR D'ASPIRATION Z602 D902	SAUGLÜFTERRAD Z602 D902	VANTILADOR DE ASPIRACIÓN PARA MOTOR Z602 D902

Main color codes:  J1 - JLG Cream,  J2 - JLG Orange,  C4 - Green





 RICAMBI MOTORE DIESEL

 ENGINE SPARE PARTS DIESEL

 PIÈCES DÉTACHÉES DU MOTEUR DIESEL



MOTORERSATZTEILE DIESEL 



REPUESTOS MOTOR DIESEL 

<b>POS</b>	<b>Codice</b>	 <b>Descrizione</b>	 <b>Description</b>	 <b>Designation</b>	 <b>Benennung</b>	 <b>Descripció</b>
12	2805510001	VENTOLA SOFFIANTE PER MOTORE D902	FAN FOR DIESEL D902	VENTILATEUR D902	SAUGLÜFTERRAD D902	VANTILADOR PARA MOTOR D902





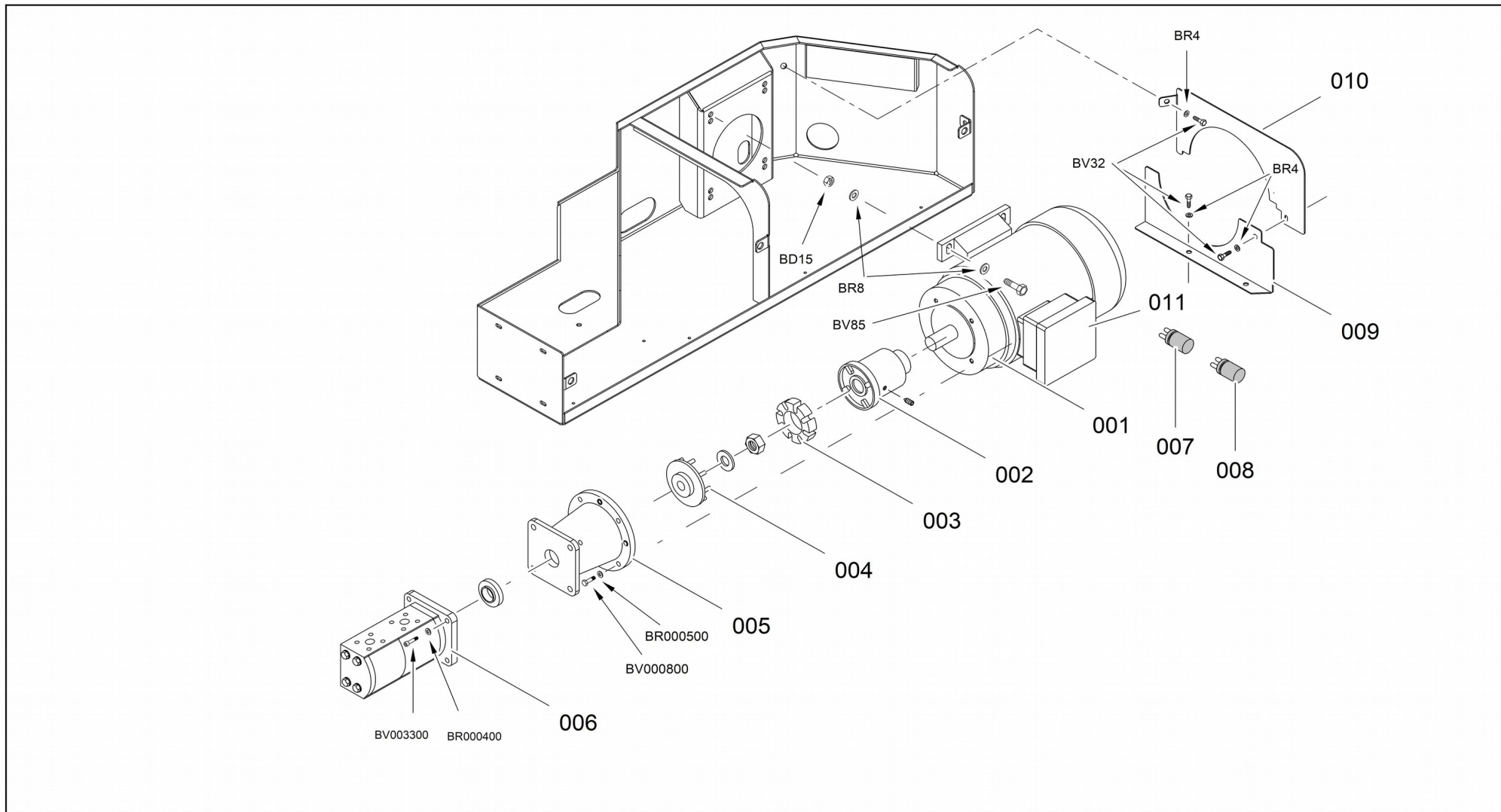

 MOTORI ELETTRICI E POMPA  
 ELECTRIC MOTOR  
 MOTEUR ÉLECTRIQUE

E-MOTOR   
MOTOR ELÉCTRICO 











Main color codes:  J1 - JLG Cream,  J2 - JLG Orange,  C4 - Green

 MOTORI ELETTRICI E POMPA

 ELECTRIC MOTOR

 MOTEUR ÉLECTRIQUE
E-MOTOR MOTOR ELÉCTRICO 





POS	Codice	 Descrizione	 Description	 Designation	 Benennung	 Descripción
1	25576400	MOTORE ELETTRICO 110V	ELECTRIC MOTOR 110V	MOTEUR ÉLECTRIQUE 110V	E-MOTOR 110V	MOTOR ELÉCTRICO 110V
1	26219000	MOTORE ELETTRICO 230V 60HZ	ELECTRIC MOTOR 230V 60HZ	MOTEUR ÉLECTRIQUE 230V 60HZ	E-MOTOR 230V 60HZ	MOTOR ELÉCTRICO 230V 60HZ
1	26948000	MOTORE ELETTRICO 3500W LITHIUM 72V	ELECTRIC MOTOR 3500W LITHIUM 72V	MOTEUR ÉLECTRIQUE 3500W LITHIUM 72V	E-MOTOR 3500W LITHIUM 72V	MOTOR ELÉCTRICO 3500W LITHIUM 72V
1	27691100	MOTORE ELETTRICO 230V 50HZ MK2 (DA C170000893)	ELECTRIC MOTOR 230V 50HZ MK2 (FROM C170000893)	MOTEUR ÉLECTRIQUE 230V 50HZ MK2 (FROM C170000893)	E-MOTOR 230V 50HZ MK2 (FROM C170000893)	MOTOR ELÉCTRICO 230V 50HZ MK2 (FROM C170000893)
1	27704300	MOTORE ELETTRICO 120V 60HZ 15.8NM MAX	ELECTRIC MOTOR 120V 60HZ 15.8NM MAX	MOTEUR ÉLECTRIQUE 120V 60HZ 15.8NM MAX	E-MOTOR 120V 60HZ 15.8NM MAX	MOTOR ELÉCTRICO 120V 60HZ 15.8NM MAX
2	05563400	SEMIGIUNTO VERSIONE MOTORE ELETTRICO STANDARD	HALF COUPLING ELECTRIC MOTOR STANDARD VERSION	DEMI-JOINT	HALBKUPPLUNG	SEMI-ACOPLAMIENTO
2	06997800	SEMIGIUNTO VERSIONE LITIO	HALF COUPLING LITHIUM VERSION	DEMI-JOINT	HALBKUPPLUNG	SEMI-ACOPLAMIENTO
3	04310100	INSERTO IN GOMMA	RUBBER INSERT	INSERT EN CAOUTCHOUC	GUMMIEINSATZ	INSERTO DE GOMA
4	04615300	GIUNTO	COUPLING	JOINT	VERBINDUNG	ACOPLAMIENTO
5	05510200	LANTERNA	LANTERN	LANTERNE	LATERNE	LINTERNA
6	263281H3	POMPA IDRAULICA	HYDRAULIC PUMP	POMPE HYDRAULIQUE	HYDRAULIKPUMPE	BOMBA HYDRÁULICA
6	27763400	POMPA IDRAULICA 1.6CC PER MOTORE 120V	HYDRAULIC PUMP 1.6CC FOR ELECTRIC MOTOR 120V	POMPE HYDRAULIQUE 1.6CC	HYDRAULIKPUMPE 1.6CC	BOMBA HYDRÁULICA 1.6CC
7	2557640001	CONDENSATORE 110V MF200 D=65	CAPACITOR 110V MF200 D=65	CONDENSATEUR	CAPACITOR	CAPACITOR
7	2769110001	CONDENSATORE 230V MF80 D=60 CL.B	CAPACITOR 230V MF80 D=60 CL.B	CONDENSATEUR D=60 CL.B	KONDENSATOR D=60 CL.B	CONDENSADOR D=60 CL.B

Main color codes:  J1 - JLG Cream,  J2 - JLG Orange,  C4 - Green

 MOTORI ELETTRICI E POMPA

 ELECTRIC MOTOR

 MOTEUR ÉLECTRIQUE
E-MOTOR MOTOR ELÉCTRICO 

POS	Codice	 Descrizione	 Description	 Designation	 Benennung	 Descripción
8	2557640002	CONDENSATORE 110V MF500	CAPACITOR 110V MF500	CONDENSATEUR	CAPACITOR	CAPACITOR
8	2632830002	CONDENSATORE PER MOTORE 120V MF160 D=60	CAPACITOR MOTOR 120V MF160 D = 60	CONDENSATEUR	KONDENSATOR	CONDENSADOR
9	076990Y1	PIEGATO INFERIORE PER ASPIRAZIONE MOTORE ELETTRICO	PROTECTION	PROTECTION	SCHUTZ	PROTECCION
9	076994Y1	PIEGATO INFERIORE PER ASPIRAZIONE MOTORE ELETTRICO VERSIONE LITIO	PROTECTION	PROTECTION	SCHUTZ	PROTECCION
10	076991Y1	PIEGATO SUPERIORE PER ASPIRAZIONE MOTORE ELETTRICO	PROTECTION	PROTECTION	SCHUTZ	PROTECCION
10	076995Y1	PIEGATO SUPERIORE PER ASPIRAZIONE ELETTRICO VERSIONE LITIO	PROTECTION	PROTECTION	SCHUTZ	PROTECCION
11	2769110002	SCATOLA CONDENSATORE CON GUARNIZIONE	CONDENSER BOX WITH GASKET	BOÎTE DE CONDENSEUR	KONDENSATORCAST EN	CAJA CONDENSADOR











 IMPIANTO IDRAULICO MANDATA E SCARICO



 SUPPLY AND DISCHARGE HYDRAULIC SYSTEM

 SYSTÈME HYDRAULIQUE REFOULEMENT ET DÉCHARGEME

 HYDRAULIKANLAGE VORLÄUFE UND RÜCKLAUF

 INSTALACIÓN HIDRÁULICA IMPULSIONES Y DESCARGA



POS	Codice	 Descrizione	 Description	 Designation	 Benennung	 Descripción
1	04845400	FLANGIA 1/2"G	FLANGE 1/2"G	BRIDE 1/2"G	FLANSCH 1/2"G	BRIDA 1/2"G
2	04048100	FLANGIA 3/8" G	FLANGE 3/8" G	BRIDE 3/8" G	FLANSCH 3/8" G	BRIDA 3/8" G
3	16517700	LEVA	LEVER	LEVIER	HEBEL	PALANCA
4	26459400	POMPA A MANO	HAND PUMP	POMPE MANUELLE	HANDPUMPE	BOMBA DE MANO
5	16478200	VALVOLA IDRAULICA	HYDRAULIC VALVE	VALVE HYDRAULIQUE	HYDRAULIKVENTIL	VÁLVULA HIDRÁULICA
6	26964400	PRESSOSTATO	PRESSURE SWITCH	PRESSOSTAT	DRUCKSCHALTER	PRESÓSTATO
7	03014400	PROVA PRESSIONE 1/4" G	PRESSURE TEST 1/4" G	PREUVE PRESSION 1/4" G	DRUCKKONTROLLE 1/4" G	PRUEBA PRESIÓN 1/4" G
8	1647820001	VALVOLA IDRAULICA	HYDRAULIC VALVE	VALVE HYDRAULIQUE	HYDRAULIKVENTIL	VÁLVULA HIDRÁULICA
9	1647820003	ELETTROVALVOLA	SOLENOID VALVE	ÉLECTROVANNE	MAGNETVENTIL	ELECTROVÁLVULA
10	07580400	TUBO RIGIDO	RIGID PIPE	TUYAU RIGIDE	ROHR	TUBO RÍGIDO
11	07580500	TUBO RIGIDO	RIGID PIPE	TUYAU RIGIDE	ROHR	TUBO RÍGIDO
12	07580600	TUBO RIGIDO	RIGID PIPE	TUYAU RIGIDE	ROHR	TUBO RÍGIDO
13	07580300	TUBO RIGIDO	RIGID PIPE	TUYAU RIGIDE	ROHR	TUBO RÍGIDO
14	07628100	TUBO FLESSIBILE	FLEXIBLE PIPE	TUYAU FLEXIBLE	SCHLAUCH	TUBO FLEXIBLE
15	07627900	TUBO FLESSIBILE	FLEXIBLE PIPE	TUYAU FLEXIBLE	SCHLAUCH	TUBO FLEXIBLE
16	07628200	TUBO FLESSIBILE	FLEXIBLE PIPE	TUYAU FLEXIBLE	SCHLAUCH	TUBO FLEXIBLE
17	07628300	TUBO FLESSIBILE	FLEXIBLE PIPE	TUYAU FLEXIBLE	SCHLAUCH	TUBO FLEXIBLE
18	07628500	TUBO FLESSIBILE	FLEXIBLE PIPE	TUYAU FLEXIBLE	SCHLAUCH	TUBO FLEXIBLE
19	07628400	TUBO FLESSIBILE	FLEXIBLE PIPE	TUYAU FLEXIBLE	SCHLAUCH	TUBO FLEXIBLE

Main color codes:  J1 - JLG Cream,  J2 - JLG Orange,  C4 - Green



 IMPIANTO IDRAULICO MANDATA E SCARICO

 SUPPLY AND DISCHARGE HYDRAULIC SYSTEM

 SYSTÈME HYDRAULIQUE REFOULEMENT ET DÉCHARGEME

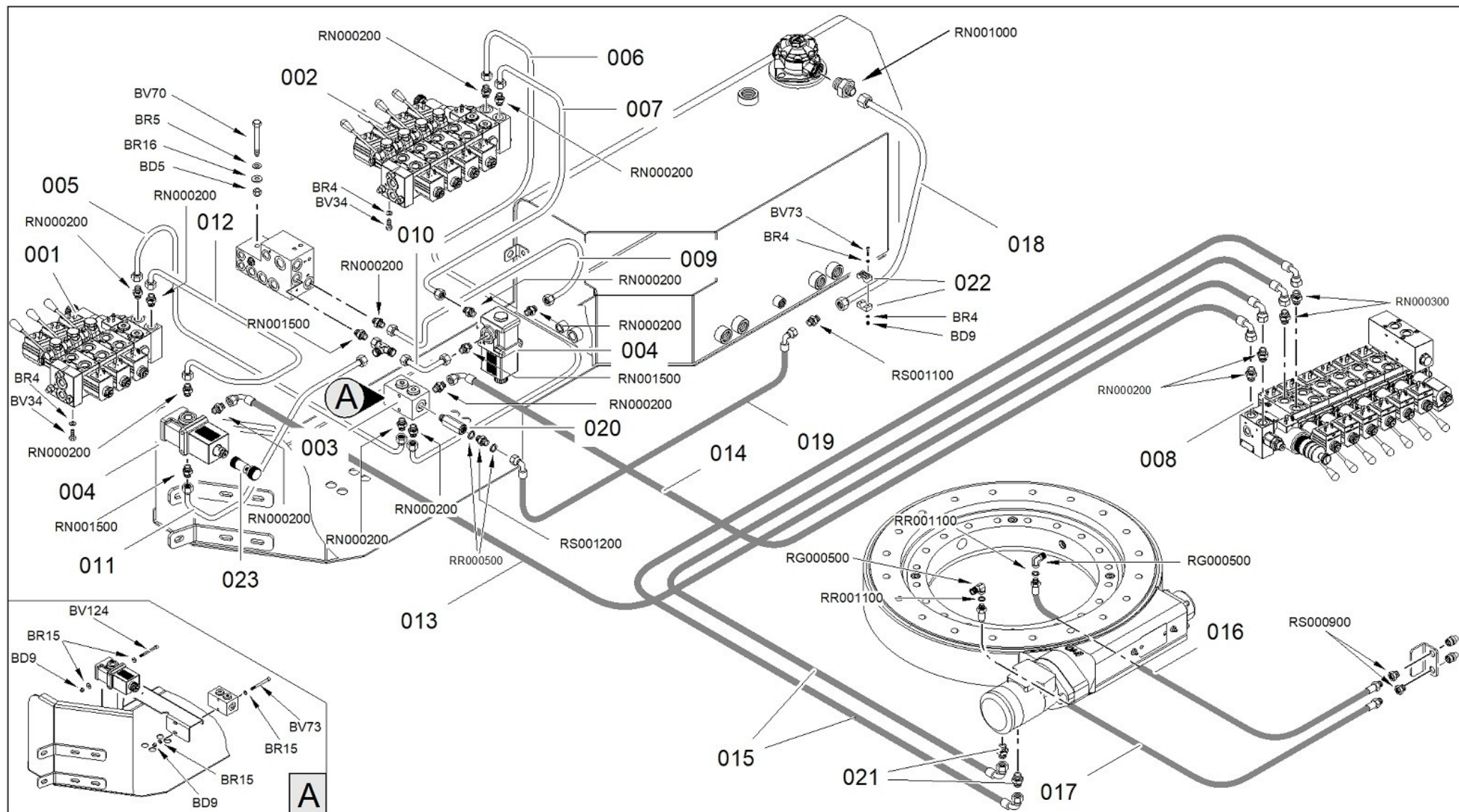
HYDRAULIKANLAGE VORLÄUFE UND RÜCKLAUF   
 INSTALACIÓN HIDRÁULICA IMPULSIONES Y DESCARGA 











Main color codes:  J1 - JLG Cream,  J2 - JLG Orange,  C4 - Green

 IMPIANTO IDRAULICO MANDATA E SCARICO

 SUPPLY AND DISCHARGE HYDRAULIC SYSTEM

 SYSTÈME HYDRAULIQUE REFOULEMENT ET DÉCHARGEME
HYDRAULIKANLAGE VORLÄUFE UND RÜCKLAUF INSTALACIÓN HIDRÁULICA IMPULSIONES Y DESCARGA 

POS	Codice	 Descrizione	 Description	 Designation	 Benennung	 Descripción
1	27299000	DISTRIBUTORE LC STABILIZZATORI-TRAIINO 3 ELEMENTI CON LEVE EMERGENZA A PULSANTE	HYDRAULIC DISTRIBUTOR STABILIZERS-TRACKS 3 PARTS WITH LEVERS EMERGENCY BUTTON	DISTRIBUTEUR HYDRAULIQUE	HYDR. REGELSTEUERGERÄT	DISTRIBUIDOR HIDRÁULICO
2	27299100	DISTRIBUTORE LC STABILIZZATORI-TRAIINO 4 ELEMENTI CON LEVE EMERGENZA A PULSANTE	HYDRAULIC DISTRIBUTOR STABILIZERS-TRACKS 4 PARTS WITH LEVERS EMERGENCY BUTTON	DISTRIBUTEUR HYDRAULIQUE	HYDRAULIKVENTILB LOCK	DISTRIBUIDOR HIDRÁULICO
3	05497500	BLOCCHETTO TUBI	HOSES BLOCK	BLOC TUYAUX	ROHRBLOCK	BLOQUE TUBOS
4	25733000	DEVIATORE 3 VIE LC VS81 AN (LC)	3-WAY VALVES	DÉVIATEUR	3-WEGEVENTIL	DESVIADOR
5	07580800	TUBO RIGIDO	RIGID PIPE	TUYAU RIGIDE	ROHR	TUBO RÍGIDO
6	07580700	TUBO RIGIDO	RIGID PIPE	TUYAU RIGIDE	ROHR	TUBO RÍGIDO
7	07580900	TUBO RIGIDO	RIGID PIPE	TUYAU RIGIDE	ROHR	TUBO RÍGIDO
8	27533400	DISTRIBUTORE IDRAULICO 7 ELEMENTI PARTE AEREA CON PULSANTE (FOR LL1775-X17JP-X500AJ-LL2010-X20JP-X600AJ MK2 FROM C170000893)	HYDRAULIC DISTRIBUTOR 7 ELEMENTS AERIAL PART WITH BUTTON (FOR LL1775-X17JP-X500AJ-LL2010-X20JP-X600AJ MK2 FROM C170000893)	DISTRIBUTEUR HYDRAULIQUE (FOR LL1775-X17JP-X500AJ-LL2010-X20JP-X600AJ MK2 FROM C170000893)	HYDRAULISCHER VERTEILER (FOR LL1775-X17JP-X500AJ-LL2010-X20JP-X600AJ MK2 FROM C170000893)	DISTRIBUIDOR HIDRÁULICO (FOR LL1775-X17JP-X500AJ-LL2010-X20JP-X600AJ MK2 FROM C170000893)
9	07581100	TUBO RIGIDO	RIGID PIPE	TUYAU RIGIDE	ROHR	TUBO RÍGIDO
10	07581300	TUBO RIGIDO	RIGID PIPE	TUYAU RIGIDE	ROHR	TUBO RÍGIDO
11	07581200	TUBO RIGIDO	RIGID PIPE	TUYAU RIGIDE	ROHR	TUBO RÍGIDO
12	07581000	TUBO RIGIDO	RIGID PIPE	TUYAU RIGIDE	ROHR	TUBO RÍGIDO
13	07629000	TUBO FLESSIBILE	FLEXIBLE PIPE	TUYAU FLEXIBLE	SCHLAUCH	TUBO FLEXIBLE
14	07629100	TUBO FLESSIBILE	FLEXIBLE PIPE	TUYAU FLEXIBLE	SCHLAUCH	TUBO FLEXIBLE
15	07628900	TUBO FLESSIBILE	FLEXIBLE PIPE	TUYAU FLEXIBLE	SCHLAUCH	TUBO FLEXIBLE

Main color codes:  J1 - JLG Cream,  J2 - JLG Orange,  C4 - Green





 IMPIANTO IDRAULICO MANDATA E SCARICO

 SUPPLY AND DISCHARGE HYDRAULIC SYSTEM

 SYSTÈME HYDRAULIQUE REFOULEMENT ET DÉCHARGEME



 HYDRAULIKANLAGE VORLÄUFE UND RÜCKLAUF



 INSTALACIÓN HIDRÁULICA IMPULSIONES Y DESCARGA

POS	Codice	 Descrizione	 Description	 Designation	 Benennung	 Descripción
16	07629600	TUBO FLESSIBILE	FLEXIBLE PIPE	TUYAU FLEXIBLE	SCHLAUCH	TUBO FLEXIBLE
17	07629700	TUBO FLESSIBILE	FLEXIBLE PIPE	TUYAU FLEXIBLE	SCHLAUCH	TUBO FLEXIBLE
18	07580200	TUBO RIGIDO	RIGID PIPE	TUYAU RIGIDE	ROHR	TUBO RÍGIDO
19	07628000	TUBO FLESSIBILE	FLEXIBLE PIPE	TUYAU FLEXIBLE	SCHLAUCH	TUBO FLEXIBLE
20	07647200	RACCORDO	PIPE FITTING	RACCORD	ANSCHLUSS	CONEXIÓN
21	06936300	RACCORDO SPECIALE 1/2" 10L Ø=1,2MM	SPECIAL FITTING 1/2" 10L Ø=1,2MM	RACCORD	ANSCHLUSS	CONEXIÓN
22	04096900	MORSETTO	CLAMP	ÉTAU	KLEMME	ABRAZADERA
23	2573300001	COMANDO MANUALE DEVIATORE 3 VIE LC VS81 AN (LC)	VALVE	SOUPAPE	VENTIL	VALVULA









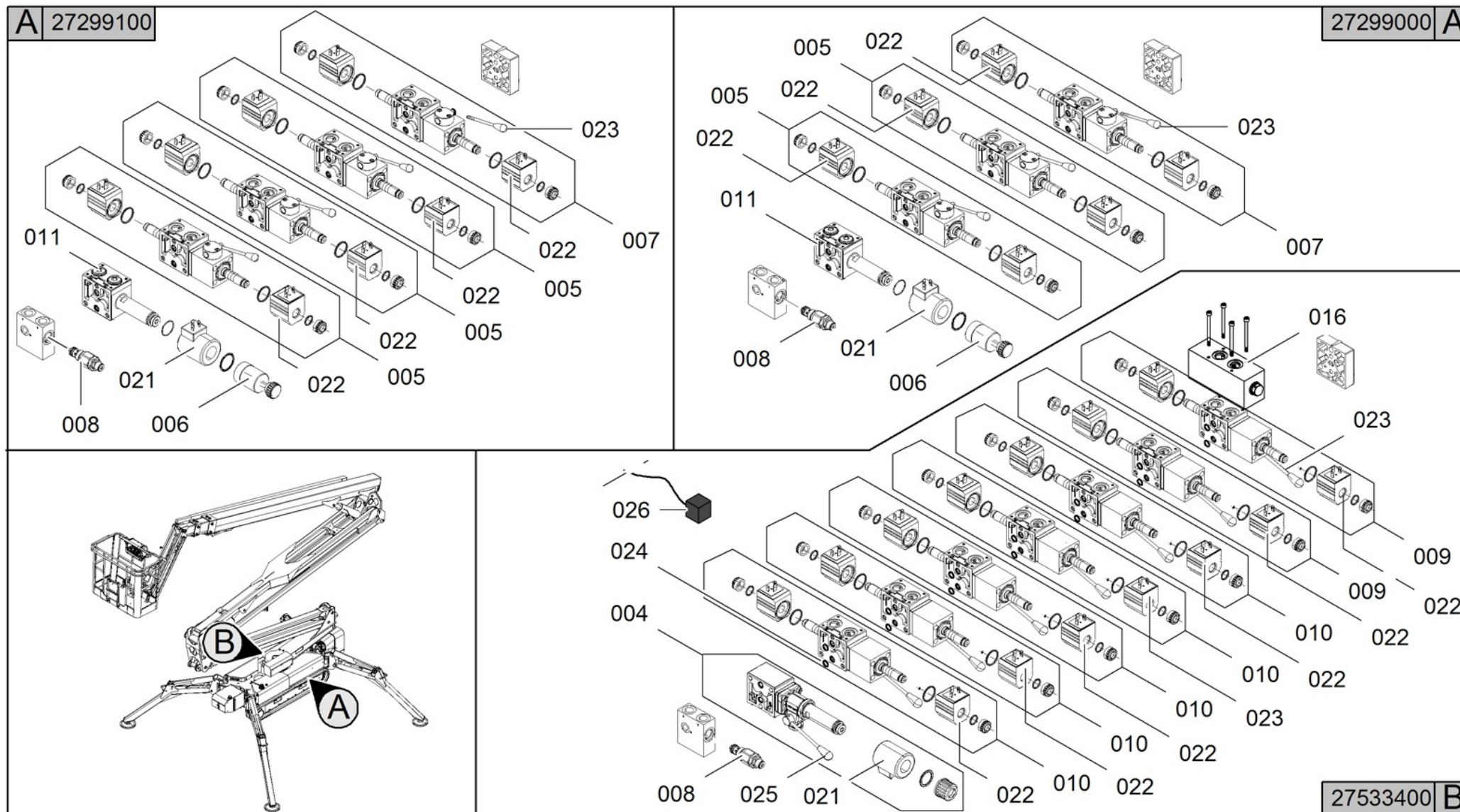

 DISTRIBITORI IDRAULICI  
 HYDRAULIC DISTRIBUTORS  
 DISTRIBUTEURS HYDRAULIQUES



HYDRAULISCHE REGELSTEUERGERÄTE   
 DISTRIBUIDORES HIDRÁULICOS 











Main color codes:  J1 - JLG Cream,  J2 - JLG Orange,  C4 - Green



 DISTRIBUTORI IDRAULICI  
 HYDRAULIC DISTRIBUTORS  
 DISTRIBUTEURS HYDRAULIQUES



HYDRAULISCHE REGELSTEUERGERÄTE   
DISTRIBUIDORES HIDRÁULICOS 

POS	Codice	 Descrizione	 Description	 Designation	 Benennung	 Descripción
2	07325200	VALVOLA PROPORZIONALE (CARTUCCIA) PARTE AEREA PIATTAFORME CON RITORNO A MOLLA COMPLETA DI PULSANTE	PROPORTIONAL VALVE AERIAL PARTS WITH SPRING RETURN COMPLETE BUTTON	SOUPAPE PROPORTIONELLE	PROPORTIONALVENTIL	VALVULA PROPORCIONAL
3	06037900	BOBINA PER VALVOLA PROPORZIONALE PARTE AEREA	COIL PROPORTIONAL VALVE FOR AERIAL PART	BOBINE	SPULE	BOBINA
4	2753340004	ELEMENTO DISTRIBUTORE COMPLETO DI PROPORZIONALE PARTE AEREA CON LEVA ROSSA (LATO 1)	VALVE BLOCK ELEMENT	ELEMENT DISTRIBUTEUR	VENTILBLOCKSATZ	ELEMENTO DISTRIBUIDOR
5	2645900005	SEZIONE DISTRIBUTORE AB CHIUSO CON LEVA (LATO A) E BOBINA	VALVE BLOCK SECTION AB CLOSED WITH LEVER (SIDE A) AND COIL	SECTION DISTRIBUTEUR	VENTILBLOCKSEKTION	SECCIÓN DISTRIBUIDOR
6	07324900	COMANDO MANUALE EMERGENZA CON RITORNO A MOLLA	EMERGENCY MAUAL CONTROL WITH SPRING RETURN	COMMANDE MANUEL D'URGENCE	MANUELLES ANTRIEB FÜR NOTSTAND	MANDO MANUAL DE EMERGENCIA
7	2645900006	SEZIONE DISTRIBUTORE ABT CON LEVA (LATO A) E BOBINA	VALVE BLOCK SECTION ABT WITH LEVER (SIDE A) AND COIL	SECTION DISTRIBUTEUR	VENTILBLOCKSEKTION	SECCIÓN DISTRIBUIDOR
8	2645900002	CARTUCCIA VALVOLA DI MASSIMA PRESSIONE	CARTRIDGE PRESSURE RELIEF VALVE	CARTOUCHE SOUPAPE DE SÉCURITÉ	PARTONE ÜBERDRUCKVENTIL	CATUCHO VÁLVULA LIMITADORA DE PRESIÓN



Main color codes:  J1 - JLG Cream,  J2 - JLG Orange,  C4 - Green



 DISTRIBUTORI IDRAULICI HYDRAULIC DISTRIBUTORS DISTRIBUTEURS HYDRAULIQUESHYDRAULISCHE REGELSTEUERGERÄTE DISTRIBUIDORES HIDRÁULICOS 

POS	Codice	 Descrizione	 Description	 Designation	 Benennung	 Descripción
9	2753340002	SEZIONE DISTRIBUTORE ABT CON LEVA (LATO 1) E BOBINA	SECTION DISTRIBUTOR ABT WITH LEVER (SIDE 1) AND COIL	SECTION DISTRIBUTEUR	VENTILBLOCKSEKTIO N	SECCIÓN DISTRIBUIDOR
10	2753340001	SEZIONE DISTRIBUTORE AB CHIUSO CON LEVA (LATO 1) E BOBINA	SECTION DISTRIBUTOR AB CLOSED WITH LEVER (SIDE 1) AND COIL	SECTION DISTRIBUTEUR	VENTILBLOCKSEKTIO N	SECCIÓN DISTRIBUIDOR
11	2729900001	VALVOLA PROPORZIONALE TRAINI CON BOBINA E SENZA COMANDO MANUALE A MOLLA	PROPORTIONAL VALVE FOR TRACK WITH COIL AND WITHOUT MANUAL SPRING	SOUPAPE PROPORTIONELLE	PROPORTIONALVENT IL	VÁLVULA PROPORCIONAL
16	2585560004	BLOCCO VALVOLA BILANCIAMENTO BRACCI SU DISTRIBUTORI PARTE AEREA	BALANCING VALVE BLOCK BOOMS OF DISTRIBUTORS AERIAL PART	BLOC SOUPAPE	VENTILSPERRE	BLOQUE VÁLVULA
21	06037100	BOBINA PER VALVOLA PROPORZIONALE PARTE CARRO	COIL PROPORTIONAL VALVE FOR UNDERCARRIAGE	BOBINE	SPULE	BOBINA
22	05913800	BOBINA PER ON-OFF	COIL FOR ON-OFF	BOBINE	SPULE	BOBINA
23	07300200	LEVA DISTRIBUTORE	LEVER HYDRAULIC DISTRIBUTOR	LEVIER	HEBEL	PALANCA
24	2585560005	O-RING	O-RING	O-RING	O-RING	O-RING
25	2753340003	LEVA ROSSA DISTRIBUTORE	RED LEVER HYDRAULIC DISTRIBUTOR	LEVIER	HEBEL	PALANCA
26	1730720001	ELETTROVALVOLA ON-OFF CON LED	SOLENOID ON-OFF WITH LED	ELECTROVANNE ON- OFF AVEC LED	SOLENOID ON-OFF WITH LED	SOLENOIDE ON-OFF CON LED



Main color codes:  J1 - JLG Cream,  J2 - JLG Orange,  C4 - Green

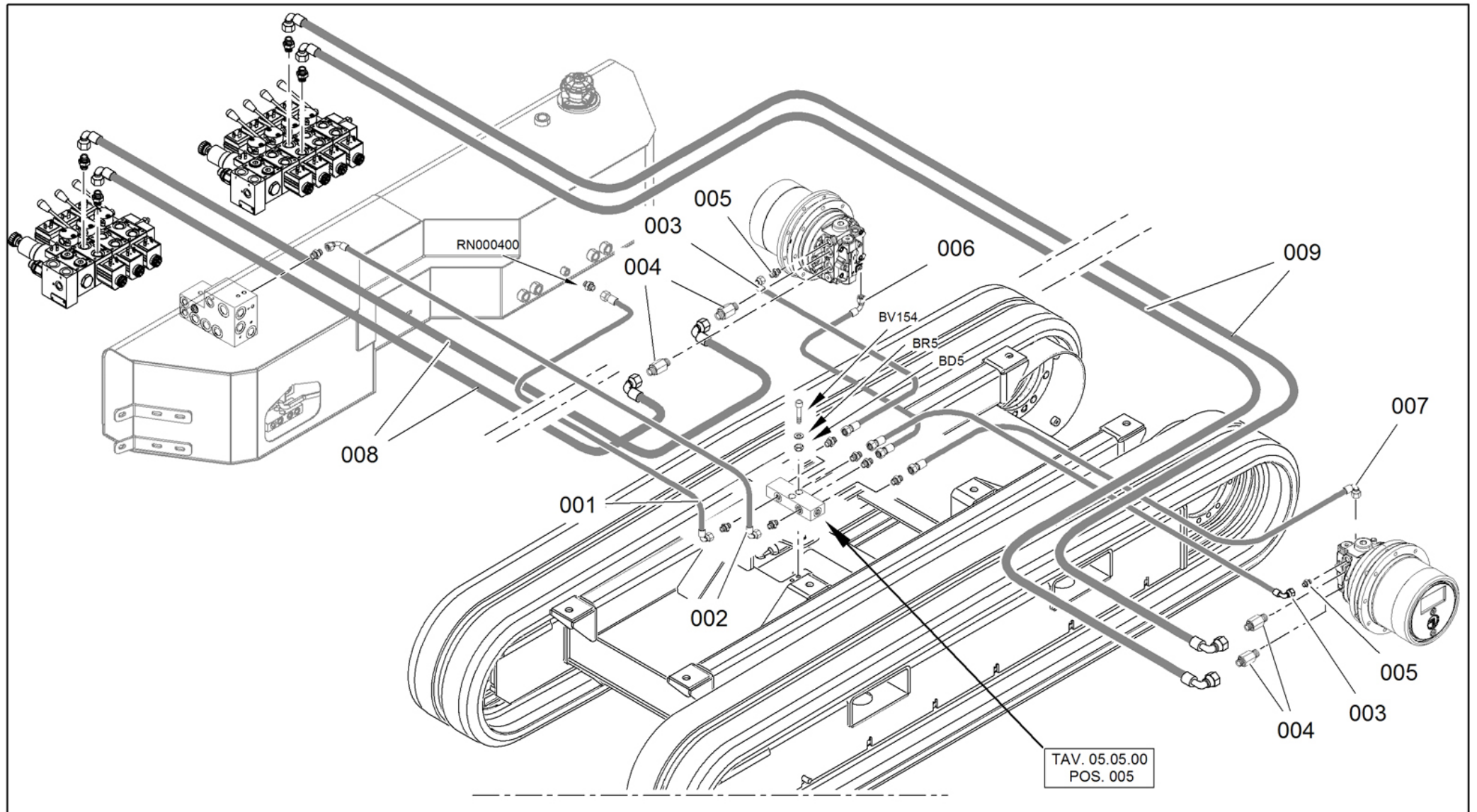

 IMPIANTO IDRAULICO TRAZIONE  
 HYDRAULIC SYSTEM FOR TRACTION  
 SYSTÈME HYDRAULIQUE DE TRACTION

HYDRAULIKANLAGE ANTRIEB   
 INSTALACIÓN HIDRÁULICA TRACCIÓN 











Main color codes:  J1 - JLG Cream,  J2 - JLG Orange,  C4 - Green



 IMPIANTO IDRAULICO TRAZIONE



 HYDRAULIC SYSTEM FOR TRACTION

 SYSTÈME HYDRAULIQUE DE TRACTION
HYDRAULIKANLAGE ANTRIEB INSTALACIÓN HIDRÁULICA TRACCIÓN 



POS	Codice	 Descrizione	 Description	 Designation	 Benennung	 Descripción
1	07629300	TUBO FLESSIBILE	FLEXIBLE PIPE	TUYAU FLEXIBLE	SCHLAUCH	TUBO FLEXIBLE
2	07629200	TUBO FLESSIBILE	FLEXIBLE PIPE	TUYAU FLEXIBLE	SCHLAUCH	TUBO FLEXIBLE
3	07630000	TUBO FLESSIBILE	FLEXIBLE PIPE	TUYAU FLEXIBLE	SCHLAUCH	TUBO FLEXIBLE
4	05094100	RACCORDO	FITTING	RACCORD	ANSCHLUSS	CONEXIÓN
5	05582000	RACCORDO	FITTING	RACCORD	ANSCHLUSS	CONEXIÓN
6	07629800	TUBO FLESSIBILE	FLEXIBLE PIPE	TUYAU FLEXIBLE	SCHLAUCH	TUBO FLEXIBLE
7	07629900	TUBO FLESSIBILE	FLEXIBLE PIPE	TUYAU FLEXIBLE	SCHLAUCH	TUBO FLEXIBLE
8	07629400	TUBO FLESSIBILE	FLEXIBLE PIPE	TUYAU FLEXIBLE	SCHLAUCH	TUBO FLEXIBLE
9	07629500	TUBO FLESSIBILE	FLEXIBLE PIPE	TUYAU FLEXIBLE	SCHLAUCH	TUBO FLEXIBLE

Main color codes:  J1 - JLG Cream,  J2 - JLG Orange,  C4 - Green

 IMPIANTO IDRAULICO ALLARGAMENTO CARRO  
 HYDRAULIC SYSTEM UNDERCARRIAGE EXPANSION  
 SYSTÈME HYDRAULIQUE EXTENSION DU CHARIOT

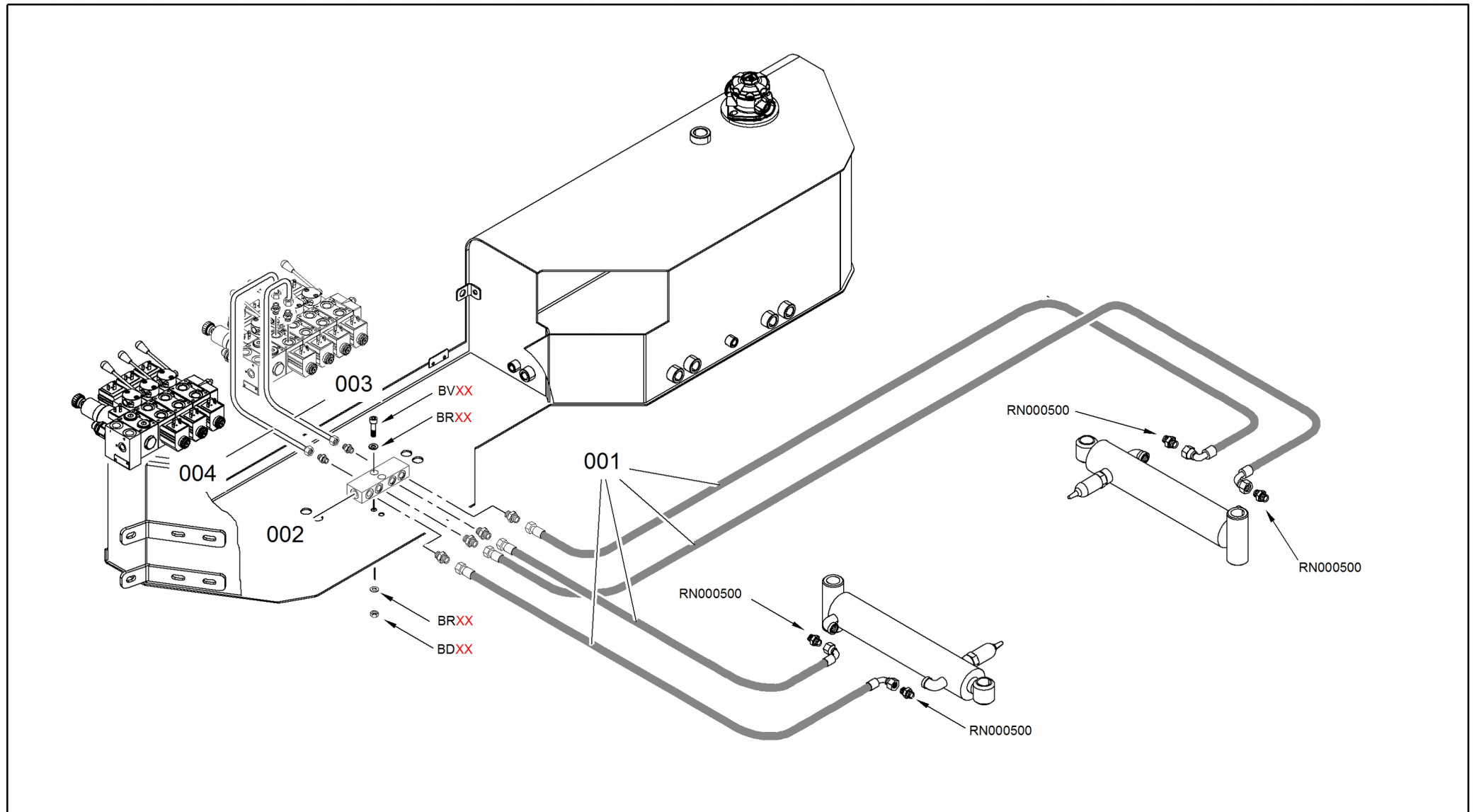
 HYDRAULIKANLAGE VERBREITERUNG WAGEN  
 INSTALACIÓN HIDRAULICA ENSANCHAMIENTO CARRO



Main color codes:  J1 - JLG Cream,  J2 - JLG Orange,  C4 - Green







 IMPIANTO IDRAULICO ALLARGAMENTO CARRO



HYDRAULIKANLAGE VERBREITERUNG WAGEN 



 HYDRAULIC SYSTEM UNDERCARRIAGE EXPANSION

INSTALACIÓN HIDRAULICA ENSANCHAMIENTO CARRO 



 SYSTÈME HYDRAULIQUE EXTENSION DU CHARIOT

POS	Codice	 Descrizione	 Description	 Designation	 Benennung	 Descripción
1	07628800	TUBO FLESSIBILE	FLEXIBLE PIPE	TUYAU FLEXIBLE	SCHLAUCH	TUBO FLEXIBLE
2	04707700	COLLETTORE	MANIFOLD	COLLECTEUR	KOLLEKTOR	COLECTOR
3	07581400	TUBO RIGIDO	RIGID PIPE	TUYAU RIGIDE	ROHR	TUBO RÍGIDO
4	07581500	TUBO RIGIDO	RIGID PIPE	TUYAU RIGIDE	ROHR	TUBO RÍGIDO

 IMPIANTO IDRAULICO CILINDRI STABILIZZATORI  
 STABILIZERS CYLINDERS HYDRAULIC SYSTEM  
 INSTALLATION HYDRAULIQUE CYLINDRES STABILISATERS

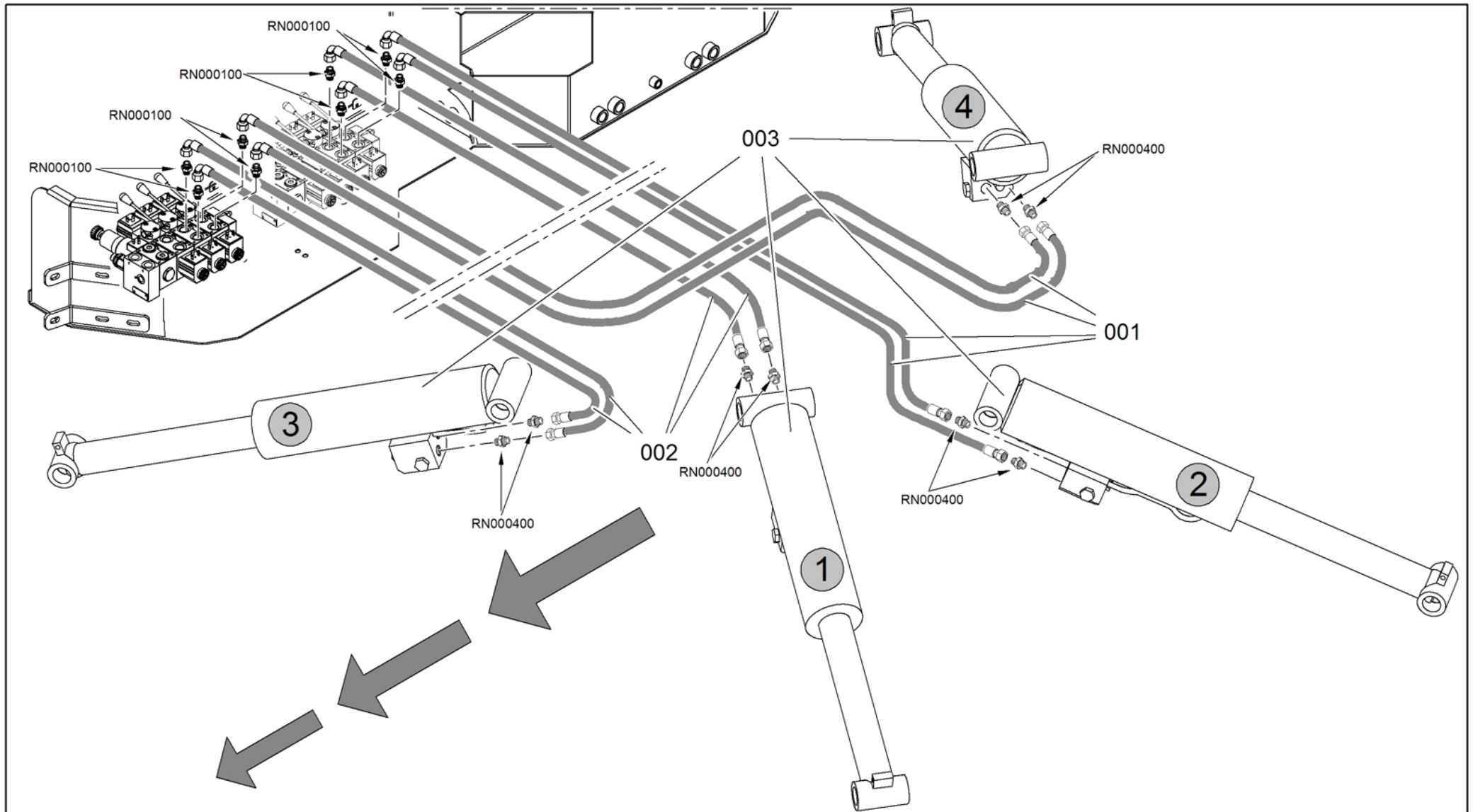
ABSTÜTZUNGSZYLINDER ABSTÜTZUNGSHYDRAULIKZYLINDER   
INSTALACIÓN HIDRAULICA CILINDROS ESTABILIZADORS 



Main color codes:  J1 - JLG Cream,  J2 - JLG Orange,  C4 - Green





 IMPIANTO IDRAULICO CILINDRI STABILIZZATORI



 STABILIZERS CYLINDERS HYDRAULIC SYSTEM

 INSTALLATION HYDRAULIQUE CYLINDRES STABILISATERS

ABSTÜTZUNGZYLINDER ABSTÜTZUNGSHYDRAULIKZYLINDER 

INSTALCIÓN HIDRAULICA CILINDROS ESTABILIZADORS 

POS	Codice	 Descrizione	 Description	 Designation	 Benennung	 Descripción
1	07628600	TUBO FLESSIBILE	FLEXIBLE PIPE	TUYAU FLEXIBLE	SCHLAUCH	TUBO FLEXIBLE
2	07628700	TUBO FLESSIBILE	FLEXIBLE PIPE	TUYAU FLEXIBLE	SCHLAUCH	TUBO FLEXIBLE
3	275870A3	CILINDRO STABILIZZATORE	OUTRIGGER CYLINDER	CYLINDRE STABILISATEUR	STÜTZBEINZYLINDER	CILINDRO ESTABILIZADOR
3	275870H2	CILINDRO STABILIZZATORE	OUTRIGGER CYLINDER	CYLINDRE STABILISATEUR	STÜTZBEINZYLINDER	CILINDRO ESTABILIZADOR

Main color codes:  J1 - JLG Cream,  J2 - JLG Orange,  C4 - Green

 IMPIANTO IDRAULICO 1 - 2 BRACCIO



 1-2 ARMS HYDRAULIC SYSTEM

 SYSTÈME HYDRAULIQUE 1-2 BRAS

HYDRAULIKANLAGE 1-2 ARM 

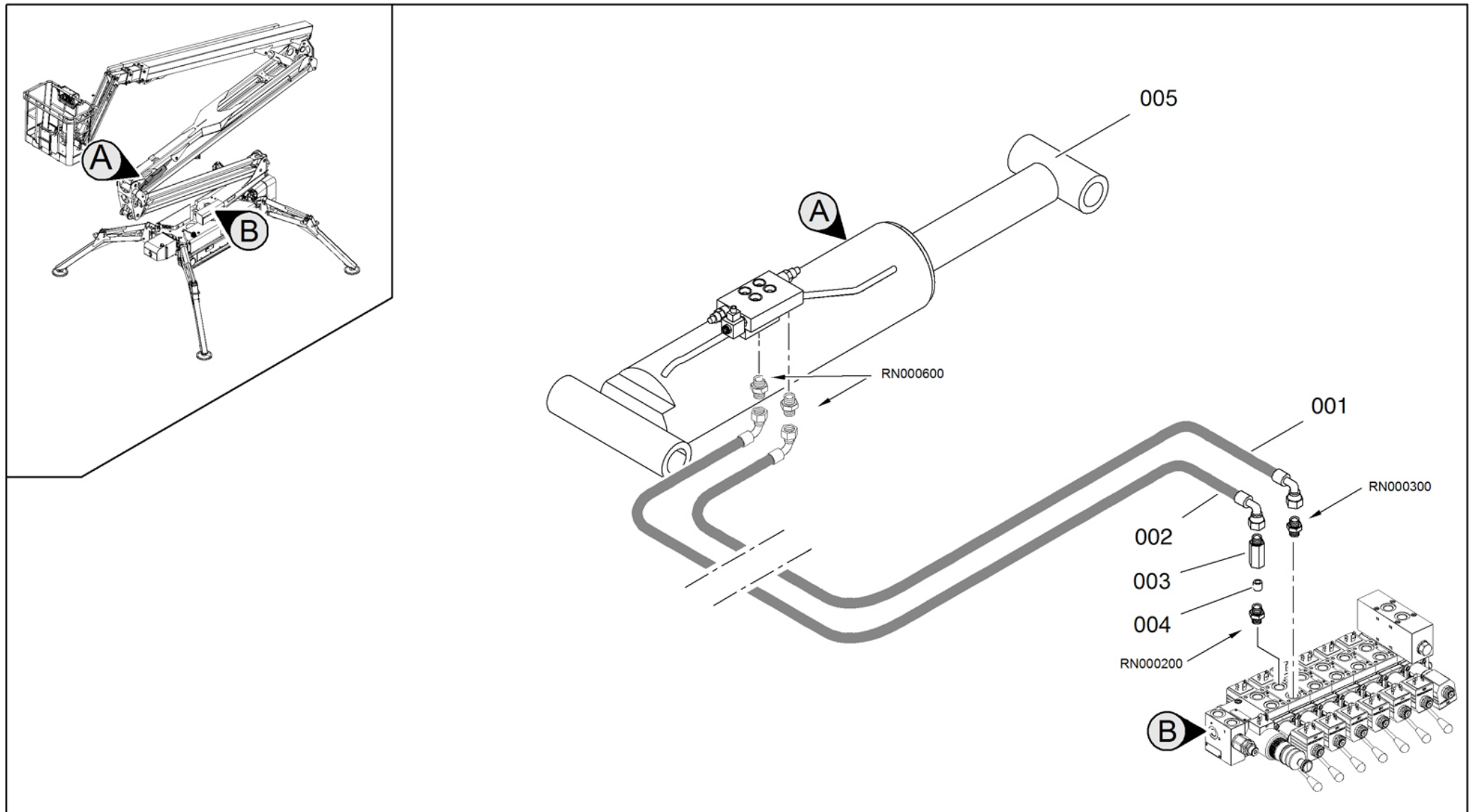
INSTALACIÓN HIDRÁULICA 1-2 BRAZOS 











Main color codes:  J1 - JLG Cream,  J2 - JLG Orange,  C4 - Green



 IMPIANTO IDRAULICO 1 - 2 BRACCIO



 1-2 ARMS HYDRAULIC SYSTEM

 SYSTÈME HYDRAULIQUE 1-2 BRAS
HYDRAULIKANLAGE 1-2 ARM INSTALACIÓN HIDRÁULICA 1-2 BRAZOS 



POS	Codice	 Descrizione	 Description	 Designation	 Benennung	 Descripción
1	07630100	TUBO FLESSIBILE	FLEXIBLE PIPE	TUYAU FLEXIBLE	SCHLAUCH	TUBO FLEXIBLE
2	07630200	TUBO FLESSIBILE	FLEXIBLE PIPE	TUYAU FLEXIBLE	SCHLAUCH	TUBO FLEXIBLE
3	07688400	RACCORDO PROLUNGA M-F 3/8 H=30 FILETTO UTILE 25	FITTING	RACCORD	ANSCHLUSS	CONEXIÓN
4	07688500	PASTIGLIA VNR STROZZATA 3/8 FORO DA Ø=2MM	VALVE	SOUPAPE	VENTIL	VALVULA
5	275200A3	CILINDRO 1° E 2° BRACCIO	FIRST AND SECOND ARM CYLINDER	CYLINDRE 1ER ET 2ÈME BRAS	ZYLINDER 1. U. 2. ARM	CILINDRO PRIMERO Y SEGUNDO BRAZO
5	275200H2	CILINDRO 1° E 2° BRACCIO	FIRST AND SECOND ARM CYLINDER	CYLINDRE 1ER ET 2ÈME BRAS	ZYLINDER 1. U. 2. ARM	CILINDRO PRIMERO Y SEGUNDO BRAZO

Main color codes:  J1 - JLG Cream,  J2 - JLG Orange,  C4 - Green

 IMPIANTO IDRAULICO 3 BRACCIO  
 3 ARM HYDRAULIC SYSTEM  
 SYSTÈME HYDRAULIQUE 3 BRAS

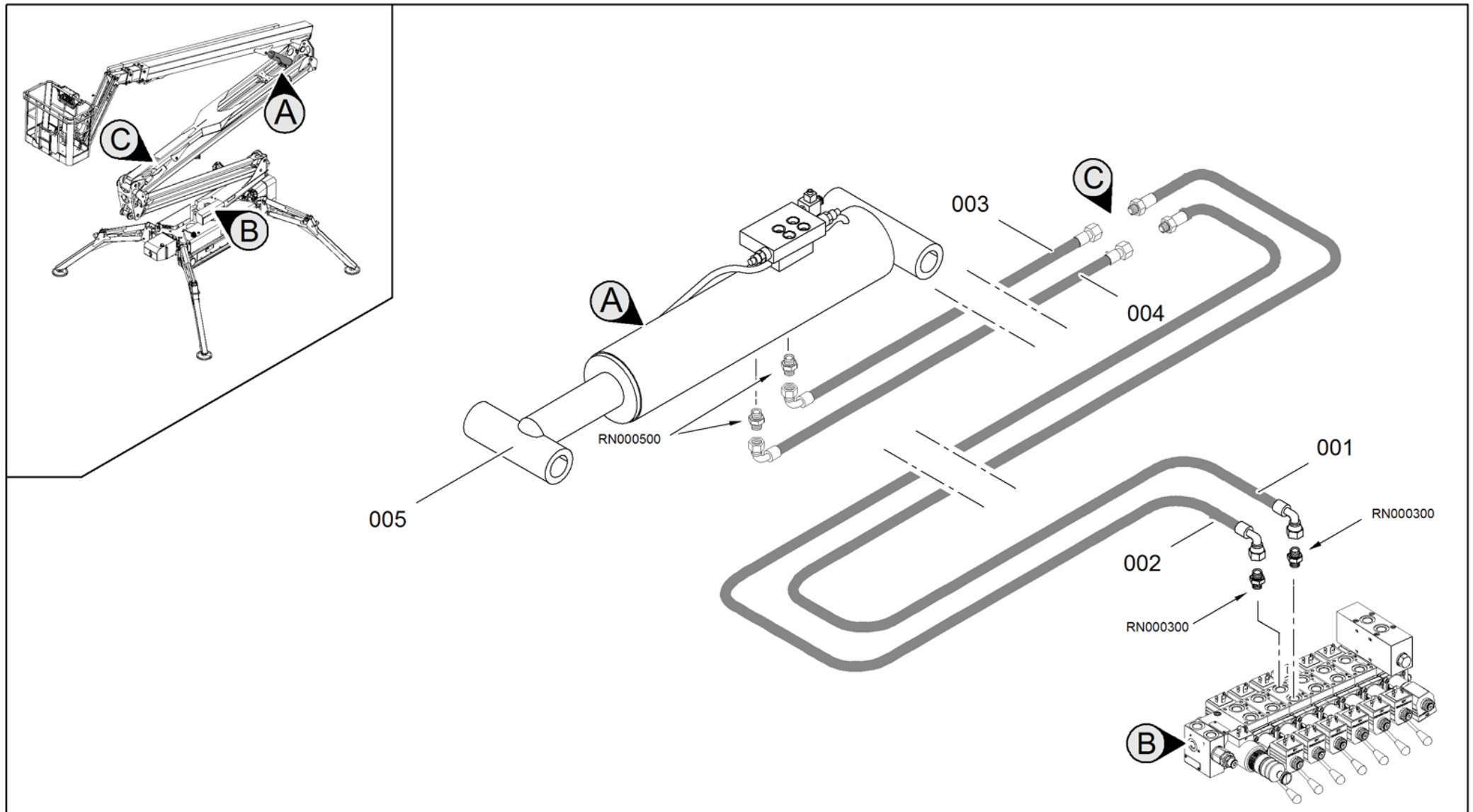
HYDRAULIKANLAGE 3 ARM   
 INSTALACIÓN HIDRÁULICA 3 BRAZO 







Main color codes:  J1 - JLG Cream,  J2 - JLG Orange,  C4 - Green









 IMPIANTO IDRAULICO 3 BRACCIO

 3 ARM HYDRAULIC SYSTEM

 SYSTÈME HYDRAULIQUE 3 BRAS
HYDRAULIKANLAGE 3 ARM INSTALACIÓN HIDRÁULICA 3 BRAZO 



POS	Codice	 Descrizione	 Description	 Designation	 Benennung	 Descripción
1	07630700	TUBO FLESSIBILE	FLEXIBLE PIPE	TUYAU FLEXIBLE	SCHLAUCH	TUBO FLEXIBLE
2	07630900	TUBO FLESSIBILE	FLEXIBLE PIPE	TUYAU FLEXIBLE	SCHLAUCH	TUBO FLEXIBLE
3	07630800	TUBO FLESSIBILE	FLEXIBLE PIPE	TUYAU FLEXIBLE	SCHLAUCH	TUBO FLEXIBLE
4	07631000	TUBO FLESSIBILE	FLEXIBLE PIPE	TUYAU FLEXIBLE	SCHLAUCH	TUBO FLEXIBLE
5	275201A3	CILINDRO 3° BRACCIO	THIRD ARM CYLINDER	CYLINDRE 3ÈME BRAS	ZYLINDER 3. ARM	CILINDRO TERCERO BRAZO
5	275201H2	CILINDRO 3° BRACCIO	THIRD ARM CYLINDER	CYLINDRE 3ÈME BRAS	ZYLINDER 3. ARM	CILINDRO TERCERO BRAZO
5	283894H2	CILINDRO 3° BRACCIO	THIRD ARM CYLINDER	CYLINDRE 3ÈME BRAS	ZYLINDER 3. ARM	CILINDRO TERCERO BRAZO

Main color codes:  J1 - JLG Cream,  J2 - JLG Orange,  C4 - Green

 IMPIANTO IDRAULICO SFILLO  
 TELESCOPIC HYDRAULIC SYSTEM  
 TELESCOPIQUE HIDRAULIQUE

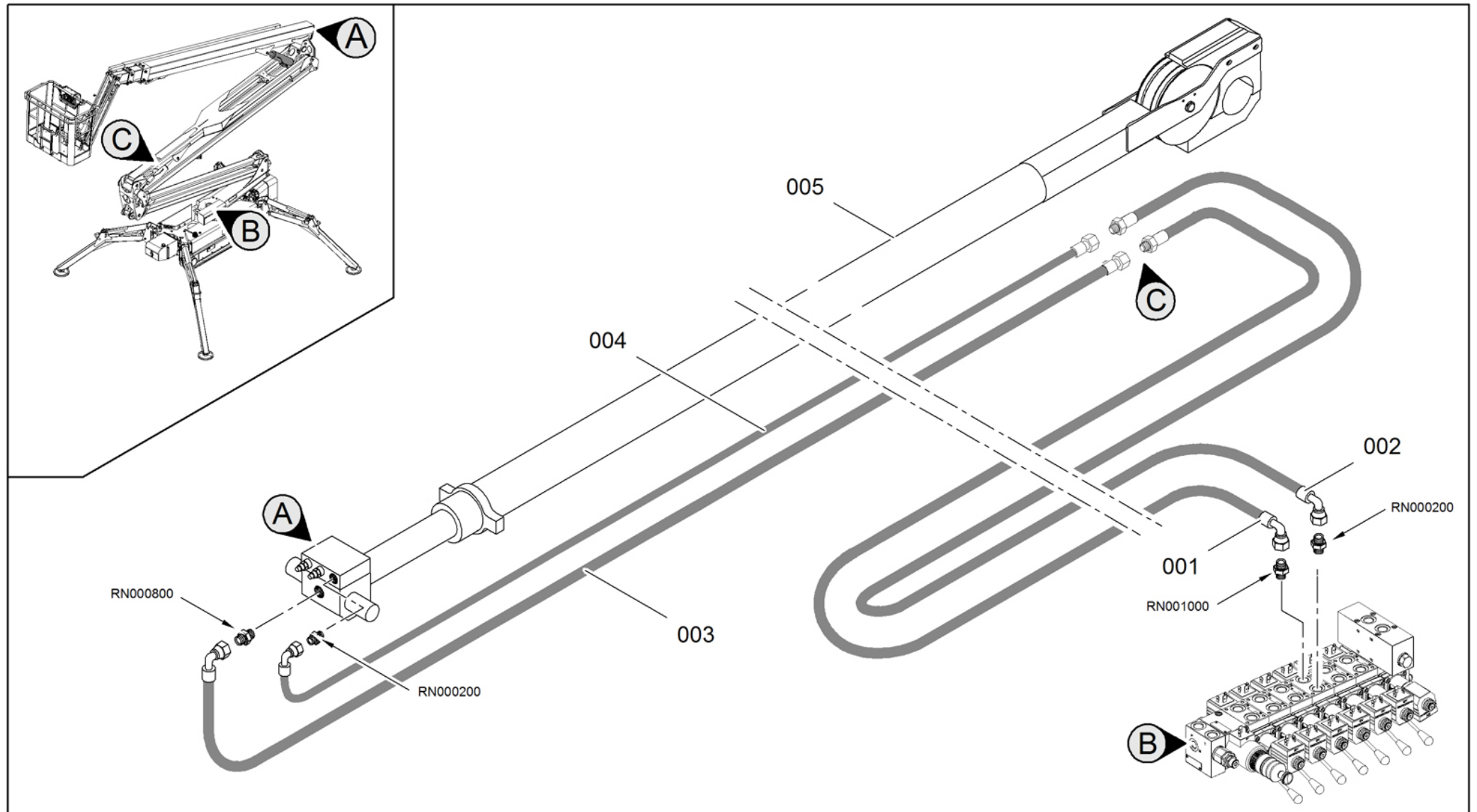
TELESKOPHYDRAULIK   
 INSTALACIÓN EXTENSIÓN HIDRÁULICA 



Main color codes:  **J1** - JLG Cream,  **J2** - JLG Orange,  **C4** - Green





 IMPIANTO IDRAULICO SFILO



 TELESCOPIC HYDRAULIC SYSTEM



 TELESCOPIQUE HIDRAULIQUE

 TELESKOPHYDRAULIK



 INSTALACIÓN EXTENSIÓN HIDRÁULICA

POS	Codice	 Descrizione	 Description	 Designation	 Benennung	 Descripción
1	07631100	TUBO FLESSIBILE	FLEXIBLE PIPE	TUYAU FLEXIBLE	SCHLAUCH	TUBO FLEXIBLE
2	07631300	TUBO FLESSIBILE	FLEXIBLE PIPE	TUYAU FLEXIBLE	SCHLAUCH	TUBO FLEXIBLE
3	07631200	TUBO FLESSIBILE	FLEXIBLE PIPE	TUYAU FLEXIBLE	SCHLAUCH	TUBO FLEXIBLE
3	08394400	TUBO FLESSIBILE	FLEXIBLE PIPE	TUYAU FLEXIBLE	SCHLAUCH	TUBO FLEXIBLE
4	07631400	TUBO FLESSIBILE	FLEXIBLE PIPE	TUYAU FLEXIBLE	SCHLAUCH	TUBO FLEXIBLE
5	275202H2	CILINDRO SFILO	EXTENSION CYLINDER	CYLINDRE BRAS D'EXTRACTION	ZYLINDER TELESKOPAUSSCHUB	CILINDRO EXTENSION
5	283859H2	CILINDRO SFILO LL2614 CON SENSORE HINOWA GRAY	CYLINDER LL 2614 WITH SENSOR HINOWA GRAY	CYLINDRE LL2614 AVEC CAPTEUR GRIS HINOWA	ZYLINDER LL 2614 MIT SENSOR HINOWA GRAU	CILINDRO LL 2614 CON SENSOR HINOWA GRIS

 IMPIANTO JIB  
 JIB HYDRAULIC SYSTEM  
 SYSTÈME HYDRAULIQUE JIB

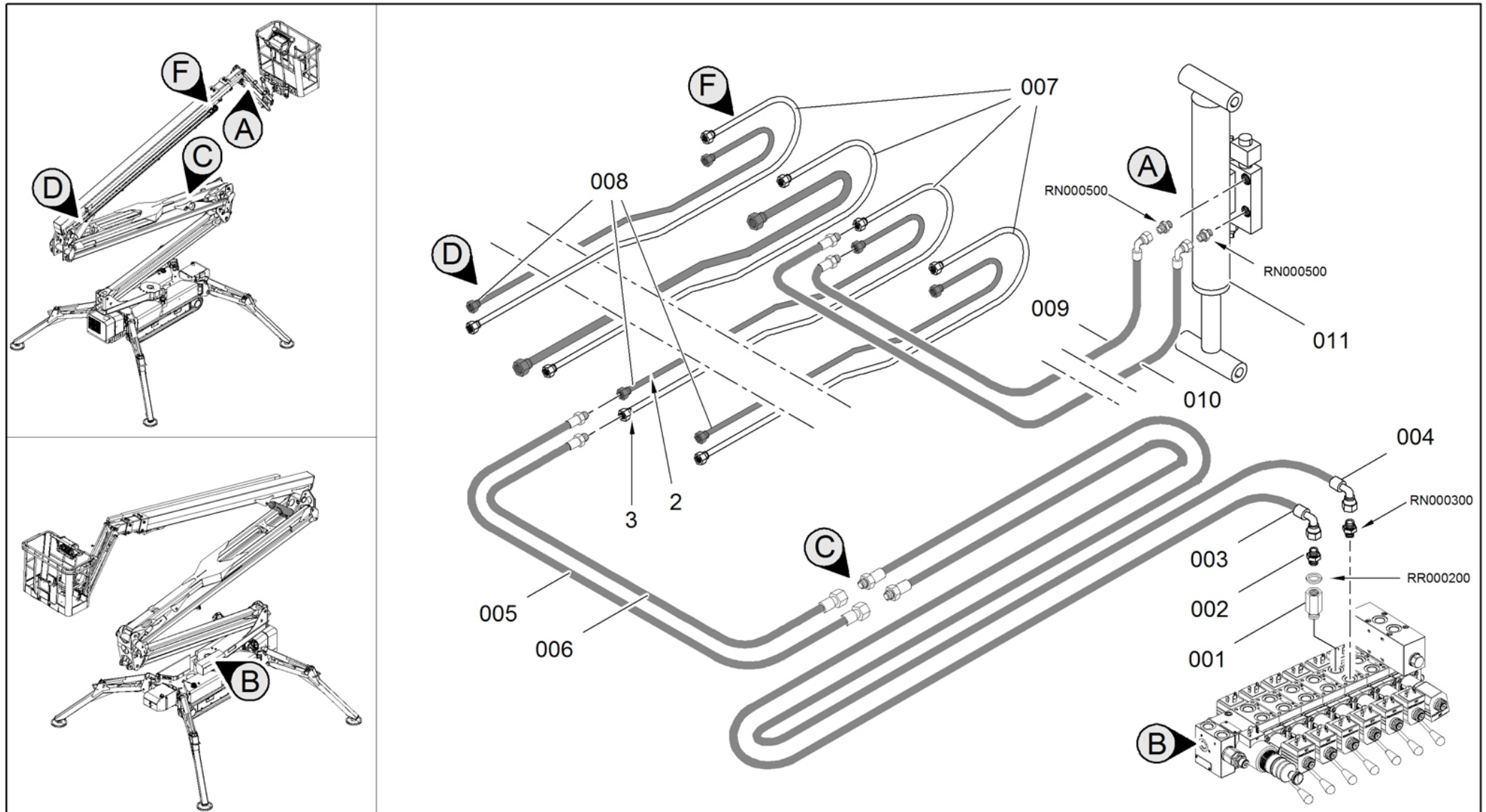
ZYLINDER JIB ARM   
 INSTALCIÓN HIDRÁULICA JIB 



**Main color codes:**  J1 - JLG Cream,  J2 - JLG Orange,  C4 - Green





 IMPIANTO JIB



 JIB HYDRAULIC SYSTEM



 SYSTÈME HYDRAULIQUE JIB

 ZYLINDER JIB ARM



 INSTALACIÓN HIDRÁULICA JIB

POS	Codice	 Descrizione	 Description	 Designation	 Benennung	 Descripción
1	RS000700	RIDUZIONE M-F GAS 1" * 1/2"	REDUCING GAS M-F 1 " * 1/2"	RÉDUCTION M-F GAS 1" * 1/2"	REDUZIERUNG GAS M-F 1" * 1/2"	REDUCCIÓN M-F GAS 1" * 1/2"
2	06786700	RACCORDO	FITTING	RACCORD	ANSCHLUSS	CONEXIÓN
3	07631900	TUBO FLESSIBILE	FLEXIBLE PIPE	TUYAU FLEXIBLE	SCHLAUCH	TUBO FLEXIBLE
4	07632100	TUBO FLESSIBILE	FLEXIBLE PIPE	TUYAU FLEXIBLE	SCHLAUCH	TUBO FLEXIBLE
5	07632000	TUBO FLESSIBILE	FLEXIBLE PIPE	TUYAU FLEXIBLE	SCHLAUCH	TUBO FLEXIBLE
6	07632200	TUBO FLESSIBILE	FLEXIBLE PIPE	TUYAU FLEXIBLE	SCHLAUCH	TUBO FLEXIBLE
7	07539500	TUBO RIGIDO	RIGID PIPE	TUYAU RIGIDE	ROHR	TUBO RÍGIDO
8	07539600	TUBO RIGIDO	RIGID PIPE	TUYAU RIGIDE	ROHR	TUBO RÍGIDO
9	07603400	TUBO FLESSIBILE	FLEXIBLE PIPE	TUYAU FLEXIBLE	SCHLAUCH	TUBO FLEXIBLE
10	07603500	TUBO FLESSIBILE	HOSE	TUYAU FLEXIBLE	SCHLAUCH	TUBO FLEXIBLE
11	270695A3	CILINDRO SFILO	EXTENSION CYLINDER	CYLINDRE SECT.TÉLESCOP.	TELESKOPZYLINDER	CIL. BRAZO TELESCÓP.
11	270695H2	CILINDRO JIB	JIB CYLINDER	CYLINDRE JIB	KORBARMZYLINDER	CILINDRO JIB

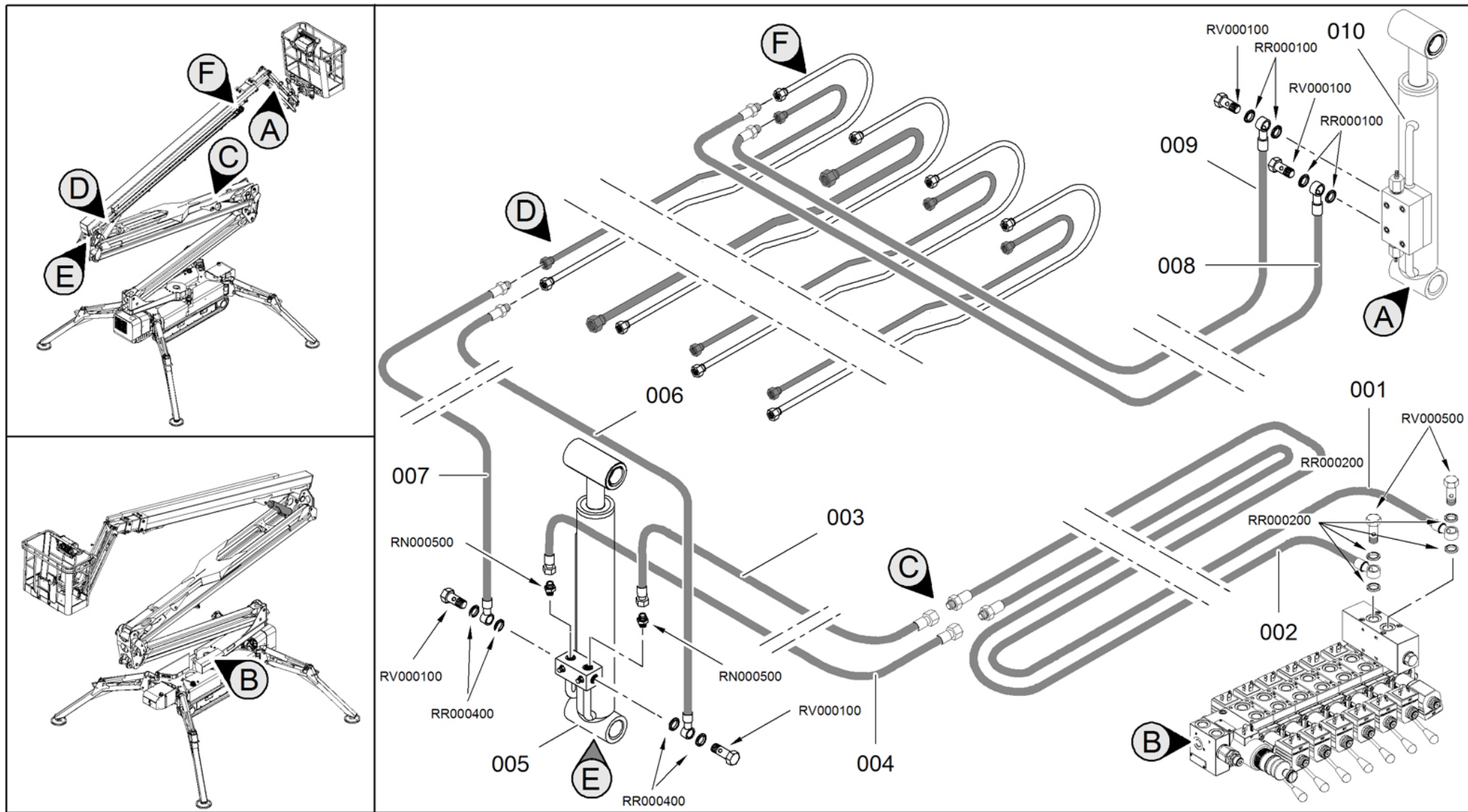

 IMPIANTO IDRAULICO LIVELLAMENTO  
 LEVELING CYLINDERS HYDRAULIC SYSTEM  
 SYSTÈME HYDRAULIQUE CYLINDRES BRAS



HYDRAULIKANLAGE ZYLINDER ARM   
 INSTALACIÓN HIDRÁULICA CILINDROS BRAZOS 











Main color codes:  J1 - JLG Cream,  J2 - JLG Orange,  C4 - Green





 IMPIANTO IDRAULICO LIVELLAMENTO  
 LEVELING CYLINDERS HYDRAULIC SYSTEM  
 SYSTÈME HYDRAULIQUE CYLINDRES BRAS



HYDRAULIKANLAGE ZYLINDER ARM   
 INSTALACIÓN HIDRÁULICA CILINDROS BRAZOS 

POS	Codice	 Descrizione	 Description	 Designation	 Benennung	 Descripción
1	07630300	TUBO FLESSIBILE	FLEXIBLE PIPE	TUYAU FLEXIBLE	SCHLAUCH	TUBO FLEXIBLE
2	07630500	TUBO FLESSIBILE	FLEXIBLE PIPE	TUYAU FLEXIBLE	SCHLAUCH	TUBO FLEXIBLE
3	07630400	TUBO FLESSIBILE	FLEXIBLE PIPE	TUYAU FLEXIBLE	SCHLAUCH	TUBO FLEXIBLE
4	07630600	TUBO FLESSIBILE	FLEXIBLE PIPE	TUYAU FLEXIBLE	SCHLAUCH	TUBO FLEXIBLE
5	270693A3	CILINDRO SFILO	EXTENSION CYLINDER	CYLINDRE SECT.TÉLESCOP.	TELESKOPZYLINDER	CIL. BRAZO TELESCÓP.
5	270693H2	CILINDRO LIVELLAMENTO CESTO	BASKET LEVELLING CYLINDER	CYLINDRE NIVELLEMENT PANIER	ZYLINDER KORBNIVELLIERUNG	CILINDRO NIVELACIÓN CESTA
6	07632700	TUBO FLESSIBILE	FLEXIBLE PIPE	TUYAU FLEXIBLE	SCHLAUCH	TUBO FLEXIBLE
7	07632800	TUBO FLESSIBILE	FLEXIBLE PIPE	TUYAU FLEXIBLE	SCHLAUCH	TUBO FLEXIBLE
8	07603300	TUBO FLESSIBILE	HOSE	TUYAU FLEXIBLE	SCHLAUCH	TUBO FLEXIBLE
9	07603600	TUBO FLESSIBILE	HOSE	TUYAU FLEXIBLE	SCHLAUCH	TUBO FLEXIBLE
10	273151A3	CILINDRO LIVELLAMENTO CESTO SU CESTO	CYLINDER LEVEL BASKET ON BASKET	CYLINDRE SUR LEVEL BASKET BASKET	ZYLINDER AUF LEVEL WARENKORB WARENKORB	CILINDRO DE NIVEL DE BASKET BASKET
10	273151H2	CILINDRO LIVELLAMENTO CESTO SU CESTO	LEVELING CYLINDER BASKET ON BASKET	CYLINDRE NIVELLEMENT PANIER SUR PANIER	ZYLINDER KORBNIVELLIERUNG	CILINDRO NIVELACIÓN CESTA

 IMPIANTO IDRAULICO ROTAZIONE CESTO  
 CAGE ROTATION HYDRAULIC SYSTEM  
 SYSTÈME HYDRAULIQUE ROTATION PANIER

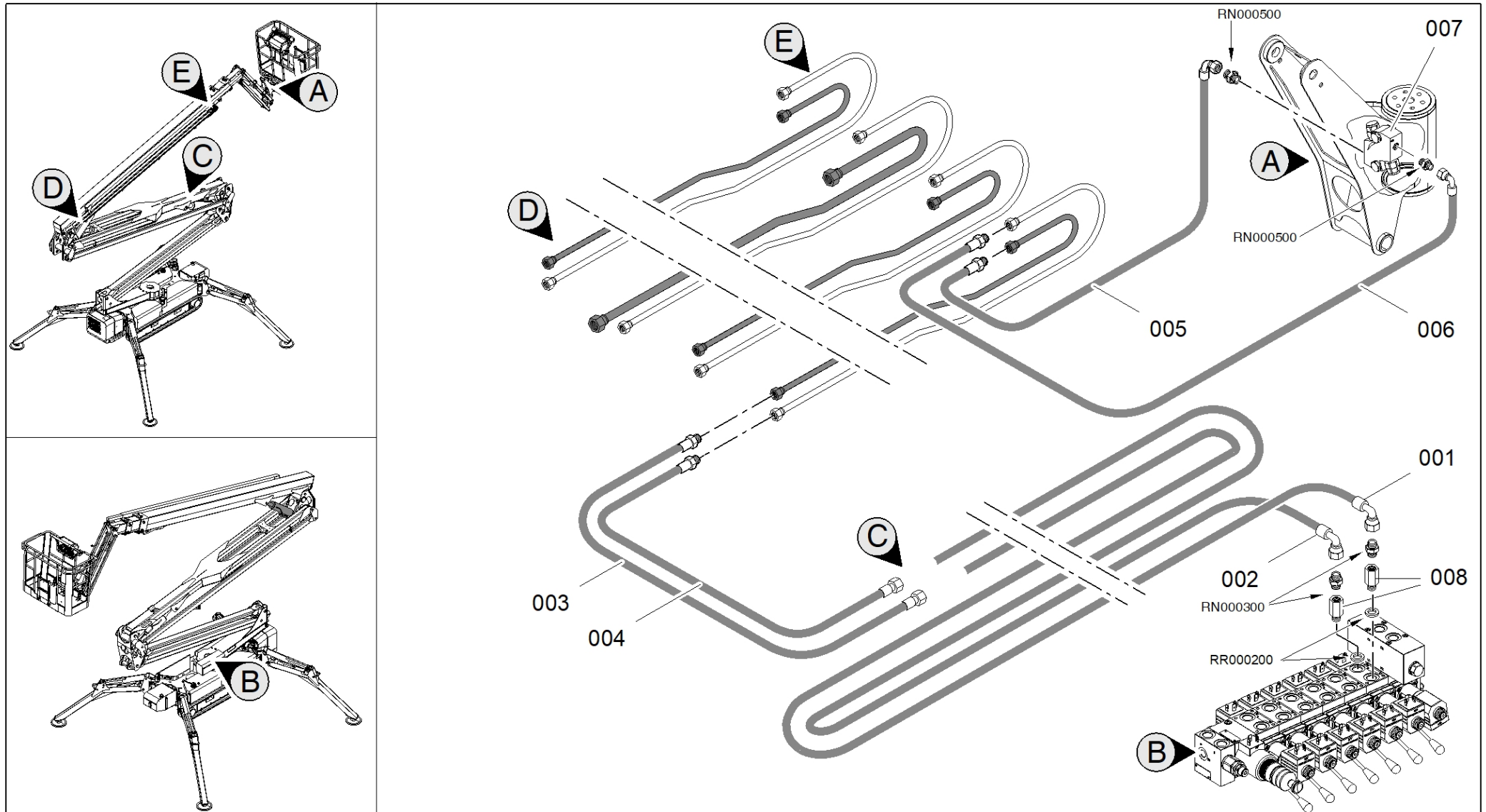
HYDRAULIKANLAGE KORBSCHWENKUNG   
 INSTALACIÓN HIDRÁULICA ROTACIÓN CESTA 









Main color codes:  J1 - JLG Cream,  J2 - JLG Orange,  C4 - Green



 IMPIANTO IDRAULICO ROTAZIONE CESTO



 CAGE ROTATION HYDRAULIC SYSTEM



 SYSTÈME HYDRAULIQUE ROTATION PANIER

 HYDRAULIKANLAGE KORBSCHWENKUNG   
 INSTALACIÓN HIDRÁULICA ROTACIÓN CESTA 



POS	Codice	 Descrizione	 Description	 Designation	 Benennung	 Descripción
1	07632300	TUBO FLESSIBILE	FLEXIBLE PIPE	TUYAU FLEXIBLE	SCHLAUCH	TUBO FLEXIBLE
2	07632500	TUBO FLESSIBILE	FLEXIBLE PIPE	TUYAU FLEXIBLE	SCHLAUCH	TUBO FLEXIBLE
3	07632400	TUBO FLESSIBILE	FLEXIBLE PIPE	TUYAU FLEXIBLE	SCHLAUCH	TUBO FLEXIBLE
4	07632600	TUBO FLESSIBILE	FLEXIBLE PIPE	TUYAU FLEXIBLE	SCHLAUCH	TUBO FLEXIBLE
5	07603800	TUBO FLESSIBILE	HOSE	TUYAU FLEXIBLE	SCHLAUCH	TUBO FLEXIBLE
6	07603900	TUBO FLESSIBILE	TUBO FLEXIBLE	TUYAU FLEXIBLE	SCHLAUCH	TUBO FLEXIBLE
7	2648910001	VALVOLA IDRAULICA	HYDRAULIC VALVE	VALVE HYDRAULIQUE	HYDRAULIKVENTIL	VÁLVULA HIDRÁULICA
8	03149500	RACCORDO A COLONNA 3/8" H=20	EXTENSION 3/8" H=20	RACCORD	ANSCHLUSS	CONEXIÓN

 Main color codes:  J1 - JLG Cream,  J2 - JLG Orange,  C4 - Green

 IMPIANTO IDRAULICO ARIA COMPRESSA  
 COMPRESSED AIR HYDRAULIC SYSTEM  
 SYSTÈME HYDRAULIQUE AIR COMPRIMÉ

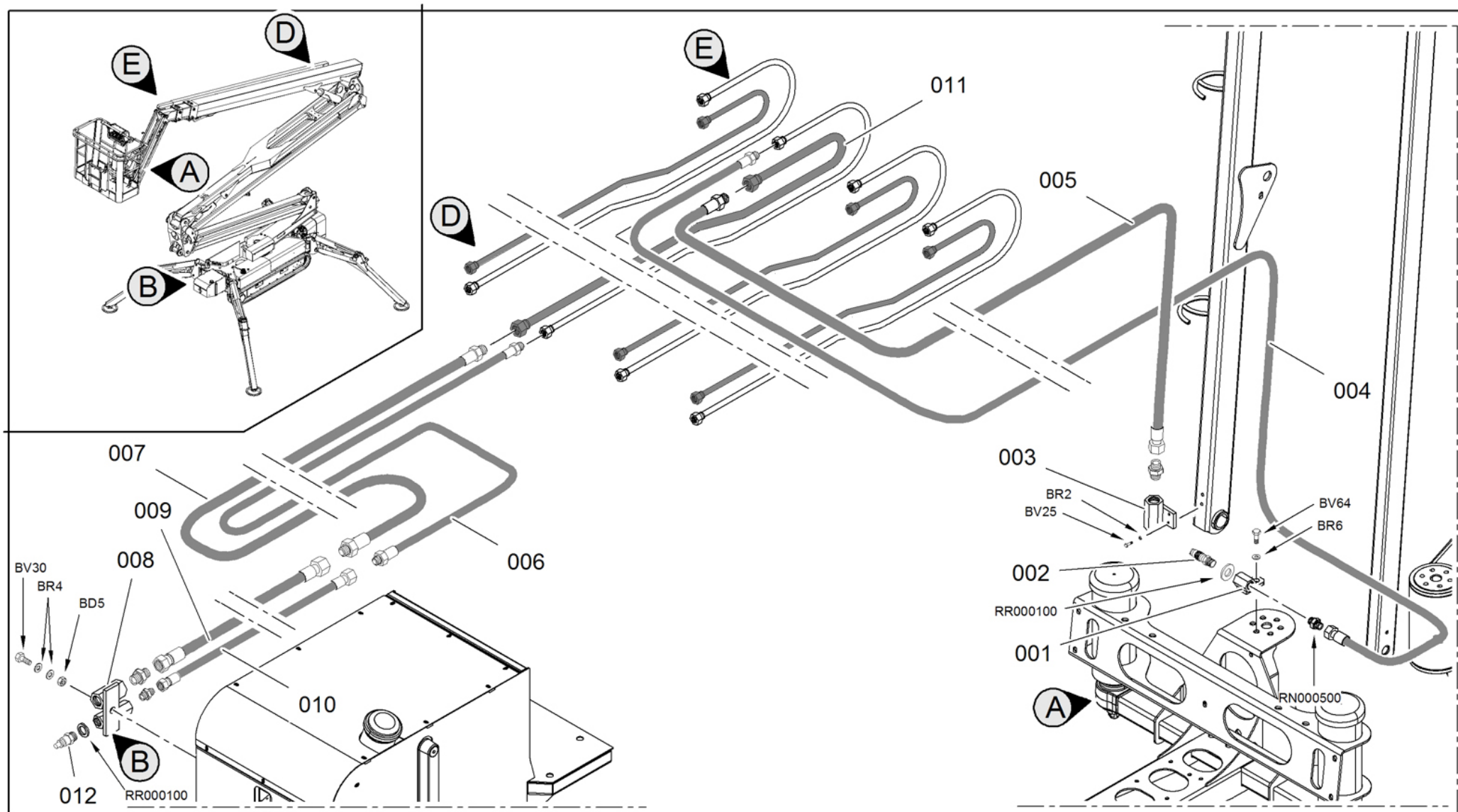
HYDRAULIKANLAGE DRUCKLUFT   
 INSTALACIÓN HIDRÁULICA AIRE COMPRIMIDO 



Main color codes:  J1 - JLG Cream,  J2 - JLG Orange,  C4 - Green





 IMPIANTO IDRAULICO ARIA COMPRESSA

 HYDRAULIKANLAGE DRUCKLUFT

 COMPRESSED AIR HYDRAULIC SYSTEM



 INSTALACIÓN HIDRÁULICA AIRE COMPRIMIDO

 SYSTÈME HYDRAULIQUE AIR COMPRIMÉ

POS	Codice	 Descrizione	 Description	 Designation	 Benennung	 Descripción
1	04845100	SUPPORTO	SUPPORT	SUPPORT	HALTERUNG	SOPORTE
2	05580200	RUBINETTO	FAUCET	ROBINET	WASSERHAHN	GRIFO
3	07611100	RACCORDO	HOSE FITTING	TUYAU	ANSCHLUSS	CONEXIÓN
4	07603700	TUBO FLESSIBILE	HOSE	TUYAU FLEXIBLE	SCHLAUCH	TUBO FLEXIBLE
5	07604000	TUBO FLESSIBILE	FLEXIBLE PIPE	TUYAU FLEXIBLE	SCHLAUCH	TUBO FLEXIBLE
6	07631800	TUBO FLESSIBILE	FLEXIBLE PIPE	TUYAU FLEXIBLE	SCHLAUCH	TUBO FLEXIBLE
7	07631600	TUBO FLESSIBILE	FLEXIBLE PIPE	TUYAU FLEXIBLE	SCHLAUCH	TUBO FLEXIBLE
8	07611000	RACCORDO	PIPE FITTING	TUYAU	ANSCHLUSS	MANGUITO
9	07631500	TUBO FLESSIBILE	FLEXIBLE PIPE	TUYAU FLEXIBLE	SCHLAUCH	TUBO FLEXIBLE
10	07631700	TUBO FLESSIBILE	FLEXIBLE PIPE	TUYAU FLEXIBLE	SCHLAUCH	TUBO FLEXIBLE
11	07530700	TUBO RIGIDO	RIGID PIPE	TUYAU RIGIDE	ROHR	TUBO RÍGIDO
12	05509900	INNESTO RAPIDO	QUICK COUPLING	RACCORD RAPIDE	SCHNELLKUPPLUNG	CONEXIÓN RÁPIDA





 CILINDRI  
 CYLINDERS  
 CYLINDRES

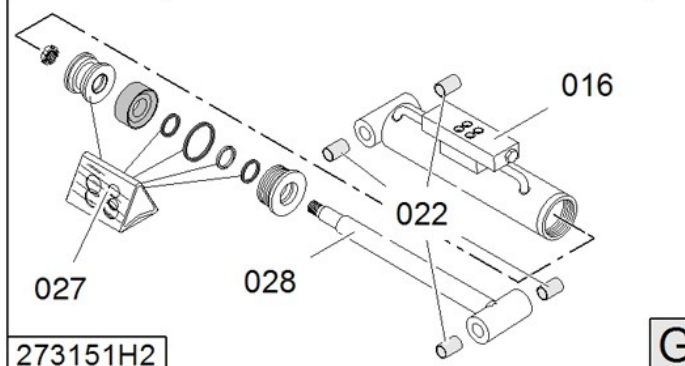
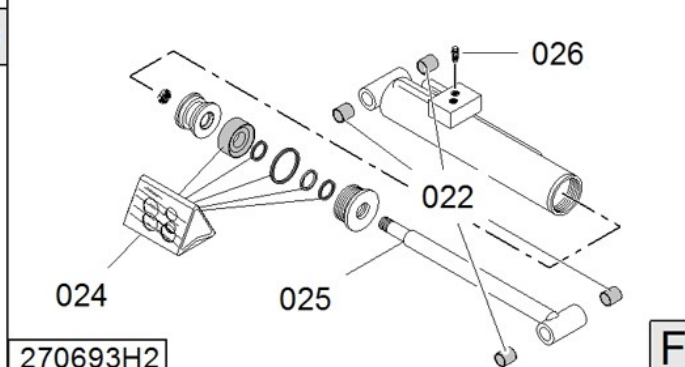
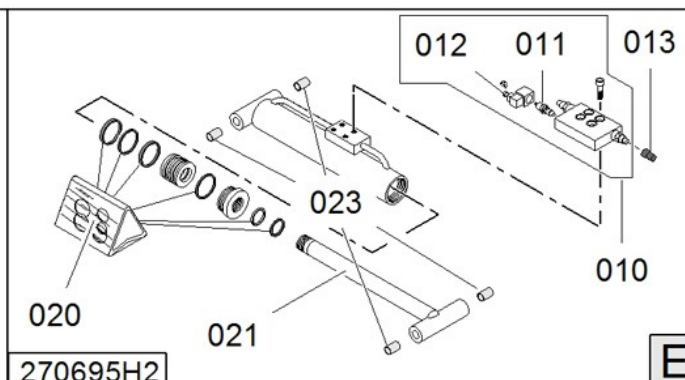
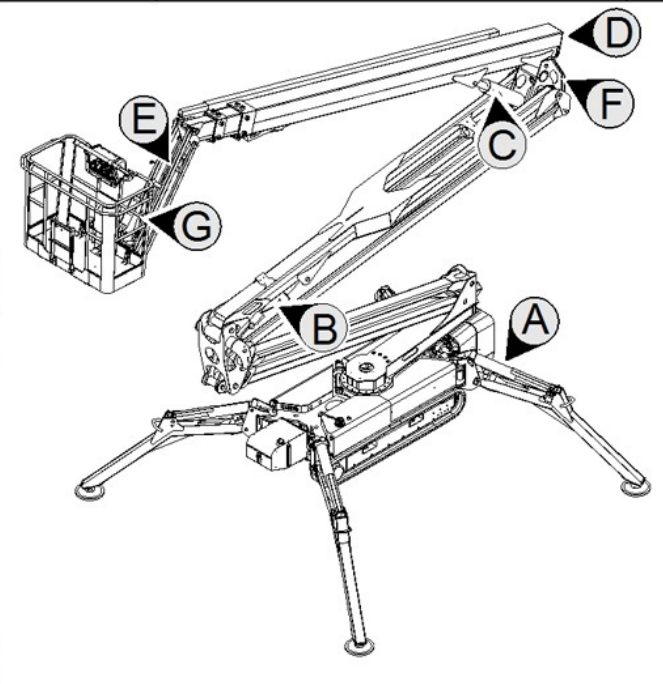
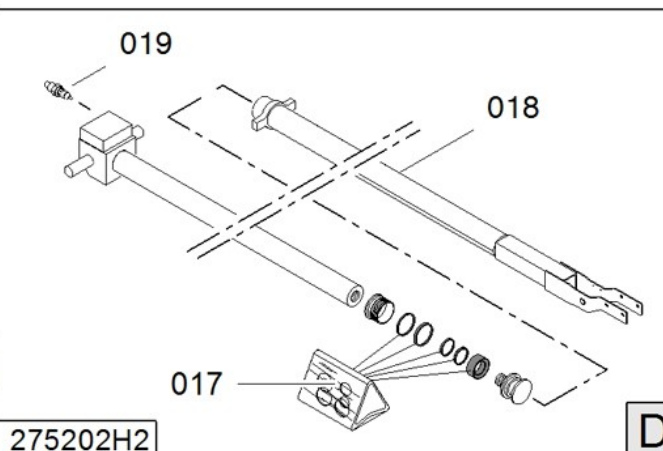
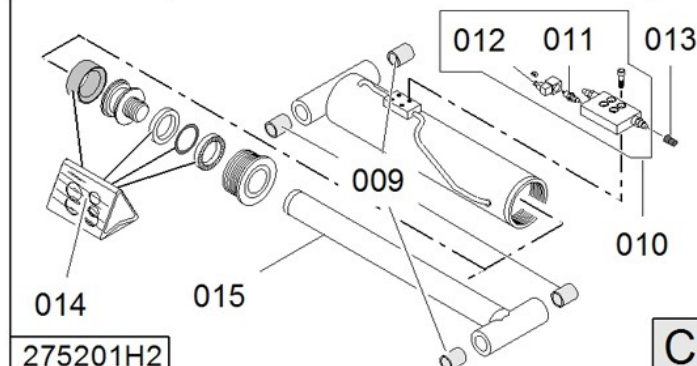
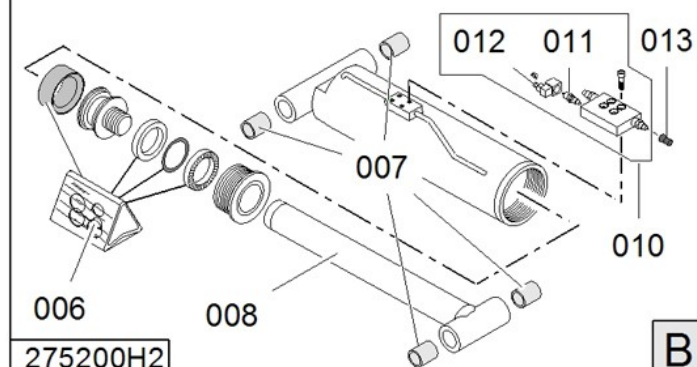
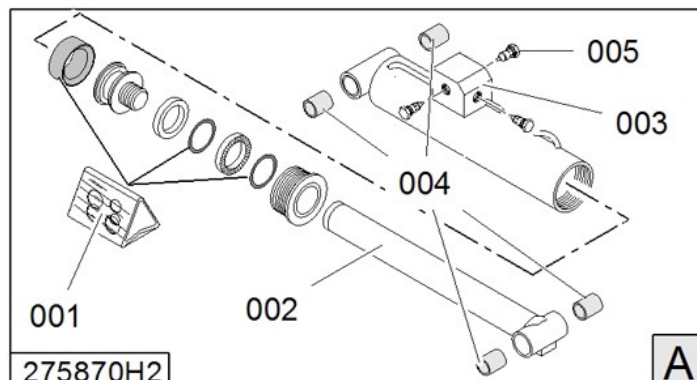



ZYLINDER   
 CILINDROS 









 CILINDRI  
 CYLINDERS  
 CYLINDRES





ZYLINDER   
 CILINDROS 

POS	Codice	 Descrizione	 Description	 Designation	 Benennung	 Descripción
1	2758700002	KIT GUARNIZIONI CILINDRO STABILIZZATORE LL2614	SEALING KIT	KIT JOINTS	DICHTSATZ	KIT JUNTAS
2	2758700001	STELO CILINDRO STABILIZZATORE LL2614	CYLINDER ROD	TIGE CYLINDRE	ZYLINDERSCHAFT	VÁSTAGO CILINDRO
3	2705540002	BLOCCHETTO	BLOCK	BLOC	BLOCK	BLOQUE
4	2627880005	BOCCOLA	BUSH	DOUILLE	BUCHSE	CASQUILLO
5	1541150011	VALVOLA IDRAULICA	HYDRAULIC VALVE	VALVE HYDRAULIQUE	HYDRAULIKVENTIL	VÁLVULA HIDRÁULICA
6	2752000003	KIT GUARNIZIONI CILINDRO 1-2 BRACCIO LL2614	SEALING KIT CYLINDER 1-2 BOOM LL2614-X26JP-X770AJ	KIT DE JOINTS	DICHTSATZ	KIT JUNTAS
7	2752000001	BOCCOLA AUTOLUBRIFICANTE TIPO MLG 45X50 L=45 GLACIER	BUSH	DOUILLE	BUCHSE	CASQUILLO
8	2752000002	STELO	ROD	TIGE	SCHAFT	VÁSTAGO
8	2752000004	SENSORE LINEARE CON LETTURA 510MM	SENSOR LINEAR WITH RANGE 510MM	CAPTEUR	SENSOR	SENSOR
9	2752010001	BOCCOLA AUTOLUBRIFICANTE TIPO MLG 40X45 L=40 GLACIER	BUSH	DOUILLE	BUCHSE	CASQUILLO
10	26119300	VALVOLA IDRAULICA	HYDRAULIC VALVE	VALVE HYDRAULIQUE	HYDRAULIKVENTIL	VÁLVULA HIDRÁULICA
11	0552550001	ELETTROVALVOLA	SOLENOID VALVE	ÉLECTROVANNE	MAGNETVENTIL	ELECTROVÁLVULA
12	0552550003	BOBINA	COIL	BOBINE	SPULE	BOBINA
13	05576200	PROTEZIONE	PROTECTION	PROTECTION	SCHUTZ	PROTECCIÓN
14	2752010003	KIT GUARNIZIONI CILINDRO 3 BRACCIO LL2614	SEAL KIT	KIT DE JOINTS	DICHTSATZ	KIT JUNTAS
15	2752010002	STELO	ROD	TIGE	SCHAFT	VÁSTAGO



Main color codes:  J1 - JLG Cream,  J2 - JLG Orange,  C4 - Green

 CILINDRI  
 CYLINDERS  
 CYLINDRES



ZYLINDER   
 CILINDROS 

POS	Codice	 Descrizione	 Description	 Designation	 Benennung	 Descripción
15	2752010004	SENSORE LINEARE CON LETTURA 495MM	SENSOR LINEAR WITH RANGE 495MM	CAPTEUR	SENSOR	SENSOR
16	2731510003	VALVOLA IDRAULICA	HYDRAULIC VALVE	VALVE HYDRAULIQUE	HYDRAULIKVENTIL	VÁLVULA HIDRÁULICA
17	2752020001	KIT GUARNIZIONI	GASKET KIT	KIT JOINTS	DICHTUNGSSATZ	KIT GUARNICIONES
18	2752020002	STELO	ROD	TIGE	SCHAFT	VÁSTAGO
19	2630690003	VALVOLA IDRAULICA	HYDRAULIC VALVE	VALVE HYDRAULIQUE	HYDRAULIKVENTIL	VÁLVULA HIDRÁULICA
19	2838590001	VALVOLA BILANCIAMENTO DOPPIA CON DISCESA DI EMERGENZA CILINDRO SFILO LL2614MK2- EDI	DOUBLE BALANCING VALVE WITH EMERGENCY LOWERING CYLINDER EXHAUST LL2614MK2- EDI	VALVE D'EQUILIBRAGE	DOPPEL AUSGLEICHSVENTIL	VALVULA DE EQUILIBRIO DOBLE
20	2706950001	KIT GUARNIZIONI CILINDRO JIB	SEAL KIT CYLINDER JIB	KIT DE JOINTS	DICHTUNGSSATZ	KIT JUNTAS CILINDRO JIB
21	2706950002	STELO CILINDRO JIB	ROD CYLINDER JIB	TIGE DE CYLINDRE JIB	KORBARM ZYLINDERSCHAFT	VASTAGO CILINDRO JIB
22	2627890006	BOCCOLA	BUSH	DOUILLE	BUCHSE	CASQUILLO
23	2627910006	BOCCOLA	BUSH	DOUILLE	BUCHSE	CASQUILLO
24	2706930001	KIT GUARNIZIONI CILINDRO LIVELLAMENTO SU RINVIO	CYLINDER GASKET KIT	KIT DE JOINTS CYLINDRE NIVELLEMENT	DICHTSATZ ZYLINDER AUSNIVELLIERUNG	KIT DE JUNTAS CILINDRO NIVELACIÓN
25	2706930002	STELO CILINDRO LIVELLAMENTO SU RINVIO	ROD CYLINDER	TIGE CYLINDRE	ZYLINDERSCHAFT	VASTAGO CILINDRO
26	2588290008	VITE	SCREW	VIS	SCHRAUBE	TORNILLO
27	2706940001	KIT GUARNIZIONI CILINDRO LIVELLAMENTO SU CESTO	CYLINDER GASKET KIT	KIT DE JOINTS CYLINDRE NIVELLEMENT	DICHTSATZ	KIT JUNTAS

 CILINDRI  
 CYLINDERS  
 CYLINDRES



ZYLINDER   
 CILINDROS 

POS	Codice	 Descrizione	 Description	 Designation	 Benennung	 Descripción
28	2706940002	STELO CILINDRO LIVELLAMENTO SU CESTO	BASKET LEVELING CYLINDER ROD ON BASKET	CYLINDRE TIGE	ZYLINDERSCHAFT	VASTAGO CILINDRO

 COMPONENTI IMPIANTO ELETTRICO  
 ELECTRICAL SYSTEM COMPONENTS  
 COMPOSANTS INSTALLATION ÉLECTRIQUE

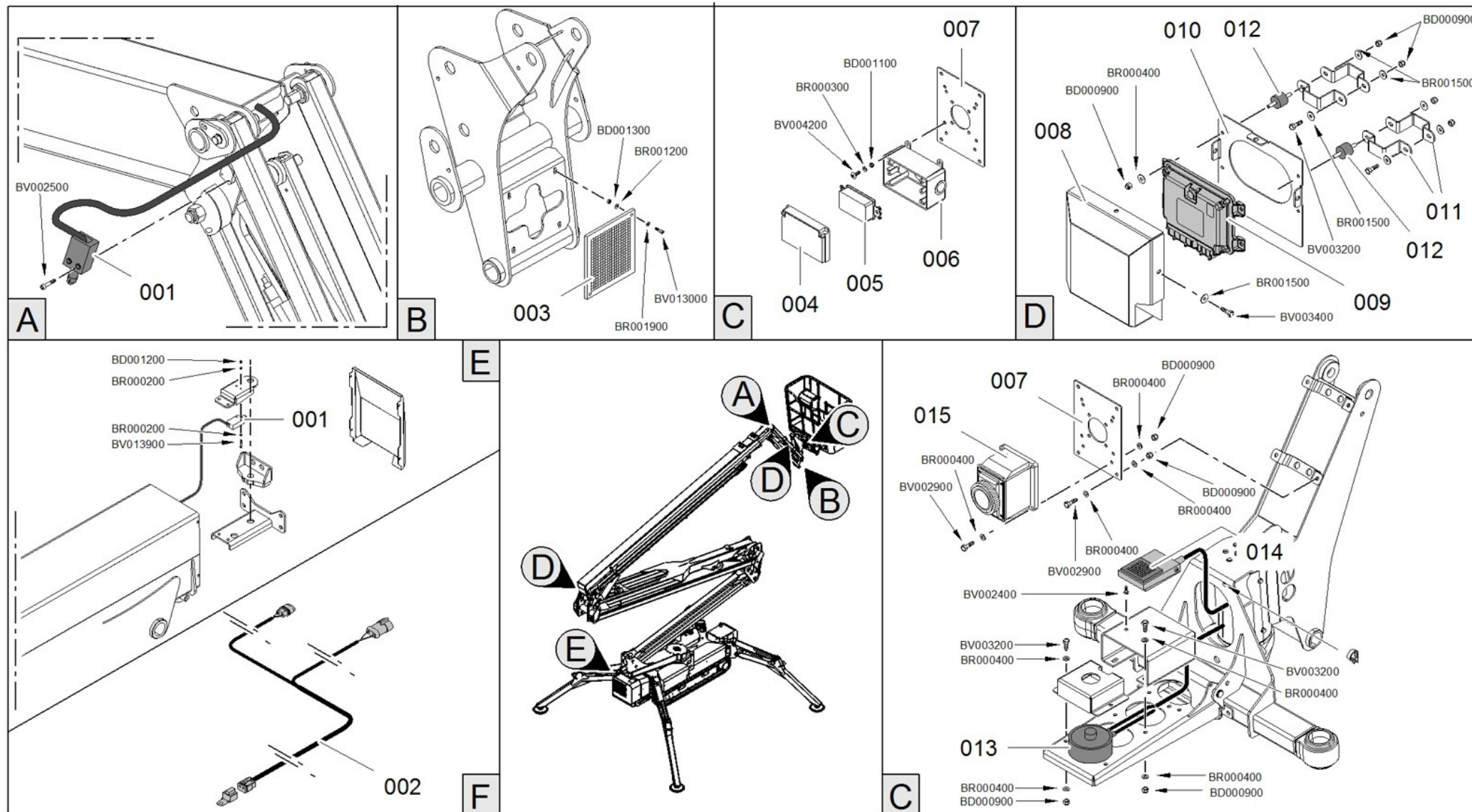
KOMPONENTEN ELEKTROANLAGE   
 COMPONENTES INSTALACIÓN ELÉCTRICA 









Main color codes:  J1 - JLG Cream,  J2 - JLG Orange,  C4 - Green

 COMPONENTI IMPIANTO ELETTRICO

 ELECTRICAL SYSTEM COMPONENTS

 COMPOSANTS INSTALLATION ÉLECTRIQUE



 KOMponenten Elektroanlage   
 Componentes Instalación Eléctrica 





POS	Codice	 Descrizione	 Description	 Designation	 Benennung	 Descripción
1	1679900012	MICROINTERRUTTOR E 2 CONTATTI NC/NO TESTINA ROTELLA ACCIAIO CAVO LUNGO 5 METRI	MICRO SWITCH CONTACT 2 NC / NO HEAD STEEL WHEEL LONG CABLE 5 METER	MICROINTERRUPTEUR	MIKROSCHALTER	MICROINTERRUPTOR
3	1679890001	CATARIFRANGENTE 100X100 MM	REFLECTOR 100X100 MM	CATADIOPTRE	REFLEKTOR	CATADIÓPTRICO
4	27073800	COVER PRESE USA AL CESTO, RECEPTACLE BOX PART N°:1671207	COVER US SOCKETS TO BASKET, RECEPTACLE BOX PART N°:1671207	PRETECTION	SCHUTZ	PROTECCIÓN
5	27073900	PLUG PRESE USA AL CESTO, RECEPTACLE PART N°:4460346	US SOCKETS TO BASKET, RECEPTACLE PART N°:4460346	PRISE	STECKDOSE	ENCHUFE
6	27073700	BOX PRESE USA AL CESTO, RECEPTACLE PART N°:0861731	US SOCKET BOX TO BASKET, RECEPTACLE PART N°:0861731	BOX PRISES	SCHACHTEL STECKDOSEN	CAJA ENCHUFES
7	077089A6	PIASTRA FISSAGGIO PRESE SU CESTO TTC	FIXING PLATE PLUGS ON BASKET TTC	PLAQUE	PLATTE	PLACA
7	077089H2	PIASTRA FISSAGGIO PRESE SU CESTO TTC	FIXING PLATE PLUGS ON BASKET TTC	PLAQUE	PLATTE	PLACA
8	077092A6	CARTER PROTEZIONE SCHEDELLA DI CARICO TTC HINOWA GREY	PROTECTION	PROTECTION	SCHUTZ	PROTECCION
8	077092H2	CARTER PROTEZIONE SCHEDELLA DI CARICO TTC HINOWA GREY	PROTECTION	PROTECTION	SCHUTZ	PROTECCION



 COMPONENTI IMPIANTO ELETTRICO

 ELECTRICAL SYSTEM COMPONENTS

 COMPOSANTS INSTALLATION ÉLECTRIQUE





 KOMponenten Elektroanlage   
 Componentes Instalación Eléctrica 



POS	Codice	 Descrizione	 Description	 Designation	 Benennung	 Descripción
9	1772950016	SCHEDA 48XS CON BOOTLOADER 1.2.0, VERSIONE SOFTWARE PER MACCHINE CE E ANSI CON MOTORE TERMICO E LITIO	X48S BOARD WITH BOOTLOADER 1.2.0, SOFTWARE VERSION FOR CE AND ANSI MARKET WITH ENGINE THERMIC AND LITIO	CARTE ÉLECTRONIQUE	ELEKTRONISCHE PLATINE	TARJETA ELECTRÓNICA
10	077091A6	PIASTRA FISSAGGIO SCHEDA CELLA DI CARICO TTC	FIXING PLATE LOAD CELL CARD TTC	PLAQUE	PLATTE	PLACA
10	077091H2	PIASTRA FISSAGGIO SCHEDA CELLA DI CARICO TTC	FIXING PLATE LOAD CELL CARD TTC	PLAQUE	PLATTE	PLACA
11	077090A6	COLLARE FISSAGGIO SCHEDA CELLA DI CARICO TTC	COLLAR FIXING SHEET LOAD CELL TTC	BRIDE	BUNDRING	ABRAZADERA
11	077090H2	COLLARE FISSAGGIO SCHEDA CELLA DI CARICO TTC	COLLAR FIXING SHEET LOAD CELL TTC	BRIDE	BUNDRING	ABRAZADERA
12	04152300	SUPPORTO ELASTICO SUPERIORE RADIATORE -	SPRING SUPPORT	SUPPORT ELASTIQUE	FEDERAUFLAGE	SOPORTE ELASTICO
13	17669800	SENSORE CELLA DI CARICO 4-20MA COMPLETO DI CAVO E CONNETTORI M12 (MK2)	SENSOR LOAD CELL 4-20MA WITH CABLE AND CONNECTORS M12 (MK2 VERSION)	CELLULE DE CHARGE (MK2)	MESSDOSE (MK2)	CÉLULA DE CARGA (MK2)
14	1772950015	INTERRUPTORE A PEDALE COMPLETO DI CAVO E CONNETTORE TRE VIE CONTATTO NC/NO	FOOT SWITCH COMPLETE WITH CABLE AND CONNECTOR THREE-WAY CONTACT NC/NO	INTERRUPTEUR	SCHALTER	INTERRUPTOR

 Main color codes:  J1 - JLG Cream,  J2 - JLG Orange,  C4 - Green







 COMPONENTI IMPIANTO ELETTRICO ELECTRICAL SYSTEM COMPONENTS COMPOSANTS INSTALLATION ÉLECTRIQUEKOMPONENTEN ELEKTROANLAGE COMPONENTES INSTALACIÓN ELÉCTRICA 

POS	Codice	 Descrizione	 Description	 Designation	 Benennung	 Descripción
15	1585570005	PRESA ELETTRICA 230V	ELECTRICAL SOCKET 230V	PRISE ÉLECTRIQUE	STECKDOSE	ENCHUFE ELÉCTRICO
15	1591700002	PRESA ELETTRICA 110V	ELECTRICAL SOCKET 110V	PRISE ÉLECTRIQUE 110V	STECKDOSE 110V	ENCHUFE ELÉCTRICO 110V

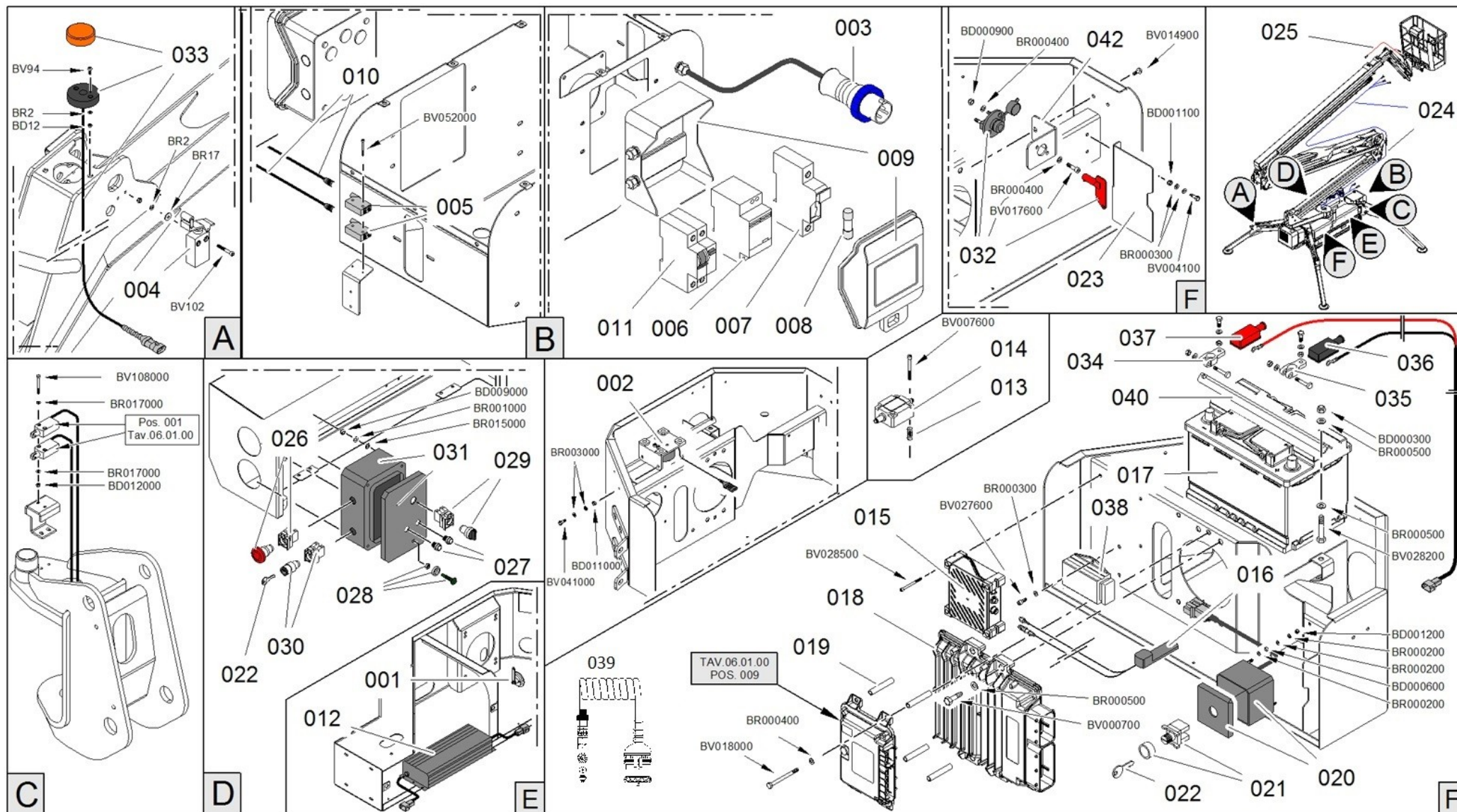
 COMPONENTI IMPAINTO ELETTRICO  
 ELECTRICAL SYSTEM COMPONENTS  
 COMPOSANTS INSTALLATION ÉLECTRIQUE

KOMPONENTEN ELEKTROANLAGE   
 COMPONENTES INSTALACIÓN ELÉCTRICA 









Main color codes:  J1 - JLG Cream,  J2 - JLG Orange,  C4 - Green



 COMPONENTI IMPAINTO ELETTRICO

 ELECTRICAL SYSTEM COMPONENTS

 COMPOSANTS INSTALLATION ÉLECTRIQUE

 KOMponenten Elektroanlage   
 Componentes Instalación Eléctrica 



POS	Codice	 Descrizione	 Description	 Designation	 Benennung	 Descripción
1	04834500	CLAXON 12V	HORN	KLAXON	HORN	BOCINA
2	06639100	AVVISATORE ACUSTICO	ACOUSTIC ALARM	BUZZER	SUMMER	ZUMBADOR
3	1757250001	SPINA VOLANTE 230V 16A	FREE PLUG 230V 16A	FICHE	STECKER	ENCHUFE
3	1757250002	SPINA VOLANTE 110V 32A	FREE PLUG 110V 32A	CHEVILLE	STIF	CLAVIJA
3	1757250003	SPINA VOLANTE 110V 16A	FREE PLUG 110V 16A	CHEVILLE	STIF	CLAVIJA
3	27074000	TERMINAL PRESA USA A TERRA, CONN PLUG PART N°:4460138	TERMINAL GROUND SOCKET USA, CONN PLUG PART N°: 4460138	CONNECTEUR	VERBINDER	CONECTOR
4	1770740001	MICROINTERRUPTOR E 2 CONTATTI NC/NO TESTINA BRACCIO E ROTELLA IN ACCIAIO CAVO LUNGO 2 METRI	2 NC/NO CONTACTS MICROSWITCH HEAD ARM AND WHEEL STEEL LONG CABLE 2M	MICROINTERRUPTEUR	MIKROSCHALTER	MICROINTERRUPTOR
5	1591270001	FOTOCPELLULA	PHOTOCELL	CELLULE PHOTO-ÉLECTRIQUE	PHOTOZELLE	FOTOCÉLULA
6	1757250006	TELERUTTORE 4POLI 63A CA/CC	RELAY	RELAIS	RELAIS	RELÉ
7	1730720015	PORTAFUSIBILE A TUBO 220/110V	FUSE HOLDER TUBE 220/110V	BOÎTE À FUSIBLES	SICHERUNGSKASTEN	PORTAFUSIBLES
8	1730720017	FUSIBILE A TUBO 10A	TUBE FUSE 10A	FUSIBLE	SICHERUNG	FUSIBLE
9	1757250008	SCATOLA ELETTRICO PLASTICA 6 MODULI BI COPERCHIO TRASPARENTE	ELECTRICAL BOX	BOÎTE ÉLECTRIQUE	SCHALTKASTEN	CAJA ELÉCTRICA
10	159127000101	CAVO ELETTRICO	ELECTRIC CABLE	CÂBLE ÉLECTRIQUE	ELEKTROKABEL	CABLE ELÉCTRICO





 Main color codes:  J1 - JLG Cream,  J2 - JLG Orange,  C4 - Green



 COMPONENTI IMPAINTO ELETTRICO

 ELECTRICAL SYSTEM COMPONENTS

 COMPOSANTS INSTALLATION ÉLECTRIQUE

 KOMONENTEN ELEKTROANLAGE   
 COMPONENTES INSTALACIÓN ELÉCTRICA 



POS	Codice	 Descrizione	 Description	 Designation	 Benennung	 Descripción
11	1556350063	INTERUTTORE AUTOMATICO MAGNETOTERMICO 110-120V 25A (FINO A C170000355 MONTATO C16 SU MACCHINE 120V)	AUTOMATIC THERMAL SWITCH 110-120V 25A (UNTIL C170000355 MOUNTED C16 ON 120V MACHINES)	INTERRUPTEUR	SCHALTER	INTERRUPTOR
12	1757250007	ALIMENTATORE ELETTRONICO 285W REGOLABILE IP65 PER BATTERIE 55-75 AH COMPLETO DI CONNETTORI	ELECTRONIC BALLAST	ALIMENTATEUR ÉLECTRONIQUE	ELEKTRONISCHES NETZGERÄT	ALIMENTADOR ELETRÓNICO
12	1757260008	CABLAGGIO DA BATTERIA A CARICABATTERIA CON DIODO E CONNETTORE	WIRING FROM BATTERY TO CHARGER WITH DIODE AND CONNECTOR	CÂBLAGE	VERKABELUNG	CABLEADO
12	17572600081	CONNETTORE DEUTSCH 2 VIE COMPLETO DI DIODO CON PROTEZIONE	DEUTSCH CONNECTOR 2 WAYS OF COMPLETE WITH PROTECTION DIODE	CONNECTEUR	VERBINDER	CONECTOR
13	05444800	MOLLA	SPRING	RESSORT	FEDER	MUELLE
14	17708000	INCLINOMETRO	INCLINOMETER	INCLINOMÈTRE	NEIGUNGSSENSOR	INCLINÓMETRO
15	1772950017	MODEM ESTERNO GPS-4G CAN PROGRAMMATO PER GESTIONE A RICAMBIO	MODEM GPS-4G CAN TO SPARE	MODEM	MODEM	MODEM
15	18359800	PROLUNGA CONNESSIONE MODEM TTC WAVE	TTC WAVE MODEM CONNECTION EXTENSION	RALLONGE	VERLÄNGERUNG	ALARGADERA
15	18448000	SCHEDA MODEM 4G CE-AUSTRALIA	MODEM BOARD 4G CE-AUSTRALIA	CARTE MODEM 4G CE-AUSTRALIA	PLATINE MODEM 4G CE-AUSTRALIA	PLACA MODEM 4G CE-AUSTRALIA





 Main color codes:  J1 - JLG Cream,  J2 - JLG Orange,  C4 - Green



 COMPONENTI IMPAINTO ELETTRICO

 ELECTRICAL SYSTEM COMPONENTS

 COMPOSANTS INSTALLATION ÉLECTRIQUE

 KOMponenten Elektroanlage   
 Componentes Instalación Eléctrica 



POS	Codice	 Descrizione	 Description	 Designation	 Benennung	 Descripción
15	1844800001	SCHEDE MODEM 4G CE-AUSTRALIA	MODEM BOARD 4G CE-AUSTRALIA	CARTE MODEM 4G CE-AUSTRALIA	PLATINE MODEM 4G CE-AUSTRALIA	PLACA MODEM 4G CE-AUSTRALIA
15	26582800	ADATTATORE PCAN-USB (IPEH-002021)	ADAPTER	ADAPTEUR	ADAPTER	ADAPTADOR
16	27396100	ANTENNA	AERIAL	ANTENNE	ANTENNE	ANTENA
16	28448200	ANTENNA 4G/LTE-2G/3G+GPS/GLO L=150 CONNETTORI FAKRA PER MODEM TTC	AERIAL	LTE + GPS / GLO ANTENNA L = 150 FAKRA CONNECTORS FOR TTC MODEM	ANTENNE	ANTENA
17	27599000	BATTERIA	BATTERY	BATTERIE	BATTERIE	BATERÍA
17	27668600	BATTERIA AGM S&S 12V 60AH 680A L02	BATTERY AGM S&S 12V 60AH 680A L02	BATTERIE AGM S&S 12V 60AH 680A L02	BATTERIE AGM S&S 12V 60AH 680A L02	BATERÍA AGM S&S 12V 60AH 680A L02
18	07844200	RESISTENZA 120 OHM PER CONNETTORE SERIALE RS-232	120 OHM RESISTANCE FOR CONNECTOR RS-232	120 OHM RESISTANCE POUR CONNECTEUR RS-232	120 OHM WIDERSTAND FÜR VERBINDER RS-232	RESISTENCIA 120 OHM PARA CONECTOR RS-232
18	17162400	KIT RAMHINO	RAMHINO KIT	KIT RAMHINO	KIT RAMHINO	KIT RAMHINO
18	17162500	CAVO RAMHINO SCHALTBAU	CAVO RAMHINO SCHALTBAU	CÂBLE	KABEL	CABLE
18	1787280015	SCHEDE MASTER X580 UNIVERSALE VERSIONE SOFTWARE INSTALLATO	MASTER BOARD X580 UNIVERSAL COMPATIBILITIES, SOFTWARE READY	CARTE ÉLECTRONIQUE	ELEKTRONISCHE PLATINE	TARJETA ELECTRÓNICA
18	18218600	RAMHINO CABLE TOOL ODU	RAMHINO CABLE TOOL ODU	CÂBLE	KABEL	CABLE
18	18247700	KIT RAMHINO UNIVERSALE	RAMHINO KIT UNIVERSAL	KIT RAMHINO	KIT RAMHINO	KIT RAMHINO
18	26582800	ADATTATORE PCAN-USB (IPEH-002021)	ADAPTER	ADAPTEUR	ADAPTER	ADAPTADOR
19	077087Y2	DISTANZIALE FISSAGGIO SCHEDE CELLA (ZINCATO)	SPACER	ENTRETOISE	DISTANZSTÜCK	DISTANCIADOR





 Main color codes:  J1 - JLG Cream,  J2 - JLG Orange,  C4 - Green



 COMPONENTI IMPAINTO ELETTRICO

 ELECTRICAL SYSTEM COMPONENTS

 COMPOSANTS INSTALLATION ÉLECTRIQUE

 KOMONENTEN ELEKTROANLAGE   
 COMPONENTES INSTALACIÓN ELÉCTRICA 

POS	Codice	 Descrizione	 Description	 Designation	 Benennung	 Descripción
20	1772950019	SCATOLA ESCLUSIONE SICUREZZE COMPLETA TTC	BOX EXCLUSION SAFETY TTC	BOÎTE	GEHÄUSE	CAJA
21	1585570006	SELETTORE	SELECTOR	SÉLECTEUR	WÄHLSCHALTER	SELECTOR
22	1651290015	CHIAVE	KEY	CLÉ	SCHLÜSSEL	LLAVE
23	077706Y1	PIASTRA DI SEPARAZIONE	PLATE SEPARATION	PLAQUE DE SÉPARATION	PLATTENTRENNUNG	PLACA DE SEPARACIÓN
26	1773980004	PULSANTE	BUTTON	BOUTON	DRUCKKNOPF	BOTÓN
27	1628400005	PULSANTE	BUTTON	BOUTON	DRUCKKNOPF	BOTÓN
28	1730720005	SPIA VERDE PARTE AEREA GRANDE	BIG GREEN LIGHT AERIAL PART	VOYANT	KONTROLLLEUCHTE	INDICADOR
29	1556350068	SELETTORE A LEVA 3 POSIZIONI	3 POSITION LEVER SWITCH	SÉLECTEUR	WÄHLSCHALTER	SELECTOR
30	1692150001	BLOCCETTO	BLOCK	BLOC	BLOCK	BLOQUE
31	175726002402	SCATOLA STOP A TERRA MK2 E LL2614 VUOTA	STOP BOX MK2 AND LL2614 EMPTY	BOÎTE STOP	KASTEN STOP	CAJA STOP
31	1770750001	SCATOLA STOP A TERRA LITHIUM LL26/X26/X770 LL15/X15/X430 TT COMPLETA DI CABLAGGIO E CONNETTORE	BOX WITH WIRING	BOÎTE AVEC CÂBLAGE	KASTEN MIT VERKABELUNG	CAJA CON CABLEADO
31	1773980003	SCATOLA STOP A TERRA DIESEL LL2614-X26JP-X770AJ TT COMPLETA DI CABLAGGIO E CONNETTORE	BOX WITH WIRING	BOÎTE AVEC CÂBLAGE	KASTEN MIT VERKABELUNG	CAJA CON CABLEADO
32	04774900	STACCA BATTERIA	BATTERY CUT-OFF DEVICE	COUPE BATTERIE	BATTERIETRENNSCH ALTER	CORTA-BATERÍA



 Main color codes:  J1 - JLG Cream,  J2 - JLG Orange,  C4 - Green











 COMPONENTI IMPAINTO ELETTRICO



 ELECTRICAL SYSTEM COMPONENTS

 COMPOSANTS INSTALLATION ÉLECTRIQUE



 KOMponenten Elektroanlage   
 Componentes Instalación Eléctrica 



POS	Codice	 Descrizione	 Description	 Designation	 Benennung	 Descripción
33	1757250023	SPIA STABILIZZATORE LED COMPLETA DI CONNETTORE	LED LIGHT	TEMOIN LED	KONTROLLLAMPE	INDICADOR LED
34	1739150023	MORSETTO POSITIVO A C PER BATTERIA M10	POSITIVE BATTERY CLAMP "C" M10	BORNE POSITIVE A C POUR BATTERIE M10	POSITIVE KLEMME FÜR BATTERIE M10	BORNE POSITIVO A C PARA BATERÍA M10
35	1739150025	MORSETTO NEGATIVO A C PER BATTERIA M10	NEGATIVE BATTERY TERMINAL C M10	BORNE NEGATIVE A C POUR BATTERIE M10	NEGATIVE KLEMME FÜR BATTERIE M10	BORNE NEGATIVO A C PARA BATERÍA M10
36	1739150024	COPRIMORSETTO NERO PER MORSETTO MARINO	TERMINAL COVER BLACK FOR MARINE TERMINAL	COUVRE-BORNE NOIR POUR BORNE MARINE	SCHWARZE KLEMMENABDECKU NG	CUBRE-BORNE NEGRO PARA BORNE MARINO
37	1739150022	COPRIMORSETTO ROSSO PER MORSETTO MARINO	TERMINAL COVER RED FOR MARINE TERMINAL	CACHE-BORNE ROUGE POUR BORNE MARINE	ROTE KLEMMENABDECKU NG	CUBRE-BORNE ROJO PARA BORNE MARINO
38	1772950021	CENTRALINA 4 RELE' INDIPENDENTI 12V A TENUTA	CONTROL UNIT 4 RELAY 'INDEPENDENT 12V SEALED	UNITÉ DE CONTRÔLE	STEUERGERÄT	UNIDAD DE CONTROL
39	08295000	CONNETTORE PONTE ODU CON RESISTENZA	BRIDGE ODU CONNECTOR WITH RESISTANCE	CONNECTEUR	STECKVERBINDER	CONECTOR
39	18294900	CAVO TELECOMANDO A TERRA VERSIONE ODU COMPLETO DI PONTE	GROUND REMOTE CONTROL CABLE ODU VERSION WITH BRIDGE	CÂBLE TÉLÉCOMMANDE	KABEL FERNBEDIENUNG	CABLE TELEMANDO

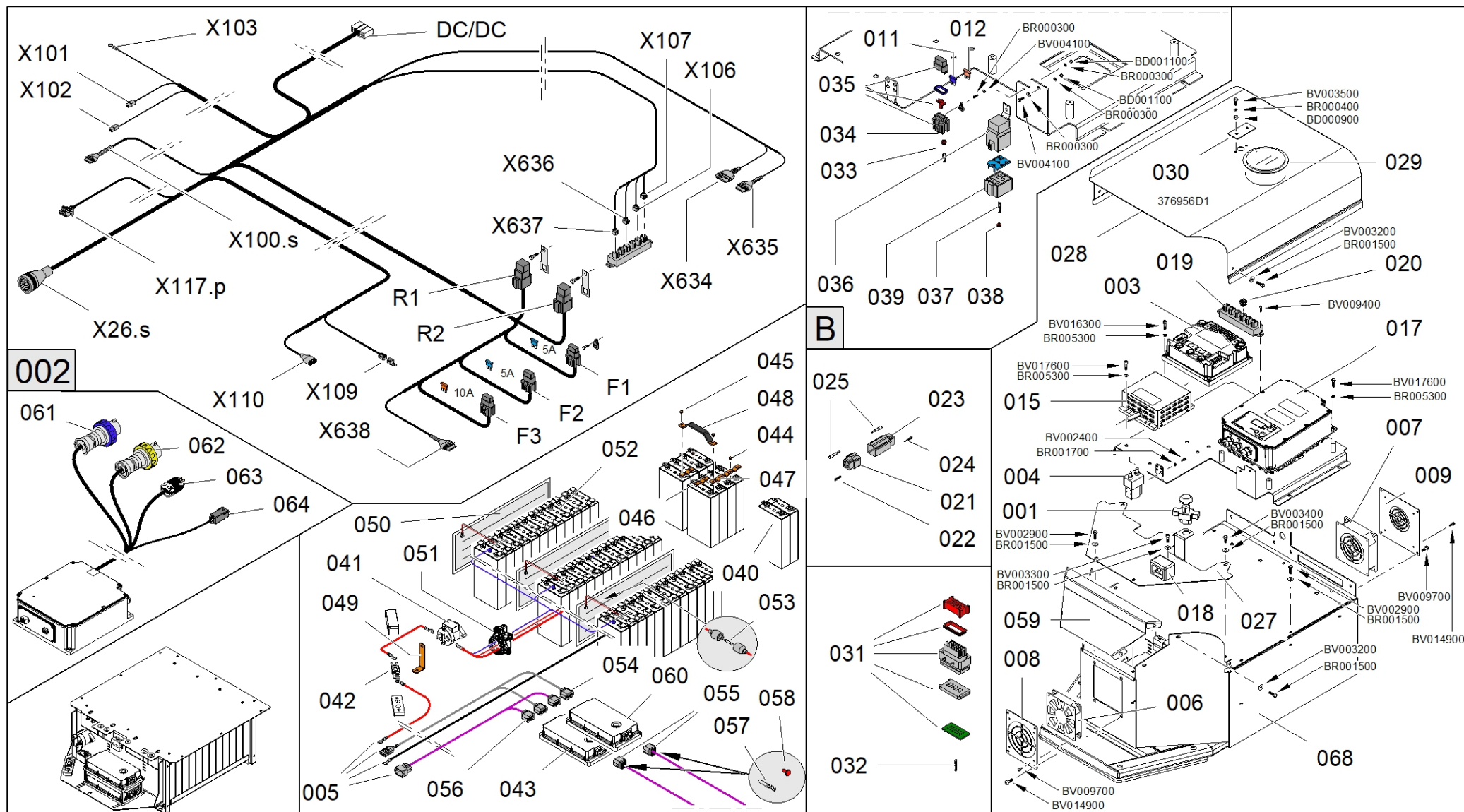

-  COMPONENTI IMPIANTO ELETTRICO LITIO
-  ELECTRICAL SYSTEM COMPONENTS LITHIUM
-  COMPOSANTS INSTALLATION ÉLECTRIQUE LITHIUM



- KOMPONENTEN ELEKTROANLAGE LITHIUM 
- COMPONENTES INSTALACIÓN ELÉCTRICA LITHIUM 









Main color codes:  J1 - JLG Cream,  J2 - JLG Orange,  C4 - Green



 COMPONENTI IMPIANTO ELETTRICO LITIO  
 ELECTRICAL SYSTEM COMPONENTS LITHIUM  
 COMPOSANTS INSTALLATION ÉLECTRIQUE LITHIUM





KOMPONENTEN ELEKTROANLAGE LITHIUM   
 COMPONENTES INSTALACIÓN ELÉCTRICA LITHIUM 



POS	Codice	 Descrizione	 Description	 Designation	 Benennung	 Descripción
1	07827000	STACCABATTERIA A FUNGO 150A NOMINALI	BATTERY DISCONNECTERS 150A NOMINAL	COUPE-BATTERIE	BATTERIE-TRENNSCHALTER	DESCONECTADOR DE BATERÍA
1	081132D1	LAMIERA FISSAGGIO COVER	COVER FIXING SHEET	TÔLE FIXATION COUVERTURE	BEFESTIGUNGSBLECH ABDECKUNG POLYCARBONAT	CHAPA FIJACIÓN COBERTURA
2	17707500	IMPIANTO ELETTRICO LITHIUM LL2614-X26JP-X770AJ T-M	ELECTRICAL SYSTEM LITHIUM LL2614-X26JP X770AJ-T-M	INSTALLATION ÉLECTRIQUE LITHIUM LL2614-X26JP X770AJ-T-M	ELEKTRISCHE ANLAGE LITHIUM LL2614-X26JP X770AJ-T-M	INSTALACIÓN ELÉCTRICA LITHIUM LL2614-X26JP X770AJ-T-M
2	18114400	KIT ELE INTEGRAZIONE LITIO+DIESEL BIENERGY 72V-100AH COMPLETO DI LINEA 220-110V	INTEGRATION ELECTRICAL KIT LITHIUM BIENERGY DIESEL + 72V-100AH COMPLETE LINE 220-110V	KIT COMPOSANTS ÉLECTRIQUES	SATZ ELEKTRISCHER BAUTEILE	JUEGO COMPONENTES ELÉCTRICOS
3	1694760003	INVERTER	INVERTER	INVERTER	INVERTER	INVERTER
3	2694760001	FUSIBILE	FUSE	FUSIBLE	SICHERUNG	FUSIBLE
3	28120400	INVERTER ACE2 DOPPIO MICRO PACCO LITIO 76V PER MOTORE 3,5KW BIENERGY	INVERTER ACE2 DOUBLE MICRO PACKAGE LITHIUM 76V FOR MOTOR 3,5KW BIENERGY	INVERTER	INVERTER	INVERTER
4	26429300	TELERUTTORE	POWER SWITCH RELAY	TÉLÉRUPTEUR	FERNSCHALTER	TELERUPTOR
5	17795200	PACCO BATTERIE 76V 100AH MID CON IMPIANTO ELETTRICO	BATTERY 76V 100AH MID WITH ELECTRICAL SYSTEM	PACK BATTERIES 76V 100AH MID AVEC INSTALLATION ÉLECTRIQUE	BATTERIEPAKET 76V 100AH MID MIT ELEKTRISCHER ANLAGE	PAQUETE BATERIAS 76V 100AH MID CON INSTALACIÓN ELÉCTRICA
5	18374900	PACCO BATTERIE 76V 120AH MID CON IMPIANTO ELETTRICO	BATTERY 76V 120AH MID WITH ELECTRICAL SYSTEM	PACK BATTERIES 76V 120AH MID AVEC INSTALLATION ÉLECTRIQUE	BATTERIEPAKET 76V 120AH MID MIT ELEKTRISCHER ANLAGE	PAQUETE BATERIAS 76V 120AH MID CON INSTALACIÓN ELÉCTRICA



Main color codes:  J1 - JLG Cream,  J2 - JLG Orange,  C4 - Green

 COMPONENTI IMPIANTO ELETTRICO LITIO  
 ELECTRICAL SYSTEM COMPONENTS LITHIUM  
 COMPOSANTS INSTALLATION ÉLECTRIQUE LITHIUM





KOMPONENTEN ELEKTROANLAGE LITHIUM   
 COMPONENTES INSTALACIÓN ELÉCTRICA LITHIUM 



POS	Codice	 Descrizione	 Description	 Designation	 Benennung	 Descripción
6	1690690001	VENTOLA ANTERIORE	FRONT FAN	VENTILATEUR	LÜFTERRAD	VENTILADOR
7	1690690002	VENTOLA POSTERIORE	REAR FAN	VENTILATEUR	LÜFTERRAD	VENTILADOR
8	067808H2	TAPPO VENTOLA POSTERIORE	CAP REAR FAN	BOUCHON	VERSCHLUSS	TAPÓN
9	075692H2	PIASTRA FISSAGGIO VENTOLA	PLATE	PLAQUE	PLATTE	PLACA
11	05760900	FUSIBILE 10A	FUSE 10A	FUSIBLE 10A	SICHERUNG 10A	FUSIBLE 10A
12	05760700	FUSIBILE A LAMA 5A	FUSE 5A	FUSIBLE 5A	SICHERUNG 5A	FUSIBLE 5A
15	26947900	TRASFORMATORE	TRANSFORMER	TRANSFORMATEUR	TRANSFORMATOR	TRANSFORMADOR
17	17604200	CARICABATTERIE 80V-240V LITHIUM	LITHIUM BATTERY CHARGER 80V-240V	LITHIUM BATTERIE 80V-240V	BATTERIELADEGERÄT 80V-240V LITHIUM	CARGADOR DE BATERÍA 80V-240V LITIO
18	1730720088	ISOLATORE CONNESSIONE MASSA	INSULATOR EARTH CONNECTION	ISOLATEUR	ISOLATOR	AISLADOR
19	1730720087	CONNETTORE DERIVAZIONE CAN	JUNCTION CONNECTOR CAN	CONNECTEUR	VERBINDER	CONECTOR
20	1730720086	TAPPO CONNETTORE 2 VIE	CONNECTOR PLUG 2 WAY	BOUCHON CONNECTEUR	VERSCHLUSS VERBINDER	TAPA CONECTOR
21	1757250009	CONNETTORE PORTA FEMMINE 4 VIE MOLEX 220-110V 20-25A	CONNECTOR	CONNECTEUR	VERBINDER	CONECTOR
22	1757250011	PUNTALINO	FERRULE	EMBOUT	ZWINGE	PUNTERA
23	1757250010	CONNETTORE PORTA MASCHI 4 VIE MOLEX 220-110V 20-25A	CONNECTOR	CONNECTEUR	VERBINDER	CONECTOR
24	1757250013	PUNTALINO MASCHIO PER CONNETTORE 4 VIE MOLEX 220-110V 20-25A	FERRULE	EMBOUT	ZWINGE	PUNTERA



Main color codes:  J1 - JLG Cream,  J2 - JLG Orange,  C4 - Green



 COMPONENTI IMPIANTO ELETTRICO LITIO  
 ELECTRICAL SYSTEM COMPONENTS LITHIUM  
 COMPOSANTS INSTALLATION ÉLECTRIQUE LITHIUM





KOMPONENTEN ELEKTROANLAGE LITHIUM   
 COMPONENTES INSTALACIÓN ELÉCTRICA LITHIUM 



POS	Codice	 Descrizione	 Description	 Designation	 Benennung	 Descripción
25	1757250012	TAPPO PER CHIUSURA FORI SU CONNETTORE 4 VIE MOLEX 220-110V 20-25A	CAP	BOUCHON	DECKEL	TAPA
26	176952D1	SUPPORTO COMPONENTI CASSONE LITIO LL2614 MID COMPLETO DI SPUGNE E INSERTI	LITIO COMPONENTS SUPPORT LL2614 MID COMPLETE WITH SPONGES	SUPPORT COMPOSANTS ÉLECTRIQUES	HALTERUNG E-TEILE	SOPORTE COMPONENTES ELÉCTRICOS
26	181127D1	SUPPORTO COMPONENTI CASSONE LITIO LL2614 BI-ENERGY COMPLETO DI SPUGNE E INSERTI	LITIO COMPONENTS SUPPORT BI-ENERGY LL2614 MID COMPLETE WITH SPONGES	SUPPORT	HALTERUNG	SOPORTE
27	176949D1	CHIUSURA SUPERIORE VANO CELLE COMPLETA DI SPUGNE E INSERTI	CLOSING UPPER COMPARTMENT CELL FULL OF SPONGE AND INSERTS	PLAQUE DE VERROUILLAGE	ARRETIERPLATTE	PLACA DE BLOQUEO
27	181110D1	CHIUSURA SUPERIORE VANO CELLE BI-ENERGY COMPLETA DI SPUGNE E INSERTI	CLOSING UPPER COMPARTMENT BI-ENERGY CELL FULL OF SPONGE AND INSERTS	FERMETURE SUPÉRIEURE	OBERE SCHLIEßUNG	CIERRE SUPERIOR
28	176956D1	COPERCHIO CASSONE LITIO LL2614 COMPLETO DI SPUGNE E VETRO	LITHIUM COVER LL2614 WITH SPONGES AND GLASS	COUVERTURE BATTERIES LITHIUM	ABDECKUNG LITHIUM-BATTERIEN	CUBIERTA BATERIAS LITHIUM
28	181125D1	COPERCHIO CASSONE LITIO BI-ENERGY LL2614 COMPLETO DI SPUGNE	BI-ENERGY LITHIUM COVER LL2614 WITH SPONGES	COUVERCLE	DECKEL	TAPA

Main color codes:  J1 - JLG Cream,  J2 - JLG Orange,  C4 - Green



 COMPONENTI IMPIANTO ELETTRICO LITIO  
 ELECTRICAL SYSTEM COMPONENTS LITHIUM  
 COMPOSANTS INSTALLATION ÉLECTRIQUE LITHIUM



KOMPONENTEN ELEKTROANLAGE LITHIUM   
 COMPONENTES INSTALACIÓN ELÉCTRICA LITHIUM 



POS	Codice	 Descrizione	 Description	 Designation	 Benennung	 Descripción
28	181266D1	FIANCO DX COMPLETO COPERCHIO LITIO	COMPLETE RIGHT PLATE LITHIUM COVER	CÔTÉ DROIT	RECHTE SEITE DES DECKELS	LADO DERECHO TAPA
28	181267D1	FIANCO SX COMPLETO COPERCHIO LITIO	COMPLETE LEFT PLATE LITHIUM COVER	CÔTÉ GAUCHE	LINKE SEITE DES DECKELS	LADO IZQUIERDO TAPA
29	08113100	COVER TRASPARENTE CARICABATTERIE	TRANSPARENT CHARGER COVER	COUVERTURE EN POLYCARBONATE	ABDECKUNG AUS POLYCARBONAT	COBERTURA EN POLICARBONATO
30	078574D1	CHIUSURA FORI FISSAGGIO PER LAMPEGGIANTE SU PACCO LITIO	CLOSING FIXING HOLES FOR FLASHING ON PACK LITHIUM	FERMETURE	SCHLUSS	CIERRE
32	16774800	PUNTALINO FE05-1 MMQ AMPSEAL STAGNATO GL14.70 BATTERY	TERMINAL	BORNE	KLEMME	BORNE
33	1757260006	PUNTALINO PER PORTAFUSIBILE	FERRULE FOR FUSE HOLDER	BORNE	KLEMME	BORNE
34	1757260007	GOMMINO PER PORTAFUSIBILE	RUBBER FERRULE FOR FUSE HOLDER	INSERT CAOUTCHOUC	GUMMISATZ	INSERCIÓN DE GOMA
35	1757260001	PORTAFUSIBILE	FUSE HOLDER	PORTE-FUSIBLE	SICHERUNGSHALTER	PORTAFUSIBILE
36	1776330003	RELE' MINI TYCO 12V PER CONNETTORE A TENUTA (MK2 DA C170000893)	RELAY 'MINI 12V TYCO CONNECTOR SEAL (MK2 FROM C170000893)	RELAIS	RELAIS	RELÉ
37	1776330007	PUNTALINI PER RELE' A TENUTA MINI TYCO 12V (MK2 DA C170000893)	FERRULE FOR RELAY SEAL MINI 12V TYCO (MK2 FROM C170000893)	BORNE	KLEMME	BORNE
38	1776330005	GOMMINO PER RELE' A TENUTA MINI TYCO 12V (MK2 DA C170000893)	RUBBER FOR RELAY SEAL MINI 12V TYCO (MK2 FROM C170000893)	JOINT RELÉ	GUMMIDICHTUNG	JUNTA DE GOMA



Main color codes:  J1 - JLG Cream,  J2 - JLG Orange,  C4 - Green







 COMPONENTI IMPIANTO ELETTRICO LITIO  
 ELECTRICAL SYSTEM COMPONENTS LITHIUM  
 COMPOSANTS INSTALLATION ÉLECTRIQUE LITHIUM





KOMPONENTEN ELEKTROANLAGE LITHIUM   
 COMPONENTES INSTALACIÓN ELÉCTRICA LITHIUM 



POS	Codice	 Descrizione	 Description	 Designation	 Benennung	 Descripción
39	1776330004	PORTA RELE' A TENUTA PER MINI TYCO 12V (MK2 DA C170000893)	HOLDER RELAY SEAL FOR MINI 12V TYCO (MK2 FROM C170000893)	PORTE RELAIS	RELAISHALTER	PORTARELÉ
40	1779520002	MODULO CELLE LITIO MIDAC 19,2V 100AH CONFIG. "A" COMPLETO DI CONNESSIONE A CORREDO	MIDAC LITHIUM CELL MODULE 19,2V 100AH CONFIG. "A" COMPLETE WITH CONNECTION SUPPLIED	MODULE BATTERIE LITHIUM-ION	MODUL LITHIUM-IONEN-BATTERIE	MÓDULO BATERÍA LITIO
40	1837490003	MODULO CELLE LITIO MIDAC 19,2V 120AH CONFIG. "A" COMPLETO DI CONNESSIONE A CORREDO	MIDAC LITHIUM CELL MODULE 19,2V 120AH CONFIG. "A" COMPLETE WITH CONNECTION SUPPLIED	MODULE BATTERIE LITHIUM-ION	MODUL LITHIUM-IONEN-BATTERIE	MÓDULO BATERLA LITIO
41	2781020012	TELERUTTORE DI POTENZA 500A	RELAY OF INTERNAL POWER PACK 500A	TELERUPTEUR 500A	FERNSCHALTER 500A	TELEINTERRUPTOR 500A
42	2781020014	FUSIBILE 400A	FUSE 400A	FUSIBLE	SICHERUNG	FUSIBLE
43	1779520001	BMS MASTER MID PROGRAMMATO PER 76V 100AH	BMS MASTER MID FOR 76V 100AH	BMS MASTER MID 76V 100AH	BMS MASTER MID 76V 100AH	BMS MASTER MID 76V 100AH
43	1803220004	MRS RELÈ 12V S3 IMPULSO 2 SEC	MRS RELAY 12V S3 PULSE 2 SEC	MRS RELÉ 12V S3 IMPULSION 2 SEC	MRS RELAIS 12V S3 IMPULS 2 SEK	MRS RELÉ 12V S3 IMPULSO 2 SEC
43	1837490001	BMS MASTER MID PROGRAMMATO PER 76V 120AH	BMS MASTER MID FOR 76V 120AH	BMS MASTER MID 76V 120AH	BMS MASTER MID 76V 120AH	BMS MASTER MID 76V 120AH
44	2781020003	RIVETTO RAME H=10	COPPER RIVET H=10	RIVET	NIETE	REMACHE
45	2781020004	RIVETTO RAME H=12	COPPER RIVET H=12	RIVET	NIETE	REMACHE
46	2781020005	LAMA FISSAGGIO CELLE 2 FORI	PLATE FIXING CELLS 2 HOLES	PLAQUE DE FIXATION	MONTAGEPLATTE	PLACA DE FIJACION
47	2781020006	LAMA FISSAGGIO CELLE 4 FORI	PLATE FIXING CELLS 4 HOLES	PLAQUE DE FIXATION	MONTAGEPLATTE	PLACA DE FIJACION



Main color codes:  J1 - JLG Cream,  J2 - JLG Orange,  C4 - Green



 COMPONENTI IMPIANTO ELETTRICO LITIO  
 ELECTRICAL SYSTEM COMPONENTS LITHIUM  
 COMPOSANTS INSTALLATION ÉLECTRIQUE LITHIUM





KOMPONENTEN ELEKTROANLAGE LITHIUM   
 COMPONENTES INSTALACIÓN ELÉCTRICA LITHIUM 

POS	Codice	 Descrizione	 Description	 Designation	 Benennung	 Descripción
48	2781020007	LAMA DI COLLEGAMENTO TRA MODULI	PLATE CONNECTION BETWEEN MODULES	PLAQUE DE CONEXION	VERBINDUNGSPLATTE	PLACA DE CONEXIÓN
49	2781020008	LAMA COLLEGAMENTO TELERUTTORE	PLATE CONNECTION RELAY	PLACA DE CONEXIÓN	VERBINDUNGSPLATTE	PLACA DE CONEXIÓN
50	2781020010	HEATER 76V 100W	HEATER 76V 100W	CHAUFFE 76V 100W	HEIZUNG 76V 100W	CALENTADOR 76V 100W
51	2781020011	SENSORE LEM PER LITIO MID	LEM SENSOR FOR LITHIUM MID	CAPTEUR	SENSOR	SENSOR
52	2781020013	SENSORE TEMPERATURA PACCO LITIO MID	TEMPERATURE SENSOR PACK LITHIUM MID	CAPTEUR	SENSOR	SENSOR
53	2781020015	FUSIBILE	FUSE	FUSIBLE	SICHERUNG	FUSIBLE
54	2781020021	CONNETTORE BMS 26 VIE	CONNECTOR BMS 26 WAYS	CONNECTEUR	VERBINDER	CONECTOR
55	2781020020	CONNETTORE BMS 34 VIE FASATURA 2	CONNECTOR BMS 34 WAYS STEP 2	CONNECTEUR	VERBINDER	CONECTOR
56	2781020019	CONNETTORE BMS 34 VIE FASATURA 1	CONNECTOR BMS 34 WAYS STEP 1	CONNECTEUR	VERBINDER	CONECTOR
57	2781020022	PIN PER CONNETTORI BMS 0,75-1,25	PIN CONNECTORS FOR BMS 0.75-1.25	BROCHE POUR CONNECTEURS	PIN-ANSCHLÜSSE	PIN PARA CONECTORES
58	2781020023	TAPPO PER CONNETTORI BMS	CAP FOR CONNECTORS BMS	COUVERCLE	DECKEL	TAPA
59	176957D1	CHIUSURA SUPERIORE CASSONE LITIO LL2614 COMPLETA DI INSERTI	UPPER CLOSURE LL2614 LITHIUM COMPLETE WITH INSERTS	PLAQUE DE VERROUILLAGE SUPÉRIEURE	OBERE ARRETIERPLATTE	PLACA DE BLOQUEO SUPERIOR
59	181124D1	CHIUSURA SUPERIORE CASSONE LITIO BI-ENERGY COMPLETA DI INSERTI	UPPER CLOSURE BI-ENERGY LITHIUM COMPLETE WITH INSERTS	FERMETURE SUPÉRIEURE	OBERE SCHLIEßUNG	CIERRE SUPERIOR

Main color codes:  J1 - JLG Cream,  J2 - JLG Orange,  C4 - Green

 COMPONENTI IMPIANTO ELETTRICO LITIO  
 ELECTRICAL SYSTEM COMPONENTS LITHIUM  
 COMPOSANTS INSTALLATION ÉLECTRIQUE LITHIUM

KOMPONENTEN ELEKTROANLAGE LITHIUM   
 COMPONENTES INSTALACIÓN ELÉCTRICA LITHIUM 

POS	Codice	 Descrizione	 Description	 Designation	 Benennung	 Descripción
60	1837490002	BMS SLAVE MID PROGRAMMATO PER 76V 120AH	BMS SLAVE MID 76V 120AH	BMS SLAVE MID 76V 120AH	BMS SLAVE MID 76V 120AH	BMS SLAVE MID 76V 120AH
60	2781020018	BMS SLAVE MID PROGRAMMATO PER 76V 100AH	BMS SLAVE MID 76V 100AH	BMS SLAVE MID 76V 100AH	BMS SLAVE MID 76V 100AH	BMS SLAVE MID 76V 100AH
65	1779520003	MODULO CELLE LITIO MIDAC 19,2V 100AH CONFIG. "B" COMPLETO DI CONNESSIONE A CORREDO	MIDAC LITHIUM CELL MODULE 19,2V 100AH CONFIG. "B" COMPLETE WITH CONNECTION SUPPLIED	MODULE BATTERIE LITHIUM-ION	MODUL LITHIUM-IONEN-BATTERIE	MÓDULO BATERÍA LITIO
65	1837490004	MODULO CELLE LITIO MIDAC 19,2V 120AH CONFIG. "B" COMPLETO DI CONNESSIONE A CORREDO	MIDAC LITHIUM CELL MODULE 19,2V 120AH CONFIG. "B" COMPLETE WITH CONNECTION SUPPLIED	MODULE BATTERIE LITHIUM-ION	MODUL LITHIUM-IONEN-BATTERIE	MÓDULO BATERLA LITIO
66	1779520004	CABLAGGIO PER CELLE LITIO 76V 100AH (SPG0406)	WIRING FOR LITHIUM CELLS 76V 100AH (SPG0406)	CÂBLAGE	VERKABELUNG	CABLEADO
67	1779520005	CABLAGGIO PER CONNESSIONI BMS LITIO 76V 100AH (SPG0406)	WIRING FOR BMS LITHIUM CONNECTIONS 76V 100AH (SPG0406)	CÂBLAGE	VERKABELUNG	CABLEADO
68	176958D1	CASSONE PER PACCO LITIO LL2614 COMPLETO DI SPUGNE	BOX LITHIUM PACK LL2614 WITH COMPLETE WITH SPONGES AND INSERTS			





 COMPONENTI IMPIANTO ELETTRICO LITIO

 ELECTRICAL SYSTEM COMPONENTS LITHIUM



 COMPOSANTS INSTALLATION ÉLECTRIQUE LITHIUM

 KOMPONENTEN ELEKTROANLAGE LITHIUM

 COMPONENTES INSTALACIÓN ELÉCTRICA LITHIUM



POS	Codice	 Descrizione	 Description	 Designation	 Benennung	 Descripción
68	181138D1	CASSONE PER PACCO LITIO BI-ENERGY LL2614 COMPLETO DI SPUGNE	BI-ENERGY BOX LITHIUM PACK LL2614 WITH COMPLETE WITH SPONGES AND INSERTS			



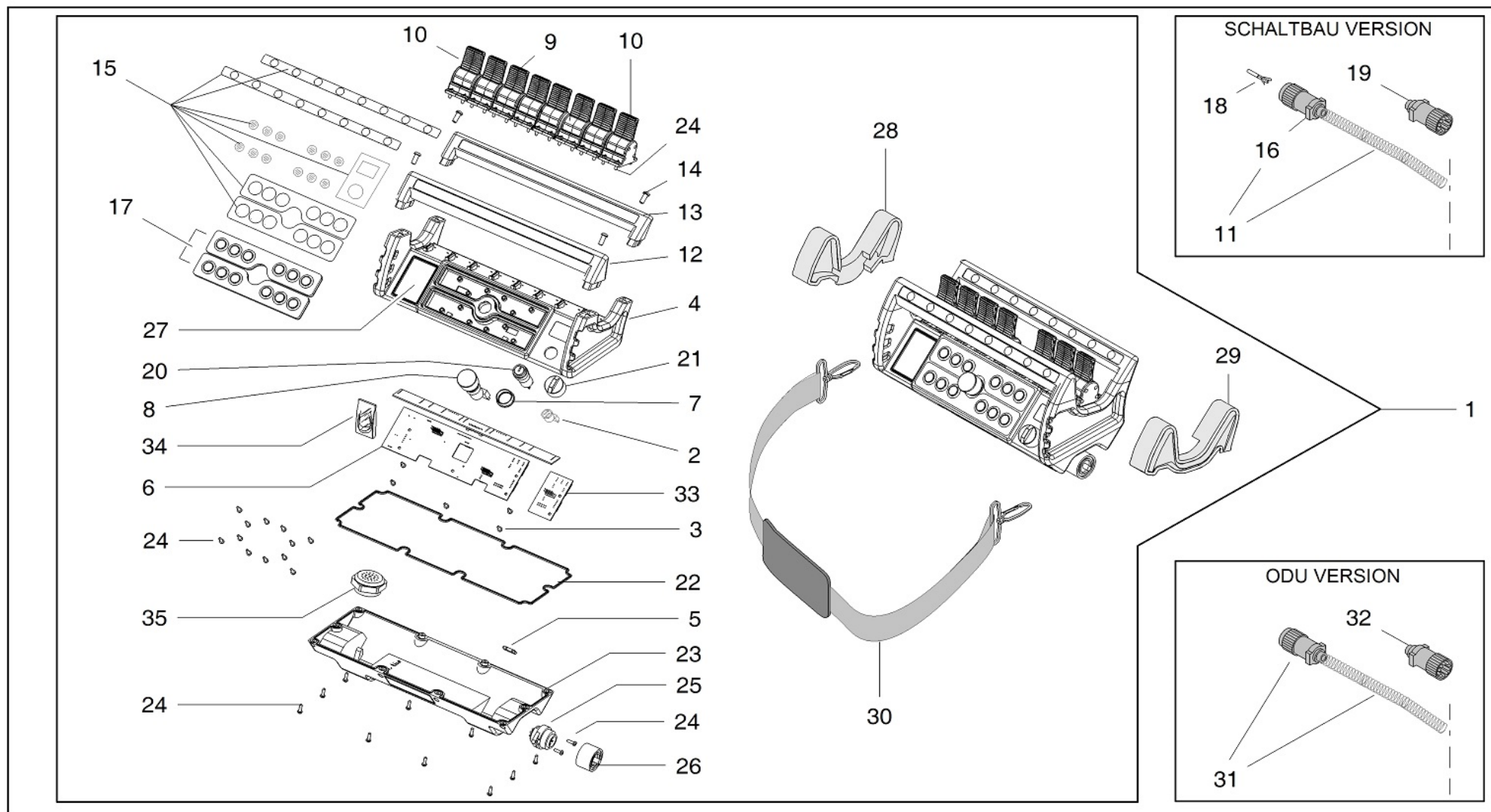

 TELECOMANDO  
 REMOTE CONTROL  
 TÉLÉCOMMANDE

FERNSTEUERUNG   
 TELECOMANDO 











Main color codes:  J1 - JLG Cream,  J2 - JLG Orange,  C4 - Green







 TELECOMANDO  
 REMOTE CONTROL  
 TÉLÉCOMMANDE





FERNSTEUERUNG   
 TELECOMANDO 



POS	Codice	 Descrizione	 Description	 Designation	 Benennung	 Descripción
1	27237400	TELECOMANDO CASE GRIGIO	REMOTE CONTROL GREY CASE	TÉLÉCOMMANDE	FERNSTEUERUNG	TELECOMANDO
1	28095300	TELECOMANDO NUOVO DISPLAY ODU	REMOTE CONTROL NEW DISPLAY ODU	TÉLÉCOMMANDE ODU	FERNSTEUERUNG ODU	TELECOMANDO ODU
2	07359400	CONTATTO PER STOP EMERGENZA TELECOMANDO 3S	CONTACT FOR EMERGENCY STOP REMOTE CONTROL 3S	CONTACTE POUR ARRET D'URGENCE	KONTAKT FÜR NOTSTOP	CONTACTO PARA PARADA DE EMERGENCIA
3	2646170003	VITI SCHEDA ELETTRONICA	ELECTRONIC BOARD SCREWS	VIS	SCHRAUBEN	TORNILLOS
4	2723740001	COPERCHIO SUPERIORE TELECOMANDO CASE GRIGIO + DISPLAY E PULSANTI (PER RICAMBIO È NECESSARIO IL SN DEL TELECOMANDO)	TOP COVER REMOTE CONTROL CASE GREY + DISPLAY AND BUTTONS (AS SPARE IS COMPULSORY THE SN OF REMOTE CONTROL)	COUVERCLE	DECKEL	TAPA
4	2723740002	COPERCHIO SUPERIORE TELECOMANDO CASE GRIGIO SOLO COPERCHIO, SENZA COMPONENTI E SENZA DISPLAY	TOP COVER REMOTE CONTROL CASE GREY ONLY CASE, WITHOUT COMPONENTS AND DISPLAY	COUVERCLE	DECKEL	TAPA
4	2801270001	COPERCHIO SUPERIORE TELECOMANDO DISPLAY A COLORI CASE GRIGIO SOLO COPERCHIO SENZA COMPONENTI E SENZA DISPLAY	TOP COVER REMOTE CONTROL COLOR DISPLAY CASE GREY ONLY CASE, WITHOUT COMPONENTS AND DISPLAY	COUVERCLE	DECKEL	TAPA



Main color codes:  J1 - JLG Cream,  J2 - JLG Orange,  C4 - Green

 TELECOMANDO  
 REMOTE CONTROL  
 TÉLÉCOMMANDE





FERNSTEUERUNG   
 TELECOMANDO 



POS	Codice	 Descrizione	 Description	 Designation	 Benennung	 Descripción
5	07359500	CONTATTO REED INTERNO TELECOMANDO 3S	REED CONTACT INTERNAL REMOTE 3S	REED CONTACT INTÉRIEUR 3S DISTANCE	REEDKONTAKT INDOOR REMOTE 3S	CONTACTO REED 3S REMOTO DE INTERIOR
6	2646170002	SCHEDA ELETTRONICA PER TELECOMANDO	ELECTRONIC BOARD FOR REMOTE CONTROL	FICHE ÉLECTRIQUE	ELEKTRONISCHE PLATINE	PLACA ELECTRÓNICA
6	2801270003	SCHEDA ELETTRONICA PER TELECOMANDO DISPLAY A COLORI	ELECTRONIC BOARD FOR REMOTE CONTROL COLOR DISPLAY	FICHE ÉLECTRIQUE	ELEKTRONISCHE PLATINE	PLACA ELECTRÓNICA
7	2646170007	ANELLO	RING	BAGUE	RING	ANILLO
8	2646170008	PULSANTE EMERGENZA	EMERGENCY BUTTON	BOUTON D'URGENCE	NOTSTOP KNOPF	PULSADOR DE EMERGENCIA
9	17550700	KIT PROTEZIONE IN GOMMA PER JOYSTICK NERA	PROTECTION KIT	PROTECTION KIT	GUMMISCHUTZ KIT	PROTECCIÓN DE GOMA
9	2646170009	LEVA NERA	LEVER BLACK	LEVIER	HEBEL	PALANCA
9	2646170011	COPERCHIO	COVER	COUVERCLE	DECKEL	TAPA
10	17550800	KIT PROTEZIONE IN GOMMA PER JOYSTICK ROSSA	PROTECTION	PROTECTION	GUMMISCHUTZ	PROTECCION DE GOMA
10	2646170010	LEVA ROSSA	LEVER RED	LEVIER	HEBEL	PALANCA
11	17235800	CAVO TELECOMANDO COMPLETO IIS /200	COMPLETE REMOTE CONTROL CABLE IIS / 200	CÂBLE COMPLET TÉLÉCOMMANDE IIS /200	FERNBEDIENUNGSKA BEL KOMPLETT IIS / 200	CABLE TELECOMANDO COMPLETO IIS /200
12	2646170012	IMPUGNATURA SUPERIORE	GRIP UPPER PART	POIGNÉE	GRIFF	EMPUÑADURA
13	2646170013	IMPUGNATURA INFERIORE	GRIP LOWER PART	POIGNÉE	GRIFF	EMPUÑADURA
14	2646170014	VITE	SCREW	VIS	SCHRAUBE	TORNILLO
15	27005200	KIT ADESIVI	DECALS KIT	KIT AUTOCOLLANTS	AUFKLEBERSATZ	KIT PEGATINAS
16	2646170032	CONNETTORE COLLEGAMENTO TELECOMANDO	CONNECTOR FOR REMOTE CONTROL	CONNECTEUR	VERBINGER	CONECTOR



Main color codes:  J1 - JLG Cream,  J2 - JLG Orange,  C4 - Green



 TELECOMANDO  
 REMOTE CONTROL  
 TÉLÉCOMMANDE





FERNSTEUERUNG   
 TELECOMANDO 



POS	Codice	 Descrizione	 Description	 Designation	 Benennung	 Descripción
17	2646170017	PULSANTI	BUTTONS	BOUTONS	DRUCKKNÖPFE	BOTONES
18	27283000	PUNTALINO FEMMINA PER CONNETTORE TELECOMANDO	TERMINAL FEMALE CONNECTOR FOR REMOTE CONTROL	CONNECTEUR FEMELLE	VERBINDUNG	CONECTOR
18	2728300001	PUNTALINO MASCHIO PER CONNETTORE TELECOMANDO	TERMINAL MALE CONNECTOR FOR REMOTE CONTROL	CONNECTEUR	VERBINDER	CONECTOR
19	1684540001	DISPOSITIVO DI COMANDO PER ABILITAZIONE EMERGENZA A TERRA	CONTROL DEVICE FOR ACTIVATING THE EMERGENCY GROUND	DISPOSITIF DE COMMANDE EN CAS D'URGENCE	STEUERVORRICHTUNG IM NOTFALL	DISPOSITIVO DE CONTROL DE EMERGENCIA
20	2683930001	INTERRUTTORE	SWITCH	INTERRUPTEUR	SCHALTER	INTERRUPTOR
21	2683930002	CHIAVE ACCENSIONE	IGNITION KEY	CLÉ DE DÉMARRAGE	ZÜNDSCHLÜSSEL	LLAVE DE ENCENDIDO
22	2646170022	GUARNIZIONE	GASKET	JOINT	DICHTUNG	GUARNICIÓN
22	2801270008	GUARNIZIONE TELECOMANDO DISPLAY A COLORI	GASKET REMOTE CONTROL COLOR DISPLAY	JOINT	DICHTUNG	GUARNICIÓN
23	2646170023	COPERCHIO INFERIORE	COVER LOWER PART	COUVERCLE	DECKEL	TAPA
23	2827500001	COPERCHIO INFERIORE TELECOMANDO DISPLAY A COLORI+COMPONENTI ODU	COVER LOWER PART REMOTE CONTROL COLOR DISPLAY+COMPONENTS ODU	COUVERCLE	DECKEL	TAPA
24	2646170024	VITE	SCREW	VIS	SCHRAUBE	TORNILLO
25	2646170025	CONNETTORE	CONNECTOR	CONNECTEUR	VERBINGER	CONECTOR
25	2827500002	CONNETTORE	CONNECTOR	CONNECTEUR	VERBINGER	CONECTOR
26	2646170026	COPERCHIO CONNETTORE	COVER CONNECTOR	COUVERCLE	DECKEL	TAPA



Main color codes:  J1 - JLG Cream,  J2 - JLG Orange,  C4 - Green

 TELECOMANDO  
 REMOTE CONTROL  
 TÉLÉCOMMANDE





FERNSTEUERUNG   
 TELECOMANDO 



POS	Codice	 Descrizione	 Description	 Designation	 Benennung	 Descripción
26	2827500003	COPERCHIO CONNETTORE	COVER CONNECTOR	COUVERCLE	DECKEL	TAPA
27	07320200	SCHERMO LCD (PER RICAMBIO È NECESSARIO IL SN DEL TELECOMANDO)	DISPLAY (AS SPARE IS COMPULSORY THE SN OF REMOTE CONTROL)	ÉCRAN	DISPLAY	PANTALLA
27	2801270004	SCHERMO LCD A COLORI (PER RICAMBIO È NECESSARIO IL SN DEL TELECOMANDO)	DISPLAY COLOR (AS SPARE IS COMPULSORY THE SN OF REMOTE CONTROL)	ÉCRAN	DISPLAY	PANTALLA
28	07027100	PROTEZIONE SINISTRA	LEFT PROTECTION	PROTECTION GAUCHE	ABDECKUNG LINKS	PROTECCIÓN IZQUIERDA
29	07027200	PROTEZIONE DESTRA	RIGHT PROTECTION	PROTECTION DROITE	ABDECKUNG RECHTS	PROTECCIÓN DERECHA
30	2646170030	CINGHIA	BELT	COURROIE	RIEMEN	CORREA
31	18249000	CAVO TELECOMANDO COMPLETO VERSIONE ODU	COMPLETE REMOTE CONTROL CABLE ODU VERSION	CÂBLE TÉLÉCOMMANDE	KABEL FERNBEDIENUNG	CABLE TELEMANDO
32	08295000	CONNETTORE PONTE ODU CON RESISTENZA	BRIDGE ODU CONNECTOR WITH RESISTANCE	CONNECTEUR	STECKVERBINDER	CONECTOR
33	2646170006	SCHEDA DI TENSIONE TELECOMANDO(Only for remote control with white/black display)	POWER BOARD FOR REMOTE CONTROL(Only for remote control with white/black display)	CARTE(Only for remote control with white/black display)	PLATINE(Only for remote control with white/black display)	PLACA(Only for remote control with white/black display)
34	2646170036	KIT CABLAGGIO INTERNO TELECOMANDO(Only for remote control with white/black display)	INTERNAL CABLE KIT FOR REMOTE CONTROL(Only for remote control with white/black display)	KIT CÂBLES TELECOMMANDE(Onl y for remote control with white/black display)	SATZ KABEL FERNBEDIENUNG(Onl y for remote control with white/black display)	KIT CABLES TELEMANDO(Only for remote control with white/black display)



Main color codes:  J1 - JLG Cream,  J2 - JLG Orange,  C4 - Green

 TELECOMANDO  
 REMOTE CONTROL  
 TÉLÉCOMMANDE



FERNSTEUERUNG   
 TELECOMANDO 

POS	Codice	 Descrizione	 Description	 Designation	 Benennung	 Descripción
35	2646170027	CICALINO COMPLETO DI SCHEDA ELETTRONICA TELECOMANDO(Only for remote control with white/black display)	BEEPER FOR REMOTE CONTROL(Only for remote control with white/black display)	BUZZER(Only for remote control with white/black display)	SUMMER(Only for remote control with white/black display)	ZUMBADOR COMPLETO DE TARJETA ELECTRÓNICA TELECOMANDO(Only for remote control with white/black display)

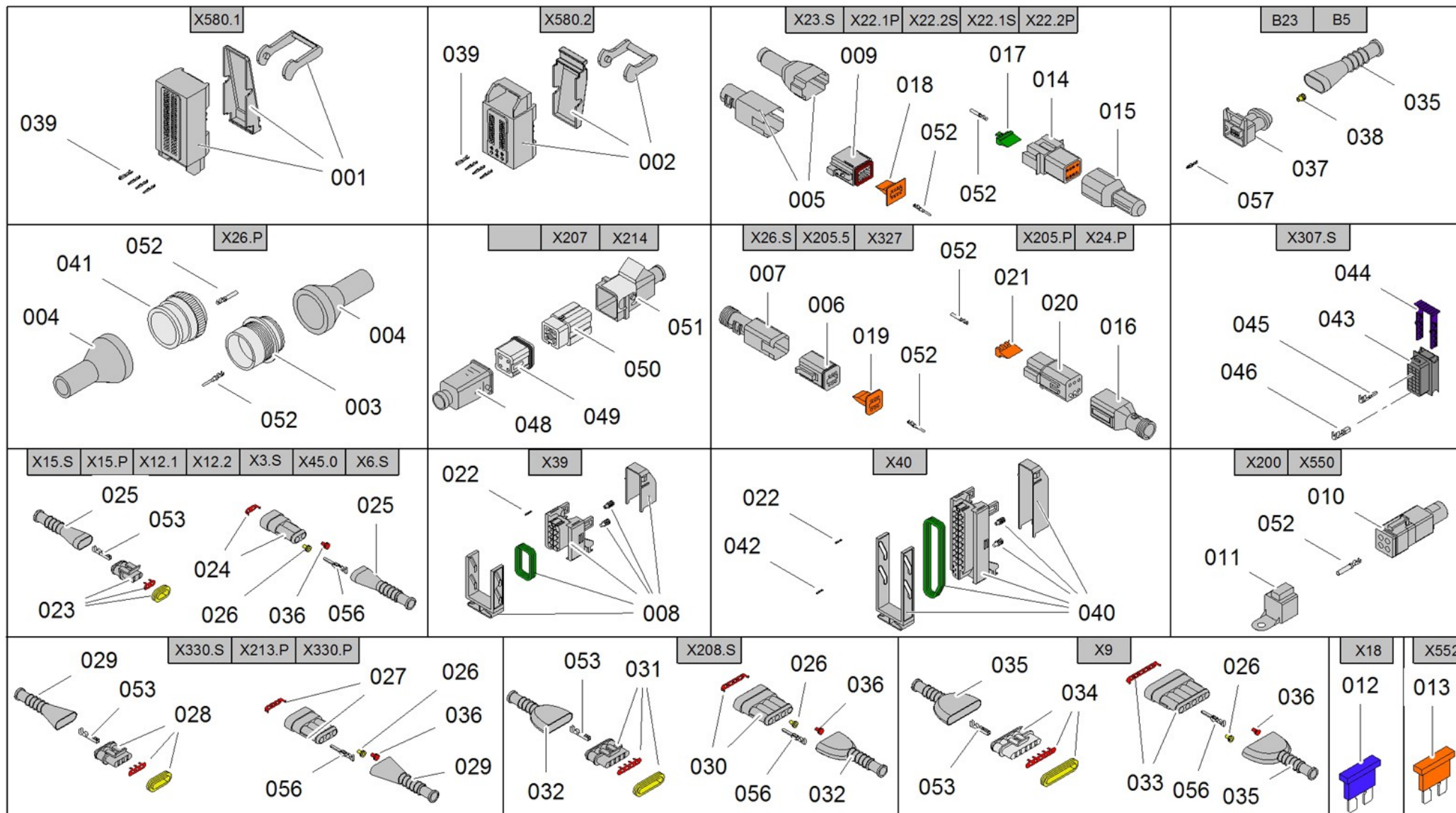

 IMPIANTO ELETTRICO  
 ELECTRICAL SYSTEM  
 INSTALLATION ÉLECTRIQUE



ELEKTRISCHE ANLAGE   
 INSTALACIÓN ELÉCTRICA 











Main color codes:  J1 - JLG Cream,  J2 - JLG Orange,  C4 - Green







 IMPIANTO ELETTRICO  
 ELECTRICAL SYSTEM  
 INSTALLATION ÉLECTRIQUE



ELEKTRISCHE ANLAGE   
 INSTALACIÓN ELÉCTRICA 



POS	Codice	 Descrizione	 Description	 Designation	 Benennung	 Descripción
1	1772950005	CONNETTORE X580.1	CONNECTOR X580.1	CONNECTEUR	VERBINDER	CONECTADOR
2	1772950006	CONNETTORE X580.2	CONNECTOR X580.2	CONNECTEUR	VERBINDER	CONECTADOR
3	1730720051	CONNETTORE 29 VIE M MOTORE (X26)	CONNECTOR	CONNECTEUR	VERBINDER	CONECTOR
4	1730720054	CAPPUCCIO POSTERIORE	CAP	CAPUCHON	KAPPE	CAPUCHO
5	1730720035	COVER POSTERIORE RIGIDA PER CONNETTORE 8 VIE MASCHIO	PROTECTION	PROTECTION	SCHUTZ	PROTECCION
5	1757250025	CAPPUCCIO POSTERIORE PER CONNETTORE MASCHIO	CAP	CAPUCHON	KAPPE	TAPA
6	1730720037	CONNETTORE 6 VIE MASCHIO	6-WAY MALE CONNECTOR	CONNECTEUR 6 VOIES MÂLE	6-WEGE-VERBINDER	CONECTOR 6 VÍAS
7	1730720039	COVER POSTERIORE RIGIDA PER CONNETTORE 6 VIE MASCHIO	PROTECTION	PROTECTION	SCHUTZ	PROTECCION
8	1772950009	CONNETTORE PER 48XS 28 POLI	CONNECTOR FOR 48XS 28P	CONNECTEUR	KLEMME	BORNE
9	1730720033	CONNETTORE 8 VIE MASCHIO	8-WAY MALE CONNECTOR	CONNECTEUR 8 VOIES MÂLE	8-WEGE-VERBINDER STIFT	CONECTOR 8 VÍAS MACHO
10	1763330001	CONNETTORE 4 VIE MASCHIO DEUTSCH	4-WAY MALE CONNECTOR DEUTSCH	CONNECTEUR 4 VOIES MÂLE DEUTSCH	4-WEGE-VERBINDER STIFT DEUTSCH	CONECTOR 4 VÍAS MACHO DEUTSCH
11	1763330002	CAPPUCCIO FRONTALE CONNETTORE 4 VIE MASCHIO DEUTSCH	CAP FOR 4-WAY MALE CONNECTOR DEUTSCH	PAC CONNECTEUR 4 VOIES MÂLE DEUTSCH	CAP 4-WEGE-VERBINDER STIFT DEUTSCH	CAP CONECTOR 4 VÍAS MACHO DEUTSCH
12	07700700	FUSIBILE A LAMA 25A	FUSE 25A	FUSIBLE 25A	SICHERUNG 25A	FUSIBLE 25A
13	05760700	FUSIBILE A LAMA 5A	FUSE 5A	FUSIBLE 5A	SICHERUNG 5A	FUSIBLE 5A



Main color codes:  J1 - JLG Cream,  J2 - JLG Orange,  C4 - Green



 IMPIANTO ELETTRICO  
 ELECTRICAL SYSTEM  
 INSTALLATION ÉLECTRIQUE





ELEKTRISCHE ANLAGE   
 INSTALACIÓN ELÉCTRICA 



POS	Codice	 Descrizione	 Description	 Designation	 Benennung	 Descripción
14	1730720029	CONNETTORE 8 VIE FEMMINA	8-WAY FEMALE CONNECTOR	CONNECTEUR 8 VOIES FEMELLE	8-WEGE-VERBINDER BUCHSE	CONECTOR 8 VÍAS HEMBRA
15	1730720031	COVER POSTERIORE RIGIDA PER CONNETTORE 8 VIE FEMMINA	PROTECTION	PROTECTION	SCHUTZ	PROTECCION
15	1757250026	CAPPUCCIO POSTERIORE PER CONNETTORE FEMMINA	CAP	CAPUCHON	KAPPE	TAPA
16	1730720084	COVER POSTERIORE RIGIDA PER CONNETTORE 6 VIE FEMMINA	PROTECTION	PROTECTION	SCHUTZ	PROTECCION
16	1757250027	CAPPUCCIO POSTERIORE PER CONNETTORE 6 VIE FEMMINA	CAP	CAPUCHON	KAPPE	TAPA
17	1730720030	PIASTRINA DI BLOCCAGGIO CONNETTORE 8 VIE FEMMINA	PLATE	PLAQUE	PLATTE	PLACA
18	1730720034	PIASTRINA DI BLOCCAGGIO CONNETTORE 8 VIE MASCHIO	PLATE	PLAQUE	PLATTE	PLACA
19	1730720038	PIASTRINA DI BLOCCAGGIO CONNETTORE 6 VIE MASCHIO	PLATE	PLAQUE	PLATTE	PLACA
20	1730720041	CONNETTORE 6 VIE FEMMINA	6-WAY FEMALE CONNECTOR	CONNECTEUR 6 VOIES FEMELLE	6-WEGE-VERBINDER BUCHSE	CONECTOR 6 VÍAS HEMBRA



Main color codes:  J1 - JLG Cream,  J2 - JLG Orange,  C4 - Green



 IMPIANTO ELETTRICO  
 ELECTRICAL SYSTEM  
 INSTALLATION ÉLECTRIQUE





ELEKTRISCHE ANLAGE   
 INSTALACIÓN ELÉCTRICA 



POS	Codice	 Descrizione	 Description	 Designation	 Benennung	 Descripción
21	1730720042	PIASTRA BLOCCAGGIO CONNETTORE 6 VIE FEMMINA	CONNECTOR	CONNECTEUR	VERBINDER	CONECTADOR
22	1772950007	PUNTALINO FEMMINA PER 48XS CAVO 0,5-1	FERRULE FEMALE 48XS 0,5-1	BORNE	KLEMME	BORNE
23	1757250031	CONNETTORE SUPERSEAL PF 2 VIE	CONNECTOR	CONNECTEUR	VERBINDER	CONECTADOR
24	1757250032	CONNETTORE SUPERSEAL PM 2 VIE	CONNECTOR	CONNECTEUR	VERBINDER	CONECTADOR
25	1757250033	CAPPUCCIO POSTERIOERE CONNETTORE SUPERSEAL 2 VIE	CAP	CAPUCHON	KAPPE	CAPUCHO
26	1757250043	GOMMINO TENUTA PER CAVI CONNETTORI SUPERSEAL	RUBBER SEAL	JOINT EN CAOUTCHOUC	GUMMIDICHTUNG	JUNTA DE GOMA
27	1757250035	CONNETTORE SUPERSEAL PM 3 VIE	CONNECTOR	CONNECTEUR	VERBINDER	CONECTADOR
28	1757250034	CONNETTORE SUPERSEAL PF 3 VIE	CONNECTOR	CONNECTEUR	VERBINDER	CONECTADOR
29	1757250036	CAPPUCCIO POSTERIOERE CONNETTORE SUPERSEAL 3 VIE	CAP	CAPUCHON	KAPPE	CAPUCHO
30	1757250038	CONNETTORE SUPERSEAL PM 4 VIE	CONNECTOR	CONNECTEUR	VERBINDER	CONECTADOR
31	1757250037	CONNETTORE SUPERSEAL PF 4 VIE	CONNECTOR	CONNECTEUR	VERBINDER	CONECTADOR



Main color codes:  J1 - JLG Cream,  J2 - JLG Orange,  C4 - Green



 IMPIANTO ELETTRICO  
 ELECTRICAL SYSTEM  
 INSTALLATION ÉLECTRIQUE





ELEKTRISCHE ANLAGE   
 INSTALACIÓN ELÉCTRICA 



POS	Codice	 Descrizione	 Description	 Designation	 Benennung	 Descripción
32	1757250039	CAPPUCCIO POSTERIORE CONNETTORE SUPERSEAL 4 VIE	CAP	CAPUCHON	KAPPE	CAPUCHO
33	1757250041	CONNETTORE SUPERSEAL PM 5 VIE	CONNECTOR	CONNECTEUR	VERBINDER	CONECTADOR
34	1757250040	CONNETTORE SUPERSEAL PF 5 VIE	CONNECTOR	CONNECTEUR	VERBINDER	CONECTADOR
34	1757250056	CONNETTORE SUPERSEAL PF 6 VIE	CONNECTOR	CONNECTEUR	VERBINDER	CONECTADOR
35	1757250042	CAPPUCCIO POSTERIOERE CONNETTORE SUPERSEAL 5 VIE	CAP	CAPUCHON	KAPPE	CAPUCHO
35	1757250057	CAPPUCCIO POSTERIOERE CONNETTORE SUPERSEAL 6-7 VIE	CAP	CAPUCHON	KAPPE	CAPUCHO
36	1757250046	GOMMINO TENUTA TAPPO PER CONNETTORI SUPERSEAL	RUBBER SEAL	JOINT EN CAOUTCHOUC	GUMMIDICHTUNG	JUNTA DE GOMA
37	1757250044	CONNETTORE JPT 2 VIE PER ELETTROVALVOLE	CONNECTOR	CONNECTEUR	VERBINDER	CONECTADOR
38	1757250045	GOMMINO TENUTA PER CAVI CONNETTORI JPT	RUBBER SEAL	JOINT EN CAOUTCHOUC	GUMMIDICHTUNG	JUNTA DE GOMA
39	17306300	PUNTALINO FEMMINA PER CONNETTORE 56 VIE SCHEDE MASTER D=1.5	FERRULE FEMALE CONNECTOR 56 WAY MAIN BOARD D = 1.5	BUTÉE FEMELLE CONNECTEUR 56 VOIES CARTE MASTER D = 1.5	AUFLAGESTIFT BUCHSE 56-WEGE- VERBINDER MASTERPLATINE D = 1.5	CONECTOR PUNTA HEMBRA 56 VÍAS TARJETA MASTER D=1,5



Main color codes:  J1 - JLG Cream,  J2 - JLG Orange,  C4 - Green



 IMPIANTO ELETTRICO  
 ELECTRICAL SYSTEM  
 INSTALLATION ÉLECTRIQUE





ELEKTRISCHE ANLAGE   
 INSTALACIÓN ELÉCTRICA 



POS	Codice	 Descrizione	 Description	 Designation	 Benennung	 Descripción
39	1772950001	PUNTALINO FEMMINA PER X580 CAVO SEZ 0,75-1	FERRULE FEMALE X580 0,75-1	BORNE	KLEMME	BORNE
40	1772950010	CONNETTORE PER 48XS 52 POLI	CONNECTOR FOR 48XS 52P	CONNECTEUR	VERBINDER	CONECTADOR
41	1730720059	CONNETTORE 29 VIE F MOTORE (X26)	CONNECTOR	CONNECTEUR	VERBINDER	CONECTADOR
42	1772950008	PUNTALINO FEMMINA PER 48XS CAVO 1,5	FERRULE FEMALE 48XS 1,5	BORNE	KLEMME	BORNE
43	17473600	PARTE DI CONNETTORE 24VIE	CONNECTOR PART 24 WAY	CONNECTEUR	VERBINGER	CONECTADOR
44	17473700	SLITTA PER CONNETTORE 24 VIE	SLIDE FOR 24-WAY CONNECTOR	COULISSEAU	SCHLITTEN	CORREDERA
46	17473800	PUNTALINO FEMMINA PER CONNETTORE 24 VIE SCHEDE CELLA DI CARICO D=2.8	FERRULE FEMALE CONNECTOR 24 WAY BOARD LOAD CELL D = 2.8	EMBOUT FEMELLE POUR CONNECTEUR 24 VOIES CARTE CELLULE DE CHARGE D=2.8	VERSCHRAUBUNG BUCHSE FÜR 24-WEGE-VERBINDER KORBLAST-PLATINE D=2,8	PUNTAL HEMBRA PARA CONECTOR 24 VÍAS CELULA DE CARGA D=2.8
49	07913200	CONNETTORE COMPLETO PM 3 VIE SOURIAU 220V	COMPLETE CONNECTOR PM 220V 3 WAYS SOURIAU	COMPLET CONNECTEUR À TROIS VOIES PM SOURIAU 220 V	KOMPLETTER 3-WEGE-ANSCHLUSS PM SOURIAU 220 V	CONECTOR COMPLETO PM 3 VÍAS SOURIAU 220 V
49	07913300	TERMINALE M X SEZIONE 1,5 PER CONNETTORE 3 VIE SOURIAU 220V	FERRULE M X SECTION 1.5 FOR CONNECTOR 3 VIE SOURIAU 220V	FERRULE M POUR SECTION 1.5 POUR CONNECTEUR 3 VOIES SOURIAU 220V	M FERRULE FÜR 1.5 ABSCHNITT FÜR 3-WEGE VERBINDER SOURIAU 220V	FÉRULA M PARA SECCIÓN 1,5 PARA CONECTOR 3 VIAS SOURIAU 220V
49	07913400	TERMINALE M X SEZIONE 2,5 PER CONNETTORE 3 VIE SOURIAU 220V	FERRULE M X SECTION 2.5 FOR CONNECTOR 3 VIE SOURIAU 220V	FERRULE M POUR SECTION 2.5 POUR CONNECTEUR 3 VOIES SOURIAU 220V	M FERRULE FÜR 2.5 ABSCHNITT FÜR 3-WEGE VERBINDER SOURIAU 220V	FÉRULA M PARA SECCIÓN 2,5 PARA CONECTOR 3 VIAS SOURIAU 220V

Main color codes:  J1 - JLG Cream,  J2 - JLG Orange,  C4 - Green



 IMPIANTO ELETTRICO  
 ELECTRICAL SYSTEM  
 INSTALLATION ÉLECTRIQUE



ELEKTRISCHE ANLAGE   
 INSTALACIÓN ELÉCTRICA 





POS	Codice	 Descrizione	 Description	 Designation	 Benennung	 Descripción
50	07913100	CONNETTORE COMPLETO PF 3 VIE SOURIAU 220V	COMPLETE CONNECTOR PF 220V 3 WAYS SOURIAU	COMPLET CONNECTEUR À TROIS VOIES PF SOURIAU 220 V	KOMPLETTER 3- WEGE-ANSCHLUSS PF SOURIAU 220 V	CONECTOR COMPLETO PF 3 VÍAS SOURIAU 220 V
50	07913500	TERMINALE F X SEZIONE 1,5 PER CONNETTORE 3 VIE SOURIAU 220V	FERRULE F X SECTION 1.5 FOR CONNECTOR 3 VIE SOURIAU 220V	FERRULE F POUR SECTION 1.5 POUR CONNECTEUR 3 VOIES SOURIAU 220V	F FERRULE FÜR 1.5 ABSCHNITT FÜR 3- WEGE VERBINDER SOURIAU 220V	FÉRULA F PARA SECCIÓN 1,5 PARA CONECTOR 3 VIAS SOURIAU 220V
50	07913600	TERMINALE F X SEZIONE 2,5 PER CONNETTORE 3 VIE SOURIAU 220V	FERRULE F X SECTION 2.5 FOR CONNECTOR 3 VIE SOURIAU 220V	FERRULE F POUR SECTION 2.5 POUR CONNECTEUR 3 VOIES SOURIAU 220V	F FERRULE FÜR 2.5 ABSCHNITT FÜR 3- WEGE VERBINDER SOURIAU 220V	FÉRULA F PARA SECCIÓN 2,5 PARA CONECTOR 3 VIAS SOURIAU 220V
52	1730720032	TERMINALE MASCHIO CAVO 0.75- 1.5	TERMINAL MALE CABLE 0.75-1.5	MALE TERMINAL	TERMINAL MALE	MALE TERMINAL
52	1730720036	TERMINALE FEMMINA CONNETTORE M CAVO 0.5-1	TERMINAL FEMALE MALE CONNECTOR CABLE 0.5-1	BORNE FEMELLE	TERMINAL FEMALE	TERMINAL HEMBRA
52	1730720040	TERMINALE FEMMINA (X24)	TERMINAL FEMALE (X24)	BORNE FEMELLE (X24)	TERMINAL FEMALE (X24)	TERMINAL HEMBRA (X24)
52	1730720043	TERMINALE MASCHIO (X24) DA 0.5 A 0.75	TERMINAL MALE (X24) DA 0.5 A 0.75	BORNE MALE (X24)	TERMINAL MALE (X24)	TERMINAL MACHO (X24)
52	1730720055	CONTATTO MASCHIO 25A CAVO 2.5-4	CONTACT MALE 25A CABLE 2.5-4	CONTACT MALE 25A	CONTACT MALE 25A	CONTACT MALE 25A
52	1730720056	TAPPO SIZE 12-16 (X26)	CAP SIZE 12-16 (X26)	CAP TAILLE 12-16 (X26)	CAP SIZE 12-16 (X26)	CAP TAMAÑO 12-16 (X26)
52	1730720057	TAPPO SIZE 16 (X26)	CAP SIZE 16 (X26)	PLUG SIZE 16 (X26)	PLUG SIZE 16 (X26)	MACHO TALLA 16 (X26)
52	1730720058	CONTATTO MASCHIO 7.5A (X26)	CONTACT PIN 7.5A (X26)	CONTACT PIN 7.5A (X26)	CONTACT PIN 7.5A (X26)	CONTACT 7.5A (X26)
52	1730720061	CONTATTO FEMMINA 7.5A (X26)	CONTACT FEMALE 7.5A (X26)	CONTACTER 7,5 FEMELLE (X26)	CONTACT FEMALE 7.5A (X26)	CONTACT 7.5A FEMENINO (X26)



Main color codes:  J1 - JLG Cream,  J2 - JLG Orange,  C4 - Green





 IMPIANTO ELETTRICO  
 ELECTRICAL SYSTEM  
 INSTALLATION ÉLECTRIQUE



ELEKTRISCHE ANLAGE   
 INSTALACIÓN ELÉCTRICA 



POS	Codice	 Descrizione	 Description	 Designation	 Benennung	 Descripción
52	1730720068	TAPPO SIZE 20 (X1)	CAP SIZE 20 (X1)	PLUG SIZE 20 (X1)	PLUG SIZE 20 (X1)	TAMAÑO DE ENCHUFE 20 (X1)
52	1730720069	CONTATTO FEMMINA 25A CONNETTORE M CAVO 2.5-4	CONTACT FEMALE 25A MALE CONNECTOR CABLE 2.5-4	CONTACT FEMELLE 25A	KONTAKT BUCHSE 25A	CONTACT HEMBRA 25A
56	1757250049	PUNTALINO MASCHIO PER SUPERSEAL	FERRULE MALE FOR SUPERSEAL	FERRULE	NUTMUTTER	ANILLO
57	1739150047	CONTATTO FEMMINA PER CONNETTORE JPT	CONTACT FEMALE FOR CONNECTOR JPT	CONTACT FEMELLE POUR CONNECTEUR JPT	KONTAKT BUCHSE FÜR JPT VERBINDER	CONTACTO HEMBRA PARA CONECTOR JPT
58	1757250048	PUNTALINO FEMMINA PER SUPERSEAL	FERRULE FEMALE FOR SUPERSEAL	FERRULE	NUTMUTTER	ANILLO

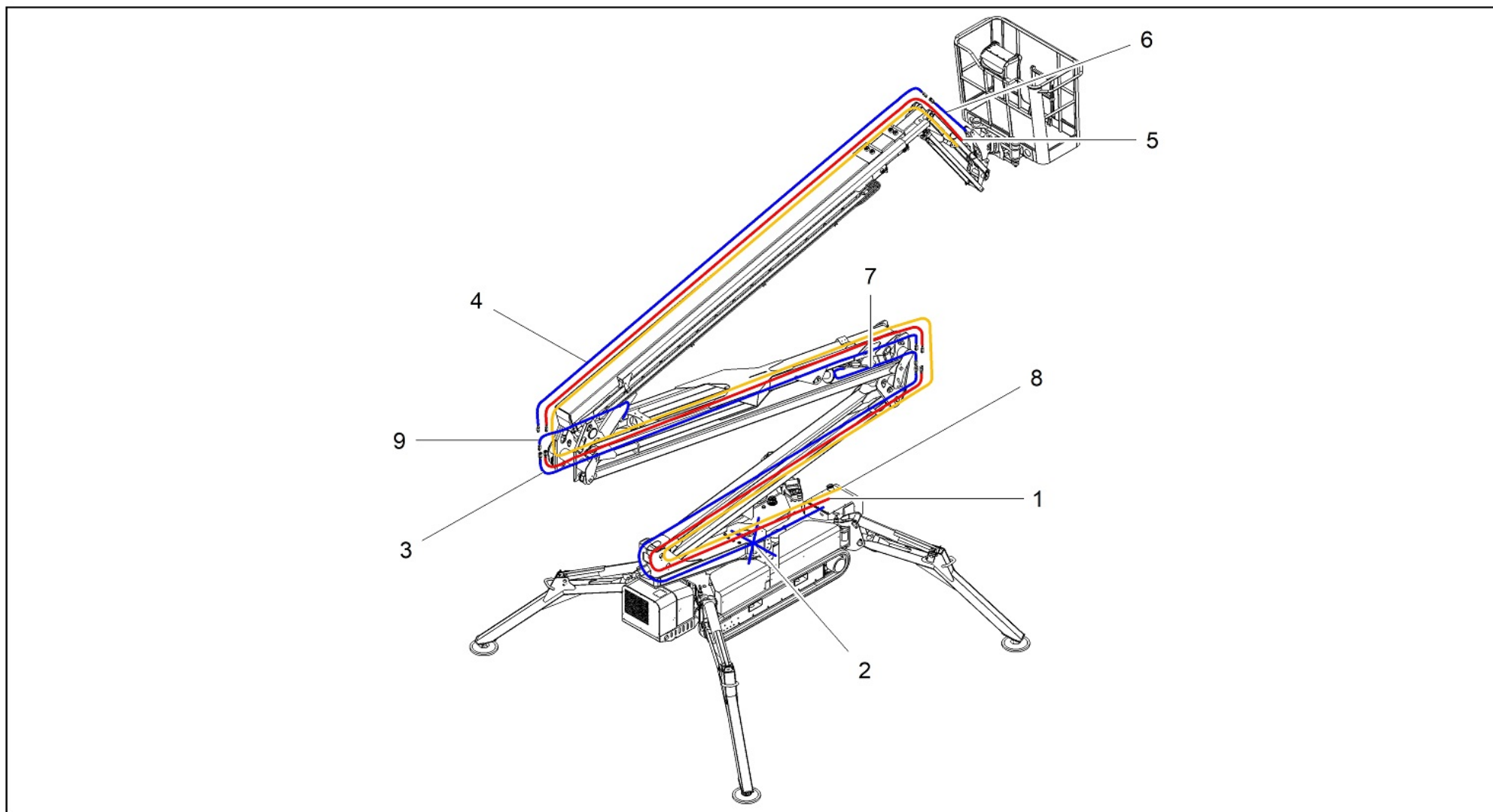

 IMPIANTO ELETTRICO  
 ELECTRICAL SYSTEM  
 INSTALLATION ÉLECTRIQUE





ELEKTRISCHE ANLAGE   
INSTALACIÓN ELÉCTRICA 







Main color codes:  J1 - JLG Cream,  J2 - JLG Orange,  C4 - Green

 IMPIANTO ELETTRICO  
 ELECTRICAL SYSTEM  
 INSTALLATION ÉLECTRIQUE



ELEKTRISCHE ANLAGE   
 INSTALACIÓN ELÉCTRICA 

POS	Codice	 Descrizione	 Description	 Designation	 Benennung	 Descripción
1	1770760003	CAVO PROLUNGA 220-110V DA BASE A PRIMO BRACCIO LL2614 TTC CONNETTORI SOURIAU (DA SN C170001340)	EXTENSION CABLE 220-110V FROM BASE TO FIRST BOOM LL2614 TTC CONNECTORS SOURIAU (FROM SN C170001340)	CÂBLE	KABEL	CABLE
2	17707400	KIT ELE GENERALE LL2614 T	WIRING KIT LL2614 T	KIT DE CABLAGE LL2614 T	KABELSATZ LL2614 T	KIT DE CABLEADO LL2614T
3	1770760002	CAVO PROLUNGA 7POLI DA 1 BRACCIO A 3 BRACCIO LL2614	EXTENSION CABLE 7WAY FROM 1 BOOM TO 3 BOOM LL2614	CÂBLE	KABEL	CABLE
4	1770760001	CAVO PROLUNGA 7 POLI SFILO LL2614 TTC (DA SN C170001340)	CABLE 7 POLES EXTENSION LL2614 TTC (FROM SN C170001340)	CÂBLE	KABEL	CABLE
5	1770740002	LINEA 220V BRACCIO SFILO LL2614-X26JP-X770AJ (DA SN C170001340)	LINE EXTENSION ARM 220V LL2614-X26JP-X770AJ (FROM SN C170001340)	LIGNE 220V	LEITUNG 220V	LÍNEA 220V
6	1770760004	KIT ELETTRICO JIB LL2614-X26JP-X770AJ TTC (DA SN C170001340)	ELECTRIC KIT JIB LL2614-X26JP-X770AJ TTC (FROM SN C170001340)	CÂBLE	KABEL	CABLE
7	1770740005	LINEA SENSORE CILINDRO TERZO BRACCIO LL2614-X26JP-X770AJ	FIRST AND SECOND ARM CYLINDER SENSOR LINE LL2614-X26JP-X770AJ	LIGNE	LEITUNG	LÍNEA

 IMPIANTO ELETTRICO DIESEL  
 ELECTRICAL SYSTEM DIESEL  
 INSTALLATION ÉLECTRIQUE DIESEL

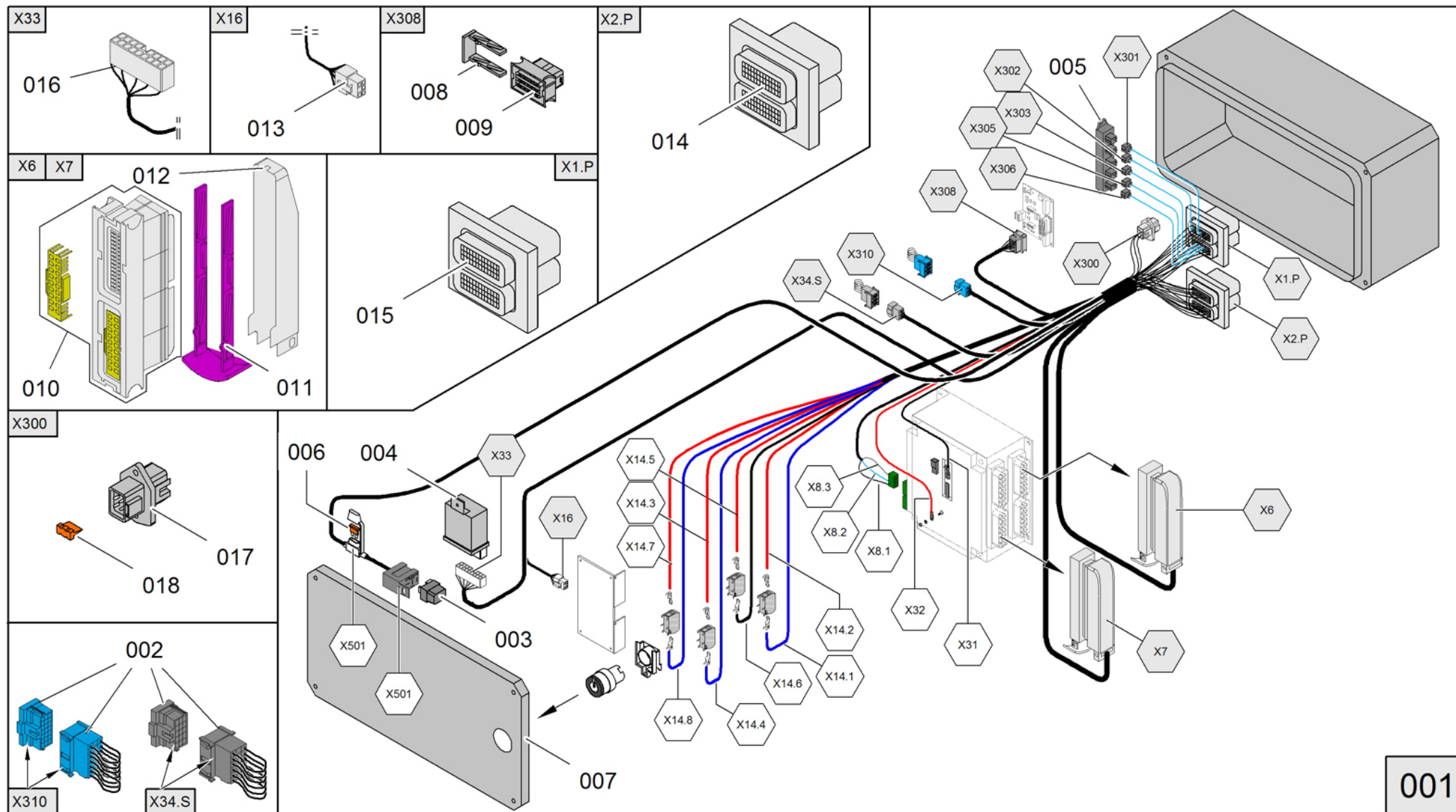
ELEKTRISCHE ANLAGE DIESEL   
 INSTALACIÓN ELÉCTRICA DIESEL 









Main color codes:  J1 - JLG Cream,  J2 - JLG Orange,  C4 - Green



 IMPIANTO ELETTRICO DIESEL

 ELECTRICAL SYSTEM DIESEL

 INSTALLATION ÉLECTRIQUE DIESEL

 ELEKTRISCHE ANLAGE DIESEL   
 INSTALACIÓN ELÉCTRICA DIESEL 





POS	Codice	 Descrizione	 Description	 Designation	 Benennung	 Descripción
1	17739800	KIT ELE INTEGRAZIONE MOTORE DIESEL LL2614 T	INTEGRATION WIRING KIT DIESEL ENGINE LL2614 T	KIT INTEGRATION DE CABLAGE MOTEUR DIESEL LL2614 T	KABELINTEGRATION SSATZ DIESELMOTOR LL2614 T	KIT INTEGRACION DE CABLEADO MOTOR DIESEL LL2614 T
2	2734250015	TIMER SPEGNIMENTO PER MOTORE Z602 D902	TIMER ENGINE STOP Z602 D902	TEMPORISATEUR POUR MOTEUR Z602 D902	TIMER FÜR MOTOR Z602 D902	TEMPORIZADOR PARA MOTOR Z602 D902
3	1733730003	RELE' CANDELETTE E STOP MOTORE	RELAY 'GLOW AND STOP ENGINE	RELAIS PETITE BOUGIE ET ARRÊT MOTEUR	RELAIS ZÜNDKERZEN UND MOTOR-STOPP	RELÉ BUJÍAS PEQUEÑAS Y STOP MOTOR
4	1739150056	RELE' PER MONTAGGIO INTERNO SCATOLA 12V CON DIODO AVVIAMENTO MOTORE	RELAY 'FOR INTERNAL MOUNTING BOX WITH DIODE 12V STARTER MOTOR	RELAIS POUR MONTAGE INTÉRIEUR BOÎTIER 12V AVEC DIODE DÉMARRAGE MOTEUR	RELAIS	RELÉ PARA MONTAJE INTERNO CAJA 12V CON DIODO ARRANQUE MOTOR
5	05760900	FUSIBILE 10A	FUSE 10A	FUSIBLE 10A	SICHERUNG 10A	FUSIBLE 10A
6	05761000	FUSIBILE A LAMA 15A	FUSE 15A	FUSIBLE 15A	SICHERUNGSDRAHT 15A	FUSIBLE 15A
7	1739150058	FUSIBILE A LAMA DA 50A	FUSE BLADE 50A	FUSIBLE À LAME 50A	50 A SICHERUNG	FUSIBILE A LAMA 50A
8	1733730031	PORTAFUSIBILE MAXI COMPLETO	COMPLETE MAXI FUSE HOLDER	PORTE-FUSIBLES MAXI COMPLET	SICHERUNGSHALTER KOMPLETT (XE0804611+XE0804621 + XE0804622)	PORTAFUSIBILE MAXI COMPLETO
9	05434500	STAFFA PER SUPPORTO RELE'	BRACKET SUPPORT RELAY '	BRIDE	BÜGEL	BRIDA
11	1757260002	TAPPO CONNETTORE YAZAKI 2 VIE CON DIODO 2.5A	PLUG	BOUCHON	DECKEL	TAPA
12	1733730010	CONNETTORE PORTA FEMMINE 3 VIE ALTERNATORE	CONNECTOR 3 WAY FEMALE HOLDER, ALTERNATOR	CONNECTEUR PORTE FEMELLES 3 VOIES ALTERNATEUR	3-WEGE-VERBINDER	CONECTOR PORTA HEMBRAS 3 VÍAS ALTERNADOR

 Main color codes:  J1 - JLG Cream,  J2 - JLG Orange,  C4 - Green

 IMPIANTO ELETTRICO DIESEL

 ELECTRICAL SYSTEM DIESEL

 INSTALLATION ÉLECTRIQUE DIESEL
ELEKTRISCHE ANLAGE DIESEL INSTALACIÓN ELÉCTRICA DIESEL 

POS	Codice	 Descrizione	 Description	 Designation	 Benennung	 Descripción
13	1733730008	CONNETTORE PORTA FEMMINE 4 VIE X11	CONNECTOR WITH FEMALE TERMINAL 4 VIE X11	CONNECTEUR AVEC PORTE FEMELLE 4 VOIES X11	4-WEGE VERBINDER	CONECTOR PORTA HEMBRAS 4 VÍAS X11
14	1757260003	PORTA RELE' DI POTENZA 70A	RELAY HOLDER	PORTE-RELAIS	RELAISHALTER	PORTARELÉ
15	1757260004	PORTA RELE' MINI	RELAY HOLDER	PORTE RELAIS	RELAISHALTER	PORTARELÉ
16	1730720059	CONNETTORE 29 VIE F MOTORE (X26)	CONNECTOR	CONNECTEUR	VERBINDER	CONECTADOR









ADESIVI

STICKER

AUFKLEBER 

PEGATINA 

# DECALS LIST





Main color codes:  **J1** - JLG Cream,  **J2** - JLG Orange,  **C4** - Green





ADESIVI





STICKER



AUFKLEBER PEGATINA 

POS	Codice	 Descrizione	 Description	 Designation	 Benennung	 Descripción
0	06039600	ADESIVO	STICKER	AUTOCOLLANT	AUFKLEBER	PEGATINA
0	06039700	ADESIVO	STICKER	AUTOCOLLANT	AUFKLEBER	PEGATINA
0	06039900	ADESIVO	STICKER	AUTOCOLLANT	AUFKLEBER	PEGATINA
0	06040300	ADESIVO	STICKER	AUTOCOLLANT	AUFKLEBER	PEGATINA
0	06040500	ADESIVO	STICKER	AUTOCOLLANT	AUFKLEBER	PEGATINA
0	06040900	ADESIVO	STICKER	AUTOCOLLANT	AUFKLEBER	PEGATINA
0	06041200	ADESIVO	STICKER	AUTOCOLLANT	AUFKLEBER	PEGATINA
0	06041300	ADESIVO	STICKER	AUTOCOLLANT	AUFKLEBER	PEGATINA
0	06042400	ADESIVO	STICKER	AUTOCOLLANT	AUFKLEBER	PEGATINA
0	06056300	ADESIVO	STICKER	AUTOCOLLANT	AUFKLEBER	PEGATINA
0	06060000	ADESIVO	STICKER	AUTOCOLLANT	AUFKLEBER	PEGATINA
0	06085900	ADESIVO	STICKER	AUTOCOLLANT	AUFKLEBER	PEGATINA
0	06086000	ADESIVO	STICKER	AUTOCOLLANT	AUFKLEBER	PEGATINA
0	06086700	ADESIVO	STICKER	AUTOCOLLANT	AUFKLEBER	PEGATINA
0	06136900	ADESIVO PUNTI INGRASSAGGIO Ø 55 TESTO NERO - SFONDO BIANCO (**)	STICKER GREASE POINTS Ø 55	AUTOCOLLANT POINTS GRAISSANGE Ø 55 TEXTE NOIR - FOND BLANC (**)	AUFKLEBER SCHMIERPUNKTE Ø 55, SCHWARZER TEXT - WEIßER UNTERGRUND	PEGATINS PUNTOS ENGRASE Ø 55 TEXTO NEGRO - FONDO BLANCO (**)
0	06164600	ADESIVO	STICKER	AUTOCOLLANT	AUFKLEBER	PEGATINA
0	06164700	ADESIVO	STICKER	AUTOCOLLANT	AUFKLEBER	PEGATINA
0	06165000	ADESIVO	STICKER	AUTOCOLLANT	AUFKLEBER	PEGATINA
0	06214200	ADESIVO	STICKER	AUTOCOLLANT	AUFKLEBER	PEGATINA
0	06227200	ADESIVO "CONTROLLARE LIVELLO OLIO MOTORE " 7 LINGUE GIALLO L=82X108 (**)	DECAL	AUTOCOLLANT	AUFKLEBER	PEGATINA
0	06254800	ADESIVO" STOP EMERGENZA" SFONDO GIALLO L=100X50 (**)	DECAL	AUTOCOLLANT	AUFKLEBER	PEGATINA
0	06448100	ADESIVO	STICKER	AUTOCOLLANT	AUFKLEBER	PEGATINA

Main color codes:  J1 - JLG Cream,  J2 - JLG Orange,  C4 - Green

 ADESIVI STICKERAUFKLEBER PEGATINA 

POS	Codice	 Descrizione	 Description	 Designation	 Benennung	 Descripció
0	06448200	ADESIVO	STICKER	AUTOCOLLANT	AUFKLEBER	PEGATINA
0	06506400	ADESIVO	STICKER	AUTOCOLLANT	AUFKLEBER	PEGATINA
0	06520600	ADESIVO	STICKER	AUTOCOLLANT	AUFKLEBER	PEGATINA
0	06555500	ADESIVO	STICKER	AUTOCOLLANT	AUFKLEBER	PEGATINA
0	06555600	ADESIVO	STICKER	AUTOCOLLANT	AUFKLEBER	PEGATINA
0	06555700	ADESIVO	STICKER	AUTOCOLLANT	AUFKLEBER	PEGATINA
0	06555800	ADESIVO	STICKER	AUTOCOLLANT	AUFKLEBER	PEGATINA
0	06561200	ADESIVO	STICKER	AUTOCOLLANT	AUFKLEBER	PEGATINA
0	06704400	ADESIVO REGOLAZIONE PATTINI SFILO L=120X60 BIANCO (**)	DECAL	AUTOCOLLANT	AUFKLEBER	PEGATINA
0	06706500	ADESIVO	STICKER	AUTOCOLLANT	AUFKLEBER	PEGATINA
0	06713600	ADESIVO	DECAL	AUTOCOLLANT	AUFKLEBER	PEGATINA
0	06840400	ADESIVO	STICKER	AUTOCOLLANT	AUFKLEBER	PEGATINA
0	06840700	ADESIVI PULSANTI TELECOMANDO LL23.123S - 15 PEZZI	DECALS	AUTOCOLLANTS	AUFKLEBER	PEGATINAS
0	06998800	ADESIVO	STICKER	AUTOCOLLANT	AUFKLEBER	PEGATINA
0	07034200	ADESIVO	STICKER	AUTOCOLLANT	AUFKLEBER	PEGATINA
0	07056400	ADESIVO	STICKER	AUTOCOLLANT	AUFKLEBER	PEGATINA
0	07056700	ADESIVO	STICKER	AUTOCOLLANT	AUFKLEBER	PEGATINA
0	07056800	ADESIVO	STICKER	AUTOCOLLANT	AUFKLEBER	PEGATINA
0	07058800	ADESIVO	STICKER	AUTOCOLLANT	AUFKLEBER	PEGATINA
0	07060500	ADESIVO	STICKER	AUTOCOLLANT	AUFKLEBER	PEGATINA
0	07071000	ADESIVO	STICKER	AUTOCOLLANT	AUFKLEBER	PEGATINA
0	07071200	ADESIVO	STICKER	AUTOCOLLANT	AUFKLEBER	PEGATINA
0	07194400	ADESIVO	DECAL	AUTOCOLLANT	AUFKLEBER	PEGATINA
0	07240300	ADESIVO	STICKER	AUTOCOLLANT	AUFKLEBER	PEGATINA

Main color codes:  J1 - JLG Cream,  J2 - JLG Orange,  C4 - Green

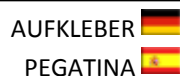

POS	Codice	Descrizione	Description	Designation	Benennung	Descripció
0	07264700	ADESIVO INDICATORE LED CARICABATTERIE 48V (Ø EST.31MM Ø INT.6 MM) VECCHIO BMS (FINO A C170000329)	DECAL	AUTOCOLLANT	AUFKLEBER	PEGATINA
0	07264800	ADESIVO	DECAL	AUTOCOLLANT	AUFKLEBER	PEGATINA
0	07268300	ADESIVO	DECAL	AUTOCOLLANT	AUFKLEBER	PEGATINA
0	07268400	ADESIVO	DECAL	AUTOCOLLANT	AUFKLEBER	PEGATINA
0	07350300	ADESIVO	DECAL	AUTOCOLLANT	AUFKLEBER	PEGATINA
0	07394800	ADESIVO INDICATORE LED CARICABATTERIE 48V (Ø EST.31MM Ø INT.6 MM) NUOVO BMS/4 (DA C170000330)	DECAL	AUTOCOLLANT	AUFKLEBER	PEGATINA
0	07499300	ADESIVO DON'T OPEN THE CASE SFONDO GIALLO L=60X17 MM	DECAL	AUTOCOLLANT	AUFKLEBER	PEGATINA
0	07633800	ADESIVO	DECAL	AUTOCOLLANT	AUFKLEBER	PEGATINA
0	07633900	ADESIVO	DECAL	AUTOCOLLANT	AUFKLEBER	PEGATINA
0	076358GB	ADESIVO	DECAL	AUTOCOLLANT	AUFKLEBER	PEGATINA
0	07667000	ADESIVO JLG PORTATA CESTO 2 PERSONE X26JPLUS L=135X145 MM	DECAL	AUTOCOLLANT	AUFKLEBER	PEGATINA
0	07668000	ADESIVO PERICOLO 110 VOLT 32A GIALLO	DECAL	AUTOCOLLANT	AUFKLEBER	PEGATINA
0	07668100	ADESIVO PULSANTI DISTRIBUTORE PARTE AEREA LL2614 L=318X52 MM	DECAL	AUTOCOLLANT	AUFKLEBER	PEGATINA

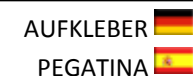









POS	Codice	Descrizione	Description	Designation	Benennung	Descripción
0	07668200	ADESIVO EMERGENCY STOP E BLOCCHETTO ACCENSIONE L=85X160 MM	DECAL	AUTOCOLLANT	AUFKLEBER	PEGATINA
0	07668300	ADESIVO	DECAL	AUTOCOLLANT	AUFKLEBER	PEGATINA
0	07668400	ADESIVO	DECAL	AUTOCOLLANT	AUFKLEBER	PEGATINA
0	07677500	ADESIVO	DECAL	AUTOCOLLANT	AUFKLEBER	PEGATINA
0	07678300	ADESIVO	DECAL	AUTOCOLLANT	AUFKLEBER	PEGATINA
0	07690100	ADESIVO	DECAL	AUTOCOLLANT	AUFKLEBER	PEGATINA
0	07691500	ADESIVO	DECAL	AUTOCOLLANT	AUFKLEBER	PEGATINA
0	07878400	ADESIVO CASCO IMBRAGATURA E DIVIETI LL1370 L=175X118 MM	STICKER HELMET HARNESS AND BANS	AUTOCOLLANT CASQUE HARNAIS ET INTERDICTION	STICKER HELMGURT UND VERBOTE	ETIQUETA ARNÉS CASCO Y PROHIBICIONES
0	08069800	ADESIVO	STICKER	AUTOCOLLANT	AUFKLEBER	PEGATINA
0	080760GB	ADESIVO	STICKER	AUTOCOLLANT	AUFKLEBER	PEGATINA
0	08294800	ADESIVO	DECAL	AUTOCOLLANT	AUFKLEBER	PEGATINA
0	08347400	STRISCIA BIANCA E ROSSA	DECAL	AUTOCOLLANT	AUFKLEBER	PEGATINA
0	08347500	STRISCIA BIANCA E ROSSA	DECAL	AUTOCOLLANT	AUFKLEBER	PEGATINA
0	1001125483	ADESIVO	STICKER	AUTOCOLLANT	AUFKLEBER	PEGATINA
0	1001223055	ADESIVO ISPEZIONE ANNUALE	DECAL YEARLY INSPECTION	INSPECTION ANNUELLE DES DÉCALQUES	AUFKLEBER JAHRESKONTROLLE	INSPECCIÓN ANUAL DE LA CALCOMANÍA
0	1001223453	ADESIVO NORMATIVA CANADESE ICES-002	CANADIAN REGULATIONS DECAL ICES-002	AUTOCOLLANT RÉGLEMENTAIRE CANADIEN ICES-002	KANADISCHE VORSCHRIFT AUFKLEBER	PEGATINA REGULATORIO CANADIENSE
0	1001228370	ADESIVO NORMATIVA CANADESE ICES-001	CANADIAN REGULATIONS DECAL ICES-001	AUTOCOLLANT RÉGLEMENTAIRE CANADIEN ICES-001	KANADISCHE VORSCHRIFTEN AUFKLEBER ICES-001	PEGATINA REGULATORIO CANADIENSE ICES- 001
0	1608710001	ADESIVO	STICKER	AUTOCOLLANT	AUFKLEBER	PEGATINA

Main color codes: J1 - JLG Cream, J2 - JLG Orange, C4 - Green



 ADESIVI STICKERAUFKLEBER PEGATINA 

POS	Codice	 Descrizione	 Description	 Designation	 Benennung	 Descripción
0	1608710002	ADESIVO	STICKER	AUTOCOLLANT	AUFKLEBER	PEGATINA
0	1701504	ADESIVO	STICKER	AUTOCOLLANT	AUFKLEBER	PEGATINA
0	1701505	ADESIVO	STICKER	AUTOCOLLANT	AUFKLEBER	PEGATINA
0	1701640	ADESIVO	STICKER	AUTOCOLLANT	AUFKLEBER	PEGATINA
0	1701644	ADESIVO JLG CAVO CARICABATTERIA	STICKER JLG CABLE CHARGER	AUTOCOLLANT	AUFKLEBER	PEGATINA
0	1702155	ADESIVO	STICKER	AUTOCOLLANT	AUFKLEBER	PEGATINA
0	1703813	ADESIVO	STICKER	AUTOCOLLANT	AUFKLEBER	PEGATINA
0	1703814	ADESIVO	STICKER	AUTOCOLLANT	AUFKLEBER	PEGATINA
0	1704125	ADESIVO	DECAL	AUTOCOLLANT	AUFKLEBER	PEGATINA
0	1704277	ADESIVO	STICKER	AUTOCOLLANT	AUFKLEBER	PEGATINA
0	1705828	ADESIVO	STICKER	AUTOCOLLANT	AUFKLEBER	PEGATINA
0	1706098	ADESIVO	STICKER	AUTOCOLLANT	AUFKLEBER	PEGATINA
0	1706385	ADESIVO	STICKER	AUTOCOLLANT	AUFKLEBER	PEGATINA
0	1706493	ADESIVO	STICKER	AUTOCOLLANT	AUFKLEBER	PEGATINA
0	1848760001	ADESIVO PER MACCHINE CON OLIO BIODEGRADABILE	STICKER FOR MACHINES WITH OIL BIODEGRADABLE	AUTOCOLLANT	AUFKLEBER	PEGATINA

Main color codes:  J1 - JLG Cream,  J2 - JLG Orange,  C4 - Green

# Cod. 17107300

**KIT INTEGRAZIONE ADESIVI PER PIATTAFORME AEREE LITHIUM-ANSI**  
*INTEGRATION KIT STICKERS PLATFORMS LITHIUM-ANSI*

**X370AJ • X390AJ • X430AJ • X500AJ • X550AJ • X600AJ • X700AJ • X770AJ**

**Da usare in aggiunta ai seguenti kit di sicurezza /**  
*To use in addition to the following safety kit*

**X370AJ .....cod.17788300**  
**X390AJ .....cod.17065200**  
**X430AJ.....cod.17788300**  
**X500AJ / MK2.....cod. 17776800**  
**X550AJ.....cod. 17065300**  
**X600AJ / MK2.....cod. 17777000**  
**X700AJ.....cod. 17065400**  
**X770AJ.....cod. 17633600**

**+ kit in lingua non inclusi nel codice generale / language code not included in the standard kit**

**+171073GB + 171073FR + 171073ES + 171073PT**





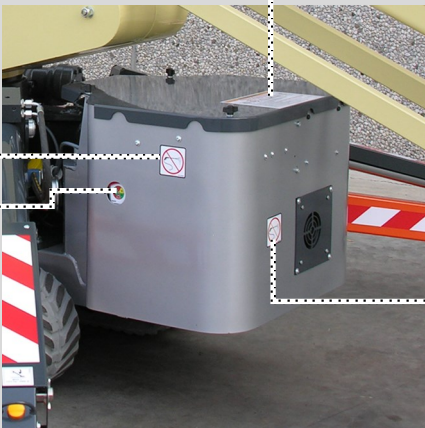

KIT ADESIVI - X390AJ

SET OF DECALS - X390AJ

KIT COLLANTS - X390AJ

AUFKLEBERSATZ - X390AJ

KIT ADHESIVOS - X390AJ

ADHESIEKIT - X390AJ

**cod. 17107300**

**Tav 01**





11

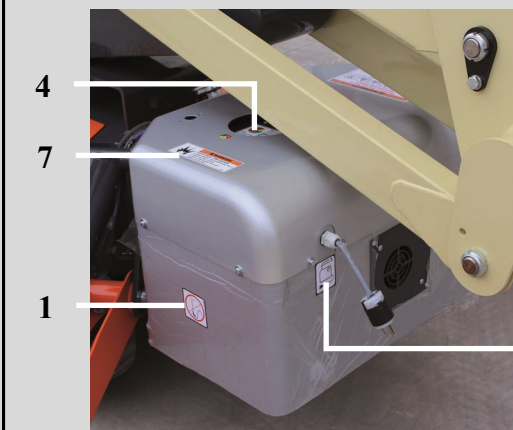

6



8

2

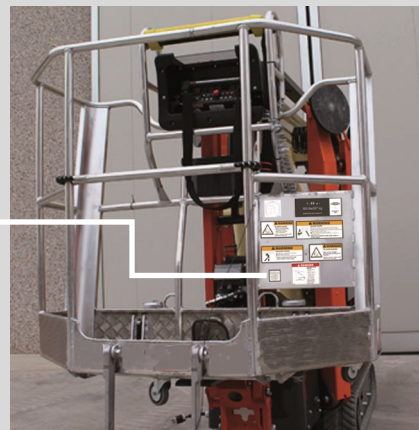

10

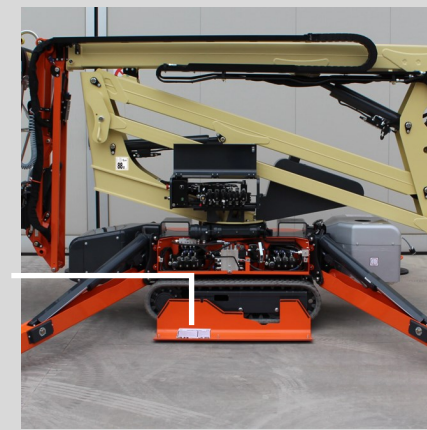

KIT ADESIVI - X370AJ / X430AJ

SET OF DECALS - X370AJ / X430AJ

KIT COLLANTS - X370AJ / X430AJ

AUFKLEBERSATZ - X370AJ / X430AJ

KIT ADHESIVOS - X370AJ / X430AJ

ADHESIEKIT - X370AJ / X430AJ

**cod. 17107300**

**Tav 01**





11

3

3

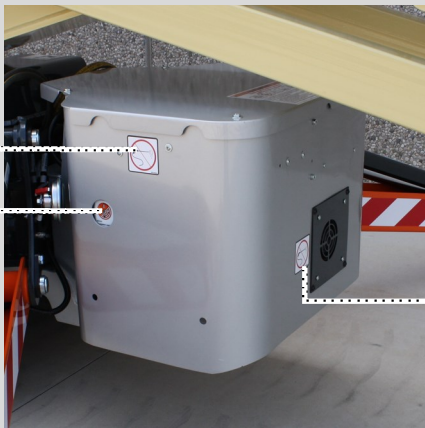

1

4

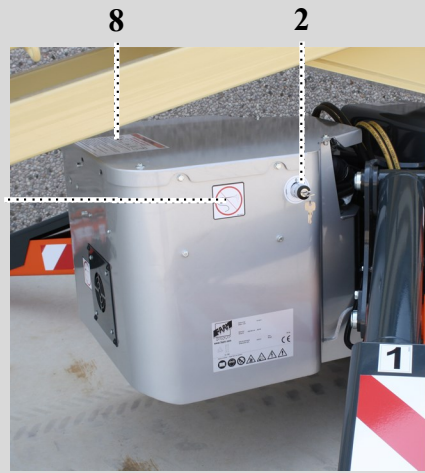

8

2

1

1

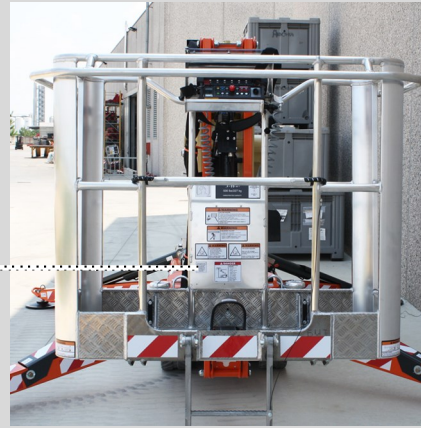

9

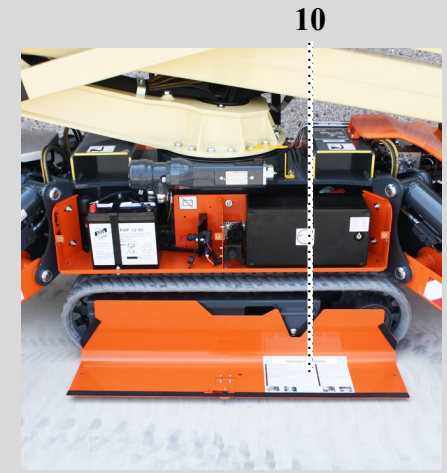

10

KIT ADESIVI - X500AJ

SET OF DECALS - X500AJ

KIT COLLANTS - X500AJ

AUFKLEBERSATZ - X500AJ

KIT ADHESIVOS - X500AJ

ADHESIEKIT - X500AJ

**cod. 17107300**

**Tav 01**





Sotto il coperchio /  
under the cover



KIT ADESIVI - X600AJ

SET OF DECALS - X600AJ

KIT COLLANTS - X600AJ

AUFKLEBERSATZ - X600AJ

KIT ADHESIVOS - X600AJ

ADHESIEKIT - X600AJ

**cod. 17107300**

**Tav 01**





11

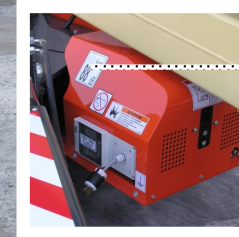

Sotto il coperchio /  
under the cover

3

3



8



2

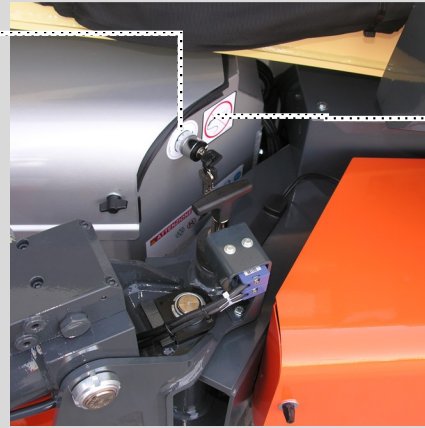

1

9

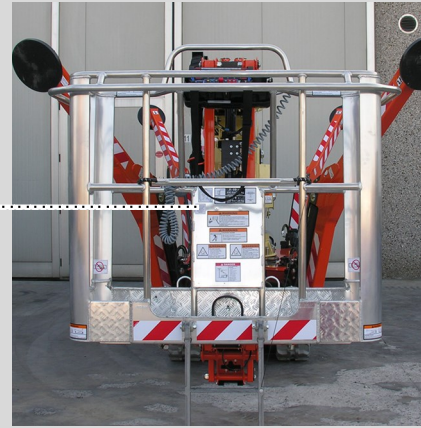

5 5 1

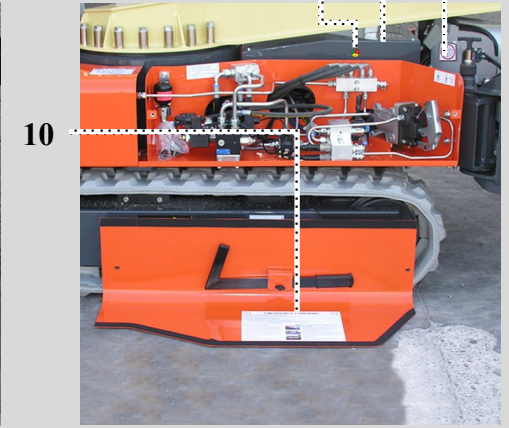

10

KIT ADESIVI - X700AJ

SET OF DECALS - X700AJ

KIT COLLANTS - X700AJ

AUFKLEBERSATZ - X700AJ

KIT ADHESIVOS - X700AJ

ADHESIEKIT - X700AJ

**cod. 17107300**

**Tav 01**





Sotto il coperchio /  
under the cover

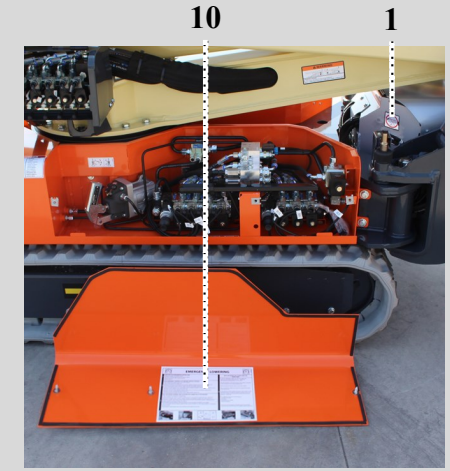
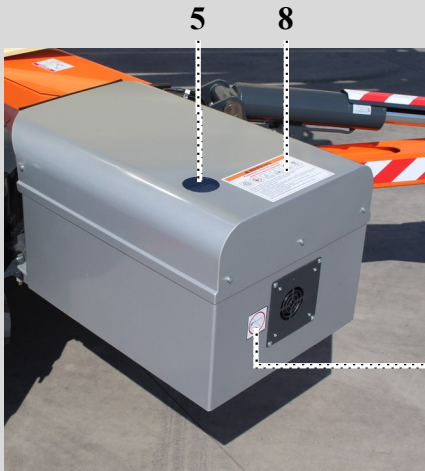

KIT ADESIVI - X770AJ

SET OF DECALS - X770AJ

KIT COLLANTS - X770AJ

AUFKLEBERSATZ - X770AJ

KIT ADHESIVOS - X770AJ

ADHESIEKIT - X770AJ

**cod. 17107300**

**Tav 01**

POS.	COD.	DESCRIZIONE / DESCRIPTION	Q.tà
01	1001125483	ADESIVO JLG VIETATO LAVARE L=63,5X63,5 MM	03
02	06506400	ADESIVO " CHIAVE DI ACCENSIONE" ESTERNO Ø 49 FORO Ø 22 SERIE LITHIUM ION <b>_MOD_B (**)</b>	01
03	06520600	ADESIVO RUMORE 88 dB L=90x100 MM <b>_MOD_B (**)</b>	02
04	07264700	ADESIVO INDICATORE LED CARICABATTERIE 48V (Ø EST.31MM Ø INT.6 MM) VECCHIO BMS (FINO A C170000329)	01
	07394800	ADESIVO INDICATORE LED CARICABATTERIE 48V (Ø EST.31MM Ø INT.6 MM) NUOVO BMS/4 (DA C170000330)	01
05	07264800	ADESIVO INDICATORE LED RICARICA BATTERIE Ø EST.21MM Ø INT.4 MM	02
06	1701644	ADESIVO JLG CAVO CARICABATTERIA L: 50,8X63,5 MM	01
07	1703813	ADESIVO JLG PERICOLO ESPLOSIONE BATTERIE - ING L=149,25X47,62 MM	01
08			
09			
10			
11	07194400	ADESIVO BOLLINO PER TELECOMANDO SERE IIIS COLORE GRIGIO Ø 10,50 MM	03
12			
13			
14			
15			
16			
17			
18			
19			
20			
21			



## **Cod. 17187700**

**KIT INTEGRAZIONE ADESIVI PER PIATTAFORME AEREE LITHIUM-CE /**  
*INTEGRATION KIT STICKERS PLATFORMS LITHIUM-CE*

**X14J - X17J - X19J - X23J**

**X13JPLUS - X15JPLUS - X17JPLUS - X20JPLUS - X26JPLUS**

**Da usare in aggiunta a / To use in added to**

**X14J - cod.17063500**

**X14J-H - cod.17065000**

**X17J cod.17063700**

**X19J cod.17063200**

**X23J cod.17062700**

**X13JPLUS cod. 17788100**

**X15JPLUS cod. 17788100**

**X17JPLUS cod. 17242800**

**X20JPLUS cod. 17351800**

**X26JPLUS cod. 17633400**

**+ kit in lingua non inclusi nel codice generale + language code not included in the standard kit**

**171877IT / 171877GB / 171877FR / 171877DE / 171877ES / 171877NL / 171877SW / 171877PT /**  
**171877DA / 171877NO / 171877RU / 171877PL / 171877SL / 171877FI / 171877CE / 171877JA**







KIT ADESIVI X14J LITHIUM  
 SET OF DECALS X14J LITHIUM  
 KIT COLLANTS X14J LITHIUM

AUFKLEBERSATZ X14J LITHIUM  
 KIT ADHESIVOS X14J LITHIUM  
 ADHESIEKIT X14J LITHIUM

**cod. 17187700**

**Tav 01**





9



8



1

4

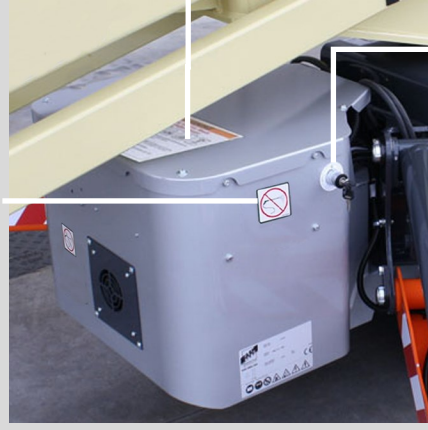

1

1

2

7



3

KIT ADESIVI X17J LITHIUM

SET OF DECALS X17J LITHIUM

KIT COLLANTS X17J LITHIUM

AUFKLEBERSATZ X17J LITHIUM

KIT ADHESIVOS X17J LITHIUM

ADHESIEKIT X17J LITHIUM

**cod. 17187700**

**Tav 01**





9

3

3

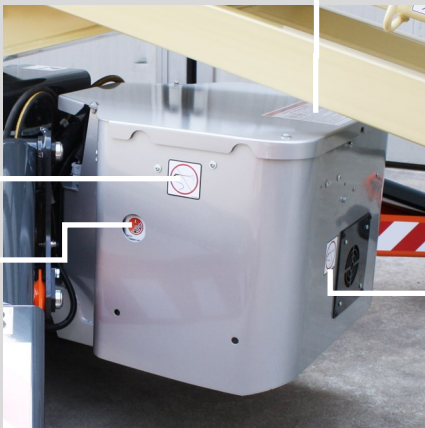

6

1

4



1

1

2

7



8



KIT ADESIVI X19J LITHIUM

SET OF DECALS X19J LITHIUM

KIT COLLANTS X19J LITHIUM

AUFKLEBERSATZ X19J LITHIUM

KIT ADHESIVOS X19J LITHIUM

ADHESIEKIT X19J LITHIUM

**cod. 17187700**

**Tav 01**



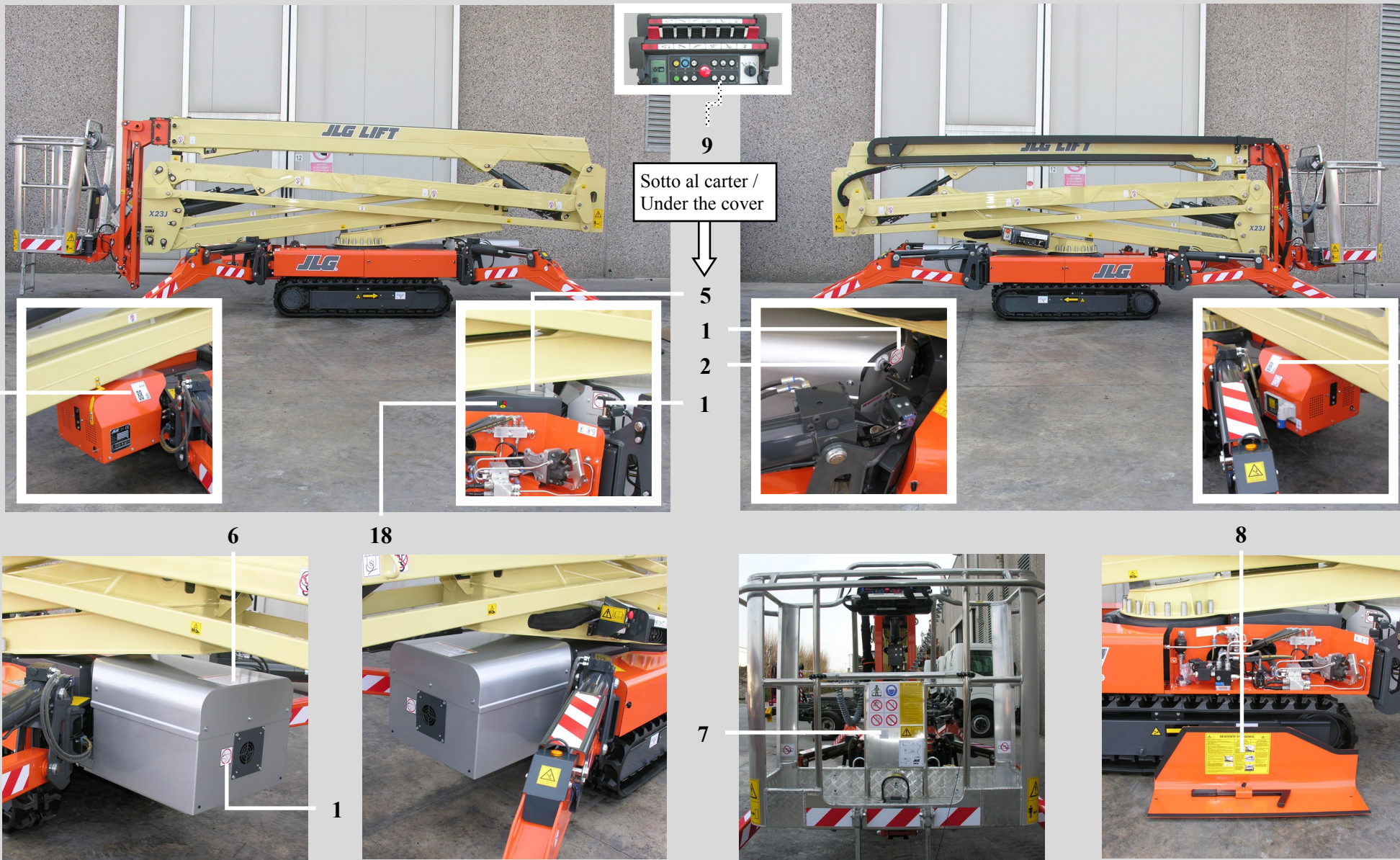

KIT ADESIVI X23J LITHIUM

SET OF DECALS X23J LITHIUM

KIT COLLANTS X23J LITHIUM

AUFKLEBERSATZ X23J LITHIUM

KIT ADHESIVOS X23J LITHIUM

ADHESIEKIT X23J LITHIUM

**cod. 17187700**

**Tav 01**





9



3

3



4

1



1

6

7

1



8

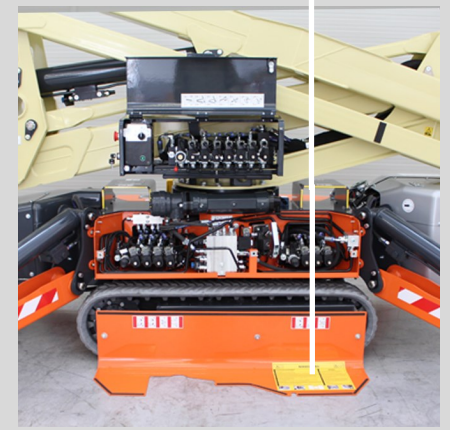

KIT ADESIVI - X13JPLUS LITHIUM  
 SET OF DECALS - X13JPLUS LITHIUM  
 KIT COLLANTS - X13JPLUS LITHIUM

AUFKLEBERSATZ X - X13JPLUS LITHIUM  
 KIT ADHESIVOS - X13JPLUS LITHIUM  
 ADHESIEKIT - X13JPLUS LITHIUM

**cod. 17187700**

**Tav 01**



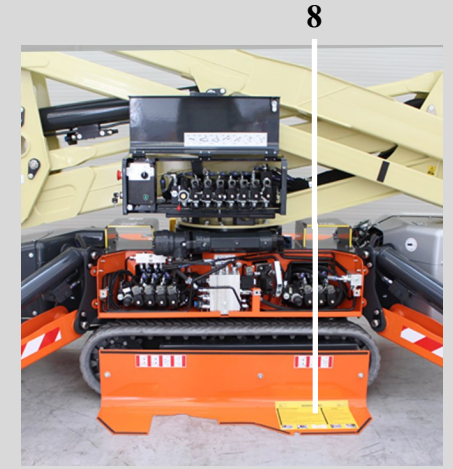

KIT ADESIVI - X15JPLUS LITHIUM

SET OF DECALS - X15JPLUS LITHIUM

KIT COLLANTS - X15JPLUS LITHIUM

AUFKLEBERSATZ X - X15JPLUS LITHIUM

KIT ADHESIVOS - X15JPLUS LITHIUM

ADHESIEKIT - X15JPLUS LITHIUM

**cod. 17187700**

**Tav 01**





9

3

3

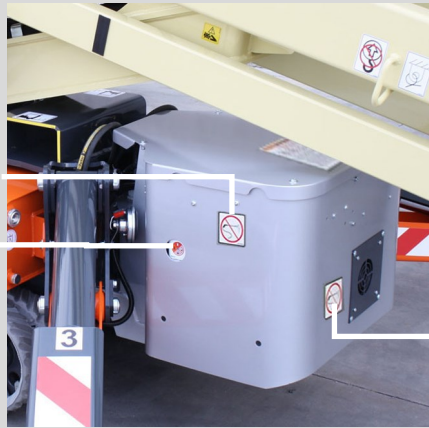

1

4

3



1

6

7

1



8



KIT ADESIVI X17JPLUS LITHIUM

SET OF DECALS X17JPLUS LITHIUM

KIT COLLANTS X17JPLUS LITHIUM

AUFKLEBERSATZ X17JPLUS LITHIUM

KIT ADHESIVOS X17JPLUS LITHIUM

ADHESIEKIT X17JPLUS LITHIUM

**cod. 17187700**

**Tav 01**





9

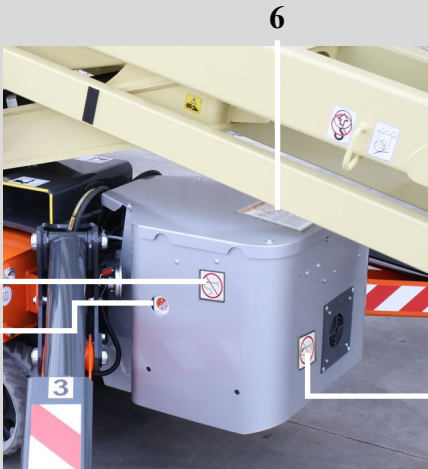

2

1

7



8



KIT ADESIVI X20JPLUS LITHIUM

SET OF DECALS X20JPLUS LITHIUM

KIT COLLANTS X20JPLUS LITHIUM

AUFKLEBERSATZ X20JPLUS LITHIUM

KIT ADHESIVOS X20JPLUS LITHIUM

ADHESIEKIT X20JPLUS LITHIUM

**cod. 17187700**

**Tav 01**



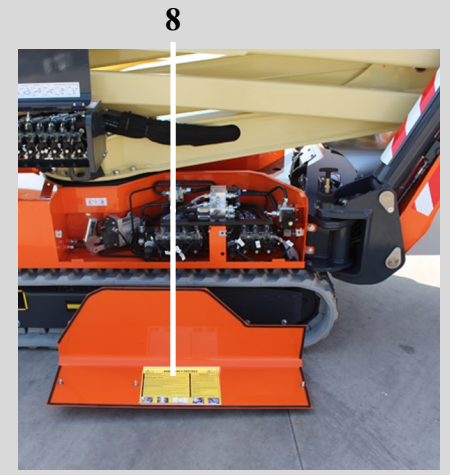
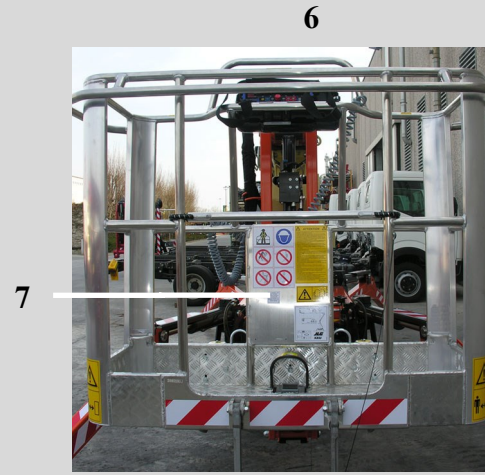
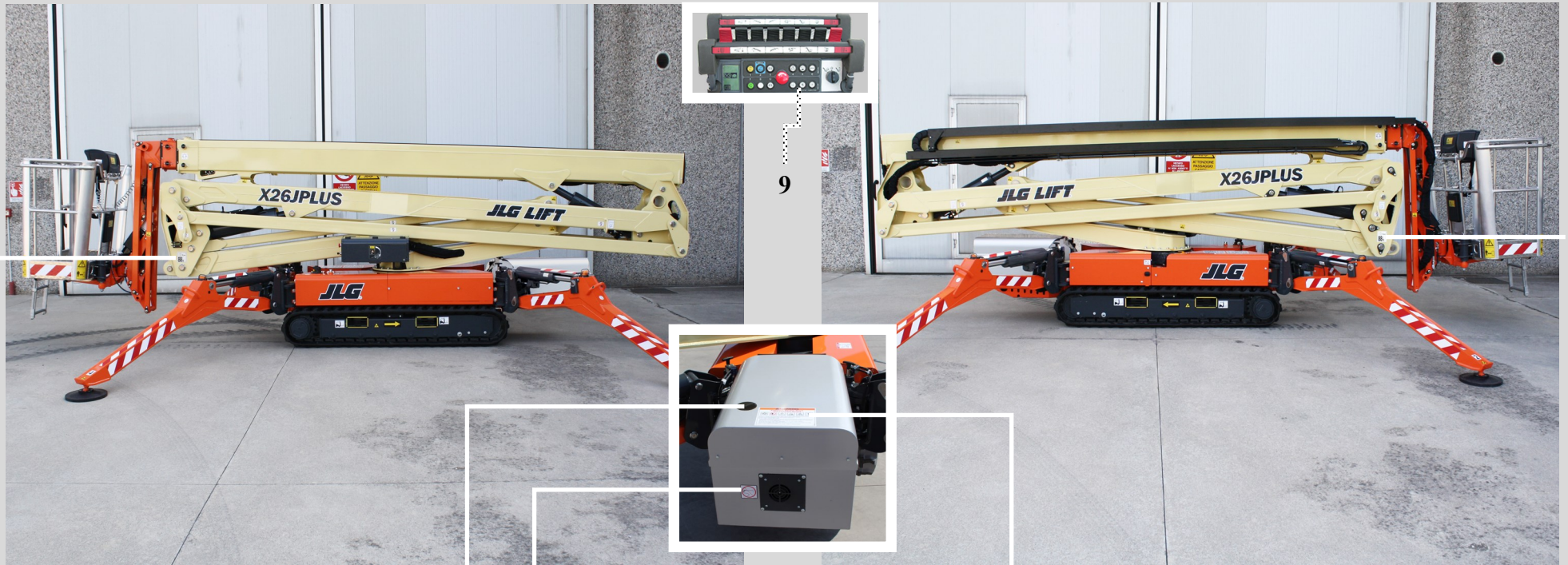

KIT ADESIVI X26JPLUS LITHIUM

SET OF DECALS X26JPLUS LITHIUM

KIT COLLANTS X26JPLUS LITHIUM

AUFKLEBERSATZ X26JPLUS LITHIUM

KIT ADHESIVOS X26JPLUS LITHIUM

ADHESIEKIT X26JPLUS LITHIUM

**cod. 17187700**

**Tav 01**





**KIT LITHIUM SERIE JLG/CE COD. 171877\*\* POSIZIONE ADESIVI IN LINGUA / POSITION LANGUAGE STICKERS**

POS.	COD.	REV.	DESCRIZIONE / DESCRIPTION	Q.tà
	171877IT		KIT ADESIVI INTEGRAZIONE PIATTAFORME AEREE JLG/CE LITHIUM - LINGUA ITALIANO	
06	07188700	A	ADESIVO JLG ATTENZIONE PERICOLO BATTERIE - ITA L=210X145 MM	01
07	07188100	A	ADESIVO JLG RICARICARE LE BATTERIE DOPO L'USO O ALMENO OGNI 3 MESI L=50x50 MM – ITA	01
08 solo X17J	1705720001	A	ADESIVO ISTRUZIONI DISCESA DI EMERGENZA GL14703S LITHIUM ITALIANO L=290X175 MM (**)	01
08			<b>Per le / for X14J-X19J-X23J • X13JP-X15JP-X17JP-X20JP-X26JP</b> <b>Vedere discesa di emergenza motore termico / See emergency lowering heat engine</b>	
	171877GB		KIT ADESIVI INTEGRAZIONE PIATTAFORME AEREE JLG/CE LITHIUM - LINGUA INGLESE	
06	07201700	A	ADESIVO JLG ATTENZIONE PERICOLO BATTERIE - ING L=210X145 MM	01
07	07202100	A	ADESIVO JLG-CE RICARICARE LE BATTERIE DOPO L'USO ALMENO OGNI 3 MESI - ING L=50x50 MM	01
08 per X17J	1705720002	A	ADESIVO ISTRUZIONI DISCESA DI EMERGENZA GL14703S LITHIUM INGLESE L=290X175 MM	01
08			<b>Per le / for X14J-X19J-X23J • X13JP-X15JP-X17JP-X20JP-X26JP</b> <b>Vedere discesa di emergenza motore termico / See emergency lowering heat engine</b>	
	171877FR		KIT ADESIVI INTEGRAZIONE PIATTAFORME AEREE JLG/CE LITHIUM - LINGUA FRANCESE	
06	07201800	A	ADESIVO JLG ADESIVO ATTENZIONE PERICOLO BATTERIE - FRA L=210X145 MM	01
07	07202200	A	ADESIVO JLG RICARICARE LE BATTERIE DOPO L'USO ALMENO OGNI 3 MESI - FRA L=50x50 MM	01
08 per X17J	1705720003	A	ADESIVO ISTRUZIONI DISCESA DI EMERGENZA GL14703S LITHIUM FRANCESE L=290X175 MM (**)	01
08			<b>Per le / for X14J-X19J-X23J • X13JP-X15JP-X17JP-X20JP-X26JP</b> <b>Vedere discesa di emergenza motore termico / See emergency lowering heat engine</b>	

**KIT LITHIUM SERIE JLG/CE COD. 171877\*\* POSIZIONE ADESIVI IN LINGUA / POSITION LANGUAGE STICKERS**

POS.	COD.	REV.	DESCRIZIONE / DESCRIPTION	Q.tà
	171877DE		KIT ADESIVI INTEGRAZIONE PIATTAFORME AEREE JLG/CE LITHIUM - LINGUA TEDESCO	
06	07188800	A	ADESIVO JLG ATTENZIONE PERICOLO BATTERIE - TED L=210X145 MM	01
07	07188200	A	ADESIVO JLG RICARICARE LE BATTERIE DOPO L'USO O ALMENO OGNI 3 MESI L=50x50 MM –TED	01
08 per X17J	1705720004	A	ADESIVO ISTRUZIONI DISCESA DI EMERGENZA GL14703S LITHIUM TEDESCO L=290X175 MM (**)	01
08	<b>Per le / for X14J-X19J-X23J • X13JP-X15JP-X17JP-X20JP-X26JP</b> <b>Vedere discesa di emergenza motore termico / See emergency lowering heat engine</b>			
	171877ES		KIT ADESIVI INTEGRAZIONE PIATTAFORME AEREE JLG/CE LITHIUM - LINGUA SPAGNOLO	
06	07201900	A	ADESIVO JLG ATTENZIONE PERICOLO BATTERIE - SPA L=210X145 MM -	01
07	07202300	A	ADESIVO JLG RICARICARE LE BATTERIE DOPO L'USO ALMENO OGNI 3 MESI - SPA L=50x50 MM	01
08 per X17J	1705720005	A	ADESIVO ISTRUZIONI DISCESA DI EMERGENZA GL14703S LITHIUM SPAGNOLO L=290X175 MM (**)	01
08	<b>Per le / for X14J-X19J-X23J • X13JP-X15JP-X17JP-X20JP-X26JP</b> <b>Vedere discesa di emergenza motore termico / See emergency lowering heat engine</b>			
	171877NL		KIT ADESIVI INTEGRAZIONE PIATTAFORME AEREE JLG/CE LITHIUM - LINGUA OLANDESE	
06	07188900	A	ADESIVO JLG ATTENZIONE PERICOLO BATTERIE - OLA L=210X145 MM	01
07	07188300	A	ADESIVO JLG RICARICARE LE BATTERIE DOPO L'USO O ALMENO OGNI 3 MESI L=50x50 MM – OLA	01
08 per X17J	1705720006	A	ADESIVO ISTRUZIONI DISCESA DI EMERGENZA GL14703S LITHIUM OLANDESE L=290X175 MM (**)	01
08	<b>Per le / for X14J-X19J-X23J • X13JP-X15JP-X17JP-X20JP-X26JP</b> <b>Vedere discesa di emergenza motore termico / See emergency lowering heat engine</b>			

**KIT LITHIUM SERIE JLG/CE COD. 171877\*\* POSIZIONE ADESIVI IN LINGUA / POSITION LANGUAGE STICKERS**

POS.	COD.	REV.	DESCRIZIONE / DESCRIPTION	Q.tà
	171877SW		KIT ADESIVI INTEGRAZIONE PIATTAFORME AEREE JLG/CE LITHIUM - LINGUA SVEDESE	
06	07189000	A	ADESIVO JLG ATTENZIONE PERICOLO BATTERIE - SVE L=210X145 MM	01
07	07188400	A	ADESIVO JLG RICARICARE LE BATTERIE DOPO L'USO O ALMENO OGNI 3 MESI L=50x50 MM – SVE	01
08 per X17J	1705720010	A	ADESIVO ISTRUZ. DISCESA DI EMERGENZA GL14703S LITHIUM SVEDESE L=290X175 MM (**)	01
08	<b>Per le / for X14J-X19J-X23J • X13JP-X15JP-X17JP-X20JP-X26JP</b> <b>Vedere discesa di emergenza motore termico / See emergency lowering heat engine</b>			
	171877PT		KIT ADESIVI INTEGRAZIONE PIATTAFORME AEREE JLG/CE LITHIUM - LINGUA PORTOGHESE	
06	07202000	A	ADESIVO JLG ATTENZIONE PERICOLO BATTERIE - POR L=210X145 MM	01
07	07202400	A	ADESIVO JLG RICARICARE LE BATTERIE DOPO L'USO O ALMENO OGNI 3 MESI L=50x50 MM – POR	01
08 per X17J	1705720007	A	ADESIVO ISTRUZ. DISCESA DI EMERGENZA GL14703S LITHIUM PORTOGHESE L=290X175 MM (**)	01
08	<b>Per le / for X14J-X19J-X23J • X13JP-X15JP-X17JP-X20JP-X26JP</b> <b>Vedere discesa di emergenza motore termico / See emergency lowering heat engine</b>			
	171877DA		KIT ADESIVI INTEGRAZIONE PIATTAFORME AEREE JLG/CE LITHIUM - LINGUA DANESE	
06	07189100	A	ADESIVO JLG ATTENZIONE PERICOLO BATTERIE - DAN L=210X145 MM	01
07	07188500	A	ADESIVO JLG RICARICARE LE BATTERIE DOPO L'USO O ALMENO OGNI 3 MESI L=50x50 MM – DAN	01
08 per X17J	1705720011	A	ADESIVO ISTRUZ. DISCESA DI EMERGENZA GL14703S LITHIUM DANESE L=290X175 MM (**)	01
08	<b>Per le / for X14J-X19J-X23J • X13JP-X15JP-X17JP-X20JP-X26JP</b> <b>Vedere discesa di emergenza motore termico / See emergency lowering heat engine</b>			

**KIT LITHIUM SERIE JLG/CE COD. 171877\*\* POSIZIONE ADESIVI IN LINGUA / POSITION LANGUAGE STICKERS**

POS.	COD.	REV.	DESCRIZIONE / DESCRIPTION	Q.tà
	171877NO		KIT ADESIVI INTEGRAZIONE PIATTAFORME AEREE JLG/CE LITHIUM - LINGUA NORVEGESE	
06	07189200	A	ADESIVO JLG ATTENZIONE PERICOLO BATTERIE - NOR L=210X145 MM	01
07	07188600	A	ADESIVO JLG RICARICARE LE BATTERIE DOPO L'USO O ALMENO OGNI 3 MESI L=50x50 MM – NOR	01
08 per X17J	1705720012	A	ADESIVO ISTRUZ. DISCESA DI EMERGENZA GL14703S LITHIUM NORVEGESE L=290X175 MM (**)	01
08			<b>Per le / for X14J - X17JPLUS - X19J - X20JPLUS - X23J - X26JPLUS</b> <b>Vedere discesa di emergenza motore termico / See emergency lowering heat engine</b>	
	171877RU		KIT ADESIVI INTEGRAZIONE PIATTAFORME AEREE JLG/CE LITHIUM - LINGUA RUSSO	
06	07920800	A	ADESIVO JLG ATTENZIONE PERICOLO BATTERIE - RUSSO L=210X145 MM	01
07	07910300	A	ADESIVO JLG RICARICARE LE BATTERIE DOPO L'USO O ALMENO OGNI 3 MESI L=50x50 MM – RUS	01
08 per X17J	/		/	/
08			<b>Per le / for X14J - X17JPLUS - X19J - X20JPLUS - X23J - X26JPLUS</b> <b>Vedere discesa di emergenza motore termico / See emergency lowering heat engine</b>	
	171877PL		KIT ADESIVI INTEGRAZIONE PIATTAFORME AEREE JLG/CE LITHIUM - LINGUA POLACCO	
06	07508000	A	ADESIVO JLG-ANSI ATTENZIONE PERICOLO BATTERIE - POLACCO L=210X145 MM	01
07	07508100	A	ADESIVO JLG-CE RICARICARE LE BATTERIE DOPO L'USO - POLACCO L=50x50 MM	01
08 per X17J	/		/	/
08			<b>Per le / for X14J - X17JPLUS - X19J - X20JPLUS - X23J - X26JPLUS</b> <b>Vedere discesa di emergenza motore termico / See emergency lowering heat engine</b>	

**KIT LITHIUM SERIE JLG/CE COD. 171877\*\* POSIZIONE ADESIVI IN LINGUA / POSITION LANGUAGE STICKERS**

POS.	COD.	REV.	DESCRIZIONE / DESCRIPTION	Q.tà
	171877SL		KIT ADESIVI INTEGRAZIONE PIATTAFORME AEREE JLG/CE LITHIUM - LINGUA SLOVENO	
06	07920900	A	ADESIVO JLG / CE ATTENZIONE PERICOLO BATTERIE - SLOVENO L=210X145 MM	01
07	07910500	A	ADESIVO JLG RICARICARE LE BATTERIE DOPO L'USO O ALMENO OGNI 3 MESI L=50x50 MM – SLO	01
08 per X17J	/	/	/	/
08	<b>Per le / for X14J - X17JPLUS - X19J - X20JPLUS - X23J - X26JPLUS</b> <b>Vedere discesa di emergenza motore termico / See emergency lowering heat engine</b>			
	171877FI		KIT ADESIVI INTEGRAZIONE PIATTAFORME AEREE JLG/CE LITHIUM - LINGUA FINLANDESE	
06	07921000	A	ADESIVO JLG / CE ATTENZIONE PERICOLO BATTERIE - FINLANDESE L=210X145 MM	01
07	07910600	A	ADESIVO JLG RICAR. LE BATTERIE DOPO L'USO O ALMENO OGNI 3 MESI L=50x50 MM – FINLANDE	01
08 per X17J	/	/	/	/
08	<b>Per le / for X14J - X17JPLUS - X19J - X20JPLUS - X23J - X26JPLUS</b> <b>Vedere discesa di emergenza motore termico / See emergency lowering heat engine</b>			
	171877CE		KIT ADESIVI INTEGRAZIONE PIATTAFORME AEREE JLG/CE LITHIUM - LINGUA CECO	
06	07921100	A	ADESIVO JLG-CE ATTENZIONE PERICOLO BATTERIE - CECO L=210X145 MM	01
07	07910700	A	ADESIVO JLG-CE RICARICARE LE BATTERIE DOPO L'USO ALMENO OGNI 3 MESI - JAPAN L=50x50 MM	01
08 per X17J	/	/	/	/
08	<b>Per le / for X14J - X17JPLUS - X19J - X20JPLUS - X23J - X26JPLUS</b> <b>Vedere discesa di emergenza motore termico / See emergency lowering heat engine</b>			
	171877JA		KIT ADESIVI INTEGRAZIONE PIATTAFORME AEREE JLG/CE LITHIUM - LINGUA GIAPPONESE	
06	07341100	A	ADESIVO JLG - CE ATTENZIONE PERICOLO BATTERIE - JAPAN L=210X145 MM	01
07	07341200	A	ADESIVO JLG-CE RICARICARE LE BATTERIE DOPO L'USO - JAPAN L=50x50 MM	01
08 per X17J	/	/	/	/
08	<b>Per le / for X14J - X17JPLUS - X19J - X20JPLUS - X23J - X26JPLUS</b> <b>Vedere discesa di emergenza motore termico / See emergency lowering heat engine</b>			





**AGGIORNATO IL / UPDATED 23/10/2020**

**KIT ADESIVI SICUREZZA PIATTAFORMA AEREA /**  
*AERIAL PLATFORM KIT STICKERS SAFETY*  
**JLG/CE - X26JPLUS**

**Cod. 17633400**

**+ codici kit in lingua / + kit codes in language**

**176334IT / 176334GB / 176334FR / 176334DE / 176334ES / 176334NL /**  
**176334SW / 176334PT / 176334DA / 176334NO / 176334RU /**  
**176334PL / 176334SL / 176334FI / 176334CE / 176334JA / 176334RO**

*DA USARE CON / FOR USE WITH*

**17633500 KIT ADESIVI COMMERCIALI PIATTAFORMA AEREA JLG/CE X26JPLUS**  
*STICKER KITS COMMERCIAL AERIAL PLATFORM*

**17187700 KIT INTEGRAZIONE ADESIVI PER PIATTAFORME AEREE JLG/CE LITHIUM /**  
*INTEGRATION KIT STICKERS PLATFORMS JLG / CE LITHIUM*



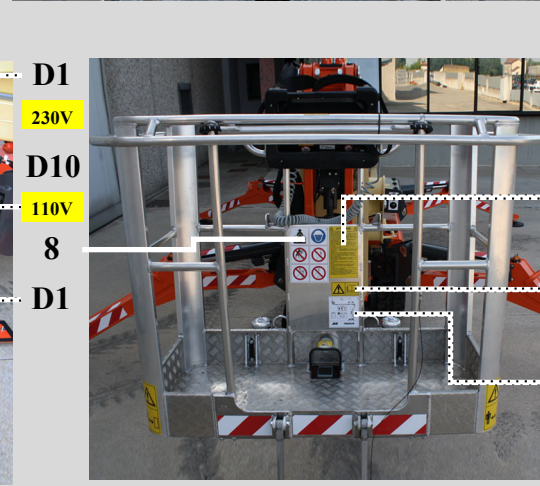
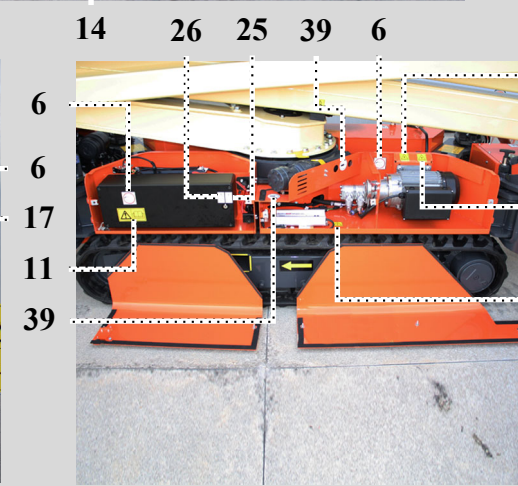
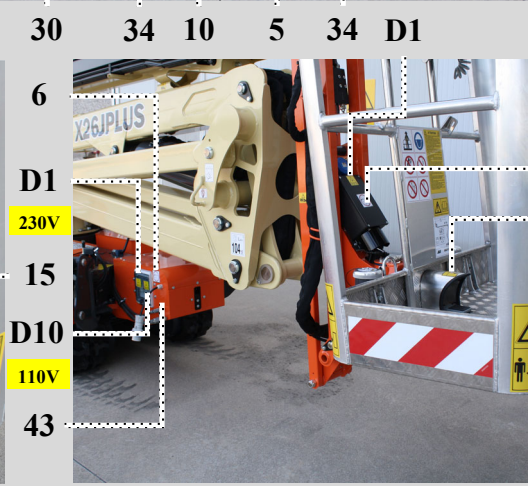
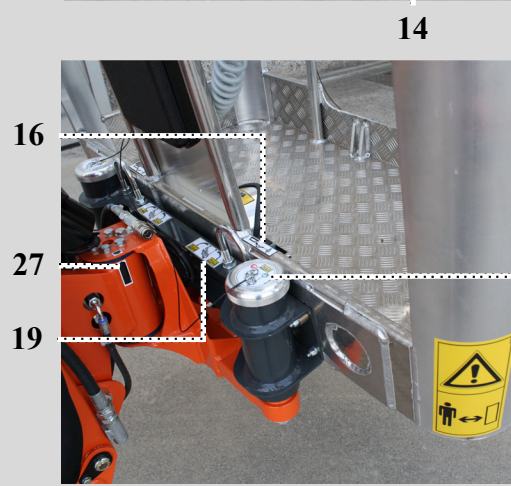
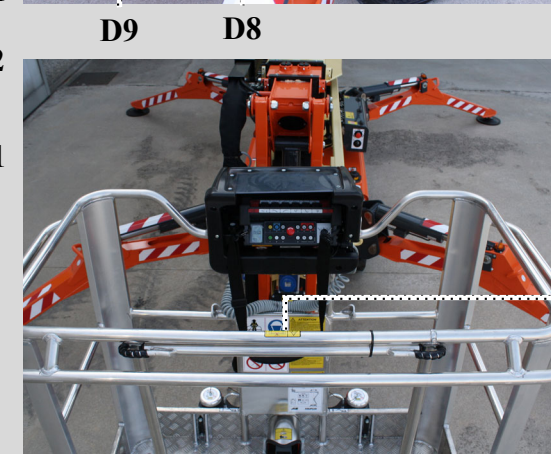
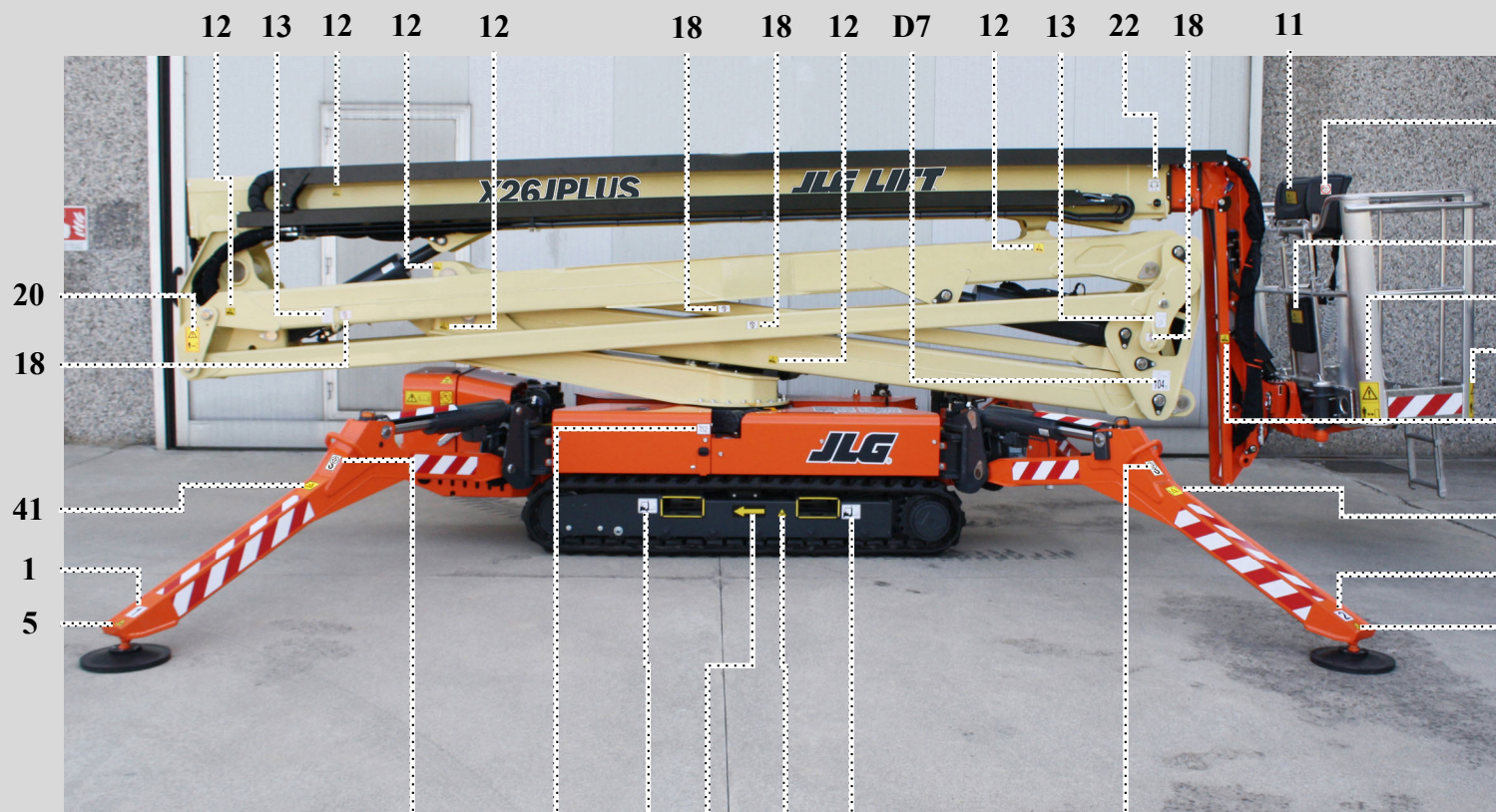

KIT ADESIVI - JLG/CE - X26JPLUS  
 SET OF DECALS - JLG/CE - X26JPLUS  
 KIT COLLANTS - JLG/CE - X26JPLUS

AUFKLEBERSATZ - JLG/CE - X26JPLUS  
 KIT ADHESIVOS - JLG/CE - X26JPLUS  
 ADHESIEKIT - JLG/CE - X26JPLUS

**cod. 17633400**

Ed. 23/10/2020 | Tav 01



13 22 18 12 D7 18 18 12 12 18 13 12



6  
21  
21  
12  
41  
4  
5

20  
41  
3  
5



D5 40



7  
33

14 34 5 10 34 14 38

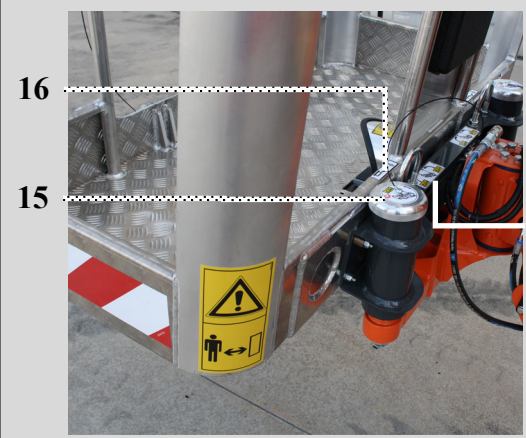

16  
15

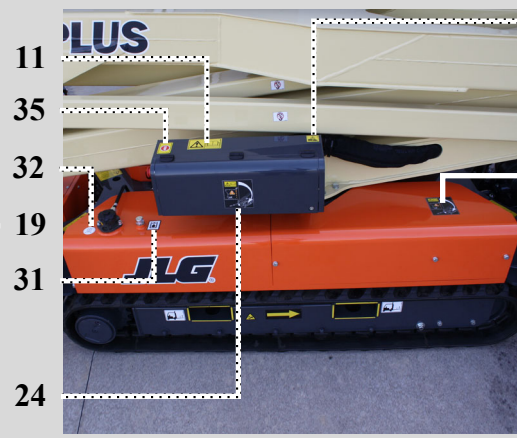

11  
35  
32  
19  
31  
24

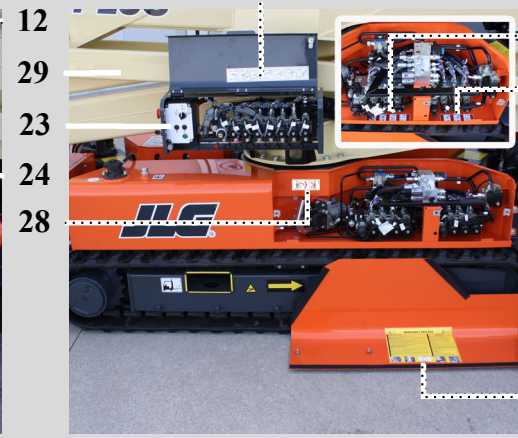

12  
29  
23  
24  
28

36  
37  
L2

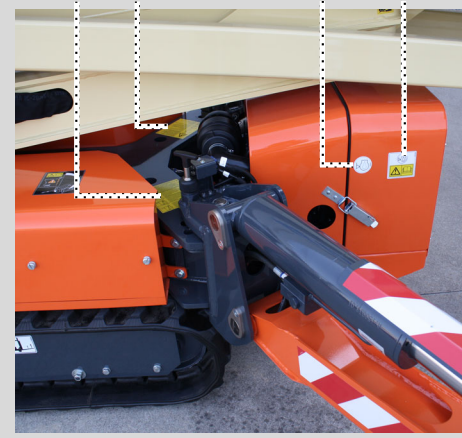

29 29 D3 D4

KIT ADESIVI - JLG/CE - X26JPLUS

SET OF DECALS - JLG/CE - X26JPLUS

KIT COLLANTS - JLG/CE - X26JPLUS

AUFKLEBERSATZ - JLG/CE - X26JPLUS

KIT ADHESIVOS - JLG/CE - X26JPLUS

ADHESIEKIT - JLG/CE - X26JPLUS

**cod. 17633400**

Ed. 23/10/2020

Tav 02



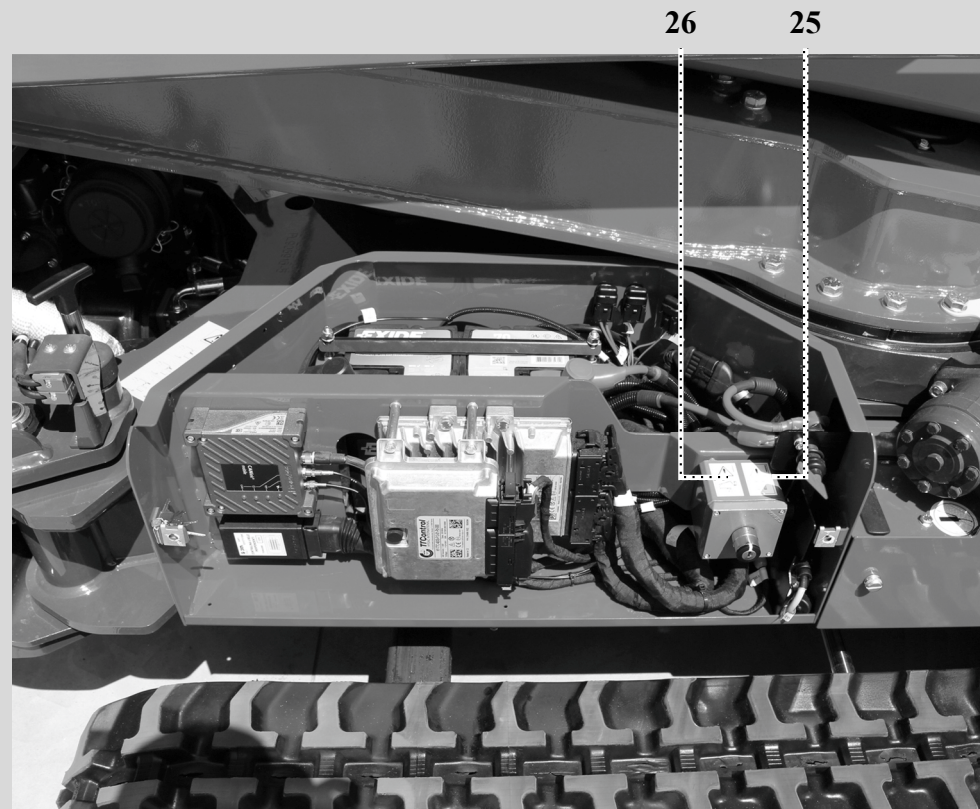

6

D1

D1

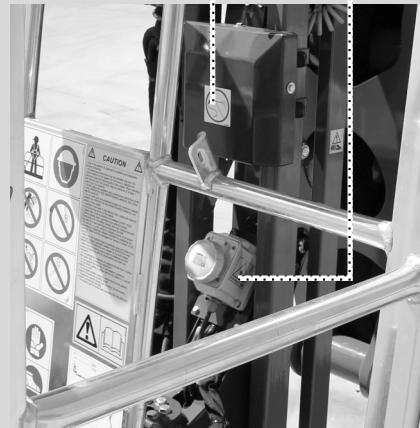

KIT ADESIVI - JLG/CE - X26JPLUS/200

AUFKLEBERSATZ - JLG/CE - X26JPLUS/200

SET OF DECALS - JLG/CE - X26JPLUS/200

KIT ADHESIVOS - JLG/CE - X26JPLUS/200

KIT COLLANTS - JLG/CE - X26JPLUS/200

ADHESIEKIT - JLG/CE - X26JPLUS/200

**cod. 17633400**

**Ed. 23/10/2020**

**Tav 03**

**JLG/CE - X26JPLUS COD. 17633400 POSIZIONE ADESIVI IN DISTINTA MACCHINA /**  
*ADHESIVE POSITION IN THE DISTINCT OF THE MACHINE*

POS.	COD.	REV.	ADESIVI IN DISITINTA / STICKERS IN LIST	Q.tà
D1	06561200	<b>B</b>	ADESIVO PERICOLO 230 VOLT 16A GIALLO 47X47 MM <b>_MOD_B</b>	05
	06042400	<b>B</b>	ADESIVO PERICOLO 110 VOLT 16A GIALLO <b>_MOD_B</b>	05
D2	06214200	A	ADESIVO LIQUIDO REFRIGERANTE SFONDO BIANCO Ø 50 MM	01
D3	06060000	A	ADESIVO LIVELLO OLIO MOTORE Ø50 MM	01
D4	06227200	<b>B</b>	ADESIVO CONTROLLARE LIVELLO OLIO MOTORE L=80X80 MM <b>_MOD_B</b>	<b>01</b>
D5	1701505	A	ADESIVO JLG CARBURANTE DIESEL L= 50,8X63,5 MM (**)	01
D6	06164600	A	ADESIVO FILTRO ARIA Ø50 SFONDO BIANCO	01
D7	07034200	<b>B</b>	ADESIVO RUMORE 104 dB L=90X100 MM <b>_MOD_B</b>	02
D8	1706098	<b>B</b>	ADESIVO JLG PERICOLO ESPLOSIONE L=63,5X117,475 MM <b>_MOD_B</b> (**)	01
D9	06056300	A	ADESIVO PERICOLO SCOTTATURE TRIANGOLARE SFONDO GIALLO L=60X51 MM	02
D10	07668000	A	ADESIVO PERICOLO 110 VOLT 32A GIALLO L=47 X 47 MM	02
D11				
D12				
D13				
D14				
D15				
D16				
D17				
D18				
D19				
D20				
D21				
D22				
D23				
D24				

**JLG/CE - X26JPLUS COD. 17633400 POSIZIONE ADESIVI / POSITION ADHESIVE**

**JLG**

POS.	COD.	REV.	DESCRIZIONE / DESCRIPTION	Q.tà
01	06555500	A	ADESIVO NR 1 L=50X60 MM BIANCO	01
02	06555600	A	ADESIVO NR 2 L=50X60 MM BIANCO	01
03	06555700	A	ADESIVO NR 3 L=50X60 MM BIANCO	01
04	06555800	A	ADESIVO NR 4 L=50X60 MM BIANCO	01
05	06041200	A	ADESIVO SCHIACCIAMENTO PIEDI TRIANGOLARE - GIALLO L=53X46 MM	06
06	1001125483	A	ADESIVO JLG VIETATO LAVARE L=63,5X63,5 MM	06
07	07668200	B	ADESIVO EMERGENCY STOP E BLOCCHETTO ACCENSIONE L=85x160 MM <b>_MOD_B</b>	01
08	07878400	A	ADESIVO CASCO IMBRAGATURA E DIVIETI LL1370 L=175X118 MM	01
09	1706493	B	ADESIVO JLG SCORRIMENTO SBARRA CHIUSURA CESTO L= 76,2X25,4 MM <b>_MOD_B</b>	01
10	06040500	A	ADESIVO DIREZ. TRASLAZIONE FRECCIA GIALLA SFONDO NERO L=61 X 160 MM	02
11	06040900	A	ADESIVO LEGGERE IL MANUALE GIALLO L=125 X 65 MM	06
12	06041300	B	ADESIVO ATTENZIONE PERICOLO TAGLI L=35 X 40 MM GIALLO <b>_MOD_B</b>	13
13	1703814	A	ADESIVO JLG ATTACCO ANCORAGGIO L=55,56X76,2 MM	04
14	07071200	A	ADESIVO JLG PUNTO DI SOLLEVAMENTO L= 40X66 MM	04
15	06448200	B	ADESIVO "SBLOCCARE SOLO NEI CASI PREVISTI" Ø 60 MM <b>_MOD_B</b>	02
16	1704277	A	ADESIVO JLG ATTACCO CINTURE DI SICUREZZA L= 76,2X19,05 MM	02
17	1705828	B	ADESIVO JLG INTERUTTORE PEDALE L= 69,85X54 <b>_MOD_B</b>	01
18	07056700	A	ADESIVO JLG DIVIETO DI SOLLEVAMENTO L=54,88X40 MM	08
19	06448100	B	ADESIVO RIPRISTINARE I TAPPI FERMO GUIDA L= 100X35 MM <b>_MOD_B</b>	02
20	07058800	A	ADESIVO PERICOLO MANTENERE LE DISTANZE L=65X130 MM	02
21	06040300	A	ADESIVO PERICOLO MANTENERE LE DISTANZE GIALLO L=100 X 200 MM (**)	04
22	06704400	B	ADESIVO REGOLAZIONE PATTINI SFILO BIANCO <b>_MOD_B</b> (**)	02
23	07668300	A	ADESIVO SELETTORE SCATOLA TERRA / CESTO L=105X155 MM	01
24	07056800	B	ADESIVO JLG DISCESA DI EMERGENZA ALL'INTERNO L=114X130 MM <b>_MOD_B</b>	03

**JLG/CE - X26JPLUS COD. 17633400 POSIZIONE ADESIVI / POSITION ADHESIVE**

**JLG**

POS.	COD.	REV.	DESCRIZIONE / DESCRIPTION	Q.tà
25	06086000	A	ADESIVO SISTEMA BYPASS TRASLAZIONE L=30X50 MM	01
26	06085900	A	ADESIVO SISTEMA BYPASS PARTE AEREA L=30X50MM	01
27	06706500	A	ADESIVO ALLINEAMENTO CESTO (2 PEZZI) L=16X50 MM	01
28	06998800	A	ADESIVO DEVIATORE POMPA MANUALE PIATTAFORMA GL17.80XL L=86X34 MM	01
29	06713600	<b>B</b>	ADESIVO CONTROLLO MICRON STABILIZZATORI GIALLO <b>_MOD_B</b>	04
30	1702155	A	ADESIVO JLG STACCABATTERIA L= 63,5X50,80 MM	01
31	1701504	A	ADESIVO JLG OLIO IDRAULICO L=50,8x63,5 MM	01
32	06164700	A	ADESIVO FILTRO OLIO SFONDO BIANCO Ø50 MM	01
33	06165000	A	ADESIVO LIVELLO OLIO IDRAULICO SFONDO BIANCO Ø50 MM	01
34	07350300	A	ADESIVO SOLLEVAMENTO PIATTAFORMA CON MULETTO L=90X70 MM	04
35	06254800	<b>B</b>	ADESIVO STOP EMERGENZA SFONDO GIALLO L=70X50 MM <b>_MOD_B</b>	01
36	1608710001	<b>C</b>	ADESIVO PULSANTI DISTRIBUTORE A TERRA LATO SX GL17.80 L=194X50 MM <b>_MOD_C</b>	01
37	1608710002	<b>C</b>	ADESIVO PULSANTI DISTRIBUTORE A TERRA LATO DX GL17.80 L=150X50 MM <b>_MOD_C</b>	01
38	07668100	A	ADESIVO PULSANTI DISTRIBUTORE PARTE AEREA LIGHT LIFT 2614 L=318X52 MM -	01
39	06136900	A	ADESIVO PUNTI DI INGRASSAGGIO Ø 55 mm	02
40	07240300	<b>B</b>	ADESIVO DISTANZA 1 METRO SU TELE/RADIO COMANDI L= 75x35 MM <b>_MOD_B</b>	01
41	07668400	A	ADESIVO REAZIONE AL SUOLO STABILIZZATORI LIGHT LIFT 2614 L=45x48 MM	04
42	07667000	A	ADESIVO JLG PORTATA CESTO 2 PERS. X26JPLUS L=135X145 MM	01
43	1704125	<b>A</b>	ADESIVO JLG ATTACCO ARIA E ACQUA	01
44				
45				
			<b>PER MACCHINE CON CESTO A 1 PERSONA / FOR MACHINE WITH BASKET 1 PERSON</b>	
42	07676200	A	ADESIVO PORTATA CESTO 1 PERSONA X26JPLUS L=135X145 MM ( non in distinta )	01

**JLG/CE - X26JPLUS COD. 176334\*\* POSIZIONE ADESIVI IN LINGUA / POSITION LANGUAGE STICKERS**

POS.	COD.	REV.	DESCRIZIONE / DESCRIPTION	Q.tà
	176334IT		ADESIVI SICUREZZA PIATTAFORMA AEREA X26JPLUS - LINGUA ITALIANO	
L1	06555300	<b>C</b>	ADESIVO USO PIATTAFORMA AEREA CINGOLATA - ITALIANO L=128X230 <b>_MOD_C</b>	01
L2	076685IT	<b>B</b>	ADESIVO DISCESA DI EMERG LL2614 MOTORE TERMICO E LITHIUM - ITALIANO - L=290X205 MM <b>_MOD_B</b>	01
	176334GB		ADESIVI SICUREZZA PIATTAFORMA AEREA X26JPLUS - LINGUA INGLESE	
L1	06562600	<b>C</b>	ADESIVO USO PIATTAFORMA AEREA CINGOLATA - INGLESE L=128X230 <b>_MOD_C</b>	01
L2	076685GB	<b>B</b>	ADESIVO DISCESA DI EMERGENZA LL2614 MOTORE TERMICO E LITHIUM - INGLESE L=290X205 MM <b>_MOD_B</b>	01
	176334FR		ADESIVI SICUREZZA PIATTAFORMA AEREA X26JPLUS - LINGUA FRANCESE	
L1	06562700	<b>C</b>	ADESIVO USO PIATTAFORMA AEREA CINGOLATA - FRANCESE L=128X230 <b>_MOD_C</b>	01
L2	076685FR	<b>B</b>	ADESIVO DISCESA DI EMERGENZA LL2614 MOTORE TERMICO E LITHIUM - FRANCESE L=290X205 MM <b>_MOD_B</b>	01
	176334DE		ADESIVI SICUREZZA PIATTAFORMA AEREA X26JPLUS - LINGUA TEDESCO	
L1	06562800	<b>C</b>	ADESIVO USO PIATTAFORMA AEREA CINGOLATA - TEDESCO L=128X230 <b>_MOD_C</b>	01
L2	076685DE	<b>B</b>	ADESIVO DISCESA DI EMERGENZA LL2614 MOTORE TERMICO E LITHIUM - TEDESCO L=290X205 MM <b>_MOD_B</b>	01
	176334ES		ADESIVI SICUREZZA PIATTAFORMA AEREA X26JPLUS - LINGUA SPAGNOLO	
L1	06562900	<b>C</b>	ADESIVO USO PIATTAFORMA AEREA CINGOLATA - SPAGNOLO L=128X230 <b>_MOD_C</b>	01
L2	076685ES	<b>C</b>	ADESIVO DISCESA DI EMERGENZA LL2614 MOTORE TERMICO E LITHIUM - SPAGNOLO L=290X205 MM <b>_MOD_C</b>	01
	176334NL		ADESIVI SICUREZZA PIATTAFORMA AEREA X26JPLUS - LINGUA OLANDESE	
L1	06563000	<b>C</b>	ADESIVO USO PIATTAFORMA AEREA CINGOLATA - OLANDESE L=128X230 <b>_MOD_C</b>	01
L2	076685NL	<b>B</b>	ADESIVO DISCESA DI EMERGENZA LL2614 MOTORE TERMICO E LITHIUM - OLANDESE L=290X205 MM <b>_MOD_B</b>	01



**JLG/CE - X26JPLUS COD. 176334\*\* POSIZIONE ADESIVI IN LINGUA / POSITION LANGUAGE STICKERS**

POS.	COD.	REV.	DESCRIZIONE / DESCRIPTION	Q.tà
	176334SW		ADESIVI SICUREZZA PIATTAFORMA AEREA X26JPLUS - LINGUA SVEDESE	
L1	07137300	<b>C</b>	ADESIVO USO PIATTAFORMA AEREA CINGOLATA - SVEDESE L= 128X230 MM <b>_MOD_C</b>	01
L2	076685SW	<b>B</b>	ADESIVO DISCESA DI EMERGENZA LL2614MOTORE TERMICO E LITHIUM - SVEDESE L=290X205 MM <b>_MOD_B</b>	01
	176334PT		ADESIVI SICUREZZA PIATTAFORMA AEREA X26JPLUS - LINGUA PORTOGHESE	
L1	06563100	<b>C</b>	ADESIVO USO PIATTAFORMA AEREA CINGOLATA - PORTOGHESE L=128X230 <b>_MOD_C</b>	01
L2	076685PT	<b>B</b>	ADESIVO DISCESA DI EMERG. LL2614 MOTORE TERMICO E LITHIUM - PORTOGHESE L=290X205 MM <b>_MOD_B</b>	01
	176334DA		ADESIVI SICUREZZA PIATTAFORMA AEREA X26JPLUS - LINGUA DANESE	
L1	07138100	<b>C</b>	ADESIVO USO PIATTAFORMA AEREA CINGOLATA - DANESE L= 128X230 MM <b>_MOD_C</b>	01
L2	076685DA	<b>B</b>	ADESIVO DISCESA DI EMERGENZA LL2614 MOTORE TERMICO E LITHIUM - DANESE L=290X205 MM <b>_MOD_B</b>	01
	176334NO		ADESIVI SICUREZZA PIATTAFORMA AEREA X26JPLUS - LINGUA NORVEGESE	
L1	07162000	<b>C</b>	ADESIVO USO PIATTAFORMA AEREA CINGOLATA - NORVEGESE L=128X230 MM <b>_MOD_C</b>	01
L2	076685NO	<b>B</b>	ADESIVO DISCESA DI EMERGENZA LL2614 MOTORE TERMICO E LITHIUM - NORVEGESE L=290X205 MM <b>_MOD_B</b>	01
	176334RU		ADESIVI SICUREZZA PIATTAFORMA AEREA X26JPLUS - LINGUA RUSSO	
L1	07514800	A	ADESIVO USO PIATTAFORMA AEREA CINGOLATA - RUSSO L=128X230 MM	01
L2	076685RU	<b>B</b>	ADESIVO DISCESA DI EMERG LL2614 MOTORE TERMICO E LITHIUM - RUSSO - L=290X205 MM <b>_MOD_B</b>	01
	176334PL		ADESIVI SICUREZZA PIATTAFORMA AEREA X26JPLUS - LINGUA POLACCO	
L1	07506600	<b>B</b>	ADESIVO USO PIATTAFORMA AEREA CINGOLATA - POLACCO L= 128X230MM <b>_MOD_B</b>	01
L2	076685PL	<b>B</b>	ADESIVO DISCESA DI EMERG LL2614 MOTORE TERMICO E LITHIUM - POLACCO - L=290X205 MM <b>_MOD_B</b>	01





**AGGIORNATO IL / UPDATED 31/08/2015**

**KIT ADESIVI COMMERCIALI PIATTAFORMA AEREA /**  
*AERIAL PLATFORM KIT STICKERS COMMERCIAL*  
**JLG/CE - X26JPLUS**

**Cod. 17633500**

*DA USARE CON / FOR USE WITH*  
**17633400 KIT ADESIVI DI SICUREZZA PIATTAFORMA AEREA JLG/CE X26JPLUS /**  
*STICKER KITS SAFETY AERIAL PLATFORM X26JPLUS*





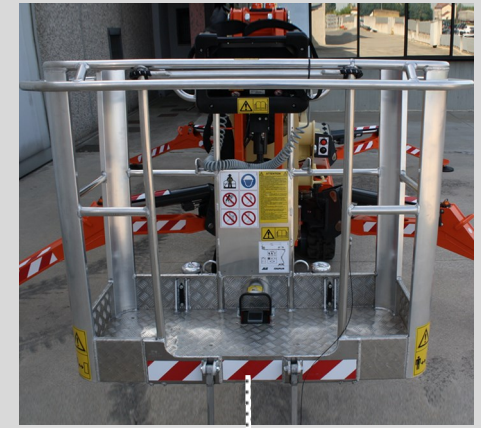
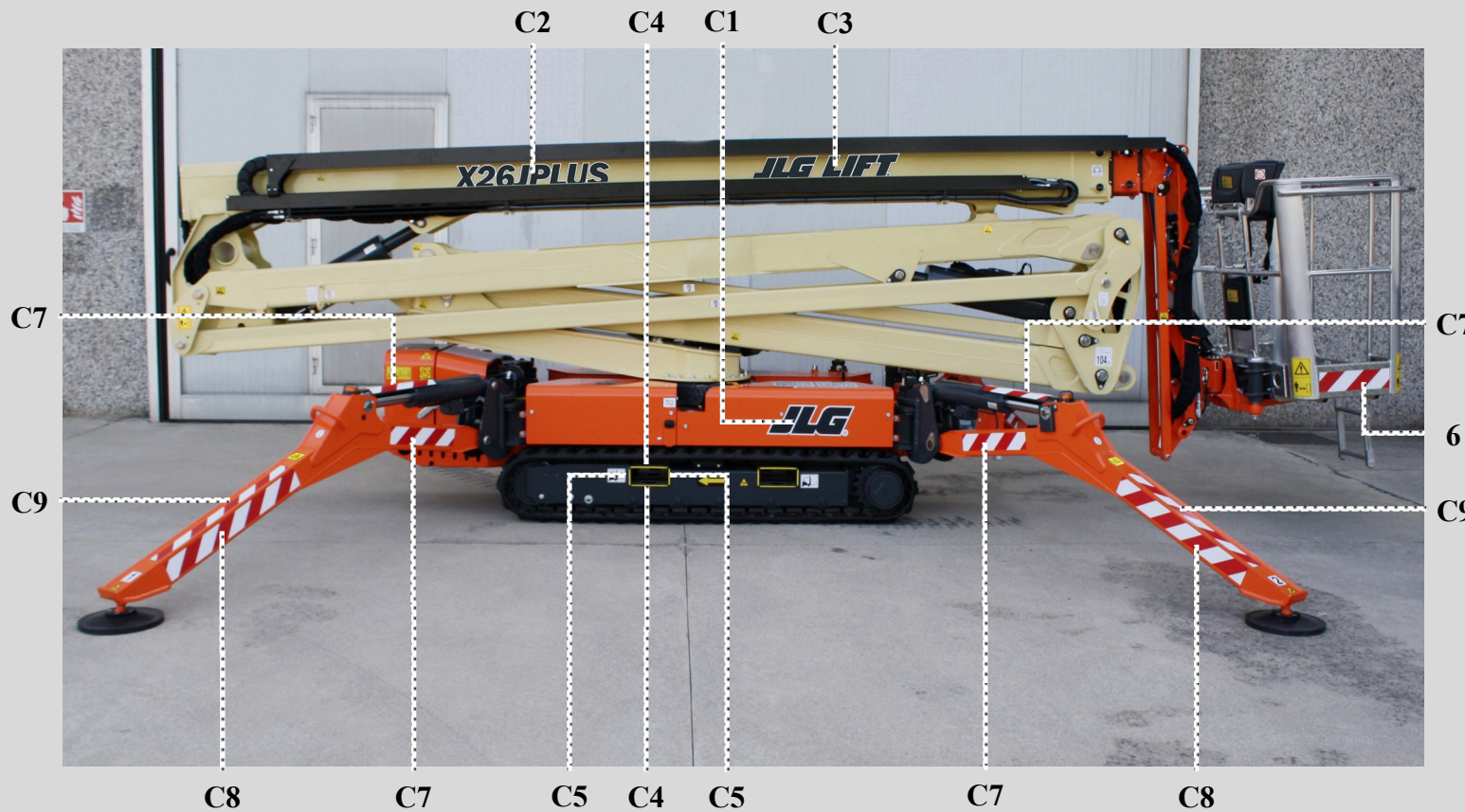

KIT ADESIVI - JLG/CE - X26JPLUS

SET OF DECALS - JLG/CE - X26JPLUS

KIT COLLANTS - JLG/CE - X26JPLUS

AUFKLEBERSATZ - JLG/CE - X26JPLUS

KIT ADHESIVOS - JLG/CE - X26JPLUS

ADHESIEKIT - JLG/CE - X26JPLUS

**cod. 17633500**

Ed. 31/08/2015

Tav 01



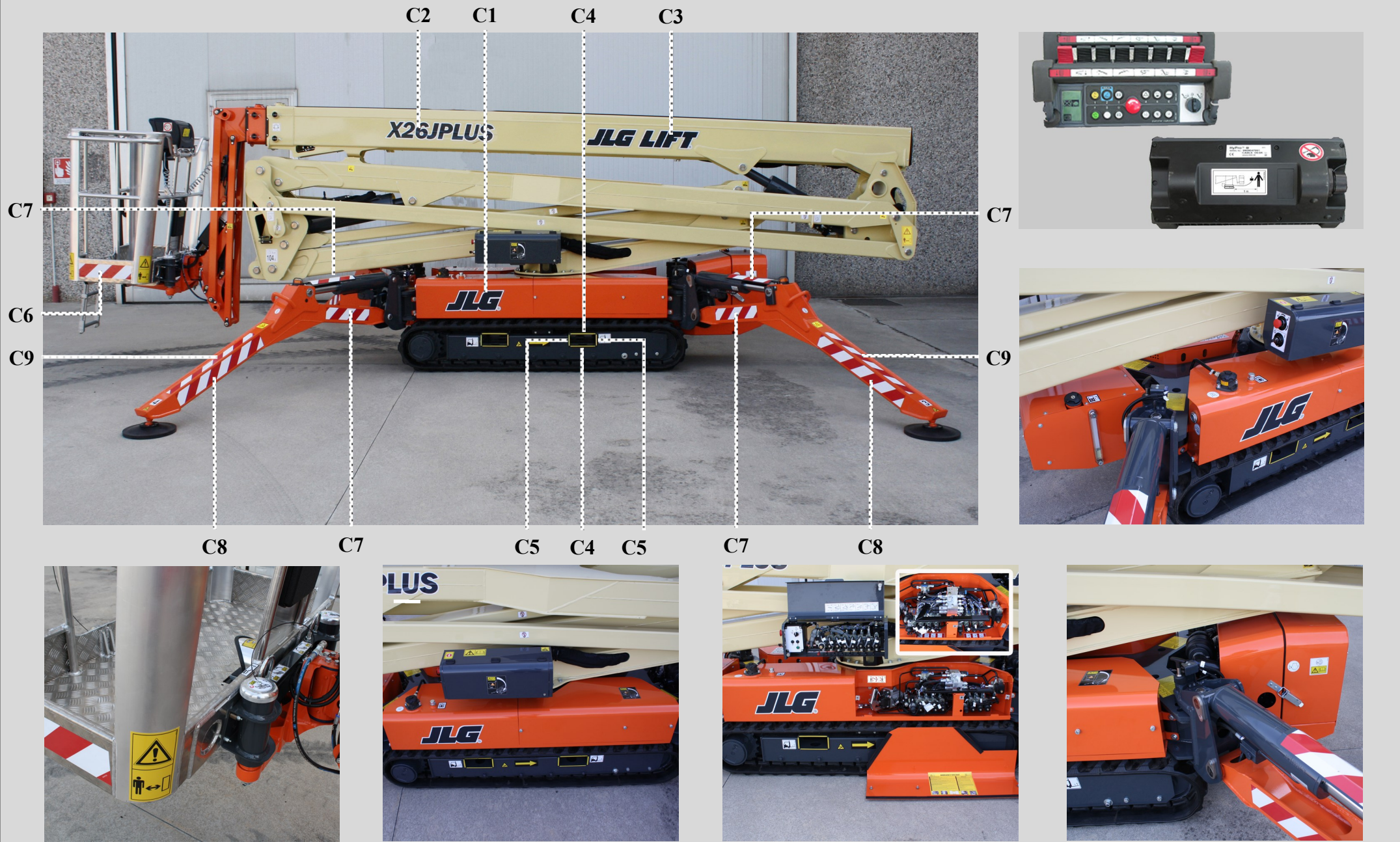

	KIT ADESIVI - JLG/CE - X26JPLUS	AUFKLEBERSATZ - JLG/CE - X26JPLUS	<b>cod. 17633500</b>	
	SET OF DECALS - JLG/CE - X26JPLUS	KIT ADHESIVOS - JLG/CE - X26JPLUS		
	KIT COLLANTS - JLG/CE - X26JPLUS	ADHESIEKIT - JLG/CE - X26JPLUS	Ed. 31/08/2015	Tav 02

**KIT ADESIVI COMMERCIALI PIATTAFORMA AEREA /**  
*AERIAL PLATFORM KIT STICKERS COMMERCIAL*  
**JLG/CE - X26JPLUS**

**Cod. 17633500**

**COD. 17633500 POSIZIONE ADESIVI / POSITION STICKERS JLG / CE - X26JPLUS**

**Aggiornato il / Updated 31/08/2015**

**JLG**

POS.	COD.	REV.	DESCRIZIONE / DESCRIPTION	Q.tà
C1	07060500	A	ADESIVO JLG LOGO JLG COLORE GRIGIO PANTONE 432C L=432x150MM	02
C2	07633800	A	ADESIVO JLG LOGO X26JPLUS COLORE GRIGIO PANTONE 432C L= 827X136 MM	02
C3	07677500	A	ADESIVO JLG LOGO JLG LIFT COLORE GRIGIO PANTONE 432C L=848X136 MM	02
C4	07268400	A	ADESIVO ATTENZIONE SOLLEVAMENTO FORCHE L=180X7 MM	08
C5	07268300	A	ADESIVO ATTENZIONE SOLLEVAMENTO FORCHE L=80X7 MM	08
C6	06086700	A	ADESIVO CON RIGHE BIANCHE E ROSSE L=430X100 MM	02
C7	06039900	A	ADESIVO CON RIGHE BIANCHE ROSSE L= 420 X 80 MM	12
C8	06039700	A	ADESIVO CON RIGHE BIANCHE ROSSE L= 700 X 80 MM	09
C9	06039600	A	ADESIVO CON RIGHE BIANCHE ROSSE L= 700 X 50	04
C10				
C11				
C12				
C13				
C14				
C15				
C16				
C17				
C18				
C19				
C20				
C21				
C22				
C23				

**AGGIORNATO IL / UPDATED 03/12/2019**

**KIT ADESIVI SICUREZZA PIATTAFORMA AEREA /**  
*AERIAL PLATFORM KIT STICKERS SAFETY*  
**JLG/ANSI - X770AJ**

**Cod. 17633600**

**+ kit in lingua non inclusi nel codice generale /**  
*+kit in language that is not included in the general*

**176336GB - 176336FR - 176336ES - 176336PT**

**DA USARE CON / FOR USE WITH:**

**17633700 KIT ADESIVI COMMERCIALI PIATTAFORMA AEREA JLG/ANSI - X770AJ**  
*STICKERS KIT COMMERCIAL AERIAL PLATFORM*

**17107300 KIT ADESIVI INTEGRAZIONE PER PIATTAFORME JLG-ANSI LITIUM /**  
*STICKER KIT FOR INTEGRATION LITIUM PLATFORM*  
**X390AJ\_X500AJ\_X550AJ\_X600AJ\_X700AJ\_X770AJ**





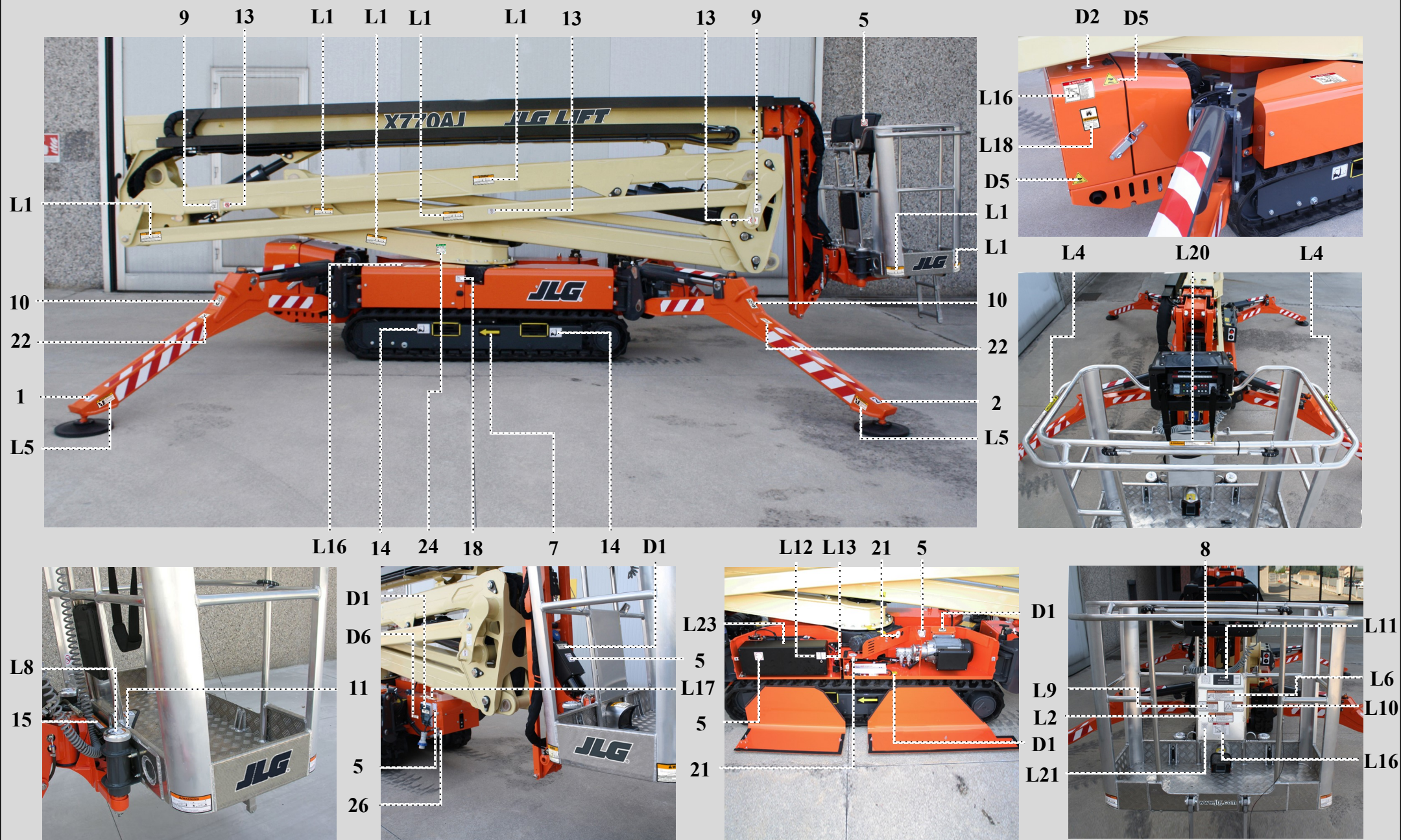

KIT ADESIVI - JLG/ANSI - X770AJ

SET OF DECALS - JLG/ANSI - X770AJ

KIT COLLANTS - JLG/ANSI - X770AJ

AUFKLEBERSATZ - JLG/ANSI - X770AJ

KIT ADHESIVOS - JLG/ANSI - X770AJ

ADHESIEKIT - JLG/ANSI - X770AJ

**Cod. 17633600**

Ed. 03/12/2019

Tav 01



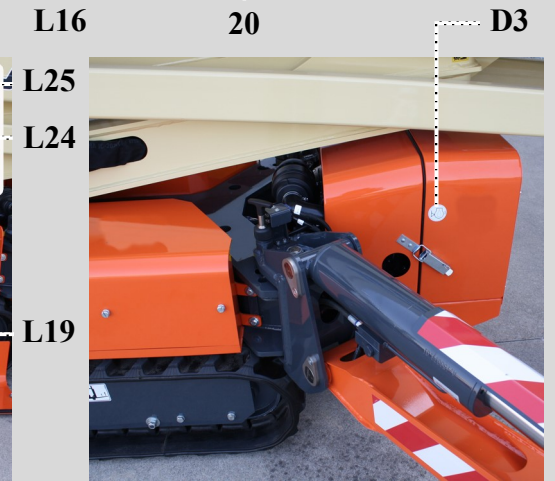
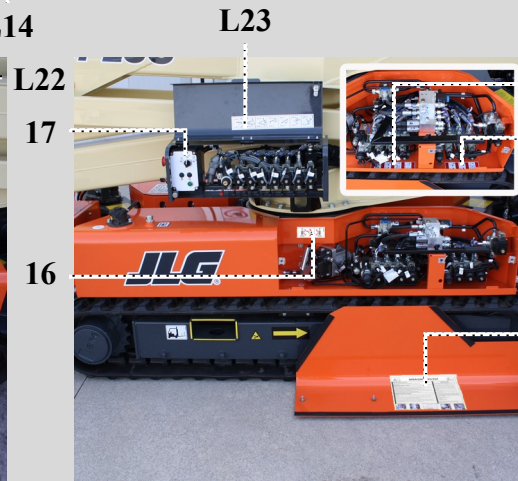
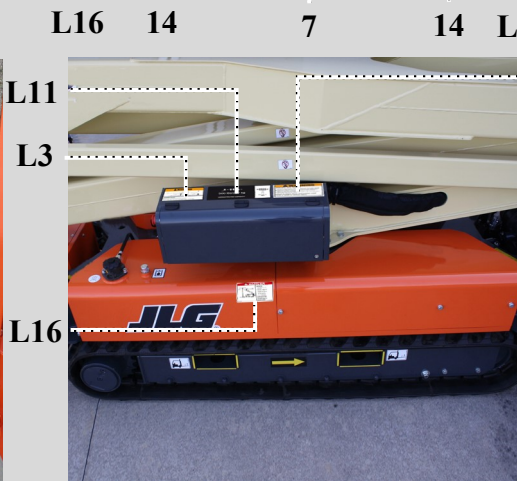
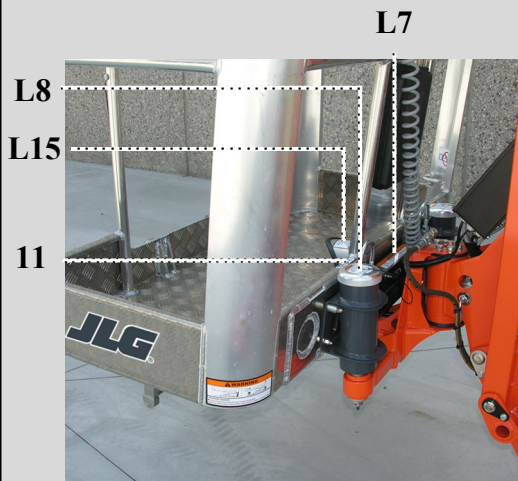
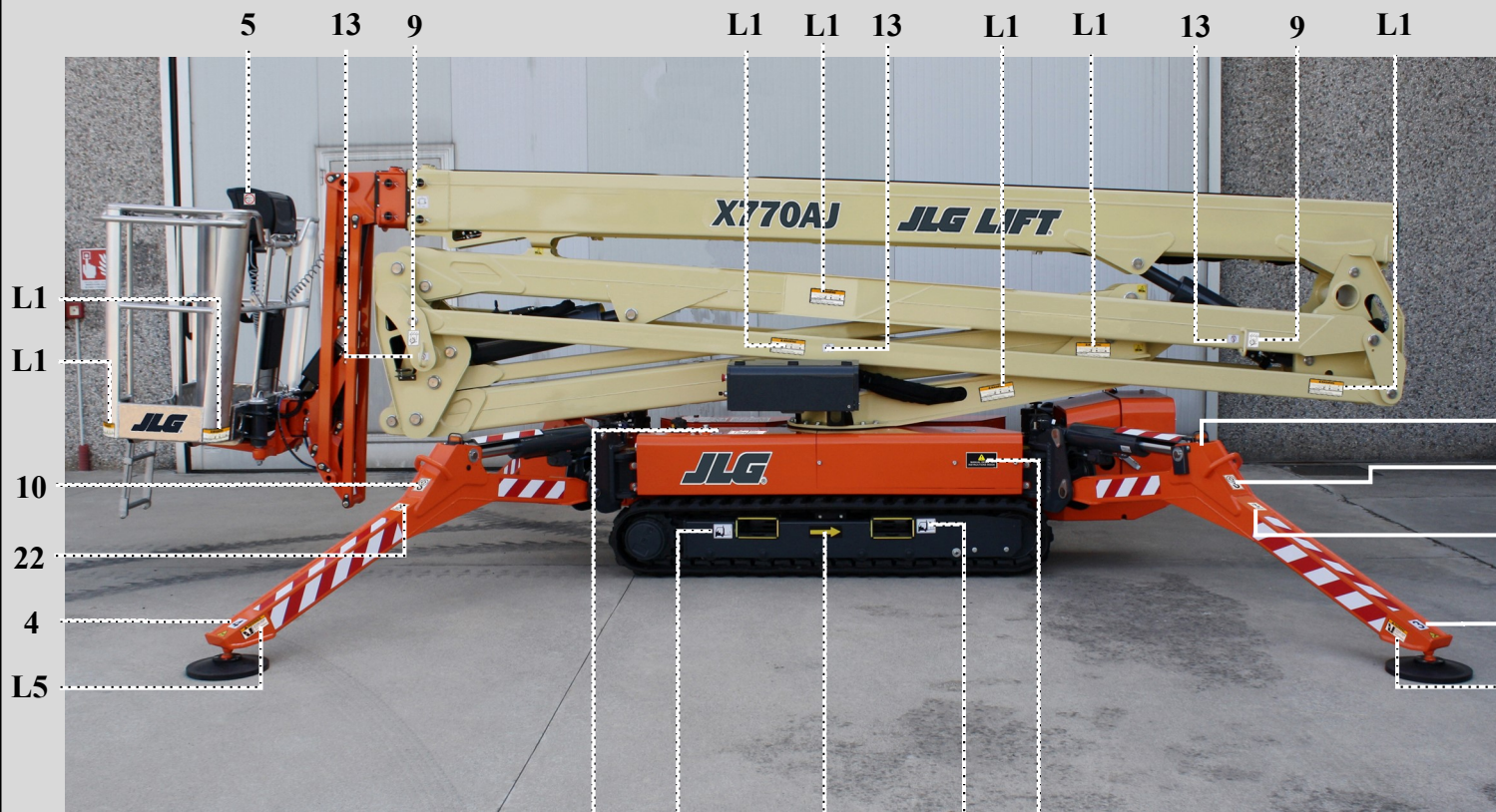

KIT ADESIVI - JLG/ANSI - X770AJ

SET OF DECALS - JLG/ANSI - X770AJ

KIT COLLANTS - JLG/ANSI - X770AJ

AUFKLEBERSATZ - JLG/ANSI - X770AJ

KIT ADHESIVOS - JLG/ANSI - X770AJ

ADHESIEKIT - JLG/ANSI - X770AJ

**Cod. 17633600**

Ed. 03/12/2019

Tav 02



L12 L13

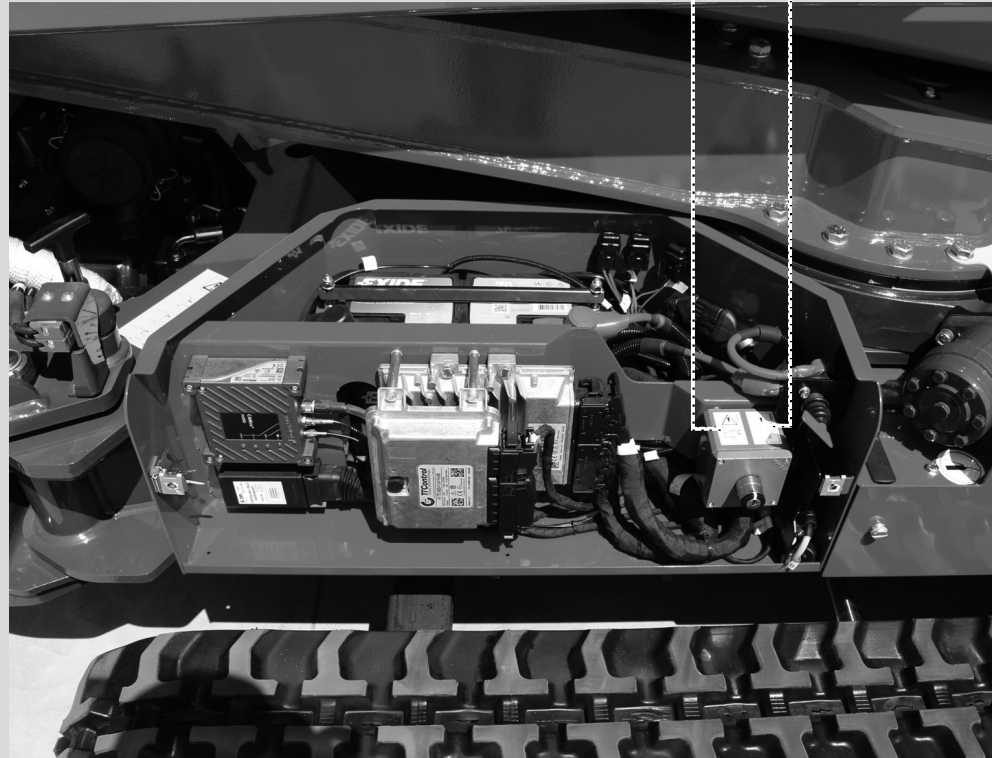

D1

5

D1



KIT ADESIVI - JLG/ANSI - X770AJ/200

SET OF DECALS - JLG/ANSI - X770AJ/200

KIT COLLANTS - JLG/ANSI - X770AJ/200

AUFKLEBERSATZ - JLG/ANSI - X770AJ/200

KIT ADHESIVOS - JLG/ANSI - X770AJ/200

ADHESIEKIT - JLG/ANSI - X770AJ/200

**Cod. 17633600**

**Ed. 03/12/2019**

**Tav 03**

**JLG/ANSI X770AJ • COD. 17633600 POSIZIONE ADESIVI IN DISTINTA MACCHINA / ADHESIVE POSITION AT DISTINCT MACHINE**

POSIZIONE	CODICE	REV.	ADESIVI IN DISTINTA MACCHINA / STICKERS IN LIST MACHINE	QUANTITA'
D1	07056300	A	ADESIVO JLG PERICOLO 220V - 50/60HZ L= 75X18,75 MM	05
	07056400	B	ADESIVO JLG PERICOLO 120V - 60HZ L= 75x32.68 MM <b>MOD_B</b>	05
D2	06214200	A	ADESIVO LIQUIDO REFRIGERANTE SFONDO BIANCO Ø 50 MM (**)	01
D3	06060000	A	ADESIVO LIVELLO OLIO MOTORE Ø50mm	01
D4	1701505	A	ADESIVO JLG CARBURANTE DIESEL L= 50,8X63,5	01
D5	06056300	A	ADESIVO PERICOLO SCOTTATURE L=60X51 TRIANGOLARE SFONDO GIALLO	02
D6	1001228370	A	ADESIVO JLG NORMATIVA CANADESE ICES-001	01
	1001223453	A	ADESIVO JLG NORMATIVA CANADESE ICES-002	
D8				
D9				
D10				
D11				
D12				
D13				
D14				
D15				
D16				
D17				
D18				
D19				
D20				
D21				
D22				
D23				
D24				
D25				



JLG/ANSI X770AJ • COD. 17633600 POSIZIONE ADESIVI / POSITION STICKERS

JLG

POSIZIONE	CODICE	REV.	DESCRIZIONE	QUANTITA'
01	06555500	A	ADESIVO NR 1 L=50X60 BIANCO	01
02	06555600	A	ADESIVO NR 2 L=50X60 BIANCO	01
03	06555700	A	ADESIVO N° 3 L=50X60 BIANCO	01
04	06555800	A	ADESIVO N° 4 L=50X60 BIANCO	01
05	1001125483	A	ADESIVO JLG VIETATO LAVARE L=63,5X63,5 MM	06
06	07668200	B	ADESIVO EMERGENCY STOP E BLOCCHETTO ACCENSIONE L=85x160 MM <b>MOD_B</b>	01
07	06040500	A	ADESIVO DIREZ. TRASLAZIONE FRECCIA GIALLA SFONDO NERO L=61 X 160	02
08	1701640	A	ADESIVO JLG LEGGERE IL MANUALE L= 69,85x69,85 MM	01
09	1703814	A	ADESIVO JLG ATTACCO ANCORAGGIO L=55,56X76,2 MM	04
10	07071200	A	ADESIVO JLG PUNTO DI SOLLEVAMENTO L= 40X66 MM	04
11	1704277	A	ADESIVO JLG ATTACCO CINTURE DI SICUREZZA L= 76,2X19,05 MM	02
12	06164700	A	ADESIVO FILTRO OLIO IDRAULICO Ø50 MM BIANCO	01
13	07056700	A	ADESIVO JLG DIVIETO DI SOLLEVAMENTO L=40X54,88	06
14	07350300	A	ADESIVO SOLLEVAMENTO PIATTAFORMA CON MULETTO L=90X70 MM	04
15	06706500	A	ADESIVO ALLINEAMENTO CESTO (2 PEZZI) L=16X50+13	01
16	06998800	A	ADESIVO DEVIATORE POMPA MANUALE PIATTAFORMA GL17.80XL L=86X34	01
17	07668300	A	ADESIVO SELETTORE SCATOLA TERRA / CESTO L=105X155 MM	01
18	1702155	A	ADESIVO JLG STACCABATTERIA L= 63,5X50,80 MM	01
19	1701504	A	ADESIVO JLG OLIO IDRAULICO L=50,8x63,5 MM	01
20	06165000	A	ADESIVO LIVELLO OLIO IDRAULICO Ø50 SFONDO BIANCO	01
21	06136900	A	ADESIVO PUNTI DI INGRASSAGGIO Ø 55 mm	02
22	07678300	A	ADESIVO REAZIONE AL SUOLO STABILIZZATORI X770AJ COLORE BIANCO L= 50X50 MM	04
23	07240300	B	ADESIVO DISTANZA 1m SU TELE/RADIO COMANDI <b>MOD_B</b>	01
24	1001223055	A	ADESIVO JLG INSPEZIONE ANNUALE RICHIESTA	01
25	/	/	/	/
26	1704125	A	ADESIVO JLG ATTACCO ARIA E ACQUA	01
27				

**JLG/ANSI X7700AJ - COD. 176336\*\* ADESIVI IN LINGUA / ADHESIVES IN LANGUAGE**

**JLG**

POS.	CODICE				DESCRIZIONE	Q.TA'
	176336FR	176336PT	176336ES	176336GB		
					KIT ADESIVI SICUREZZA PIATTAFORMA AEREA JLG / ANSI X770AJ - LINGUA INGLESE	
L1	07116800	07121400		07056100	ADESIVO JLG PERICOLO SCHIACCIAMENTO - ING L= 140x60,71 MM	14
L2	07119100	07123700		1706387	ADESIVO JLG PERICOLO SCHIACCIAMENTO - ING L=177,80x69,85 MM ( SUL CESTO )	01
L3	07118500	07123100		1706099	ADESIVO JLG PERICOLO SCHIACCIAMENTO - ING L= 161,925X69, 85 MM ( A TERRA )	01
L4	07117800	07122400		1702868_B	ADESIVO JLG PERICOLO SCHIACCIAMENTO MANO - ING L= 241, 30X25.40 MM <b>MOD_B</b>	02
L5	07116900	07121500		07056200	ADESIVO JLG ATTACCO SCHIACCIAM. ARTO INFERIORE - ING L= 110x60 MM ( PRES. STABILIZZ.)	08
L6	07119000	07123600		1706386	ADESIVO JLG PERICOLO CADUTE - ING L=196,85x76,2 MM	01
L7	07116700	07121300		07051100_B	ADESIVO JLG PERICOLO CADUTA - RIPRISTINARE I TAPPI - ING L= 196,5x35 MM <b>MOD_B</b>	01
L8	07116600	07121200		07051000	ADESIVO JLG ATTENZ.CADUTE - SBLOCCARE SOLO NEI CASI PREVISTI - ING D Ø 60 FORO 4 MM (**)	02
L9	07118700	07123300		1706133_C	ADESIVO JLG PERICOLO RIBALTAMENTO - ING L=139,7X68,85 MM <b>MOD_C</b>	01
L10	07117300	07121900		07058700	ADESIVO JLG POSIZIONE STABILIZZATORI X700 - ING L=139,7X68, 85 MM	01
L11	081081FR	081081PT		081081GB	ADESIVO JLG/ ANSI CARICO MAX IN CESTA X1000AJ - L=196,85x76,2 MM	02
L12	07115200	07119800		07042100	ADESIVO JLG SISTEMA BYPASS PARTE AEREA - ING L=30X50 (**)	01
L13	07115300	07119900		07042200	ADESIVO JLG SISTEMA BYPASS TRASLAZIONE - ING L= 30X50 (** )	01
L14	07117900	07122500		1702901	ADESIVO JLG ISTRUZIONI DISCESA EMERGENZA / POMPA MANUALE - ING L=114,3x58,73MM	01
L15	07119200	07123800		3252347_B	ADESIVO JLG ATTENZIONE PEDALE - ING L= 69,85x57,15 MM <b>MOD_B</b>	01
L16	07118600	07123200		1706128_E	ADESIVO JLG PERICOLO FOLGORAZIONE - ING L=120,65x91,50 MM <b>MOD_E</b>	05
L17	07118200	07122800		1703813	ADESIVO JLG PERICOLO ESPLOSIONE BATTERIE - ING L=149, 25X47,62 MM	01
L18	07118300	07122900		1704972_C	ADESIVO JLG PERICOLO ESPLOSIONE - ING L=63,5x92,07 MM <b>MOD_C</b>	01
L19	076791FR_B	076791PT_B		076791GB_B	ADESIVO JLG DISCESA DI EMERG. X770AJ MOTORE TERMICO E LITHIUM - ING L=290X205 MM <b>B</b>	01
L20	07118900	07123500		1706385_C	ADESIVO JLG SCORRIMENTO SBARRA CHIUSURA CESTO - ING L= 184,15X25,4 MM <b>MOD_C</b>	01
L21	08069800	08069800		08069800	ADESIVO JLG ATTENZIONE PROP.65 L=101,6X57,1 MM RIF JLG CODE. 1001231801C	01
L22	07118800	07123400		1706135_B	ADESIVO JLG USO PIATTAFORMA - ING L=139,70x88,90 MM <b>MOD_B</b>	01
L23	076787FR	076787PT		076787GB	ADESIVO JLG ANSI PULSANTI DISTRIBUTORE PARTE AEREA X770AJ - ING L=318X52 MM	01
L24	072425FR	072425PT		072425GB	ADESIVO JLG ANSI PULSANTI DISTRIBUTORI A TERRA LATO SX X500AJ - ING L=194X50 MM	01
L25	072426FR	072426PT		072426GB	ADESIVO JLG ANSI PULSANTI DISTRIBUTORI A TERRA LATO DX X500AJ - ING L=150X50 MM	01

ADESIVI COMMERCIALI PIATTAFORMA AEREA  
AERIAL PLATFORM COMMERCIAL DECALS

**X770AJ**

**17633700**

# HISTORY REVISION

DATA/DATE	VERSION	MODIFICHE/CHANGES	AUTORE
24/07/2015	1.0	Versione di partenza Starting version	Renso Maurizio
31/08/2015	1.1	Aggiunto N. 01 code. 07633900 + 07677500 Add N. 01 code 07633900 + 07677500	Renso Maurizio
27/11/2019	1.2	Aggiunto N. 02 code. 06039700 Add N. 02 code 06039700	Masaggia Mattia
23/04/2021	2.0	Nuovo layout senza foto New layout without photos	Masaggia Mattia

**LISTA ADESIVI**  
**DECALS LIST**

<b>CODE</b>	<b>DESCRIZIONE/DESCRIPTION</b>	<b>QTY</b>
07060500	ADESIVO JLG LOGO JLG COLORE GRIGIO PANTONE 432C L=432x150MM	02
07633900	ADESIVO JLG LOGO X770AJ COLORE GRIGIO PANTONE 432C L=623X136 MM	02
07677500	ADESIVO JLG LOGO JLG LIFT COLORE GRIGIO PANTONE 432C L=848X136 MM	02
07690100	ADESIVO JLG - LOGO JLG PER CESTO COLORE GRIGIO PANTONE 432C L=300x104,2 MM	02
07691500	ADESIVO LOGO WWW.JLG.COM COLORE PANTONE 432C L=200X33 MM	01
06039900	ADESIVO CON RIGHE BIANCHE E ROSSE L= 420 X 80 MM	12
06039700	ADESIVO CON RIGHE BIANCHE ROSSE L= 700X80 MM	10
06039600	ADESIVO CON RIGHE BIANCHE ROSSE L= 700X50 MM	04
07268300	ADESIVO ATTENZIONE SOLLEVAMENTO FORCHE L=80X7 MM	08
07268400	ADESIVO ATTENZIONE SOLLEVAMENTO FORCHE L=180X7 MM	08
08294800	ADESIVO BI-ENERGY VERSIONE JLG (A=54.92mm L=500mm)	02



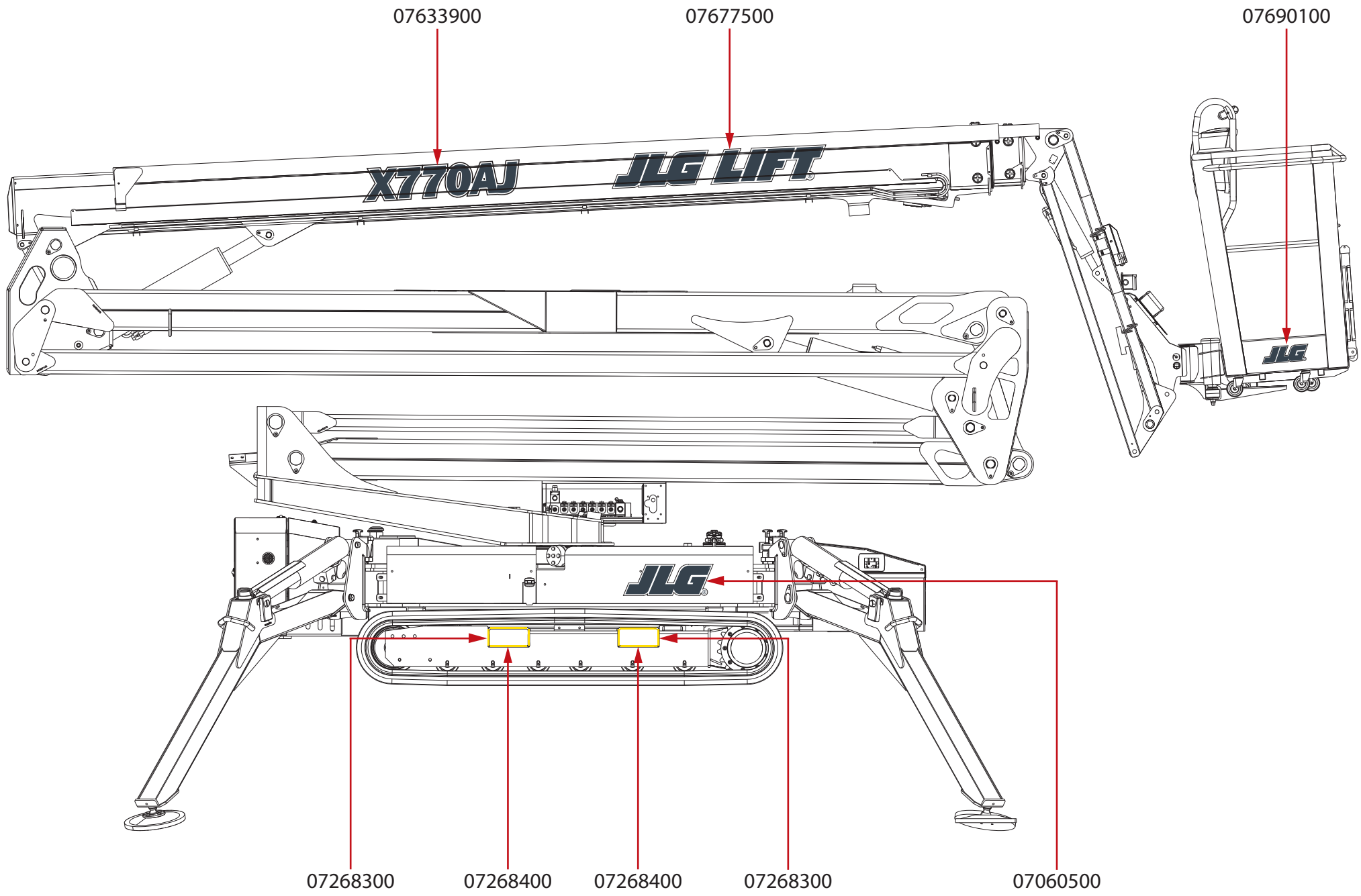

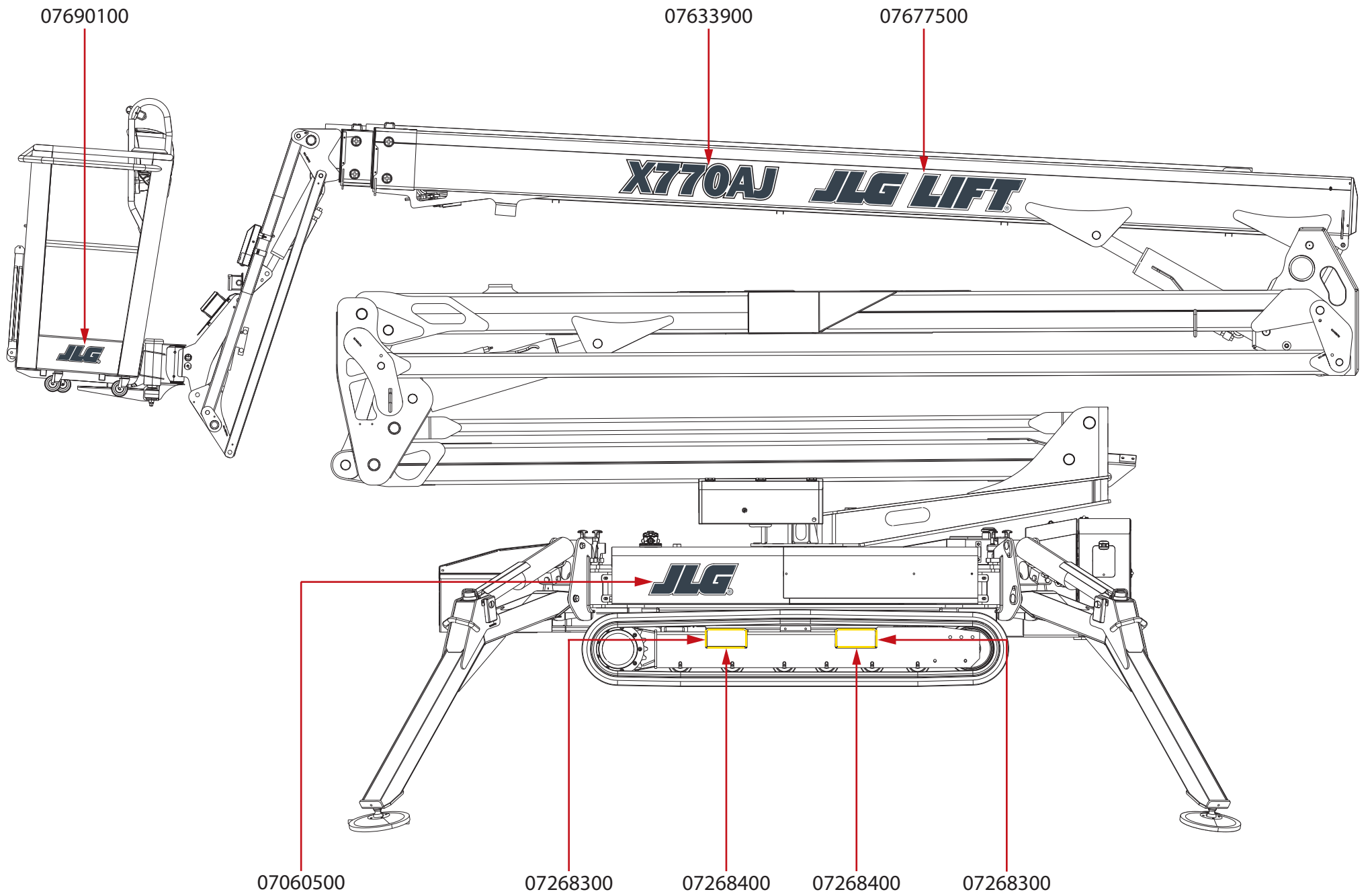

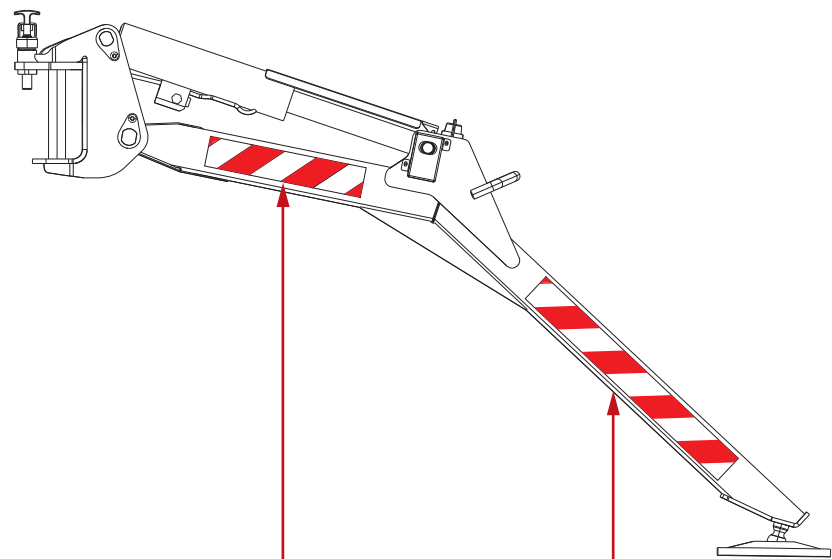
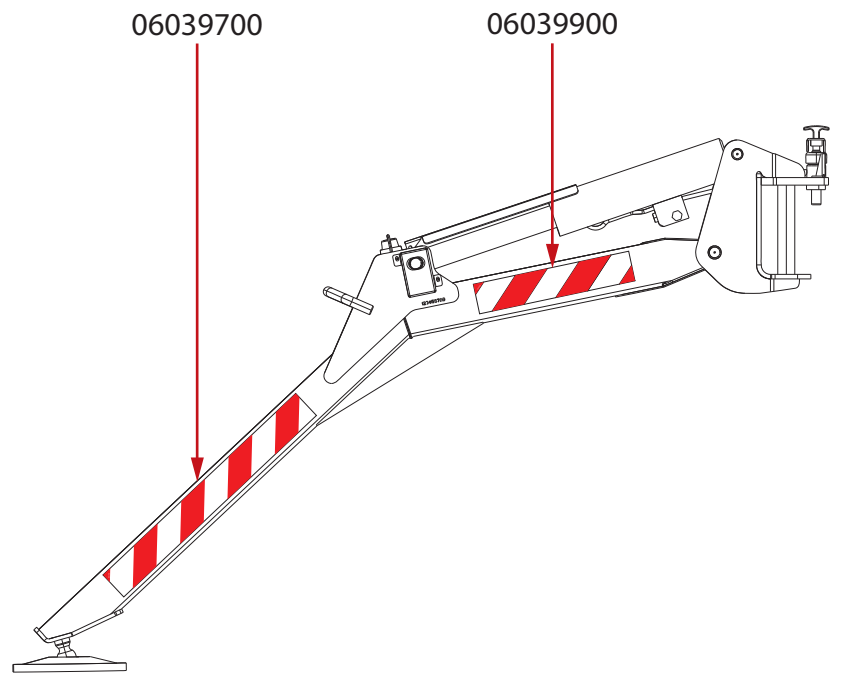

06039900

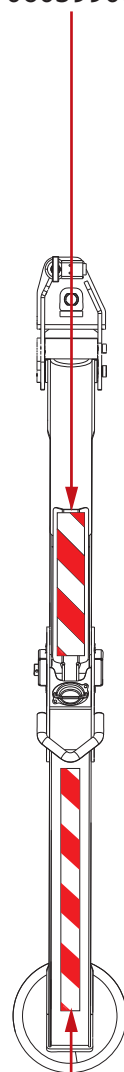

06039600

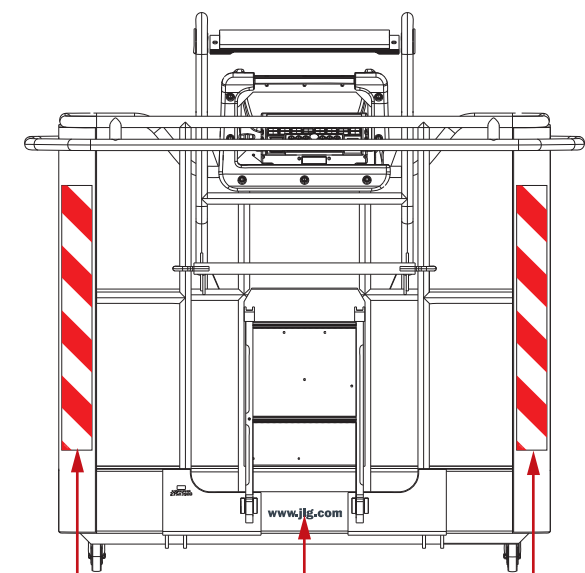

06039700

07691500

06039700

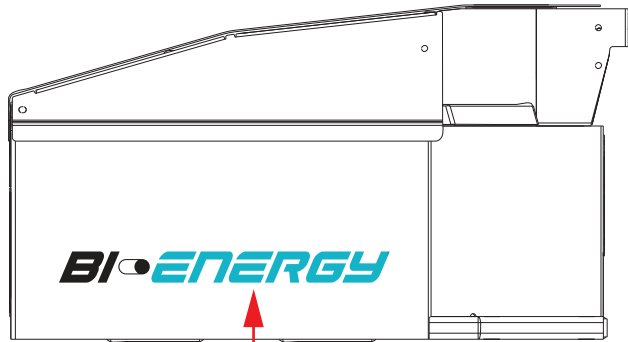

08294800

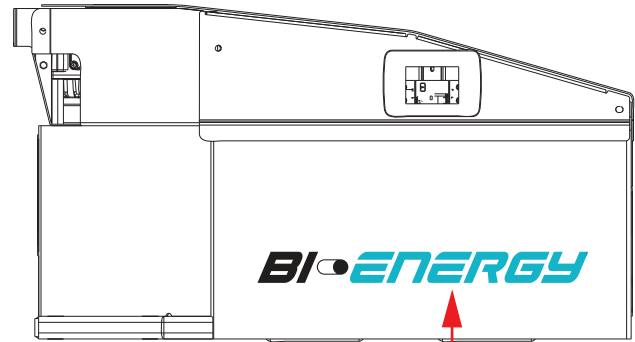

08294800





KIT INTEGRAZIONE ADESIVI  
CESTO RETTANGOLARE DSE

DECALS KIT INTEGRATION  
RECTANGULAR DSE BASKET

18374500

# HISTORY REVISION

<b>DATA/DATE</b>	<b>VERSION</b>	<b>MODIFICHE/CHANGES</b>	<b>AUTORE</b>
01/04/2021	1.0	Realizzata nuova versione senza foto. New version without photos.	Masaggia Mattia

**LISTA ADESIVI**  
**DECALS LIST**

<b>CODE</b>	<b>DESCRIZIONE</b>	<b>QTA'</b>
07058800	ADESIVO PERICOLO MANTENERE LE DISTANZE L=65X130 MM - GIALLO	2,00
08141300	ADESIVO NEW LOGO HINOWA GRAFFIATO H=40mm L=100mm	1,00
08347400	ADESIVO STRISCIA BIANCA E ROSSA H100 X L220 MM	2,00
08347500	ADESIVO STRISCIA BIANCA E ROSSA H100 X L350 MM	2,00
08318500	ADESIVO PRESPAZIATO CESTO DSE NERO	1,00

VEDI  
MODELLO  
MACCHINA

06040900

07878400

06040400

VEDI  
MODELLO  
MACCHINA

08141300

06448100

06448200

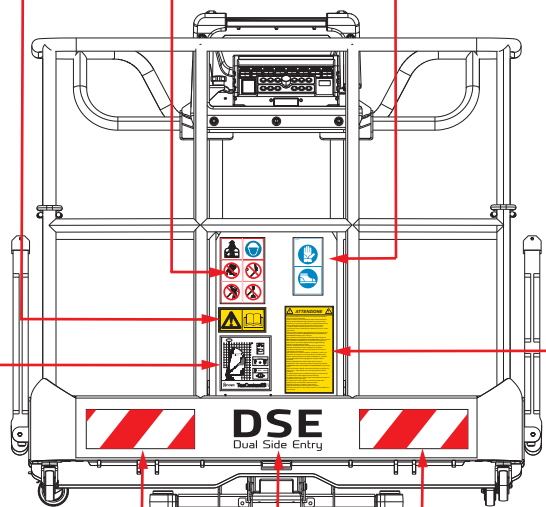

08347500

08318500

08347500

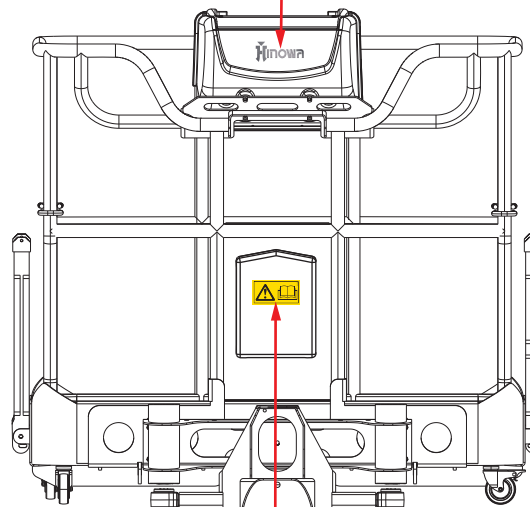

06040900

06448200

06448100



1001125483

1001125483

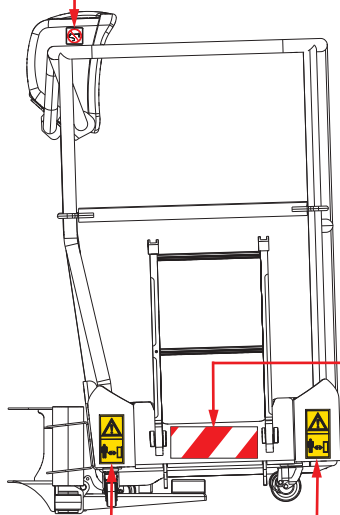

07058800

08347400

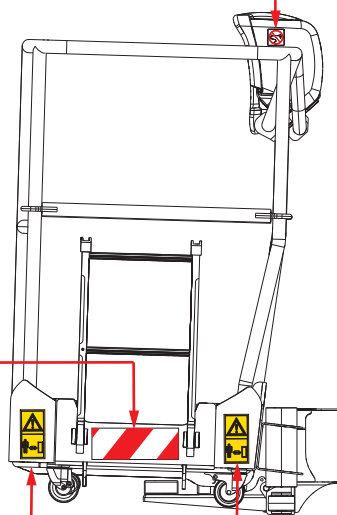

07058800

1704277

1704277

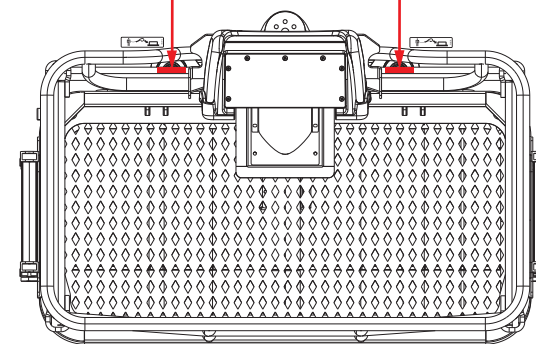

KIT INTEGRAZIONE ADESIVI  
CESTO RETTANGOLARE DSE ANSI

DECALS INTEGRATION KIT  
DSE RECTANGULAR BASKET ANSI

**18486500**



# HISTORY REVISION

<b>DATA/DATE</b>	<b>VERSION</b>	<b>MODIFICHE/CHANGES</b>	<b>AUTORE</b>
24/01/2022	1.0	Realizzato nuovo KIT New KIT made	Masaggia Mattia

**LISTA ADESIVI IN KIT CODE. 18486500****DECALS LIST KIT CODE 18486500**

POS	CODE			DESCRIZIONE DESCRIPTION	QTA QTY
	ENGLISH	FRENCH	PORTUGUESE		
L20	1706385	07118900	07123500	ADESIVO JLG SCORRIMENTO SBARRA CHIUSURA CESTO - ING L=184,15X25,4 MM_MOD_C	01

CODE	DESCRIPTION	QTY
1701640	ADESIVO JLG LEGGERE IL MANUALE L= 69,85x69,85 MM	01
08347500	ADESIVO STRISCIA BIANCA E ROSSA H100 X L350 MM	02
08347400	ADESIVO STRISCIA BIANCA E ROSSA H100 X L220 MM	02
07690100	ADESIVO JLG - LOGO JLG PER CESTO COLORE GRIGIO PANTONE 432C L=300x104,2 MM	01

LISTA ADESIVI CESTO COMPLETO COMPLETE BASKET DECALS LIST						
POS	CODE			DESCRIZIONE DESCRIPTION	QTA QTY	
	ENGLISH	FRENCH	PORTUGUESE			
L1	07056100	07116800	07121400	ADESIVO JLG PERICOLO SCHIACCIAMENTO - ING L= 140x60,71 MM	04	
L2	1706387	07119100	07123700	ADESIVO JLG PERICOLO SCHIACCIAMENTO - ING L=177,80x69,85 MM ( SUL CESTO )	01	
L4	1702868	07117800	07122400	ADESIVO JLG PERICOLO SCHIACCIAMENTO MANO - ING L= 241,30X25.40 MM_MOD_B (**)	01	
L6	1706386	071190000	07123600	ADESIVO JLG PERICOLO CADUTE - ING L=196,85x76,2 MM	01	
L7	07051100	07116700	07121300	ADESIVO JLG PERICOLO CADUTA - RIPRISTINARE I TAPPI - ING L=196,5x35 MM_MOD_B	01	
L8	07051000	07116600	07121200	ADESIVO JLG ATTENZ.CADUTE - SBLOCCARE SOLO NEI CASI PREVISTI - ING D Ø 60 FORO 4 MM (**)	02	
L9	1706133	07118700	07123300	ADESIVO JLG PERICOLO RIBALTAMENTO - ING L=139,7X68,85 MM_MOD_C	01	
L10	07058600	07117200	07121800	ADESIVO JLG POSIZIONE STABILIZZATORI X700 - ING L=139,7X68,85 MM	01	
L16	1706128	07118600	07123200	ADESIVO JLG PERICOLO FOLGORAZIONE - ING L=120,65x91,50 MM_MOD_E	01	
L19	081081GB	081081FR	081081PT	ADESIVO JLG/ANSI CARICO MAX IN CESTA 2 PERSONE X1000AJ - ING L=196,85x76,2 MM (INGLESE)	01	
L20	1706385	07118900	07123500	ADESIVO JLG SCORRIMENTO SBARRA CHIUSURA CESTO - ING L=184,15X25,4 MM_MOD_C	02	
L21	08069800			ADESIVO JLG ATTENZIONI PROP.65 L=101,6x57,1 MM RIF JLG CODE. 1001231801 C	01	

ADESIVI NON IN LINGUA / DECALS NOT IN LANGUAGE		
CODE	DESCRIPTION	QTY
1701640	ADESIVO JLG LEGGERE IL MANUALE L= 69,85x69,85 MM	02
08347500	ADESIVO STRISCIA BIANCA E ROSSA H100 X L350 MM	02
08347400	ADESIVO STRISCIA BIANCA E ROSSA H100 X L220 MM	02
1704277	DECAL,LANYARD ATTACH	02
07690100	ADESIVO JLG - LOGO JLG PER CESTO COLORE GRIGIO PANTONE 432C L=300x104,2 MM	01
1001125483	ADESIVO JLG VIETATO LAVARE L=63,5X63,5 MM	02

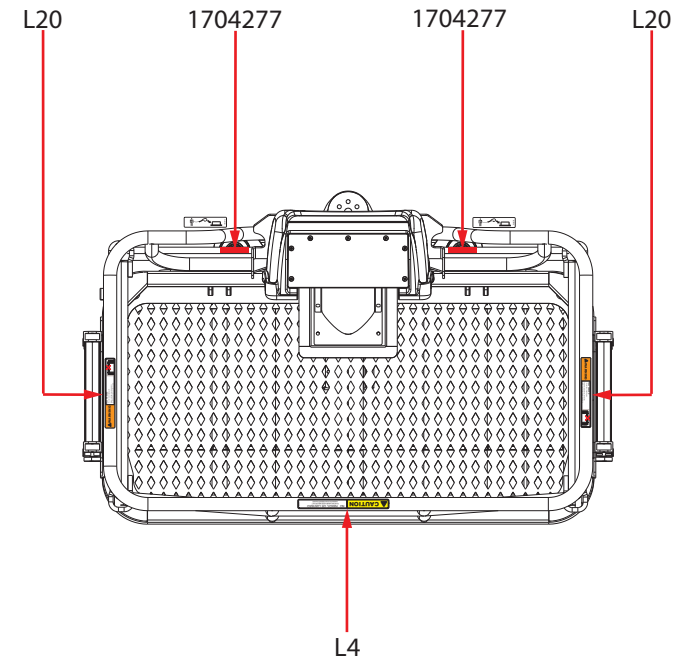
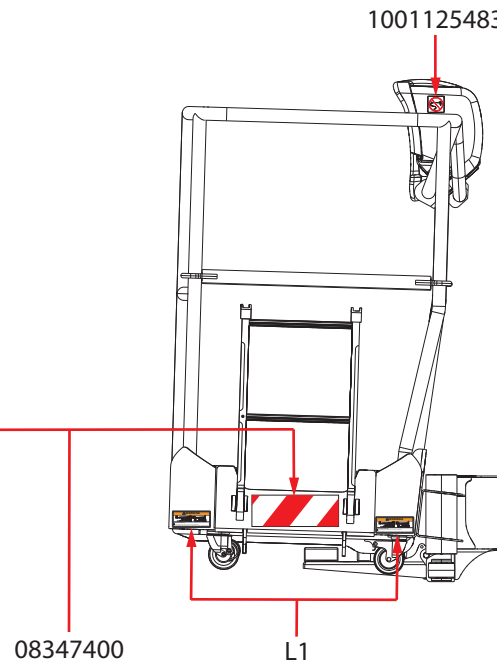
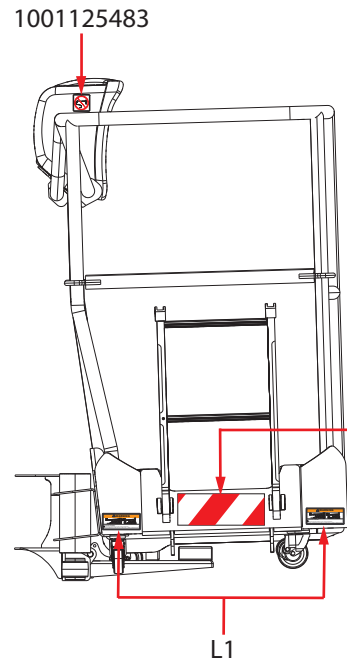
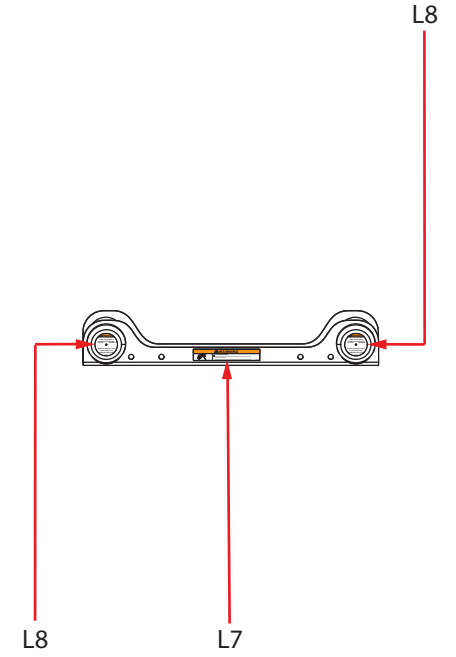
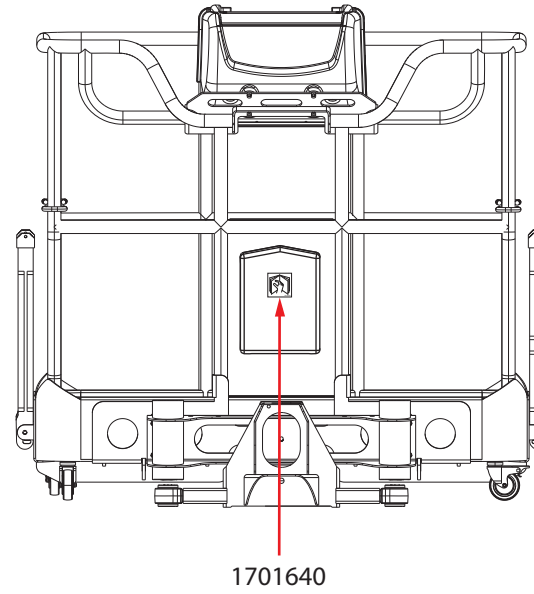
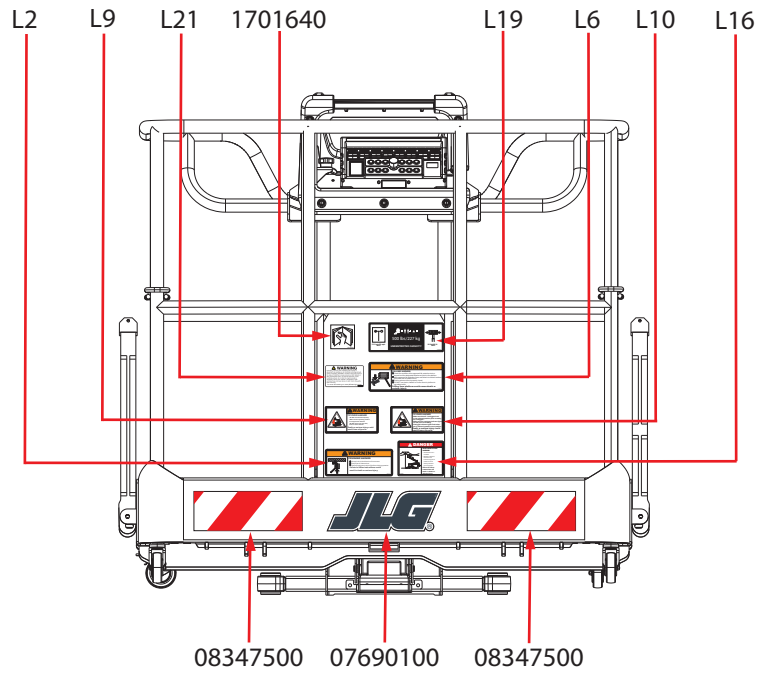





# TABELLA PERNI/SPINE (PINS TABLE)

LOCKING SYSTEM  
GHIERA  
(LOCKNUTS CODE)  
REF. TABLE BELOW

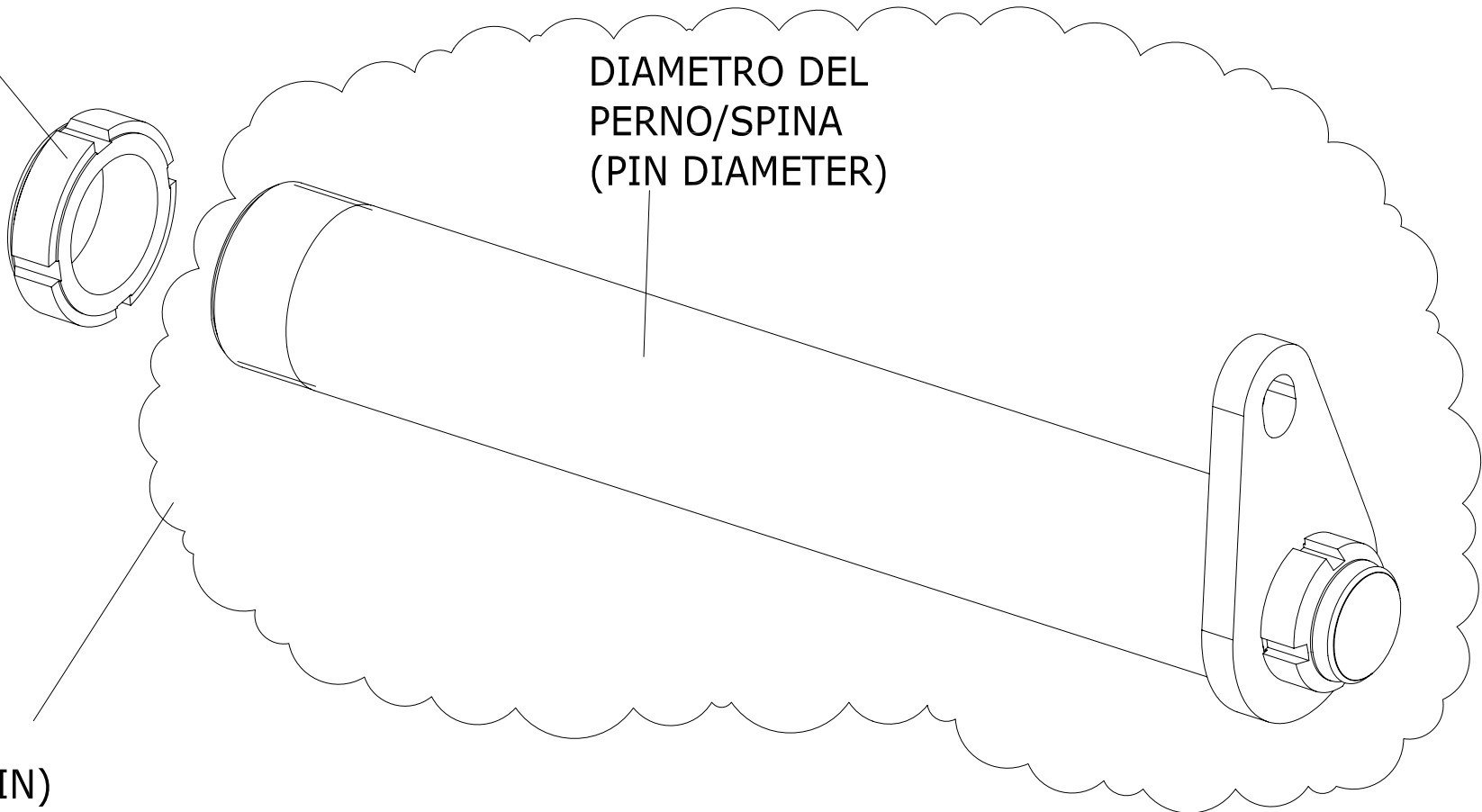

PERNO/SPINA (PIN)





IL CODICE DEL PERNO A RICAMBIO COMPRENDE LA GOCCIA MONTATA E LA GHIERA DI FISSAGGIO DELLA GOCCIA

THE CODE OF A PIN INCLUDES DROP PARTS MOUNTED AND THE LOCK NUT TO FIXING THE DROP, ALL THESE PARTS ARE SHIPPED ALREADY MOUNTED TOGETHER

<b>DIAMETRO DEL PERNO/SPINA mm SISTEMA METRICO (PIN DIAMETER mm METRIC)</b>	<b>GHIERA (LOCKNUTS CODE)</b>	<b>DADO (NUTS CODE)</b>
25	BG4	
30	BG5	
35	BG3	
40	BG2	
45	BG7	
50	BG8	
20 (DIAMETER OF THREADED PART M17 PITCH=1)	BG1	
20 (DIAMETER OF THREADED PART M20 PITCH=1)	BG6	
20 (DIAMETER OF THREADED PART M20 PITCH=1,5)	BG12	

07825700	BUSSOLA PER GHIERE S12GU
07825800	BUSSOLA PER GHIERE S17GU
07825900	BUSSOLA PER GHIERE S20GU
07826000	BUSSOLA PER GHIERE S25GU
07826100	BUSSOLA PER GHIERE S30GU
07826200	BUSSOLA PER GHIERE S35GU
07826300	BUSSOLA PER GHIERE S40GU
07826400	BUSSOLA PER GHIERE S45GU
07826500	BUSSOLA PER GHIERE S50GU
07826600	BUSSOLA PER GHIERE S55GU
07826700	BUSSOLA PER CHIARE S65GU

POS	Codice	U.M.	 Descrizione	 Description	 Designation	 Benennung	 Descripción
BC1	BC000100	NR	COPPIGLIA 4X40	COTTER PIN 4X40	GOUPILLE 4X40	SPLINT 4X40	CLAVIJA 4X40
BC2	BC000200	NR	COPPIGLIA 5X40	COTTER PIN 5X40			
BC3	BC000300	NR	SEEGER ESTERNO Ø20 GEOMET	SEEGER EXTERNAL Ø20 GEOMET	SEGER EXTERNE Ø20 GEOMET	EXTERNEN SEGER Ø20 GEOMET	SEGER ESTERNO Ø20 GEOMET
BC4	BC000400	NR	SEEGER ESTERNO Ø8	SEEGER EXTERNAL Ø8	CIRCLIP	RING	ANILLO
BC5	BC000500	NR	SEEGER ESTERNO Ø25 GEOMET	SEEGER EXTERNAL Ø25 GEOMET	SEEGER CIRCLIP	SEEGERRING	ANILLO DE RETENCIÓN SEEGER
BC6	BC000600	NR	COPPIGLIA 1,8X8	COTTER PIN 1,8X8			
BC7	BC000700	NR	COPPIGLIA 4X55	COTTER PIN 4X55	GOUPILLE 4X55	SPLINT 4X55	CLAVIJA 4X55
BC8	BC000800	NR	SEEGER ESTERNO Ø15	SEEGER EXTERNAL Ø15	CIRCLIP	RING	ANILLO
BC9	BC000900	NR	SEEGER ESTERNO Ø30	SEEGER EXTERNAL Ø30	CIRCLIP	RING	ANILLO
BC11	BC001100	NR	ANELLI ELASTICI X ALBERI (SEEGER) DIN 471 ACC.MOLLE 10 ZINCATA D. BIANCA	SNAP RINGS FOR SHAFTS (SEEGER) DIN 471 ACC. SPRINGS 10 Z WITHE	CIRCLIP	RING	ANILLO
BC12	BC001200	NR	ANELLI ELASTICI X ALBERI (SEEGER) DIN 471 ACC.MOLLE 12 GEO 321A	SNAP RINGS FOR SHAFTS (SEEGER) DIN 471 ACC. SPRINGS 12 GEO 321A	CIRCLIP	RING	ANILLO
BC13	BC001300	NR	ANELLI ELASTICI X FORI (SEEGER) DIN 472 ACC.MOLLE 33 GEO 321A	SNAP RINGS FOR HOLES (SEEGER) DIN 472 ACC. SPRINGS 33 GEO 321A	CIRCLIP	RING	ANILLO
BC14	BC001400	NR	ANELLI ELASTICI X FORI (SEEGER) DIN 472 ACC.MOLLE 62 GEO 321A	SNAP RINGS FOR HOLES (SEEGER) DIN 472 ACC. SPRINGS 62 GEO 321A	CIRCLIP	RING	ANILLO
BC15	BC001500	NR	ANELLI ELASTICI X FORI (SEEGER) DIN 472 ACC.MOLLE 75 GEO 321A	SNAP RINGS FOR HOLES (SEEGER) DIN 472 ACC. SPRINGS 75 GEO 321A	CIRCLIP	RING	ANILLO
BC16	BC001600	NR	COPIGLIA RICOTTA DIN 94 FERRO RICOTTO D 5 X 70 Z.BIANCA	COTTER PIN DIN 94 IRON ANNEALED D 5 X 70 Z. WHITE	CIRCLIP	RING	ANILLO

POS	Codice	U.M.	 Descrizione	 Description	 Designation	 Benennung	 Descripción
BC17	BC001700	NR	COPIGLIA ELASTICA DI SICUREZZA ACC.MOLLE D 2 Z.BIANCA	ELASTIC COTTER PIN ACC. SPRINGS D 2 Z. WHITE	CIRCLIP	RING	ANILLO
BC18	BC001800	NR	ANELLI ELASTICI X ALBERI (SEEGER) DIN 471 ACC.MOLLE 35 GEO 321A	SNAP RINGS FOR SHAFTS (SEEGER) DIN 471 ACC. SPRINGS 35 GEO 321A	CIRCLIP	RING	ANILLO
BC19	BC001900	NR	ANELLI ELASTICI X ALBERI (SEEGER) DIN 471 ACC.MOLLE 70 GEO 321A	SNAP RINGS FOR SHAFTS (SEEGER) DIN 471 ACC. SPRINGS 70 GEO 321A	CIRCLIP	RING	ANILLO
BC20	BC002000	NR	COPIGLIA RICOTTA DIN 94 FERRO RICOTTO D 5 X 50 Z.BIANCA	COTTER PIN DIN 94 IRON ANNEALED D 5 X 50 Z. WHITE	CIRCLIP	RING	ANILLO
BC21	BC002100	NR	ANELLI ELASTICI X FORI (SEEGER) DIN 472 ACC.MOLLE 55 GEO 321A	SNAP RINGS FOR HOLES (SEEGER) DIN 472 ACC. SPRINGS 55 GEO 321A	CIRCLIP	RING	ANILLO
BD1	BD000100	NR	DADO ESAGONALE FLANGIATO LISCIO PG DIN 6923 CL 8 M 14 Z.BIANCA	HEX FLANGE NUT DIN 6923 CL SMOOTH PG 8 M 14 Z. WHITE	ÉCROU HEXAGONAL BRIDÉ LISSE PG DIN 6923 CL 8 M 14 Z.BLANCHE	GEWINDE SECHSKANTMUTTER DIN 6923 CL SMOOTH PG 8 M 14 Z. WEIß	ARANDELA HEXAGONAL ROSCADA LISA DIN 6923 CL 8 M 14 GALVANIZADA BLANCA
BD2	BD000200	NR	DADO ESAGONALE BASSO PG DIN 936 CL 04 M 8 Z.BIANCA	LOW HEX NUT DIN 936 PG 04 M CL 8 Z. WHITE	ÉCROU HEXAGONAL BAS PG DIN 936 CL 04 M 8 GALVANISÉ BLANC	NUTTER	TUERCA
BD3	BD000300	NR	DADO ESAGONALE ALTO PG UNI 5587 CL 8 M 8 Z.BIANCA	HEX NUT HIGH PG UNI 5587 CL 8 M 8 Z. WHITE	ÉCROU HEXAGONAL PG UNI 5587 CL 8 M 8 Z.BLANCHE	HOHE SECHSKANTMUTTER PG UNI 5587 CL 8 M 8 Z. WEIß	ARANDELA ALTA HEXAGONAL UNI 5587 CL 8 M 8 GALVANIZADA BLANCA
BD4	BD000400	NR	DADO ALTO AUTOBLOCCANTE PG DIN 982 CL 8 M 12 Z.BIANCA	HIGH SELF LOCKING NUT DIN 982 PG 12 CL 8 M Z. WHITE	HAUT ÉCROU AUTOBLOQUANT DIN 982 PG 12 CL 8 M Z. BLANCHE	HOHE SELBSTSICHERUNGSMUTTER DIN 982 PG 12 CL 8 M Z. WEIß	ARANDELA ALTA AUTOBLOCANTE DIN 982 CL 8 M 12 GALVANIZADA BLANCA
BD5	BD000500	NR	DADO ALTO AUTOBLOCCANTE PG DIN 982 CL 8 M 8 Z.BIANCA	HIGH SELF LOCKING NUT DIN 982 PG CL 8 M 8 Z. WHITE	HAUT ÉCROU AUTOBLOQUAND DIN 982 PG CL 8 M 8 Z. BLANCHE	HOHE SELBSTSICHERUNGSMUTTER DIN 982 PG CL 8 M 8 Z. WEIß	ARANDELA ALTA AUTOBLOCANTE DIN 982 CL 8 M 8 GALVANIZADA BLANCA
BD6	BD000600	NR	DADO ESAGONALE ALTO PG UNI 5587 CL 8 M 4 Z.BIANCA	HEX NUT HIGH PG UNI 5587 M 4 CL 8 Z. WHITE	ÉCROU HEXAGONAL HAUT PG UNI 5587 CL 8 M 4 GALVANISÉ BLANC	NUTTER	TUERCA





POS	Codice	U.M.	 Descrizione	 Description	 Designation	 Benennung	 Descripción
BD7	BD000700	NR	DADO ESAGONALE BASSO PG DIN 936 CL 04 M 6 Z.BIANCA	LOW HEX NUT DIN 936 PG 6 CL 04 M Z. WHITE	ÉCROU BAS HEXAGONAL DIN 936 PG 6 CL 04 M Z. BLANCHE	NIEDRIGE SECHSKANTMUTTER DIN 936 PG 6 CL 04 M Z. WEIß	ARANDELA BAJA HEXAGONAL DIN 936 CL 04 M 6 GALVANIZADA BLANCA
BD8	BD000800	NR	DADO BASSO AUTOBLOCCANTE PG DIN 985 CL 8 M 6 Z.BIANCA	LOW SELF-LOCKING NUT DIN 985 PG 6 CL 8 M Z. WHITE	ÉCROU BAS AUTOBLOQUANT DIN 985 PG 6 CL 8 M Z. BLANCHE	NIEDRIGE SELBSTSICHERUNGSMUTTER DIN 985 PG 6 CL 8 M Z. WEIß	ARANDELA BAJA AUTOBLOCANTE DIN 985 CL 8 M 6 GALVANIZADA BLANCA
BD9	BD000900	NR	DADO ALTO AUTOBLOCCANTE PG DIN 982 CL 8 M 6 Z.BIANCA	HIGH SELF LOCKING NUT DIN 982 PG CL 8 M6 Z. WHITE	ÉCROU HAUT AUTOBLOQUANT NUT DIN 982 PG CL 8 M6 Z. BLANCHE	SELBSTSICHERUNGSMUTTER DIN 982 PG CL 8 M6 Z. WEIß	TUERCA AUTOBLOCANTE ALTA DIN 982 CL 8 M 6 GALVANIZADA BLANCA
BD10	BD001000	NR	DADO BASSO AUTOBLOCCANTE PG DIN 985 CL 8 M 5 Z.BIANCA	LOW SELF-LOCKING NUT DIN 985 PG CL 8 M5 Z. WHITE	ÉCROU BAS AUTOBLOQUANT PG DIN 985 CL 8 M 5 GALVANISÉ BLANC	NUTTER	TUERCA
BD11	BD001100	NR	DADO ALTO AUTOBLOCCANTE PG DIN 982 CL 8 M 5 Z.BIANCA	HIGH SELF LOCKING NUT DIN 982 PG CL 8 M5 Z. WHITE	ÉCROU HAUT AUTOBLOQUANT PG DIN 982 CL 8 M 5 Z.BLANCHE	SELBSTSICHERUNGSMUTTER DIN 982 PG CL 8 M5 Z. WEIß	TUERCA AUTOBLOCANTE ALTA PG DIN 982 CL 8 M 5 GALVANIZADA BLANCA
BD12	BD001200	NR	DADO ALTO AUTOBLOCCANTE PG DIN 982 CL 8 M 4 Z.BIANCA	HIGH SELF LOCKING NUT DIN 982 PG CL 8 M4 Z. WHITE	ÉCROU HAUT AUTOBLOQUANT PG DIN 982 CL 8 M 4 Z.BLANCHE	SELBSTSICHERUNGSMUTTER DIN 982 PG CL 8 M4 Z. WEIß	TUERCA ALTA AUTOBLOCANTE PG DIN 982 CL 8 M 4 GALVANIZADO BLANCA
BD13	BD001300	NR	DADO ALTO AUTOBLOCCANTE PG DIN 982 CL 8 M 3 Z.BIANCA	HIGH SELF LOCKING NUT DIN 982 PG CL 8 M3 Z. WHITE	ÉCROU HAUT AUTOBLOQUANT PG DIN 982 CL 8 M 3 GALVANISÉ BLANC	NUTTER	TUERCA
BD14	BD001400	NR	DADO ALTO AUTOBLOCCANTE PF DIN 982 CL 8 M 20 X 1,5 Z.BIANCA	HIGH SELF LOCKING NUT DIN 982 PF CL 8 M 20 X 1.5 Z WHITE	ÉCROU HAUT AUTOBLOQUANT PF DIN 982 CL 8 M 20 X 1,5 Z.BLANCHE	SELBSTSICHERUNGSMUTTER DIN 982 PF CL 8 M 20 X 1.5 Z WEIß	TUERCA AUTOBLOCANTE ALTA DIN 982 CL 8 M 20 X 1,5 GALVANIZADA BLANCA
BD15	BD001500	NR	DADO ALTO AUTOBLOCCANTE PG DIN 982 CL 8 M 10 Z.BIANCA	HIGH SELF LOCKING NUT DIN 982 PG CL 8 M10 Z. WHITE	ÉCROU HAUT AUTOBLOQUANT DIN 982 PG CL 8 M10 Z. BLANCHE	SELBSTSICHERUNGSMUTTER DIN 982 PG CL 8 M10 Z. WEIß	TUERCA AUTOBLOCANTE ALTA DIN 982 CL 8 M 10 GALVANIZADA BLANCA
BD16	BD001600	NR	DADO ESAGONALE ALTO PG UNI 5587 CL 8 M 3 Z.BIANCA	HEX NUT HIGH PG UNI 5587 CL 8 M3 Z. WHITE	ÉCROU HEXAGONAL HAUT PG UNI 5587 CL 8 M 3 GALVANISÉ BLANC	NUTTER	TUERCA
BD17	BD001700	NR	DADO BASSO AUTOBLOCCANTE PG DIN 985 CL 8 M 8 Z.BIANCA	LOW SELF-LOCKING NUT DIN 985 PG CL 8 M8 Z. WHITE	ÉCROU BAS AUTOBLOQUANT PG DIN 985 CL 8 M 8 Z.BLANCHE	SELBSTSICHERUNGSMUTTER DIN 985 PG CL 8 M8 Z. WEIß	TUERCA BAJA AUTOBLOCANTE DIN 985 CL 8 M 8 GALVANIZADA BLANCA







POS	Codice	U.M.	 Descrizione	 Description	 Designation	 Benennung	 Descripción
BD18	BD001800	NR	DADO ALTO AUTOBLOCCANTE PG DIN 982 CL 8 M 16 Z.BIANCA	HIGH SELF LOCKING NUT DIN 982 PG CL 8 M16 Z. WHITE	ÉCROU AUTOBLOQUANT PG DIN 982 CL 8 M 16 GALVANISÉ BLANC	NUTTER	TUERCA
BD22	BD002200	NR	DADO ALTO AUTOBLOCCANTE PG DIN 982 CL 8 M 14 Z.BIANCA	HEX FLANGE NUT DIN 982 CL 8 M 14 Z. WHITE	ÉCROU HAUT AUTOBLOQUANT PG DIN 982 CL 8 M 14 Z.BLANCHE	SELBSTSICHERUNGSMUTTER DIN 982 CL 8 M 14 Z. WEIß	TUERCA ALTA AUTOBLOCANTE 982 CL 8 M 14 GALVANIZADA BLANCA
BD23	BD002300	NR	DADO BASSO AUTOBLOCCANTE PG DIN 985 CL 8 M 10 Z.BIANCA	LOW SELF-LOCKING NUT DIN 985 PG CL 8 M 10 Z. WHITE	ÉCROU BAS AUTOBLAQUANT PG DIN 985 CL 8 M 10 GALVANISÉ BLANC	NUTTER	TUERCA
BD24	BD002400	NR	DADO ALTO AUTOBLOCCANTE PG DIN 982 CL 8 M 24 Z.BIANCA	HIGH SELF LOCKING NUT DIN 982 PG CL 8 M24 Z. WHITE	ÉCROU HAUT AUTOBLOQUANT PG DIN 982 CL 8 M 24 GALVANISÉ BLANC	NUTTER	TUERCA
BD25	BD002500	NR	DADO ESAGONALE ALTO PG UNI 5587 CL 8 M 6 Z.BIANCA	HEX NUT HIGH PG UNI 5587 M 6 CL 8 Z. WHITE	ÉCROU HEXAGONAL HAUT PG UNI 5587 CL 8 M 6 Z.BLANCHE	SECHSKANTMUTTER PG UNI 5587 M 6 CL 8 Z. WEIß	TUERCA ALTA HEXAGONAL UNI 5587 CL 8 M 6 GALVANIZADA BLANCA
BD26	BD002600	NR	DADO ESAGONALE ALTO PG UNI 5587 CL 10 M 10 Z.BIANCA	HEX NUT HIGH PG UNI 5587 M 10 CL 10 Z. WHITE	ÉCROU HEXAGONAL HAUT PG UNI 5587 CL 10 M 10 Z.BLANCHE	SECHSKANTMUTTER PG UNI 5587 M 10 CL 10 Z. WEIß	TUERCA ALTA HEXAGONAL UNI 5587 CL 10 M 10 GALVANIZADA BLANCA
BD27	BD002700	NR	DADO ALTO AUTOBLOCCANTE PG DIN 982 CL 8 M 18 Z.BIANCA	HIGH SELF LOCKING NUT DIN 982 PG CL 8 M18 Z. WHITE	ÉCROU HAUT AUTOBLOQUANT PG DIN 982 CL 8 M 18 Z.BLANCHE	SELBSTSICHERUNGSMUTTER DIN 982 PG CL 8 M18 Z. WEIß	TUERCA ALTA AUTOBLOCANTE DIN 982 CL 8 M 18 GALVANIZADA BLANCA
BD28	BD002800	NR	DADO BASSO AUTOBLOCCANTE PG DIN 985 CL 8 M 16 Z.BIANCA	LOW SELF-LOCKING NUT DIN 985 PG CL 8 M 16 Z. WHITE	ÉCROU BAS AUTOBLOQUANT PG DIN 985 CL 8 M 16 GALVANISÉ BLANC	NIEDRIGE SELBSTSICHERUNGSMUTTER DIN 985 PG CL 8 M 16 Z. WEIß	TUERCA BAJA AUTOBLOCANTE PG DIN 985 CL 8 M 16 GALVANIZADA BLANCA
BD29	BD002900	NR	DADO ESAGONALE ALTO PG UNI 5587 CL 8 M 5 Z.BIANCA	HEX NUT HIGH PG UNI 5587 M 5 CL 8 Z. WHITE	ÉCROU HEXAGONAL HAUT PG UNI 5587 CL 8 M 5 Z.BLANCHE	SECHSKANTMUTTER PG UNI 5587 M 5 CL 8 Z. WEIß	TUERCA ALTA HEXAGONAL UNI 5587 CL 8 M 5 GALVANIZADA BLANCA
BD30	BD003000	NR	DADO ESAGONALE ALTO PG UNI 5587 CL 12 M 5 Z.BIANCA	HEX NUT HIGH PG UNI 5587 M 5 CL 12 Z. WHITE	ÉCROU HEXAGONAL HAUT PG UNI 5587 CL 12 M 5 Z.BLANCHE	SECHSKANTMUTTER PG UNI 5587 M 5 CL 12 Z. WEIß	TUERCA ALTA HEXAGONAL UNI 5587 CL 12 M 5 GALVANIZADA BLANCA
BD31	BD003100	NR	DADO ESAGONALE ALTO PG UNI 5587 CL 16 M 5 Z.BIANCA	HEX NUT HIGH PG UNI 5587 M 5 CL 16 Z. WHITE	ÉCROU HEXAGONAL HAUT PG UNI 5587 CL 16 M 5 Z.BLANCHE	SECHSKANTMUTTER PG UNI 5587 M 5 CL 16 Z. WEIß	TUERCA ALTA HEXAGONAL UNI 5587 CL 16 M 5 GALVANIZADA BLANCA

POS	Codice	U.M.	 Descrizione	 Description	 Designation	 Benennung	 Descripción
BD32	BD003200	NR	DADO ALTO AUTOBLOCCANTE PG DIN 982 CL 8 M 20 Z.BIANCA	HIGH SELF LOCKING NUT DIN 982 PG CL 8 M20 Z. WHITE	ÉCROU HAUT AUTOBLOQUANT PG DIN 982 CL 8 M 20 GALVANISÉ BLANC	NUTTER	TUERCA
BD33	BD003300	NR	DADO BASSO AUTOBLOCCANTE PG DIN 985 CL 8 M 12 Z.BIANCA	LOW SELF-LOCKING NUT DIN 985 PG CL 8 M 12 Z. WHITE	ÉCROU BAS AUTOBLAQUANT PG DIN 985 CL 8 M 12 GALVANISÉ BLANC	NUTTER	TUERCA
BD35	BD003500	NR	DADO ESAGONALE ALTO PG UNI 5587 CL 10 M 12 Z.BIANCA	HEXAGON NUT ALTO UNI 5587 CL 10 M 12 Z. WHITE	ÉCROU	NUTTER	TUERCA
BD36	BD003600	NR	DADO ESAGONALE ALTO PG UNI 5587 CL 10 M 16 Z.BIANCA	HEXAGON NUT ALTO UNI 5587 CL 10 M 16 Z. WHITE	ÉCROU	NUTTER	TUERCA
BD37	BD003700	NR	DADO ESAGONALE ALTO PG UNI 5587 CL 8 M 20 Z.BIANCA	HEXAGON NUT ALTO UNI 5587 CL 8 M 20 Z. WHITE	ÉCROU	NUTTER	TUERCA
BD39	BD003900	NR	DADO ALTO AUTOBLOCCANTE PG DIN 982 CL 8 M 22 Z.BIANCA	HIGH SELF-LOCKING NUT DIN 982 CL 8 M 22 Z. WHITE	ÉCROU	NUTTER	TUERCA
BD40	BD004000	NR	DADO BASSO AUTOBLOCCANTE PG DIN 985 CL 8 M 14 Z.BIANCA	LOW SELF-LOCKING NUT DIN 985 CL 8 M 14 Z. WHITE	ÉCROU	NUTTER	TUERCA
BD41	BD004100	NR	DADO ESAGONALE MEDIO PF DIN 934 CL 10 M 16 X 1,5 Z.BIANCA	MEDIUM HEXAGONAL NUT PF DIN 934 CL 10 M 16 X 1.5 Z.BIANCA	ÉCROU HEXAGONAL	NUTTER	TUERCA
BD42	BD004200	NR	DADO ALTO PG DIN 982 CL 8 M 24 Z.BIANCA	HIGH NUT DIN 982 PG CL 8 M24 Z. WHITE	ÉCROU PG DIN 982 CL 8 M 24 GALVANISÉ BLANC	NUTTER	TUERCA
BD45	BD004500	NR	DADO ESAGONALE BASSO MB DIN439 INOX A2 M10 X 1	LOW NUT DIN439 INOX MB M10 X 1	ÉCROU BAS DIN439 INOX MB M10 X 1	NUTTER	TUERCA
BD46	BD004600	NR	DADO ALTO AUTOBLOCCANTE PG DIN 982 INOX A2 M4	NUT PG DIN 982 INOX A2 M4	ÉCROU PG DIN 982 INOX A2 M4	NUTTER	TUERCA
BG1	BG000100	NR	GHIERA AUTOBLOCCANTE GN CL 6 GN 3 D. 17 X 1 Z.BIANCA	SELF-LOCKING NUT GN GN 3 CL 6 D. 17 X 1 Z. WHITE			
BG2	BG000200	NR	GHIERA AUTOBLOCCANTE PESANTE CL 6 GUP 40 X 1,5 Z.BIANCA	SELF-LOCKING NUT HEAVY CL 6 GUP 40 X 1.5 Z WHITE			

POS	Codice	U.M.	 Descrizione	 Description	 Designation	 Benennung	 Descripción
BG3	BG000300	NR	GHIERA AUTOBLOCCANTE PESANTE CL 6 GUP 35 X 1,5 Z.BIANCA	SELF-LOCKING NUT HEAVY CL 6 GUP 35 X 1.5 Z WHITE			
BG4	BG000400	NR	GHIERA AUTOBLOCCANTE PESANTE CL 6 GUP 25 X 1,5 Z.BIANCA	SELF-LOCKING NUT HEAVY CL 6 GUP 25 X 1.5 Z WHITE	ÉCROU AUTO-BLOQUANT	SELBSTSICHERNDE NUTMUTTER	
BG5	BG000500	NR	GHIERA AUTOBLOCCANTE PESANTE CL 6 GUP 30 X 1,5 Z.BIANCA	SELF-LOCKING NUT HEAVY CL 6 GUP 30 X 1.5 Z WHITE	BAGUE AUTOBLOQUANT LOURDE CL 6 GUP 30 X 1,5 Z.BLANCHE	SELBSTSICHERUNGSNUTMUTTER CL 6 GUP 30 X 1.5 Z WEIß	CASQUILLO AUTOBLOCANTE CL 6 GUP 30 X 1,5 GALVANIZADO BLANCO
BG6	BG000600	NR	GHIERA AUTOBLOCCANTE PESANTE CL 6 GUP 20 X 1 Z.BIANCA	SELF-LOCKING NUT HEAVY CL 6 GUP 20 X 1 Z. WHITE	BAGUE AUTOBLOQUANTE CL 6 GUP 20 X 1 Z.BLANCHE	SELBSTSICHERUNGSNUTMUTTER CL 6 GUP 20 X 1 Z. WEIß	CASQUILLO AUTOBLOCANTE CL 6 GUP 20 X 1 GALVANIZADO BLANCO
BG7	BG000700	NR	GHIERA AUTOBLOCCANTE GN CL 6 GN 3 D. 45 X 1,5 Z.BIANCA	NUT	BAGUE	NUTMUTTER	TUERCA
BG8	BG000800	NR	GHIERA AUTOBLOCCANTE GN CL 6 GN 3 D. 50 X 1,5 Z.BIANCA	NUT	BAGUE	NUTMUTTER	TUERCA
BG9	BG000900	NR	GHIERA AUTOBLOCCANTE GN CL 6 GN 3 D. 20 X 1,5 Z.BIANCA	NUT	BAGUE	NUTMUTTER	TUERCA
BG10	BG001000	NR	GHIERA AUTOBLOCCANTE RIBASSATA CL 6 GUK 25 X 1,5 Z.BIANCA	SELF-LOCKING NUT LOWERED CL 6 GUK 25 X 1.5 Z.BIANCA	BAGUE	NUTMUTTER	TUERCA
BG11	BG001100	NR	GHIERA AUTOBLOCCANTE RIBASSATA CL 6 GUK 20 X 1 Z.BIANCA	SELF-LOCKING NUT LOWERED CL 6 GUK 20 X 1 Z.BIANCA	BAGUE	NUTMUTTER	TUERCA
BG12	BG001200	NR	GHIERA AUTOBLOCCANTE RIBASSATA CL 6 GUA 20 X 1.5 Z.BIANCA	SELF-LOCKING NUT LOWERED CL 6 GUA 20 X 1.5 Z.BIANCA	BAGUE	NUTMUTTER	TUERCA
BG13	BG001300	NR	GHIERA AUTOBLOCCANTE RIBASSATA CL 6 GUK 30 X 1.5 Z.BIANCA	SELF-LOCKING NUT LOWERED CL 6 GUK 30 X 1.5 Z.BIANCA	BAGUE	NUTMUTTER	TUERCA
BG14	BG001400	NR	GHIERA AUTOBLOCCANTE RIBASSATA CL 6 GUK 45 X 1.5 Z.BIANCA	SELF-LOCKING NUT LOWERED CL 6 GUK 45 X 1.5 Z.BIANCA	BAGUE	NUTMUTTER	TUERCA

POS	Codice	U.M.	 Descrizione	 Description	 Designation	 Benennung	 Descripción
BG15	BG001500	NR	GHIERA AUTOBLOCCANTE RIBASSATA CL 6 GUK 50 X 1.5 Z.BIANCA	SELF-LOCKING NUT LOWERED CL 6 GUK 50 X 1.5 Z.BIANCA	BAGUE	NUTMUTTER	TUERCA
BG16	BG001600	NR	GHIERA AUTOBLOCCANTE RIBASSATA CL 6 GUK 55 X 2 Z.BIANCA	SELF-LOCKING NUT LOWERED CL 6 GUK 55 X 2 Z.BIANCA	BAGUE	NUTMUTTER	TUERCA
BG17	BG001700	NR	GHIERA AUTOBLOCCANTE GN CL 6 GN 1 D. 12 X 1 Z.BIANCA	SELF-LOCKING NUT GN CL 6 GN 1 D. 12 X 1 Z. WHITE	BAGUE	NUTMUTTER	TUERCA
BG18	BG001800	NR	GHIERA AUTOBLOCCANTE GN CL 6 GN 3 D. 65 X 2 Z.BIANCA	NUT	BAGUE	NUTMUTTER	TUERCA
BI1	BI000100	NR	INSERTO ESAGONALE M6	INSERT HEX M6	INSERT FILETE M9 TETE REDUITE	GEWINDEINSERT M9 REDUZIERTER KOPF	INSERTO ROSCADO M9 CABEZA REDUCIDA
BI2	BI000200	NR	INSERTO ESAGONALE M5	INSERT HEX M5	INSERT FILETE M5 TETE REDUITE	GEWINDEINSERT M5 REDUZIERTER KOPF	INSERTO ROSCADO M5 CABEZA REDUCIDA
BI3	BI000300	NR	INSERTO CILINDRICO M4	INSERT M4			
BI4	BI000400	NR	INSERTO CILINDRICO M6	INSERT M6			
BI5	BI000500	NR	INSERTO ESAGONALE M8	INSERT HEX M8	INSERT FILETE M8 TETE REDUITE	GEWINDEINSERT M8 REDUZIERTER KOPF	INSERTO ROSCADO M8 CABEZA REDUCIDA
BI6	BI000600	NR	INSERTO ESAGONALE M4	INSERT HEX M4	INSERT FILETE M4 TETE REDUITE	GEWINDEINSERT M4 REDUZIERTER KOPF	INSERTO ROSCADO M4 CABEZA REDUCIDA
BI7	BI000700	NR	INSERTO CILINDRICO M8	INSERT M8			
BR1	BR000100	NR	GROWER SEZ.RETT.SPIGOLI VIVI PESANTE UNI 9195 ACC.MOLLE D 6 Z.D.BIANCA	GROWER SEZ.RETT. SHARP HEAVY UNI 9195 ACC.MOLLE D 6 Z.D. WHITE	RONDELLE GROWER SECT.RECT. UNI 9195 ACC.MOLLE D 6 GALVANISÉE BLANCHE	GROWER UNTERLEGSCHIEBE UNI 9195 D 6 Z.D. WEIß	ARANDELA GROWER SEC. RECT. UNI 9195 D 6 GALVANIZADA BLANCA
BR2	BR000200	NR	RONDELLA PIANA DIN 125-A HV100 D 4 Z.BIANCA	PLAIN WASHER DIN 125-A HV100 D 4 Z. WHITE	RONDELLE PLATE DIN 125-A HV100 D 4 Z.BLANCHE	FLACHE UNTERLEGSCHIEBE DIN 125-A HV100 D 4 Z.WEIß	ARANDELA PLANA DIN 125-A HV100 D 4 GALVANIZADA BLANCA
BR3	BR000300	NR	RONDELLA PIANA DIN 125-A HV100 D 5 Z.BIANCA	PLAIN WASHER DIN 125-A HV100 D 5 Z. WHITE	RONDELLE PLATE DIN 125-A HV100 D 5 Z.BLANCHE	FLACHE UNTERLEGSCHIEBE DIN 125-A HV100 D 5 Z.WEIß	ARANDELA PLANA DIN 125-A HV100 D 5 GALVANIZADA BLANCA

POS	Codice	U.M.	 Descrizione	 Description	 Designation	 Benennung	 Descripción
BR4	BR000400	NR	RONDELLA PIANA DIN 125-A HV100 D 6 Z.BIANCA	PLAIN WASHER DIN 125-A HV100 D 6 Z. WHITE	RONDELLE PLATE DIN 125-A HV100 D 6 Z.BLANCHE	FLACHE UNTERLEGSCHLEIBE DIN 125-A HV100 D 6 Z. WEIß	ARANDELA PLANA DIN 125-A HV100 D 6 GALVANIZADA BLANCA
BR5	BR000500	NR	RONDELLA PIANA DIN 125-A HV100 D 8 Z.BIANCA	PLAIN WASHER DIN 125-A HV100 D 8 Z. WHITE	RONDELLE PLATE DIN 125-A HV100 D 8 Z.BLANCHE	FLACHE UNTERLEGSCHLEIBE DIN 125-A HV100 D 8 Z. WEIß	ARANDELA PLANA DIN 125-A HV100 D 8 GALVANIZADA BLANCA
BR6	BR000600	NR	RONDELLA PIANA DIN 125-A HV100 D 10 Z.BIANCA	PLAIN WASHER DIN 125-A HV100 D 10 Z. WHITE	RONDELLE PLATE DIN 125-A HV100 D 10 Z.BLANCHE	FLACHE UNTERLEGSCHLEIBE DIN 125-A HV100 D 10 Z. WEIß	ARANDELA PLANA DIN 125-A HV100 D 10 GALVANIZADA BLANCA
BR7	BR000700	NR	RONDELLA PIANA DIN 125-A HV100 D 12 Z.BIANCA	PLAIN WASHER DIN 125-A HV100 D 12 Z. WHITE	RONDELLE PLATE DIN 125-A HV100 D 12 Z.BLANCHE	FLACHE UNTERLEGSCHLEIBE DIN 125-A HV100 D 12 Z. WEIß	ARANDELA PLANA DIN 125-A HV100 D 12 GALVANIZADA BLANCA
BR8	BR000800	NR	ROSETTA PIANA FASCIA LARGA E=3D DIN 9021 HV100 D 10 X 30 X 2,5 Z.BIANCA	WIDE BAND AND FLAT WASHER DIN 9021 HV100 3D = D 10 X 30 X 2.5 Z WHITE	RONDELLE PLATE BANDE LARGE E=3D DIN 9021 HV100 D 10 X 30 X 2,5 Z.BLANCHE	FLACHE UNTERLEGSCHLEIBE DIN 9021 HV100 3D = D 10 X 30 X 2.5 Z WEIß	ARANDELA DE BANDA ANCHA DIN 9021 HV100 D 10 X 30 X 2,5 GALVANIZADA BLANCA
BR9	BR000900	NR	ROSETTA PIANA FASCIA LARGA E=3D DIN 9021 HV100 D 12 X 36 X 2,5 Z.BIANCA	WIDE BAND AND FLAT WASHER DIN 9021 HV100 3D = D 12 X 36 X 2.5 Z WHITE	RONDELLE PLATE LARGE BANDE =3D DIN 9021 HV100 D 12 X 36 X 2,5 GALVANISÉE BLANCHE	SCHEIBE	ARANDELA
BR10	BR001000	NR	RONDELLA X CARPENTERIA DIN 6916 HV 300 D 16 Z.BIANCA	CARPENTRY WASHER DIN 6916 HV 300 D 16 Z WHITE	RONDELLE POUR CHARPENTERIE DIN 6916 HV 300 D 16 Z.BLANCHE	ZIMMEREI UNTERLEGSCHLEIBE DIN 6916 HV 300 D 16 Z WEIß	ARANDELA DE CARPINTERÍA DIN 6916 HV 300 D 16 GALVANIZADA BLANCA
BR11	BR001100	NR	ROSETTE SPECIALI HV100 D 25 X 51 X 1 Z.BIANCA	SPECIAL WASHERS HV100 D 25 X 51 X 1 Z. WHITE	RONDELLES SPÉCIALES HV100 D 25 X 51 X 1 GALVANISATION BLANCHE	SCHEIBE	ARANDELA
BR13	BR001300	NR	RONDELLA DENTELLATURA ESTERNA DIN 6798-A ACC.MOLLE D 3 Z.D.BIANCA	WASHER EXTERNAL SERRATION DIN 6798-A ACC.MOLLE D 3 ZD WHITE	RONDELLE À DENTURE EXTÉRIEURE DIN 6798-A ACC.MOLLE D 3 Z.D GALVANISATION BLANCHE	SCHEIBE	ARANDELA
BR14	BR001400	NR	ROSETTA PIANA FASCIA LARGA E=3D DIN 9021 HV100 D 5 X 15 X 1,2 Z.BIANCA	WIDE BAND AND FLAT WASHER DIN 9021 HV100 3D = D 5 X 15 X 1.2 Z WHIT	RONDELLE PLATE BANDE LARGE E=3D DIN 9021 HV100 D 5 X 15 X 1,2 Z.BLANCHE	UNTERLEGSCHLEIBE DIN 9021 HV100 3D = D 5 X 15 X 1.2 Z WEIß	ARANDELA PLANA CINTA LUNGA DIN 9021 HV100 D 5 X 15 X 1,2 GALVANIZADA BLANCA



POS	Codice	U.M.	 Descrizione	 Description	 Designation	 Benennung	 Descripción
BR15	BR001500	NR	ROSETTA PIANA FASCIA LARGA E=3D DIN 9021 HV100 D 6 X 18 X 1,5 Z.BIANCA	WIDE BAND AND FLAT WASHER DIN 9021 HV100 3D = D 6 X 18 X 1.5 Z WHITE	RONDELLE PLATE BANDE LARGE E=3D DIN 9021 HV100 D 6 X 18 X 1,5 Z.BLANCHE	UNTERLEGSSCHEIBE DIN 9021 HV100 3D = D 6 X 18 X 1.5 Z WEIß	ARANDELA PLANA CINTA LUNGA E=3D DIN 9021 HV100 D 6 X 18 X 1,5 GALVANIZADA BLANCA
BR16	BR001600	NR	ROSETTA PIANA FASCIA LARGA E=3D DIN 9021 HV100 D 8 X 24 X 2 Z.BIANCA	WIDE BAND AND FLAT WASHER DIN 9021 HV100 3D = D 8 X 24 X 2 Z. WHITE	RONDELLE PLATE BANDE LARGE E=3D DIN 9021 HV100 D 8 X 24 X 2 Z.BLANCHE	UNTERLEGSSCHEIBE DIN 9021 HV100 3D = D 8 X 24 X 2 Z. WEIß	ARANDELA PLANA CINTA LUNGA E=3D DIN 9021 HV100 D 8 X 24 X 2 GALVANIZADA BLANCA
BR17	BR001700	NR	ROSETTA PIANA FASCIA LARGA E=3D DIN 9021 HV100 D 4 X 12 X 1 Z.BIANCA	WIDE BAND AND FLAT WASHER DIN 9021 HV100 D = 3D 4 X 12 X 1 Z. WHITE	RONDELLE PLASTE BANDE LARGEDIN 9021 HV100 D 4 X 12 X 1 GALVANISATION BLANCHE	SCHEIBE	ARANDELA
BR18	BR001800	NR	RONDELLA PIANA DIN 125-A NYLON D 4	PLAIN WASHER DIN 125-A NYLON D 4	RONDELLE PLATE DIN 125-A NYLON D 4	SCHEIBE	ARANDELA
BR19	BR001900	NR	RONDELLA PIANA DIN 125-A HV100 D 3 Z.BIANCA	PLAIN WASHER DIN 125-A HV100 D 3 Z. WHITE	RONDELLE PLATE DIN 125-A HV100 D 3 GALVANISATION BLANCHE	SCHEIBE	ARANDELA
BR20	BR002000	NR	RONDELLA PIANA DIN 125-A HV100 D 16 Z.BIANCA	PLAIN WASHER DIN 125-A HV100 D 16 Z. WHITE	RONDELLE PLATE DIN 125-A HV100 D 16 GALVANISATION BLANCHE	SCHEIBE	ARANDELA
BR21	BR002100	NR	ROSETTA PIANA FASCIA LARGA E=3D DIN 9021 HV100 D 16 X 48 X 4 Z.BIANCA	WIDE BAND AND FLAT WASHER DIN 9021 HV100 3D = D 16 X 48 X 4 Z. WHITE	RONDELLE PLATE BANDE LARGE E=3D DIN 9021 HV100 D 16 X 48 X 4 GALVANISÉE BLANCHE	FLACHE UNTERLEGSSCHEIBE DIN 9021 HV100 3D = D 16 X 48 X 4 Z. WEIß	ARANDELA PLANA BANDA ANCHA DIN 9021 HV100 D 16 X 48 X 4 GALVANIZADA BLANCA
BR22	BR002200	NR	GROWER SEZ.RETT.SPIGOLI VIVI PESANTE UNI 9195 ACC.MOLLE D 8 Z.D.BIANCA	GROWER SECTION. RECT. SHARP HEAVY UNI 9195 STAINLESS SPRINGS D 8 Z.D. WHITE	RONDELLE GROWER SECT. RECT. ARÊTES AIGUËS D 8 Z.D. BLANC	GROWER UNTERLEGSSCHEIBE - WEIß	ARANDELA GROWER SECT. RECT. ÁNGULOS VIVOS UNI 9195 GALVANIZADA BLANCA
BR23	BR002300	NR	ROSETTA PIANA FASCIA LARGA E=3D DIN 9021 HV100 D 3 X 12 X 1 Z.BIANCA	WIDE BAND AND FLAT WASHER DIN 9021 HV100 D = 3D 3 X 12 X 1 Z. WHITE	RONDELLE PLATE BANDE LARGE DIN 9021 HV100 D 3 X 12 X 1 GALVANISATION BLANCHE	SCHEIBE	ARANDELA
BR24	BR002400	NR	ROSETTA PIANA FASCIA LARGA E=3D DIN 9021 HV100 D 14 X 42 X 3 Z.BIANCA	WIDE BAND AND FLAT WASHER DIN 9021 HV100 D = 3D 14 X 42 X 3 Z. WHITE	RONDELLE PLATE BANDE LARGE DIN 9021 HV100 D 14 X 42 X 3 GALVANISATION BLANCHE	SCHEIBE	ARANDELA

POS	Codice	U.M.	 Descrizione	 Description	 Designation	 Benennung	 Descripción
BR25	BR002500	NR	GROWER SEZ.RETT.SPIGOLI VIVI PESANTE UNI 9195 ACC.MOLLE D 10 Z.D.BIANCA	GROWER SEZ.RETT. SHARP HEAVY UNI 9195 ACC.MOLLE D 10 Z.D. WHITE	RONDELLE GROWER SECT. RECT. ARÊTES AIGUËS UNI 9195 D 10 Z.D. BLANC	GROWER UNTERLEGSCHIEBE - WEIß	ARANDELA GROWER SECT. RECT. ÁNGULOS VIVOS UNI 9195 GALVANIZADA BLANCA
BR26	BR002600	NR	RONDELLA PIANA DIN 125-A D 30 Z.BIANCA	PLAIN WASHER DIN 125-A D 30 Z. WHITE	RONDELLE PLATE DIN 125-A D 30 GALVANISATION BLANCHE	SCHEIBE	ARANDELA
BR27	BR002700	NR	RONDELLA PIANA DIN 125-A HV100 D 14 Z.BIANCA	PLAIN WASHER DIN 125-A HV100 D 14 Z. WHITE	RONDELLE PLATE DIN 125-A HV100 D 14 Z.BLANCHE	FLACHE UNTERLEGSCHIEBE DIN 125-A HV100 D 14 Z. - WEIß	ARANDELA PLANA DIN 125-A HV100 D 14 GALVANIZADA BLANCA
BR28	BR002800	NR	ROSETTA PIANA FASCIA LARGA D 6 X 24 X 2 Z.BIANCA	WIDE BAND AND FLAT WASHER D 6 X 24 X 2 Z WHITE	RONDELLE PLATE BANDE LARGE D 6 X 24 X 2 Z BLANCHE	UNTERLEGSCHIEBE D 6 X 24 X 2 Z - WEIß	ARANDELA PLANA CINTA LUNGA D 6 X 24 X 2 GALVANIZADA BLANCA
BR29	BR002900	NR	RONDELLA PIANA DIN 125-A HV100 D 18 Z.BIANCA	PLAIN WASHER DIN 125-A HV100 D 18 Z. WHITE	RONDELLE PLATE DIN 125-A HV100 D 18 Z. BLANC	FLACHE UNTERLEGSCHIEBE DIN 125-A HV100 D 18 Z. WEIß	ARANDELA PLANA DIN 125-A HV100 D 18 GALVANIZADA BLANCA
BR30	BR003000	NR	RONDELLA PIANA DIN 125-A HV100 D 20 Z.BIANCA	PLAIN WASHER DIN 125-A HV100 D 20 Z. WHITE	RONDELLE PLATE DIN 125-A HV100 D 20 GALVANISÉE BLANCHE	FLACHE UNTERLEGSCHIEBE DIN 125-A HV100 D 20 Z. WEIß	ARANDELA PLANA DIN 125-A HV100 D 20 GALVANIZADA BLANCA
BR31	BR003100	NR	GROWER SEZ.RETT.SPIGOLI VIVI PESANTE UNI 9195 ACC.MOLLE D 12 Z.D.BIANCA	GROWER SEZ.RETT. SHARP HEAVY UNI 9195 ACC.MOLLE D 12 Z.D. WHITE	RONDELLE GROWER SECT. RECT. ARÊTE AIGUË UNI 9195 ACC.MOLLE D 12 Z.D.BLANC	GROWER UNTERLEGSCHIEBE UNI 9195 ACC.MOLLE D 12 Z.D. WEIß	ARANDELA GROWER SECT. RECT. ÁNGULOS VIVOS UNI 9195 D 12 GALVANIZADA BLANCA
BR32	BR003200	NR	ROSETTE SPECIALI HV100 D 30 X 42 X 0.5 Z.BIANCA	SPECIAL WASHERS HV100 D 30 X 42 X 0.5 Z. WHITE	RONDELLES SPÉCIALES HV100 D 30 X 42 X 0.5 GALVANISATION BLANCHE	SCHEIBE	ARANDELA
BR33	BR003300	NR	ROSETTE SPECIALI HV100 D 30 X 61 X 1 Z.BIANCA	SPECIAL WASHERS HV100 D 30 X 61 X 1 Z. WHITE	RONDELLES SPÉCIALES HV100 D 30 X 61 X 1 GALVANISATION BLANCHE	SCHEIBE	ARANDELA
BR34	BR003400	NR	ROSETTE SPECIALI HV100 D 42 X 52 X 0.2 Z.BIANCA	SPECIAL WASHERS HV100 D 42 X 52 X 0.2 Z. WHITE	RONDELLES SPÉCIALES HV100 D 42 X 52 X 0.2 GALVANISATION BLANCHE	SCHEIBE	ARANDELA
BR35	BR003500	NR	ROSETTE SPECIALI HV100 D 42 X 52 X 0.3 Z.BIANCA	SPECIAL WASHERS HV100 D 42 X 52 X 0.3 Z. WHITE	RONDELLES SPÉCIALES HV100 D 42 X 52 X 0.3 GALVANISATION BLANCHE	SCHEIBE	ARANDELA







Viteria







Fasteners



POS	Codice	U.M.	Descrizione	Description	Designation	Benennung	Descripción
BR36	BR003600	NR	ROSETTE SPECIALI HV100 D 42 X 52 X 1 Z.BIANCA	SPECIAL WASHERS HV100 D 42 X 52 X 1 Z. WHITE	RONDELLES SPÉCIALES HV100 D 42 X 52 X 1 GALVANISATION BLANCHE	SCHEIBE	ARANDELA
BR37	BR003700	NR	ROSETTE SPECIALI HV100 D 42 X 52 X 1.5 Z.BIANCA	SPECIAL WASHERS HV100 D 42 X 52 X 1.5 Z. WHITE	RONDELLES SPÉCIALES HV100 D 42 X 52 X 1.5 GALVANISATION BLANCHE	SCHEIBE	ARANDELA
BR38	BR003800	NR	ROSETTE SPECIALI HV100 D 42 X 52 X 2 Z.BIANCA	SPECIAL WASHERS HV100 D 42 X 52 X 2 Z. WHITE	RONDELLES SPÉCIALES HV100 D 42 X 52 X 2 GALVANISATION BLANCHE	SCHEIBE	ARANDELA
BR39	BR003900	NR	ROSETTA PIANA FASCIA LARGA E=3D DIN 9021 HV100 D 18 X 48 X 4 Z.BIANCA	WIDE BAND AND FLAT WASHER DIN 9021 HV100 3D = D 18 X 48 X 4 Z. WHITE	RONDELLE PLATE BANDE LARGE E=3D DIN 9021 HV100 D 18 X 48 X 4 GALVANISÉE BLANCHE	FLACHE UNTERLEGSCHIEBE DIN 9021 HV100 3D = D 18 X 48 X 4 Z. WEIß	ARANDELA PLANA BANDA ANCHA DIN 9021 HV100 D 18 X 48 X 4 GALVANIZADA BLANCA
BR40	BR004000	NR	ROSETTA SCHNORR ZINCATE D 6	WASHER	RONDELLE	SCHEIBE	ARANDELA
BR41	BR004100	NR	GROWER SEZ.RETT.SPIGOLI VIVI PESANTE UNI 9195 ACC.MOLLE D 14 Z.D.BIANCA	GROWER SEZ.RETT. SHARP HEAVY UNI 9195 ACC.MOLLE D 14 Z.D. WHITE	RONDELLE GROWER SECT. RECT. ARÊTE AIGUË UNI 9195 ACC.MOLLE D 14 Z.D.BLANC	GROWER UNTERLEGSCHIEBE UNI 9195 ACC.MOLLE D 14 Z.D. WEIß	ARANDELA GROWER SECT. RECT. ÁNGULOS VIVOS UNI 9195 D 14 GALVANIZADA BLANCA
BR42	BR004200	NR	RONDELLA X CARPENTERIA DIN 6916 HV 300 D 14 Z.BIANCA	CARPENTRY WASHER DIN 6916 HV 300 D 14 Z WHITE	RONDELLE POUR CHARPENTERIE DIN 6916 HV 300 D 14 Z.BLANCHE	ZIMMEREI UNTERLEGSCHIEBE DIN 6916 HV 300 D 14 Z WEIß	ARANDELA DE CARPINTERÍA DIN 6916 HV 300 D 14 GALVANIZADA BLANCA
BR43	BR004300	NR	RONDELLA X CARPENTERIA DIN 125-A HV 300 D 10 Z.BIANCA	CARPENTRY WASHER DIN 125-A HV 300 D 10 Z WHITE	RONDELLE POUR CHARPENTERIE DIN 125-A HV 300 D 10 Z.BLANCHE	ZIMMEREI UNTERLEGSCHIEBE DIN 125-A HV 300 D 10 Z WEIß	ARANDELA DE CARPINTERÍA DIN 125-A HV 300 D 10 GALVANIZADA BLANCA
BR44	BR004400	NR	RONDELLA X CARPENTERIA DIN 125-A HV 300 D 20 Z.BIANCA	CARPENTRY WASHER DIN 125-A HV 300 D 20 Z WHITE	RONDELLE POUR CHARPENTERIE DIN 125-A HV 300 D 20 Z.BLANCHE	ZIMMEREI UNTERLEGSCHIEBE DIN 125-A HV 300 D 20 Z WEIß	ARANDELA DE CARPINTERÍA DIN 125-A HV 300 D 20 GALVANIZADA BLANCA
BR45	BR004500	NR	RONDELLA PIANA DIN 125-A HV200 D 10 Z.BIANCA	PLAIN WASHER DIN 125-A HV200 D 10 Z. WHITE	RONDELLE POUR CHARPENTERIE	ZIMMEREI UNTERLEGSCHIEBE	ARANDELA DE CARPINTERÍA
BR48	BR004800	NR	RONDELLA PIANA DIN 125-A HV100 D 22 Z.BIANCA	PLAIN WASHER DIN 125-A HV100 D 22 Z. WHITE	RONDELLE POUR CHARPENTERIE	ZIMMEREI UNTERLEGSCHIEBE	ARANDELA DE CARPINTERÍA





POS	Codice	U.M.	 Descrizione	 Description	 Designation	 Benennung	 Descripción
BR49	BR004900	NR	ROSETTA PIANA FASCIA LARGA E=4D DIN 9021 HV100 D 12 X 48 X 2,5 Z.BIANCA	WASHER FLAT AND WIDE BAND E = 4D DIN 9021 HV100 D 12 X 48 X 2.5 Z. WHITE	RONDELLE POUR CHARPENTERIE	ZIMMEREI UNTERLEGSCHIEBE	ARANDELA DE CARPINTERÍA
BR50	BR005000	NR	ROSETTA PIANA FASCIA LARGA E=3D DIN 9021 HV100 D 20 X 60 X 4 Z.BIANCA	WASHER FLAT AND WIDE BAND E = 3D DIN 9021 HV100 D 20 X 60 X 4 Z. WHITE	RONDELLE POUR CHARPENTERIE	ZIMMEREI UNTERLEGSCHIEBE	ARANDELA DE CARPINTERÍA
BR53	BR005300	NR	RONDELLE ELASTICHE GROWER DIN 127-B ACC.MOLLE D 6 Z.D.BIANCA	ELASTIC WASHERS GROWER DIN 127-B ACC. SPRINGS D 6 Z.D. WHITE	RONDELLE POUR CHARPENTERIE	ZIMMEREI UNTERLEGSCHIEBE	ARANDELA DE CARPINTERÍA
BR54	BR005400	NR	ROSETTA DI SICUREZZA TIPO SCHNORR TIPO S INOX D 6	WASHER SCHNORR TYPE S INOX D 6 SECURITY	RONDELLE POUR CHARPENTERIE	ZIMMEREI UNTERLEGSCHIEBE	ARANDELA DE CARPINTERÍA
BR55	BR005500	NR	RONDELLA DENTELLATURA ESTERNA DIN 6798-A ACC.MOLLE D 5 Z.D.BIANCA	WASHER EXTERNAL SERRATION DIN 6798-A ACC. SPRINGS D 5 Z.D. WHITE	RONDELLE POUR CHARPENTERIE	ZIMMEREI UNTERLEGSCHIEBE	ARANDELA DE CARPINTERÍA
BR56	BR005600	NR	RONDELLA X CARPENTERIA DIN 6916 HV 300 D 12 Z.BIANCA	WASHER DIN 6916 HV 300 D 12 Z. WHITE	RONDELLE POUR CHARPENTERIE	ZIMMEREI UNTERLEGSCHIEBE	ARANDELA DE CARPINTERÍA
BR57	BR005700	NR	ROSETTE SPECIALI HV100 D 36 X 65 X 1 Z.BIANCA	SPECIAL WASHERS HV100 D 36 X 65 X 1 Z. WHITE	RONDELLES SPÉCIALES HV100 D 36 X 65 X 1 GALVANISATION BLANCHE	SCHEIBE	ARANDELA
BR58	BR005800	NR	ROSETTE SPECIALI HV100 D 50 X 60 X 1 Z.BIANCA	SPECIAL WASHERS HV100 D 50 X 60 X 1 Z. WHITE	RONDELLES SPÉCIALES HV100 D 50 X 60 X 1 GALVANISATION BLANCHE	SCHEIBE	ARANDELA
BR59	BR005900	NR	ROSETTE SPECIALI HV300 D 20 X 54 X 3 Z.BIANCA	SPECIAL WASHERS HV300 D 20 X 54 X 3 Z. WHITE	RONDELLES SPÉCIALES HV300 D 20 X 54 X 3 GALVANISATION BLANCHE	SCHEIBE HV300 D 20 X 54 X 3	ARANDELA HV300 D 20 X 54 X 3 Z.
BR60	BR006000	NR	RONDELLA PIANA DIN 125-A NYLON D 12	PLAIN WASHER DIN 125-A NYLON D 12	RONDELLE PLATE DIN 125-A NYLON D 12	SCHEIBE	ARANDELA
BR61	BR006100	NR	RONDELLA PIANA DIN 125-A INOX A2 D4	PLAIN WASHER DIN 125-A INOX A2 D4	RONDELLE POUR CHARPENTERIE	ZIMMEREI UNTERLEGSCHIEBE	ARANDELA DE CARPINTERÍA
BR62	BR006200	NR	RONDELLA PIANA DIN 125-A HV300 D 20 Z.BIANCA	PLAIN WASHER DIN 125-A HV300 D 20 Z. WHITE	RONDELLE POUR CHARPENTERIE	ZIMMEREI UNTERLEGSCHIEBE	ARANDELA DE CARPINTERÍA
BR63	BR006300	NR	RONDELLA ANTIROTAZIONE DIN463 HV100 D6.4 X M6	WASHER DIN463 HV100 D6.4 X M6	RONDELLE POUR CHARPENTERIE	ZIMMEREI UNTERLEGSCHIEBE	ARANDELA DE CARPINTERÍA





POS	Codice	U.M.	 Descrizione	 Description	 Designation	 Benennung	 Descripción
BS1	BS000100	NR	GRANO FILETTATO M6X12	SCREW	VIS	SCHRAUBE	TORNILLO
BS2	BS000200	NR	SPINA CIL. 8X16 UNI 6364-A H6 CMT + TMP	PIN CYLINDER 8 X 16 UNI 6364-A CMT H6 + TMP			
BS3	BS000300	NR	PRIGIONIERO M10X35	PIN	AXE	GEWINDESTIFT	CLAVIJA
BS4	BS000400	NR	SPINA ELASTICA 6X60 UNI 6873	PIN	AXE	STIFT	CLAVIJA
BS5	BS000500	NR	SPINA ELASTICA 6X14 UNI 6873	PIN	AXE	STIFT	CLAVIJA
BS6	BS000600	NR	SPINA SPIROL NORMALE DIN 7343 INOX A2 D 5X10	PIN	AXE	STIFT	CLAVIJA
BS7	BS000700	NR	RIVETTO ALLUMINIO Ø3X12	ALUMINUM RIVET Ø3X12			
BS8	BS000800	NR	MOLLA COMPRESSIONE INOX AISI 302 D10.668 S1.066 L31.75	SPRING COMPRESSION AISI 302 D10.668 S1.066 L31.75			
BS13	BS001300	NR	SPINA ELASTICA DIN 1481 ACC.MOLLE D 8 X 50	ELASTIC PIN DIN 1481 ACC SPRINGS D 8 X 50			
BS14	BS001400	NR	SPINA SPIROL NORMALE DIN 7343 ACC.MOLLE D 5 X 10	PIN SPIROL NORMAL DIN 7343 ACC. SPRINGS D 5 X 10			
BS15	BS001500	NR	RIVETTI A STRAPPO TB AL/AC DIN 7337 D 3,2 X 12	BLIND RIVETS TB AL / AC DIN 7337 D 3.2 X 12			
BS16	BS001600	NR	RIVETTI A STRAPPO TB AL/AC DIN 7337 D 4,8 X 12	BLIND RIVETS TB AL / AC DIN 7337 D 4.8 X 12			
BS17	BS001700	NR	RIVETTI A STRAPPO TB A2/A2 DIN 7337 D 4,8 X 12	BLIND RIVETS TB A2 / A2 DIN 7337 D 4.8 X 12			
BS21	BS002100	NR	RIVETTO ALLUMINIO Ø4X10	ALUMINUM RIVET Ø4X10			
BS22	BS002200	NR	PRIGIONIERO M10X80	PIN M10X80	AXE M10X80	GEWINDESTIFT M10X80	CLAVIJA M10X80
BV1	BV000100	NR	VITE TE PARZIALE FILETTO PG DIN 931 CL 8.8 M 8 X 80 Z.BIANCA	SCREW PARTIAL THREAD DIN 931 PG CL 8.8 M 8 X 80 Z. WHITE	VIS PARTIELLEMENT FILETÉE DIN 931 CL 8.8 M 8 X 80 GALVANISATION BLANCHE	SCHRAUBE	TORNILLO
BV2	BV000200	NR	VITE TE TUTTO FILETTO PG DIN 933 CL 8.8 M 8 X 60 Z.BIANCA	SCREW ALL THREAD DIN 933 PG CL 8.8 M 8 X 60 Z. WHITE	VIS ENTIEREMENT FILETÉE DIN 933 CL 8.8 M 8 X 60 GALVANISATION BLANCHE	SCHRAUBE	TORNILLO





POS	Codice	U.M.	 Descrizione	 Description	 Designation	 Benennung	 Descripción
BV3	BV000300	NR	VITE TCEI PG DIN 912 CL 8.8 M 8 X 60 Z.BIANCA	SCREW DIN 912 PG CL 8.8 M8 X 60 Z. WHITE	VIS DIN 912 CL 8.8 M 8 X 60 GALVANISATION BLANCHE	SCHRAUBE	TORNILLO
BV4	BV000400	NR	VITE TE PARZIALE FILETTO PG DIN 931 CL 8.8 M 8 X 50 Z.BIANCA	SCREW PARTIAL THREAD DIN 931 PG CL 8.8 M 8 X 50 Z. WHITE	VIS PARTIELLEMENT FILETÉE BLANC	TEILGEWINDESCHRAUBE DIN 931 PG CL 8.8 M 8 X 50 Z. WEIß	TORNILLO PARCIALMENTE ROSCADO PG DIN 931 CL 8.8 M 8 X 50 GALVANIZADO BLANCO
BV5	BV000500	NR	VITE TCEI PG DIN 912 CL 8.8 M 8 X 45 Z.BIANCA	SCREW DIN 912 PG CL 8.8 M8 X 45 Z. WHITE	VIS DIN 912 CL 8.8 M 8 X 45 GALVANISATION BLANCHE	SCHRAUBE	TORNILLOL
BV6	BV000600	NR	VITE TCEI PG DIN 912 CL 8.8 M 8 X 40 Z.BIANCA	SCREW DIN 912 PG CL 8.8 M8 X 40 Z.BIANCA	VIS DIN 912 CL 8.8 M 8 X 40 GALVANISATION BLANCHE	SCHRAUBE	TORNILLO
BV7	BV000700	NR	VITE TE TUTTO FILETTO PG DIN 933 CL 8.8 M 8 X 35 Z.BIANCA	SCREW ALL THREAD DIN 933 PG CL 8.8 M 8 X 35 Z. WHITE	VIS TE ENTIÈREMENT FILETÉE DIN 933 PG CL 8.8 M 8 X 35 Z. BLANC	VOLLGEWINDESCHRAUBE DIN 933 PG CL 8.8 M 8 X 35 Z. WEIß	TORNILLO TOTALMENTE ROSCADO PG DIN 933 CL 8.8 M 8 X 35 GALVANIZADO BLANCO
BV8	BV000800	NR	VITE TE TUTTO FILETTO PG DIN 933 CL 8.8 M 8 X 30 Z.BIANCA	SCREW ALL THREAD DIN 933 PG CL 8.8 M 8 X 30 Z. WHITE	VIS TE ENTIÈREMENT FILETÉE DIN 933 PG CL 8.8 M 8 X 30 Z. BLANC	VOLLGEWINDESCHRAUBE DIN 933 PG CL 8.8 M 8 X 30 Z. WEIß	TORNILLO TOTALMENTE ROSCADO PG DIN 933 CL 8.8 M 8 X 30 GALVANIZADO BLANCO
BV9	BV000900	NR	VITE TE TUTTO FILETTO PG DIN 933 CL 8.8 M 8 X 25 Z.BIANCA	SCREW ALL THREAD DIN 933 PG CL 8.8 M 8 X 25 Z. WHITE	VIS TE ENTIÈREMENT FILETÉE PG DIN 933 CL 8.8 M 8 X 25 Z.BLANC	VOLLGEWINDESCHRAUBE DIN 933 PG CL 8.8 M 8 X 25 Z. WEIß	TORNILLO TOTALMENTE ROSCADO PG DIN 933 CL 8.8 M 8 X 25 GALVANIZADO BLANCO
BV10	BV001000	NR	VITE TCEI PG DIN 912 CL 8.8 M 8 X 25 Z.BIANCA	SCREW DIN 912 PG CL 8.8 M8 X 25 Z. WHITE	VIS TCEI PG DIN 912 CL 8.8 M 8 X 25 Z.BLANC	SCHRAUBE DIN 912 PG CL 8.8 M8 X 25 Z. WEIß	TORNILLO TCEI PG DIN 912 CL 8.8 M 8 X 25 GALVANIZADO BLANCO
BV11	BV001100	NR	VITE TE TUTTO FILETTO PG DIN 933 CL 8.8 M 8 X 20 Z.BIANCA	SCREW ALL THREAD DIN 933 PG CL 8.8 M 8 X 20 Z. WHITE	VIS TE ENTIÈREMENT FILETÉE PG DIN 933 CL 8.8 M 8 X 20 Z.BLANC	VOLLGEWINDESCHRAUBE DIN 933 PG CL 8.8 M 8 X 20 Z. WEIß	TORNILLO TOTALMENTE ROSCADO PG DIN 933 CL 8.8 M 8 X 20 GALVANIZADO BLANCO
BV12	BV001200	NR	VITE TE TUTTO FILETTO PG DIN 933 CL 8.8 M 8 X 16 Z.BIANCA	SCREW ALL THREAD DIN 933 PG CL 8.8 M 8 X 16 Z. WHITE	VIS TE ENTIÈREMENT FILETÉE PG DIN 933 CL 8.8 M 8 X 16 Z.BLANC	VOLLGEWINDESCHREUBE DIN 933 PG CL 8.8 M 8 X 16 Z. WEIß	TORNILLO TOTALMENTE ROSCADO PG DIN 933 CL 8.8 M 8 X 16 GALVANIZADO BLANCO
BV13	BV001300	NR	VITE TCEI PG DIN 912 CL 8.8 M 8 X 16 Z.BIANCA	SCREW DIN 912 PG CL 8.8 M8 X 16 Z. WHITE	VIS TCEI PG DIN 912 CL 8.8 M 8 X 16 GALVANISÉE BLANCHE	SCHRAUBE DIN 912 PG CL 8.8 M8 X 16 Z. WEIß	TORNILLO DIN 912 CL 8.8 M 8 X 16 GALVANIZADO BLANCO
BV14	BV001400	NR	VITE TE TUTTO FILETTO PG DIN 933 CL 8.8 M 8 X 14 Z.BIANCA	SCREW ALL THREAD DIN 933 PG CL 8.8 M 8 X 14 Z. WHITE	VIS ENTIÈREMENT FILETÉE DIN 933 CL 8.8 M 8 X 14 GALVANISATION BLANCHE	SCHRAUBE	TORNILLO

POS	Codice	U.M.	 Descrizione	 Description	 Designation	 Benennung	 Descripción
BV15	BV001500	NR	VITE TCEI PG DIN 912 CL 8.8 M 6 X 45 Z.BIANCA	SCREW DIN 912 M6 X 45 CL 8.8 Z. WHITE	VIS DIN 912 CL 8.8 M 6 X 45 GALVANISATION BLANCHE	SCHRAUBE	TORNILLO
BV16	BV001600	NR	VITE TCEI PG DIN 912 CL 8.8 M 6 X 30 Z.BIANCA	SCREW DIN 912 M6 X 30 CL 8.8 Z. WHITE	VIS TCEI PG DIN 912 CL 8.8 M 6 X 30 Z.BLANC	SCHRAUBE DIN 912 M6 X 30 CL 8.8 Z. WEIß	TORNILLO TCEI PG DIN 912 CL 8.8 M 6 X 30 GALVANIZADO BLANCO
BV17	BV001700	NR	VITE TSPEI PG DIN 7991 CL 10.9 M 6 X 30 Z.BIANCA	SCREW DIN 7991 CL 10.9 M 6 X 30 Z. WHITE	VIS DIN 7991 CL 10.9 M 6 X 30 GALVANISATION BLANCHE	SCHRAUBE	TORNILLO
BV18	BV001800	NR	VITE TE TUTTO FILETTO PG DIN 933 CL 8.8 M 6 X 30 Z.BIANCA	SCREW ALL THREAD DIN 933 PG CL 8.8 M 6 X 30 Z. WHITE	VIS ENTIÈREMENT FILETÉE DIN 933 CL 8.8 M 6 X 30 GALVANISÉE BLANCHE	VOLLGEWINDESCHRAUBE DIN 933 PG CL 8.8 M 6 X 30 Z. WEIß	TORNILLO TOTALMENTE ROSCADO DIN 933 CL 8.8 M 6 X 30 GALVANIZADO BLANCO
BV19	BV001900	NR	VITE TBEI PG ISO 7380 CL 10.9 M 6 X 30 Z.BIANCA	SCREW ISO 7380 CL 10.9 M 6 X 30 Z. WHITE	VIS ISO 7380 CL 10.9 M 6 X 30 GALVANISATION BLANCHE	SCHRAUBE	TORNILLO
BV20	BV002000	NR	VITE TE TUTTO FILETTO PG DIN 933 CL 8.8 M 6 X 12 Z.BIANCA	SCREW ALL THREAD DIN 933 PG CL 8.8 M 6 X 12 Z. WHITE	VIS TE ENTIÈREMENT FILETÉE PG DIN 933 CL 8.8 M 6 X 12 Z.BIANCA	VOLLGEWINDESCHRAUBE DIN 933 PG CL 8.8 M 6 X 12 Z. WEIß	TORNILLO TOTALMENTE ROSCADO PG DIN 933 CL 8.8 M 6 X 12 GALVANIZADO BLANCO
BV21	BV002100	NR	VITE TCEI PG DIN 912 CL 8.8 M 6 X 12 Z.BIANCA	SCREW DIN 912 PG CL 8.8 M 6 X 12 Z. WHITE	VIS DIN 912 CL 8.8 M 6 X 12 GALVANISATION BLANCHE	SCHRAUBE	TORNILLO
BV22	BV002200	NR	VITE TCEI PG DIN 912 CL 8.8 M 5 X 45 Z.BIANCA	SCREW DIN 912 PG CL 8.8 M 5 X 45 Z. WHITE	VIS DIN 912 CL 8.8 M 5 X 45 GALVANISATION BLANCHE	SCHRAUBE	TORNILLO
BV23	BV002300	NR	VITE TE UNF ANSI B18.2.1 GR.5 5/16 X 1" Z.BIANCA	SCREW UNF ANSI B18.2.1 GR.5 5/16 X 1" Z. WHITE	VIS UNF ANSI B18.2.1 GR.5 5/16 X 1" GALVANISATION BLANCHE	SCHRAUBE	TORNILLO
BV24	BV002400	NR	VITE TC CROCE PG DIN 7985 CL 4.8 M 4 X 8 Z.BIANCA	CROSS HEAD SCREW DIN 7985 PG CL 4.8 M 4 X 8 Z. WHITE	VIS TC EN CROIX PG DIN 7985 CL 4.8 M 4 X 8 Z.BLANC	KREUZSCHLITZCHRAUBE DIN 7985 PG CL 4.8 M 4 X 8 Z. WEIß	TORNILLO TC DE CRUZ PG DIN 7985 CL 4.8 M 4 X 8 GALVANIZADO BLANCO
BV25	BV002500	NR	VITE TCEI PG DIN 912 CL 8.8 M 4 X 16 Z.BIANCA	SCREW DIN 912 PG CL 8.8 M 4 X 16 Z. WHITE	VIS DIN 912 CL 8.8 M 4 X 16 GALVANISATION BLANCHE	SCHRAUBE	TORNILLO
BV26	BV002600	NR	VITE TCEI PG DIN 912 CL 8.8 M 6 X 50 Z.BIANCA	SCREW DIN 912 PG CL 8.8 M 6 X 50 Z. WHITE	VIS DIN 912 CL 8.8 M 6 X 50 GALVANISATION BLANCHE	SCHRAUBE	TORNILLO
BV27	BV002700	NR	VITE TSPEI PG DIN 7991 CL 10.9 M 6 X 40 Z.BIANCA	SCREW DIN 7991 CL 10.9 M 6 X 40 Z. WHITE	VIS DIN 7991 CL 10.9 M 6 X 40 GALVANISÉE BLANCHE	SCHRAUBE DIN 7991 CL 10.9 M 6 X 40 Z. WEIß	TORNILLO DIN 7991 CL 10.9 M 6 X 40 GALVANIZADO BLANCO



POS	Codice	U.M.	 Descrizione	 Description	 Designation	 Benennung	 Descripción
BV28	BV002800	NR	VITE TSPEI PG DIN 7991 CL 10.9 M 6 X 25 Z.BIANCA	SCREW DIN 7991 CL 10.9 M 6 X 25 Z. WHITE	VIS TSPEI PG DIN 7991 CL 10.9 M 6 X 25 Z.BLANC	SCHRAUBE DIN 7991 CL 10.9 M 6 X 25 Z. WEIß	TORNILLO TSPEI PG DIN 7991 CL 10.9 M 6 X 25 GALVANIZADO BLANCO
BV29	BV002900	NR	VITE TE TUTTO FILETTO PG DIN 933 CL 8.8 M 6 X 25 Z.BIANCA	SCREW ALL THREAD DIN 933 PG CL 8.8 M 6 X 25 Z. WHITE	VIS TE ENTIÈREMENT FILETÉE PG DIN 933 CL 8.8 M 6 X 25 Z.BLANC	VOLLGEWINDESCHRAUBE DIN 933 PG CL 8.8 M 6 X 25 Z. WEIß	TORNILLO TOTALMENTE ROSCADO PG DIN 933 CL 8.8 M 6 X 25 GALVANIZADO BLANCO
BV30	BV003000	NR	VITE TE TUTTO FILETTO PG DIN 933 CL 8.8 M 6 X 22 Z.BIANCA	SCREW ALL THREAD DIN 933 PG CL 8.8 M 6 X 22 Z. WHITE	VIS TE ENTIÈREMENT FILETÉE PG DIN 933 CL 8.8 M 6 X 22 Z.BLANC	VOLLGEWINDESCHRAUBE DIN 933 PG CL 8.8 M 6 X 22 Z. WEIß	TORNILLO TE TOTALMENTE ROSCADO PG DIN 933 CL 8.8 M 6 X 22 GALVANIZADO BLANCO
BV31	BV003100	NR	VITE TSPEI PG DIN 7991 CL 10.9 M 6 X 20 Z.BIANCA	SCREW DIN 7991 CL 10.9 M 6 X 20 Z. WHITE	VIS TSPEI PG DIN 7991 CL 10.9 M 6 X 20 Z.BLANC	SCHRAUBE DIN 7991 CL 10.9 M 6 X 20 Z. WEIß	TORNILLO TSPEI PG DIN 7991 CL 10.9 M 6 X 20 GALVANIZADO BLANCO
BV32	BV003200	NR	VITE TE TUTTO FILETTO PG DIN 933 CL 8.8 M 6 X 20 Z.BIANCA	SCREW ALL THREAD DIN 933 PG CL 8.8 M 6 X 20 Z. WHITE	VIS TE ENTIÈREMENT FILETÉE PG DIN 933 CL 8.8 M 6 X 20 Z.BLANC	VOLLGEWINDESCHRAUBE DIN 933 PG CL 8.8 M 6 X 20 Z. WEIß	TORNILLO TOTALMENTE ROSCADO PG DIN 933 CL 8.8 M 6 X 20 GALVANIZADO BLANCO
BV33	BV003300	NR	VITE TCEI PG DIN 912 CL 8.8 M 6 X 20 Z.BIANCA	SCREW DIN 912 PG CL 8.8 M 6 X 20 Z. WHITE	VIS TCEI PG DIN 912 CL 8.8 M 6 X 20 Z.BLANC	SCHRAUBE DIN 912 PG CL 8.8 M 6 X 20 Z. WEIß	TORNILLO TCEI PG DIN 912 CL 8.8 M 6 X 20 GALVANIZADO BLANCO
BV34	BV003400	NR	VITE TE TUTTO FILETTO PG DIN 933 CL 8.8 M 6 X 16 Z.BIANCA	SCREW ALL THREAD DIN 933 PG CL 8.8 M 6 X 16 Z. WHITE	VIS TE ENTIÈREMENT FILETÉE G DIN 933 CL 8.8 M 6 X 16 Z.BLANC	VOLLGEWINDESCHRAUBE DIN 933 PG CL 8.8 M 6 X 16 Z. WEIß	TORNILLO TOTALMENTE ROSCADO PG DIN 933 CL 8.8 M 6 X 16 GALVANIZADO BLANCO
BV35	BV003500	NR	VITE TBEI PG ISO 7380 CL 10.9 M 6 X 16 Z.BIANCA	SCREW ISO 7380 CL 10.9 M 6 X 16 Z. WHITE	VIS TBEI PG ISO 7380 CL 10.9 M 6 X 16 Z.BLANC	SCHRAUBE ISO 7380 CL 10.9 M 6 X 16 Z. WEIß	TORNILLO TBEI PG ISO 7380 CL 10.9 M 6 X 16 GALVANIZADO BLANCO
BV36	BV003600	NR	VITE TCEI PG DIN 912 CL 8.8 M 5 X 8 Z.BIANCA	SCREW DIN 912 PG CL 8.8 M 5 X 8 Z. WHITE	VIS DIN 912 CL 8.8 M 5 X 8 GALVANISATION BLANCHE	SCHRAUBE	TORNILLO
BV37	BV003700	NR	VITE TSPEI PG DIN 7991 CL 10.9 M 5 X 60 Z.BIANCA	SCREW DIN 7991 CL 10.9 M 5 X 60 Z. WHITE	VIS DIN 7991 CL 10.9 M 5 X 60 GALVANISATION BLANCHE	SCHRAUBE	TORNILLO
BV38	BV003800	NR	VITE TE PARZIALE FILETTO PG DIN 931 CL 8.8 M 5 X 60 Z.BIANCA	SCREW PARTIAL THREAD DIN 931 PG CL 8.8 M 5 X 60 Z. WHITE	VIS PARTILLEMENT FILETÉE DIN 931 CL 8.8 M 5 X 60 GALVANISATION BLANCHE	SCHRAUBE	TORNILLO
BV39	BV003900	NR	VITE TCEI PG DIN 912 CL 8.8 M 5 X 60 Z.BIANCA	SCREW DIN 912 PG CL 8.8 M 5 X 60 Z. WHITE	VIS DIN 912 CL 8.8 M 5 X 60 GALVANISATION BLANCHE	SCHRAUBE	TORNILLO





POS	Codice	U.M.	 Descrizione	 Description	 Designation	 Benennung	 Descripción
BV40	BV004000	NR	VITE TE PARZIALE FILETTO PG DIN 931 CL 8.8 M 5 X 55 Z.BIANCA	SCREW PARTIAL THREAD DIN 931 PG CL 8.8 M 5 X 55 Z. WHITE	VIS PARTIELLEMENT FILETÉE DIN 931 CL 8.8 M 5 X 55 GALVANISATION BLANCHE	SCHRAUBE	TORNILLO
BV41	BV004100	NR	VITE TE TUTTO FILETTO PG DIN 933 CL 8.8 M 5 X 16 Z.BIANCA	SCREW ALL THREAD DIN 933 PG CL 8.8 M 5 X 16 Z. WHITE	VIS TE ENTIÈREMENT FILETÉE PG DIN 933 CL 8.8 M 5 X 16 Z.BLANC	VOLLGEWINDESCHRAUBE DIN 933 PG CL 8.8 M 5 X 16 Z. WEIß	TORNILLO TOTALMENTE ROSCADO PG DIN 933 CL 8.8 M 5 X 16 GALVANIZADO BLANCO
BV42	BV004200	NR	VITE TC CROCE PG DIN 7985 CL 4.8 M 5 X 16 Z.BIANCA	CROSS HEAD SCREW DIN 7985 PG CL 4.8 M 5 X 16 Z. WHITE	VIS TC EN CROIX PG DIN 7985 CL 4.8 M 5 X 16 Z.BLANC	KREUZSCHLITZSCHRAUBE DIN 7985 PG CL 4.8 M 5 X 16 Z. WEIß	TORNILLO TC DE CRUZ PG DIN 7985 CL 4.8 M 5 X 16 GALVANIZADO BLANCO
BV43	BV004300	NR	VITE TE TUTTO FILETTO PG DIN 933 CL 8.8 M 5 X 12 Z.BIANCA	SCREW ALL THREAD DIN 933 PG CL 8.8 M 5 X 12 Z. WHITE	VIS ENTIÈREMENT FILETÉE DIN 933 CL 8.8 M 5 X 12 GALVANISATION BLANCHE	SCHRAUBE	TORNILLO
BV44	BV004400	NR	VITE TE UNF ANSI B18.2.1 GR.5 5/16 X 1"1/4 Z.BIANCA	SCREW UNF ANSI B18.2.1 GR.5 5/16 X 1 "1/4 Z. WHITE	VIS UNF ANSI B18.2.1 GR.5 5/16 X 1"1/4 GALVANISATION BLANCHE	SCHRAUBE	TORNILLO
BV45	BV004500	NR	VITE TE UNF ANSI B18.2.1 GR.5 5/16 X 1"1/4 Z.BIANCA	SCREW UNF ANSI B18.2.1 GR.5 5/16 X 1 "1/4 Z. WHITE	VIS UNF ANSI B18.2.1 GR.5 5/16 X 1"1/4 GALVANISATION BLANCHE	SCHRAUBE	TORNILLO
BV46	BV004600	NR	VITE TCEI PG DIN 912 CL 8.8 M 4 X 40 Z.BIANCA	SCREW DIN 912 PG CL 8.8 M 4 X 40 Z. WHITE	VIS DIN 912 CL 8.8 M 4 X 40 GALVANISATION BLANCHE	SCHRAUBE	TORNILLO
BV47	BV004700	NR	VITE TRILOB. AUTOFORM. TC CROCE PG DIN 7500-C C15 M 4 X 40 Z.BIANCA	TRILOB SCREW. AUTOFORM. TC CROSS PH DIN 7500-C C 15 M 4 X 40 Z. WHITE	VIS TRILOB. AUTOFORM. TC CROIX PG DIN 7500-C C15 M 4 X 40 GALVANISATION BLANCHE	SCHRAUBE	TORNILLO
BV48	BV004800	NR	VITE TRILOB. AUTOFORM. TC CROCE PG DIN 7500-C C15 M 4 X 20 Z.BIANCA	TRILOB SCREW. AUTOFORM. TC CROSS PG DIN 7500-C C15 M 4 X 20 Z. WHITE	VIS TRILOB. AUTOFORM. TC CROIX PG DIN 7500-C C15 M 4 X 20 GALVANISATION BLANCHE	SCHRAUBE	TORNILLO
BV49	BV004900	NR	VITE TC CROCE PG DIN 7985 CL 4.8 M 4 X 16 Z.BIANCA	CROSS HEAD SCREW DIN 7985 PG CL 4.8 M 4 X 16 Z. WHITE	VIS TC CROIX DIN 7985 CL 4.8 M 4 X 16 GALVANISATION BLANCHE	SCHRAUBE	TORNILLO
BV50	BV005000	NR	VITE AUTOFILETTANTE TE C/BORDINO DIN 6928 C15 4,8X50 Z.BIANCA	TAPPING SCREW TE C / BORDINO DIN 6928 C15 4.8 X50 Z. WHITE	VIS AUTOFILETÉE TE C/BORDINO DIN 6928 C15 4,8X50 GALVANISATION BLANCHE	SCHRAUBE	TORNILLO





POS	Codice	U.M.	 Descrizione	 Description	 Designation	 Benennung	 Descripción
BV51	BV005100	NR	VITE AUTOFILETTANTE TE C/BORDINO DIN 6928 C15 4,8X25 Z.BIANCA	TAPPING SCREW TE C / BORDINO DIN 6928 C15 4.8 X25 Z. WHITE	VIS AUTOFILETÉE TE C/BORDINO DIN 6928 C15 4,8X25 GALVANISATION BLANCHE	SCHRAUBE	TORNILLO
BV52	BV005200	NR	VITE TCEI PG DIN 912 CL 12.9 M 3 X 25 Z.D.BIANCA	SCREW DIN 912 M 3 CL 12.9 X 25 Z.D. WHITE	VIS TCEI PG DIN 912 CL 12.9 M 3 X 25 GALVANISATION BLANCHE	SCHRAUBE	TORNILLO
BV53	BV005300	NR	VITE TSPEI PG DIN 7991 CL 10.9 M 3 X 14 Z.BIANCA	SCREW DIN 7991 CL 10.9 M 3 X 14 Z. WHITE	VIS DIN 7991 CL 10.9 M 3 X 14 GALVANISATION BLANCHE	SCHRAUBLE	TORNILLO
BV54	BV005400	NR	VITE AUTOFIL.TC CROCE DIN 7981 C15 3,5 X 6,5 Z.BIANCA	AUTOFIL.TC CROSS SCREW DIN 7981 C15 3.5 X 6.5 Z. WHITE	VIS AUTOFILETÉE CROIX DIN 7981 C15 3,5 X 6,5 GALVANISATION BLANCHE	SCHRAUBE	TORNILLO
BV55	BV005500	NR	VITE TE PARZIALE FILETTO PG DIN 931 CL 10.9 M 16 X 55	SCREW PARTIAL THREAD DIN 931 PG CL 10.9 M 16 X 55	VIS TE PARTIELLEMENT FILETÉE PG DIN 931 CL 10.9 M 16 X 55	TEILGEWINDESCHRAUBE DIN 931 PG CL 10.9 M 16 X 55	TORNILLO PARCIALMENTE ROSCADO PG DIN 931 CL 10.9 M 16 X 55
BV56	BV005600	NR	VITE TE TUTTO FILETTO PG DIN 933 CL 8.8 M 16 X 40 Z.BIANCA	SCREW ALL THREAD DIN 933 PG CL 8.8 M 16 X 40 Z. WHITE	VIS ENTIÈREMENT FILETÉE DIN 933 CL 8.8 M 16 X 40 GALVANISATION BLANCHE	SCHRAUBE	TORNILLO
BV57	BV005700	NR	VITE TE PARZIALE FILETTO PG DIN 931 CL 10.9 M 16 X 220	SCREW PARTIAL THREAD DIN 931 PG CL 10.9 M 16 X 220	VIS PARTIELLEMENT FILETÉE DIN 931 CL 10.9 M 16 X 220	SCHRAUBE	TORNILLO
BV58	BV005800	NR	VITE TE 8.8 DIN933 M16X20 TESTA ALTA 8 ZN BIANCA	SCREW M16X20 DIN933 8.8 HEAD HIGH 8 ZN WHITE	VIS 8.8 DIN933 M16X20 TÊTE HAUTE 8 GALVANISATION BLANCHE	SCHRAUBE	TORNILLO
BV59	BV005900	NR	VITE TE TUTTO FILETTO PG DIN 933 CL 8.8 M 12 X 16 Z.BIANCA	SCREW ALL THREAD DIN 933 PG CL 8.8 M 12 X 16 Z. WHITE	VIS ENTIÈREMENT FILETÉE DIN 933 CL 8.8 M 12 X 16 GALVANISATION BLANCHE	SCHRAUBE	TORNILLO
BV60	BV006000	NR	VITE TE PARZIALE FILETTO PG DIN 931 CL 8.8 M 12 X 120 Z.BIANCA	SCREW PARTIAL THREAD DIN 931 PG CL 8.8 M 12 X 120 Z. WHITE	VIS PARTIELLEMENT FILETÉE DIN 931 CL 8.8 M 12 X 120 GALVANISATION BLANCHE	SCHRAUBE	TORNILLO
BV61	BV006100	NR	VITE TE PARZIALE FILETTO PG DIN 931 CL 8.8 M 10 X 50 Z.BIANCA	SCREW PARTIAL THREAD DIN 931 PG CL 8.8 M 10 X 50 Z. WHITE	VIS TE PARTIELLEMENT FILETÉE PG DIN 931 CL 8.8 M 10 X 50 Z.BLANC	TEILGEWINDESCHRAUBE DIN 931 PG CL 8.8 M 10 X 50 Z. WEIß	TORNILLO PARCIALMENTE ROSCADO PG DIN 931 CL 8.8 M 10 X 50 GALVANIZADO BLANCO





POS	Codice	U.M.	 Descrizione	 Description	 Designation	 Benennung	 Descripción
BV62	BV006200	NR	VITE TE TUTTO FILETTO PG DIN 933 CL 8.8 M 10 X 35 Z.BIANCA	SCREW ALL THREAD DIN 933 PG CL 8.8 M 10 X 35 Z. WHITE	VIS TE ENTIÈREMENT FILETÉE PG DIN 933 CL 8.8 M 10 X 35 Z.BLANC	VOLLGEWINDESCHRAUBE DIN 933 PG CL 8.8 M 10 X 35 Z. WEIß	TORNILLO TOTALMENTE ROSCADO PG DIN 933 CL 8.8 M 10 X 35 GALVANIZADO BLANCO
BV63	BV006300	NR	VITE TSPEI PG DIN 7991 CL 10.9 M 10 X 30 Z.BIANCA	SCREW DIN 7991 CL 10.9 M 10 X 30 Z. WHITE	VIS DIN 7991 CL 10.9 M 10 X 30 GALVANISATION BLANCHE	SCHRAUBE	TORNILLO
BV64	BV006400	NR	VITE TE TUTTO FILETTO PG DIN 933 CL 8.8 M 10 X 30 Z.BIANCA	SCREW ALL THREAD DIN 933 PG CL 8.8 M 10 X 30 Z. WHITE	VIS TE ENTIÈREMENT FILETÉE PG DIN 933 CL 8.8 M 10 X 30 Z.BLANC	VOLLGEWINDESCHRAUBE DIN 933 PG CL 8.8 M 10 X 30 Z. WEIß	TORNILLO PG DIN 933 CL 8.8 M 10 X 30 GALVANIZADO BLANCO
BV65	BV006500	NR	VITE TCEI PG DIN 912 CL 12.9 M 10 X 25 GEO 321 A	SCREW DIN 912 PG CL 12.9 M 10 X 25 GEO 321 A	VIS DIN 912 PG CL 12.9 M 10 X 25 GEO 321 A	SCHRAUBE DIN 912 PG CL 12.9 M 10 X 25 GEO 321 A	TORNILLO TCEI PG DIN 912 CL 12.9 M 10 X 25 GEO 321 A
BV66	BV006600	NR	VITE TCEI PG DIN 912 CL 8.8 M 10 X 25 Z.BIANCA	SCREW DIN 912 PG CL 8.8 M 10 X 25 Z. WHITE	VIS DIN 912 CL 8.8 M 10 X 25 GALVANISATION BLANCHE	SCHRAUBE	TORNILLO
BV67	BV006700	NR	VITE TE TUTTO FILETTO PG DIN 933 CL 8.8 M 10 X 20 Z.BIANCA	SCREW ALL THREAD DIN 933 PG CL 8.8 M 10 X 20 Z. WHITE	VIS ENTIÈREMENT FILETÉE PG DIN 933 CL 8.8 M 10 X 20 Z.BLANC	VOLLGEWINDESCHRAUBE DIN 933 PG CL 8.8 M 10 X 20 Z. WEIß	TORNILLO TOTALMENTE ROSCADO PG DIN 933 CL 8.8 M 10 X 20 GALVANIZADO BLANCO
BV68	BV006800	NR	VITE TE TUTTO FILETTO PG DIN 933 CL 8.8 M 10 X 18 Z.BIANCA	SCREW ALL THREAD DIN 933 PG CL 8.8 M 10 X 18 Z. WHITE	VIS ENTIÈREMENT FILETÉE DIN 933 PG CL 8.8 M 10 X 18 Z. BLANC	VOLLGEWINDESCHRAUBE DIN 933 PG CL 8.8 M 10 X 18 Z. WEIß	TORNILLO TOTALMENTE ROSCADO PG DIN 933 CL 8.8 M 10 X 18 GALVANIZADO BLANCO
BV69	BV006900	NR	VITE TRILOB. AUTOFORM. TSP CROCE PG DIN 7500-M C15 M 5 X 16 Z.BIANCA	TRILOB SCREW. AUTOFORM. TSP CROSS PG DIN 7500-M C15 M 5 X 16 Z. WHITE	VIS TRILOB. AUTOFORM. TSP CROIX PG DIN 7500-M C15 M 5 X 16 GALVANISATION BLANCHE	SCHRAUBE	TORNILLO
BV70	BV007000	NR	VITE TE PARZIALE FILETTO PG DIN 931 CL 8.8 M 8 X 70 Z.BIANCA	SCREW PARTIAL THREAD DIN 931 PG CL 8.8 M 8 X 70 Z. WHITE	VIS PARTIELLEMENT FILETÉE DIN 931 PG CL 8.8 M 8 X 70 Z. BLANC	TEILGEWINDESCHRAUBE DIN 931 PG CL 8.8 M 8 X 70 Z. WEIß	TORNILLO PARCIALMENTE ROSCADO PG DIN 931 CL 8.8 M 8 X 70 GALVANIZADO BLANCO
BV71	BV007100	NR	VITE TE PARZIALE FILETTO PG DIN 931 CL 8.8 M 8 X 65 Z.BIANCA	SCREW PARTIAL THREAD DIN 931 PG CL 8.8 M 8 X 65 Z. WHITE	VIS PARTIELLEMENT FILETÉE DIN 931 CL 8.8 M 8 X 65 GALVANISÉE BLANCHE	TEILGEWINDESCHRAUBE DIN 931 PG CL 8.8 M 8 X 65 Z. WEIß	TORNILLO PARCIALMENTE ROSCADO DIN 931 CL 8.8 M 8 X 65 GALVANIZADO BLANCO
BV72	BV007200	NR	VITE TE PARZIALE FILETTO PG DIN 931 CL 8.8 M 6 X 55 Z.BIANCA	SCREW PARTIAL THREAD DIN 931 PG CL 8.8 M 6 X 55 Z. WHITE	VIS PARTIELLEMENT FILETÉE DIN 931 CL 8.8 M 6 X 55 GALVANISÉE BLANCHE	TEILGEWINDESCHRAUBE DIN 931 PG CL 8.8 M 6 X 55 Z. WEIß	TORNILLO PARCIALMENTE ROSCADO DIN 931 CL 8.8 M 6 X 55 GALVANIZADO BLANCO





POS	Codice	U.M.	 Descrizione	 Description	 Designation	 Benennung	 Descripción
BV73	BV007300	NR	VITE TCEI PG DIN 912 CL 8.8 M 6 X 55 Z.BIANCA	SCREW DIN 912 PG CL 8.8 M 6 X 55 Z. WHITE	VIS TCEI PG DIN 912 CL 8.8 M 6 X 55 GALVANISATION BLANCHE	SCHRAUBE	TORNILLO
BV74	BV007400	NR	VITE TCEI PG DIN 912 CL 8.8 M 6 X 16 Z.BIANCA	SCREW DIN 912 PG CL 8.8 M 6 X 16 Z. WHITE	VIS DIN 912 CL 8.8 M 6 X 16 GALVANISATION BLANCHE	SCHRAUBE	TORNILLO
BV75	BV007500	NR	VITE TSPEI PG DIN 7991 CL 10.9 M 6 X 10 Z.BIANCA	SCREW DIN 7991 CL 10.9 M 6 X 10 Z. WHITE	VIS DIN 7991 CL 10.9 M 6 X 10 GALVANISATION BLANCHE	SCHRAUBE	TORNILLO
BV76	BV007600	NR	VITE TCEI PG DIN 912 CL 8.8 M 5 X 55 Z.BIANCA	SCREW DIN 912 PG CL 8.8 M 5 X 55 Z. WHITE	VIS DIN 912 CL 8.8 M 5 X 55 GALVANISATION BLANCHE	SCHRAUBE	TORNILLO
BV77	BV007700	NR	VITE TC CROCE PG DIN 7985 CL 4.8 M 6 X 16 Z.BIANCA	CROSS HEAD SCREW DIN 7985 PG CL 4.8 M 6 X 16 Z. WHITE	VIS DIN 7985 CL 4.8 M 6 X 16 GALVANISATION BLANCHE	SCHRAUBE	TORNILLO
BV78	BV007800	NR	VITE TRILOB. AUTOFORM. TC CROCE PG DIN 7500-C C15 M 5 X 12 Z.BIANCA	TRILOB SCREW. AUTOFORM. TC CROSS PG DIN 7500-C C15 M 5 X 12 Z. WHITE	VIS TRILOB. AUTOFORM. TC CROIX PG DIN 7500-C C15 M 5 X 12 GALVANISATION BLANCHE	SCHRAUBE	TORNILLO
BV79	BV007900	NR	VITE TE TUTTO FILETTO PG DIN 933 CL 8.8 M 4 X 35 Z.BIANCA	SCREW ALL THREAD DIN 933 PG CL 8.8 M 4 X 35 Z. WHITE	VIS ENTIÈREMENT FILETÉE DIN 933 CL 8.8 M 4 X 35 GALVANISATION BLANCHE	SCHRAUBE	TORNILLO
BV80	BV008000	NR	VITE AUTOFILETTANTE TE C/BORDINO DIN 6928 C15 4,8X35 Z.BIANCA	TAPPING SCREW TE C / BORDINO DIN 6928 C15 4.8 X35 Z. WHITE	VIS AUTOFILETÉE TE C/BORDINO DIN 6928 C15 4,8X35 GALVANISATION BLANCHE	SCHRAUBE	TORNILLO
BV81	BV008100	NR	VITE TCEI PG DIN 912 CL 12.9 M 3 X 14 Z.D.BIANCA	SCREW DIN 912 M 3 CL 12.9 X 14 Z.D. WHITE	VIS DIN 912 CL 12.9 M 3 X 14 GALVANISATION BLANCHE	SCHRAUBE	TORNILLO
BV82	BV008200	NR	VITE TE PARZIALE FILETTO PG DIN 931 CL 8.8 M 16 X 70 Z.BIANCA	SCREW PARTIAL THREAD DIN 931 PG CL 8.8 M 16 X 70 Z. WHITE	VIS PARTIELLEMENT FILETÉE PG DIN 931 CL 8.8 M 16 X 70 GALVANISATION BLANCHE	SCHRAUBE	TORNILLO
BV83	BV008300	NR	VITE TE PARZIALE FILETTO PG DIN 931 CL 8.8 M 16 X 260 Z.BIANCA	SCREW PARTIAL THREAD DIN 931 PG CL 8.8 M 16 X 260 Z. WHITE	VIS PARTIELLEMENT FILETÉE PG DIN 931 CL 8.8 M 16 X 260 GALVANISATION BLANCHE	SCHRAUBE	TORNILLO
BV84	BV008400	NR	VITE TE PARZIALE FILETTO PG DIN 931 CL 8.8 M 12 X 110 Z.BIANCA	SCREW PARTIAL THREAD DIN 931 PG CL 8.8 M 12 X 110 Z. WHITE	VIS PARTIELLEMENT FILETÉE DIN 931 CL 8.8 M 12 X 110 GALVANISATION BLANCHE	SCHRAUBE	TORNILLO





POS	Codice	U.M.	 Descrizione	 Description	 Designation	 Benennung	 Descripción
BV85	BV008500	NR	VITE TE TUTTO FILETTO PG DIN 933 CL 8.8 M 10 X 40 Z.BIANCA	SCREW THREAD DIN 933 PG CL 8.8 M 10 X 40 Z. WHITE	VIS FILETÉE DIN 933 PG CL 8.8 M 10 X 40 Z. BLANC	TEILGEWINDESCHRAUBE DIN 933 PG CL 8.8 M 10 X 40 Z. WEIß	TORNILLO ROSCADO PG DIN 933 CL 8.8 M 10 X 40 GALVANIZADO BLANCO
BV86	BV008600	NR	VITE TCEI PG DIN 912 CL 8.8 M 8 X 65 Z.BIANCA	SCREW DIN 912 PG CL 8.8 M 8 X 65 Z. WHITE	VIS DIN 912 CL 8.8 M 8 X 65 GALVANISATION BLANCHE	SCHRAUBE	TORNILLO
BV87	BV008700	NR	VITE TCEI PG DIN 912 CL 8.8 M 8 X 20 Z.BIANCA	SCREW DIN 931 PG CL 8.8 M 10 X 40 Z. WHITE	VIS DIN 931 PG CL 8.8 M 10 X 40 Z. BLANC	SCHRAUBE DIN 931 PG CL 8.8 M 10 X 40 Z. WEIß	TORNILLO TCEI PG DIN 912 CL 8.8 M 8 X 20 GALVANIZADO BLANCO
BV88	BV008800	NR	VITE TCEI PG DIN 912 CL 10.9 M 10 X 18 Z.BIANCA	SCREW DIN 912 PG CL 10.9 M 10 X 18 Z. WHITE	VIS DIN 912 CL 10.9 M 10 X 18 GALVANISATION BLANCHE	SCHRAUBE	TORNILLO
BV89	BV008900	NR	VITE TCEI PG DIN 912 CL 8.8 M 8 X 70 Z.BIANCA	SCREW DIN 912 PG CL 8.8 M 8 X 70 Z. WHITE	VIS DIN 912 CL 8.8 M 8 X 70 GALVANISATION BLANCHE	SCHRAUBE	TORNILLO
BV91	BV009100	NR	VITE TE PARZIALE FILETTO PG DIN 931 CL 8.8 M 6 X 40 Z.BIANCA	SCREW PARTIAL THREAD DIN 931 PG CL 8.8 M 6 X 40 Z. WHITE	VIS FILETÉE DIN 931 PG CL 8.8 M 6 X 40 Z. BLANC	VOLLGEWINDESCHRAUBE DIN 931 PG CL 8.8 M 6 X 40 Z. WEIß	TORNILLO PG DIN 931 CL 8.8 M 6 X 40 GALVANIZADO BLANCO
BV92	BV009200	NR	VITE TE TUTTO FILETTO PG DIN 933 CL 8.8 M 10 X 60 Z.BIANCA	SCREW ALL THREAD DIN 933 PG CL 8.8 M 10 X 60 Z. WHITE	VIS	SCHRAUBE	TORNILLO
BV93	BV009300	NR	VITE TSPEI PG DIN 7991 CL 10.9 M 5 X 20 Z.BIANCA	SCREW DIN 7991 CL 10.9 M 5 X 20 Z. WHITE	VIS DIN 7991 CL 10.9 M 5 X 20 GALVANISATION BLANCHE	SCHRAUBE	TORNILLO
BV94	BV009400	NR	VITE TC CROCE PG DIN 7985 CL 4.8 M 4 X 12 Z.BIANCA	CROSS HEAD SCREW DIN 7985 PG CL 4.8 M 4 X 12 Z. WHITE	VIS CROIX DIN 7985 CL 4.8 M 4 X 12 GALVANISATION BLANCHE	SCHRAUBE	TORNILLO
BV95	BV009500	NR	VITE TE TUTTO FILETTO PG DIN 933 CL 8.8 M 4 X 12 Z.BIANCA	SCREW ALL THREAD DIN 933 PG CL 8.8 M 4 X 12 Z. WHITE	VIS ENTIÈREMENT FILETÉE DIN 933 CL 8.8 M 4 X 12 GALVANISATION BLANCHE	SCHRAUBE	TORNILLO
BV96	BV009600	NR	VITE TCEI PG DIN 912 CL 12.9 M 12 X 30 DAC 320A	SCREW DIN 912 CL 12.9 M 12 X 30 DAC 320A	VIS DIN 912 CL 12.9 M 12 X 30 DAC 320A	SCHRAUBE DIN 912 CL 12.9 M 12 X 30 DAC 320A	TORNILLO TCEI PG DIN 912 CL 12.9 M 12 X 30 DAC 320A
BV97	BV009700	NR	VITE AUTOFIL.TESTA MEZZA TONDA C15 4,8 X 13 Z.BIANCA	HALF ROUND HEAD SELF TAPPING SCREW C15 4,8 X 13	VIS AUTOFILETÉE TÊTE DEMI- RONDE C15 4,8 X 13 GALVANISATION BLANCHE	SCHRAUBE	TORNILLO





POS	Codice	U.M.	 Descrizione	 Description	 Designation	 Benennung	 Descripción
BV98	BV009800	NR	VITE TC CROCE PG DIN 7985 CL 4.8 M 4 X 14 Z.BIANCA	SCREW DIN 7985 CL 4.8 M 4 X 14	VIS EN CROIX PG DIN 7985 CL 4.8 M 4 X 14 GALVANISÉE BLANCHE	KREUZSCHLITZSCHRAUBE DIN 7985 CL 4.8 M 4 X 14	TORNILLO CRUZ 7985 CL 4.8 M 4 X 14 GALVANIZADO BLANCO
BV99	BV009900	NR	VITE TE PARZIALE FILETTO PG DIN 931 CL 8.8 M 5 X 65 Z.BIANCA	SCREW PARTIAL THREAD DIN 931 PG CL 8.8 M 5 X 65 Z. WHITE	VIS PARTIELLEMENT FILETÉE DIN 931 CL 8.8 M 5 X 65 GALVANISATION BLANCHE	SCHRAUBE	TORNILLO
BV100	BV010000	NR	VITE AUTOFIL.TESTA MEZZA TONDA C15 4,8 X 16 Z.BIANCA	HALF ROUND HEAD SELF TAPPING SCREW C15 4,8 X 16	VIS AUTOFILETÉE TÊTE DEMI-RONDE C15 4,8 X 16 GALVANISATION BLANCHE	SCHRAUBE	TORNILLO
BV101	BV010100	NR	VITE TSPEI PG DIN 7991 CL 10.9 M 8 X 25 Z.BIANCA	SCREW DIN 7991 CL 10.9 M 8 X 25 Z. WHITE	VIS DIN 7991 CL 10.9 M 8 X 25 GALVANISATION BLANCHE		
BV102	BV010200	NR	VITE TCEI PG DIN 912 CL 8.8 M 4 X 30 Z.BIANCA	SCREW DIN 912 PG CL 8.8 M 4 X 30 WHITE Z	VIS DIN 912 CL 8.8 M 4 X 30 GALVANISATION BLANCHE	SCHRAUBE	TORNILLO
BV103	BV010300	NR	VITE TSPEI PG DIN 7991 CL 10.9 M 5 X 16 Z.BIANCA	SCREW DIN 7991 CL 10.9 M 5 X 16 Z. WHITE	VIS DIN 7991 CL 10.9 M 5 X 16 GALVANISATION BLANCHE	SCHRAUBE	TORNILLO
BV104	BV010400	NR	VITE TCEI BASSA PG DIN 7984 CL 10.9 M 12 X 18 Z.D.BIANCA	SCREW DIN 7984 LOW PG CL 10.9 M 12 X 18 Z. D. WHITE	VIS BASSE DIN 7984 CL 10.9 M 12 X 18 Z. BLANCHE	SCHRAUBE	TORNILLO
BV105	BV010500	NR	VITE TE PARZIALE FILETTO PG DIN 931 CL 8.8 M 12 X 75 Z.BIANCA	SCREW PARTIAL THREAD DIN 931 PG CL 8.8 M 12 X 75 Z. WHITE	VIS PARTIELLEMENT FILETÉE DIN 931 CL 8.8 M 12 X 75 GALVANISATION BLANCHE	SCHRAUBE	TORNILLO
BV106	BV010600	NR	VITE TE TUTTO FILETTO PG DIN 933 CL 8.8 M 8 X 22 Z.BIANCA	SCREW ALL THREAD DIN 933 PG CL 8.8 M 8 X 22 Z. WHITE	VIS ENTIÈREMENT FILETÉE DIN 933 PG CL 8.8 M 8 X 22 Z. BLANC	VOLLGEWINDESCHRAUBE DIN 933 PG CL 8.8 M 8 X 22 Z. WEIß	TORNILLO TOTALMENTE ROSCADO PG DIN 933 CL 8.8 M 8 X 22 GALVANIZADO BLANCO
BV107	BV010700	NR	VITE TE TUTTO FILETTO PG DIN 933 CL 8.8 M 6 X 35 Z.BIANCA	SCREW ALL THREAD DIN 933 PG CL 8.8 M 6 X 35 Z. WHITE	VIS ENTIÈREMENT FILETÉE DIN 933 CL 8.8 M 6 X 35 GALVANISATION BLANCHE	SCHRAUBE	TORNILLO
BV108	BV010800	NR	VITE TE PARZIALE FILETTO PG DIN 931 CL 8.8 M 4 X 45 Z.BIANCA	SCREW PARTIAL THREAD DIN 931 PG CL 8.8 M 4 X 45 Z. WHITE	VIS PARTIELLEMENT FILETÉE DIN 931 CL 8.8 M 4 X 45 GALVANISATION BLANCHE	SCHRAUBE	TORNILLO
BV109	BV010900	NR	VITE TE TUTTO FILETTO PG DIN 933 CL 10.9 M 16 X 45 Z.D.BIANCA	SCREW ALL THREAD DIN 933 PG CL 10.9 M 16 X 45 ZD WHITE	VIS ENTIÈREMENT FILETÉE DIN 933 CL 10.9 M 16 X 45 GALVANISATION BLANCHE	SCHRAUBE	TORNILLO

POS	Codice	U.M.	 Descrizione	 Description	 Designation	 Benennung	 Descripción
BV110	BV011000	NR	VITE TE PARZIALE FILETTO PG DIN 931 CL 10.9 M 16 X 100	SCREW PARTIAL THREAD DIN 931 PG CL 10.9 M 16 X 100	VIS PARTIELLEMENT FILETÉE DIN 931 CL 10.9 M 16 X 100	SCHRAUBE	TORNILLO
BV111	BV011100	NR	VITE TE PARZIALE FILETTO PG DIN 931 CL 10.9 M 16 X 105	SCREW PARTIAL THREAD DIN 931 PG CL 10.9 M 16 X 105	VIS PARTIELLEMENT FILETÉE DIN 931 CL 10.9 M 16 X 105	SCHRAUBE	TORNILLO
BV112	BV011200	NR	VITE TE TUTTO FILETTO PG DIN 933 CL 8.8 M 10 X 25 Z.BIANCA	SCREW ALL THREAD DIN 933 PG CL 8.8 M 10 X 25 Z. WHITE	VIS ENTIÈREMENT FILETÉE DIN 933 PG CL 8.8 M 10 X 25 Z. BLANC	VOLLGEWINDESCHRAUBE DIN 933 PG CL 8.8 M 10 X 25 Z. WEIß	TORNILLO TOTALMENTE ROSCADO PG DIN 933 CL 8.8 M 10 X 25 GALVANIZADO BLANCO
BV113	BV011300	NR	VITE TSPEI PG DIN 7991 CL 10.9 M 6 X 50 Z.BIANCA	TSPEI PG SCREW DIN 7991 CL 10.9 M 6 X 50 Z. WHITE	VIS DIN 7991 CL 10.9 M 6 X 50 Z. BLANC	TSPEI PG SCHRAUBE DIN 7991 CL 10.9 M 6 X 50 Z. WEIß	TORNILLO TSPEI PG DIN 7991 CL 10.9 M 6 X 50 GALVANIZADO BLANCO
BV114	BV011400	NR	VITE TSPEI PG DIN 7991 CL 10.9 M 8 X 25 Z.BIANCA	TSPEI PG SCREW DIN 7991 CL 10.9 M 8 X 25 Z. WHITE	VIS DIN 7991 CL 10.9 M 8 X 25 GALVANISATION BLANCHE	SCHRAUBE	TORNILLO
BV115	BV011500	NR	VITE TE TUTTO FILETTO PG DIN 933 CL 8.8 M 10 X 45 Z.BIANCA	SCREW ALL THREAD DIN 933 PG CL 8.8 M 10 X 45 Z. WHITE	VIS ENTIÈREMENT FILETÉE DIN 933 CL 8.8 M 10 X 45 GALVANISATION BLANCHE	SCHRAUBE	TORNILLO
BV116	BV011600	NR	VITE TE TUTTO FILETTO PG DIN 933 CL 8.8 M 5 X 8 Z.BIANCA	SCREW ALL THREAD DIN 933 PG CL 8.8 M 5 X 8 Z. WHITE	VIS ENTIÈREMENT FILETÉE DIN 933 CL 8.8 M 5 X 8 GALVANISATION BLANCHE	SCHRAUBE	TORNILLO
BV117	BV011700	NR	VITE TE TUTTO FILETTO PG DIN 933 CL 8.8 M 8 X 18 Z.BIANCA	SCREW ALL THREAD DIN 933 PG CL 8.8 M 8 X 18 Z. WHITE	VIS ENTIÈREMENT FILETÉE DIN 933 CL 8.8 M 8 X 18 GALVANISATION BLANCHE	SCHRAUBE	TORNILLO
BV118	BV011800	NR	VITE TE TUTTO FILETTO PG DIN 933 CL 8.8 M 8 X 40 Z.BIANCA	SCREW ALL THREAD DIN 933 PG CL 8.8 M 8 X 40 Z. WHITE	VIS ENTIÈREMENT FILETÉE DIN 933 PG CL 8.8 M 8 X 40 Z. BLANC	VOLLGEWINDESCHRAUBE DIN 933 PG CL 8.8 M 8 X 40 Z. WEIß	TORNILLO DIN 933 CL 8.8 M 8 X 40 GALVANIZADO BLANCO
BV119	BV011900	NR	VITE TCEI PG DIN 912 CL 8.8 M 8 X 100 Z.BIANCA	SCREW DIN 912 PG CL 8.8 M 8 X 100 Z. WHITE	VIS DIN 912 CL 8.8 M 8 X 100 GALVANISATION BLANCHE	SCHRAUBE	TORNILLO
BV120	BV012000	NR	VITE TCEI PG DIN 912 CL 8.8 M 8 X 110 Z.BIANCA	SCREW DIN 912 PG CL 8.8 M 8 X 110 Z. WHITE	VIS DIN 912 CL 8.8 M 8 X 110 GALVANISATION BLANCHE	SCHRAUBE	TORNILLO
BV121	BV012100	NR	VITE TE PARZIALE FILETTO PG DIN 931 CL 8.8 M 5 X 75 Z.BIANCA	SCREW PARTIAL THREAD DIN 931 PG CL 8.8 M 5 X 75 Z. WHITE	VIS PARTIELLEMENT FILETÉE DIN 931 CL 8.8 M 5 X 75 GALVANISATION BLANCHE	SCHRAUBE	TORNILLO







POS	Codice	U.M.	 Descrizione	 Description	 Designation	 Benennung	 Descripción
BV122	BV012200	NR	VITE TE PARZIALE FILETTO PG DIN 931 CL 8.8 M 12 X 130 Z.BIANCA	SCREW PARTIAL THREAD DIN 931 PG CL 8.8 M 12 X 130 Z. WHITE	VIS PARTIELLEMENT FILETÉE DIN 931 CL 8.8 M 12 X 130 GALVANISATION BLANCHE	SCHRAUBE	TORNILLO
BV123	BV012300	NR	VITE TC CROCE PG DIN 7985 CL 4.8 M 4 X 8 Z.BIANCA	CROSS HEAD SCREW DIN 7985 PG CL 4.8 M 4 X 8 Z. WHITE	VIS TC EN CROIX PG DIN 7985 CL 4.8 M 4 X 8 Z.BLANC	KREUZSCHLITZCHRAUBE DIN 7985 PG CL 4.8 M 4 X 8 Z. WEIß	TORNILLO TC DE CRUZ PG DIN 7985 CL 4.8 M 4 X 8 GALVANIZADO BLANCO
BV124	BV012400	NR	VITE TCEI PG DIN 912 CL 8.8 M 6 X 40 Z.BIANCA	SCREW DIN 912 PG CL 8.8 M 6 X 40 Z. WHITE	VIS DIN 912 CL 8.8 M 6 X 40 GALVANISATION BLANCHE	SCHRAUBE	TORNILLO
BV125	BV012500	NR	VITE TE TUTTO FILETTO PG DIN 933 CL 8.8 M 4 X 20 Z.BIANCA	SCREW ALL THREAD DIN 933 PG CL 8.8 M 4 X 20 Z. WHITE	VIS ENTIÈREMENT FILETÉE DIN 933 CL 8.8 M 4 X 20 GALVANISATION BLANCHE	SCHRAUBE	TORNILLO
BV126	BV012600	NR	VITE TE UNC ANSI B18.2.1 GR.5 3/8 X 1" Z.BIANCA	SCREW UNC ANSI B18.2.1 GR.5 3/8 X 1" Z. WHITE	VIS UNC ANSI B18.2.1 GR.5 3/8 X 1" GALVANISATION BLANCHE	SCHRAUBE	TORNILLO
BV127	BV012700	NR	VITE TE UNC ANSI B18.2.1 GR.5 3/8 X 1" 1/4Z.BIANCA	SCREW UNC ANSI B18.2.1 GR.5 3/8 X 1" 1/4 Z. WHITE	VIS UNC ANSI B18.2.1 GR.5 3/8 X 1" 1/4 GALVANISATION BLANCHE	SCHRAUBE	TORNILLO
BV128	BV012800	NR	VITE TE TUTTO FILETTO PG DIN 933 CL 8.8 M 4 X 16 Z.BIANCA	SCREW ALL THREAD DIN 933 PG CL 8.8 M 4 X 16 Z. WHITE	VIS ENTIÈREMENT FILETÉE DIN 933 CL 8.8 M 4 X 16 GALVANISATION BLANCHE	SCHRAUBE	TORNILLO
BV129	BV012900	NR	VITE TCEI PG DIN 912 CL 8.8 M 5 X 16 Z.BIANCA	SCREW DIN 912 PG CL 8.8 M 5 X 16 Z. WHITE	VIS DIN 912 CL 8.8 M 5 X 16 GALVANISATION BLANCHE	SCHRAUBE	TORNILLO
BV130	BV013000	NR	VITE TCEI PG DIN 912 CL 8.8 M 3 X 12 Z.BIANCA	SCREW DIN 912 PG CL 8.8 M 3 X 12 Z. WHITE	VIS DIN 912 CL 8.8 M 3 X 12 GALVANISATION BLANCHE	SCHRAUBE	TORNILLO
BV131	BV013100	NR	VITE TSPEI PG DIN 7991 CL 10.9 M 5 X 30 Z.BIANCA	TSPEI PG SCREW DIN 7991 CL 10.9 M 5 X 30 Z. WHITE	VIS DIN 7991 CL 10.9 M 5 X 30 GALVANISATION BLANCHE	SCHRAUBE	TORNILLO
BV132	BV013200	NR	VITE TSPEI PG DIN 7991 CL 10.9 M 5 X 55 Z.BIANCA	TSPEI PG SCREW DIN 7991 CL 10.9 M 5 X 55 Z. WHITE	VIS DIN 7991 CL 10.9 M 5 X 55 GALVANISATION BLANCHE	SCHRAUBE	TORNILLO
BV133	BV013300	NR	VITE TE TUTTO FILETTO PG DIN 933 CL 8.8 M 3 X 25 Z.BIANCA	SCREW ALL THREAD DIN 933 PG CL 8.8 M 3 X 25 Z. WHITE	VIS ENTIÈREMENT FILETÉE DIN 933 CL 8.8 M 3 X 25 GALVANISATION BLANCHE	SCHRAUBE	TORNILLO
BV134	BV013400	NR	VITE TE PARZIALE FILETTO PG DIN 931 CL 8.8 M 10 X 65 Z.BIANCA	SCREW PARTIAL THREAD DIN 931 PG CL 8.8 M 10 X 65 Z. WHITE	VIS PARTIELLEMENT FILETÉE DIN 931 CL 8.8 M 10 X 65 GALVANISATION BLANCHE	SCHRAUBE	TORNILLO





POS	Codice	U.M.	 Descrizione	 Description	 Designation	 Benennung	 Descripción
BV135	BV013500	NR	VITE TCEI PG DIN 912 CL 8.8 M 12 X 50	SCREW DIN 912 CL 9.8 M 12 X 50	VIS DIN 912 CL 8.8 M 12 X 50	SCHRAUBE DIN 912 CL 8.8 M 12 X 50	TORNILLO DIN 912 CL 8.8 M 12 X 50
BV136	BV013600	NR	VITE TSPEI PG DIN 7991 CL 10.9 M 5 X 25 Z.BIANCA	TSPEI PG SCREW DIN 7991 CL 10.9 M 5 X 25 Z. WHITE	VIS DIN 7991 CL 10.9 M 5 X 25 GALVANISATION BLANCHE	SCHRAUBE	TORNILLO
BV137	BV013700	NR	VITE TCEI PG DIN 912 CL 8.8 M 8 X 30	SCREW DIN 912 CL 8.8 M 8 X 30	VIS DIN 912 CL 8.8 M 8 X 30	SCHRAUBE DIN 912 CL 8.8 M 8 X 30	TORNILLO DIN 912 CL 8.8 M 8 X 30
BV138	BV013800	NR	VITE TC CROCE PG DIN 7985 CL 4.8 M 5 X 10 Z.BIANCA	SCREW DIN 7985 CL 4.8 M 5 X 10	VIS CROIX DIN 7985 CL 4.8 M 5 X 10 GALVANISATION BLANCHE	SCHRAUBE	TORNILLO
BV139	BV013900	NR	VITE TCEI PG DIN 912 CL 8.8 M 4 X 25 Z. BIANCA	SCREW DIN 912 CL 8.8 M 4 X 25 Z.WITHE	VIS DIN 912 CL 8.8 M 4 X 25 GALVANISATION BLANCHE	SCHRAUBE	TONILLO
BV140	BV014000	NR	VITE TE PARZIALE FILETTO PG DIN 931 CL 8.8 M 5 X 70 Z.BIANCA	SCREW PARTIAL THREAD DIN 931 PG CL 8.8 M 5 X 70 Z. WHITE	VIS PARTIELLEMENT FILETÉE DIN 931 CL 8.8 M 5 X 70 GALVANISATION BLANCHE	SCHRAUBE	TORNILLO
BV141	BV014100	NR	VITE TE PARZIALE FILETTO PG DIN 931 CL 8.8 M 12 X 90 Z.BIANCA	SCREW PARTIAL THREAD DIN 931 PG CL 8.8 M 12 X 90 Z. WHITE	VIS PARTIELLEMENT FILETÉE DIN 931 CL 8.8 M 12 X 90 GALVANISATION BLANCHE	SCHRAUBE	TORNILLO
BV142	BV014200	NR	VITE TE PARZIALE FILETTO PG DIN 931 CL 8.8 M 8 X 55 Z.BIANCA	SCREW PARTIAL THREAD DIN 931 PG CL 8.8 M 8 X 55 Z. WHITE	VIS PARTIELLEMENT FILETÉE DIN 931 CL 8.8 M 8 X 55 GALVANISATION BLANCHE	SCHRAUBE	TORNILLO
BV143	BV014300	NR	VITE TSPEI PG DIN 7991 CL 10.9 M 10 X 20 Z.BIANCA	TSPEI PG SCREW DIN 7991 CL 10.9 M 10 X 20 Z. WHITE	VIS DIN 7991 CL 10.9 M 10 X 20 GALVANISATION BLANCHE	SCHRAUBE	TORNILLO
BV144	BV014400	NR	VITE TE TUTTO FILETTO PG DIN 933 CL 8.8 M 12 X 20 Z.BIANCA	SCREW ALL THREAD DIN 933 PG CL 8.8 M 12 X 20 Z. WHITE	VIS ENTIÈREMENT FILETÉE DIN 933 CL 8.8 M 12 X 20 GALVANISATION BLANCHE	SCHRAUBE	TORNILLO
BV145	BV014500	NR	VITE TE TUTTO FILETTO PG DIN 933 CL 8.8 M 12 X 35 Z.BIANCA	SCREW ALL THREAD DIN 933 PG CL 8.8 M 12 X 35 Z. WHITE	VIS ENTIÈREMENT FILETÉE DIN 933 PG CL 8.8 M 12 X 35 Z. BLANC	VOLLGEWINDESCHRAUBE DIN 933 PG CL 8.8 M 12 X 35 Z. WEIß	TORNILLO TOTALMENTE ROSCADO DIN 933 CL 8.8 M 12 X 35 GALVANIZADO BLANCO
BV146	BV014600	NR	VITE TE TUTTO FILETTO PF DIN 961 CL 10.9 M 10 X 1,25 X 25 Z.D.BIANCO	ALL PF THREAD HEX HEAD SCREW DIN 961 CL 10.9 M 10 X 1,25 X 25 Z.BIANCA	VIS ENTIÈREMENT FILETÉE DIN 961 CL 10.9 M 10 X 1,25 X 25 GALVANISÉE BLANCHE	VOLLGEWINDESCHRAUBE DIN 961 CL 10.9 M 10 X 1,25 X 25 Z. WEIß	TORNILLO TOTALMENTE ROSCADO DIN 961 CL 10.9 M 10 X 1,25 X 25 GALVANIZADO BLANCO





POS	Codice	U.M.	 Descrizione	 Description	 Designation	 Benennung	 Descripción
BV147	BV014700	NR	VITE TSPEI PARZIALE FILETTO PG DIN 7991 CL 10.9 M 12 X 90 Z.BIANCA	TSPEI PARTIAL THREAD PG SCREW DIN 7991 CL 10.9 M12 X 90 Z. WHITE	VIS TSPEI PG DIN 7991 CL 10.9 M 12 X 90 GALVANISATION BLANCHE	SCHRAUBE	TORNILLO
BV148	BV014800	NR	VITE TSPEI PG DIN 7991 CL 10.9 M 6 X 16 Z.BIANCA	TSPEI PG SCREW DIN 7991 CL 10.9 M6 X 16 Z. WHITE	VIS TSPEI PG DIN 7991 CL 10.9 M 6 X 16 GALVANISATION BLANCHE	SCHRAUBE	TORNILLO
BV149	BV014900	NR	VITE TBEI PG ISO 7380 CL 10.9 M 6 X 20 Z.BIANCA	HEX SOCKET SCREW ISO 7380 PG CL 10.9 M 6 X 20 Z. WHITE	VIS ISO 7380 CL 10.9 M 6 X 20 GALVANISATION BLANCHE	SCHRAUBE	TORNILLO
BV150	BV015000	NR	VITE TE TUTTO FILETTO PG DIN 933 CL 10.9 M 14 X 40 Z.BIANCA	SCREW ALL THREAD DIN 933 PG CL 10.9 M 14 X 40 Z. WHITE	VIS ENTIÈREMENT FILETÉE DIN 933 CL 10.9 M 14 X 40 GALVANISATION BLANCHE	SCHRAUBE	TORNILLO
BV151	BV015100	NR	VITE TE PARZIALE FILETTO PG DIN 931 CL 8.8 M 10 X 85 Z.BIANCA	SCREW PARTIAL THREAD DIN 931 PG CL 8.8 M 10 X 85 Z. WHITE	VIS PARTIELLEMENT FILETÉE DIN 931 PG CL 8.8 M 10 X 85 Z. BLANC	TEILGEWINDESCHRAUBE DIN 931 PG CL 8.8 M 10 X 85 Z. WEIß	TORNILLO PARCIALMENTE ROSCADO PG DIN 931 CL 8.8 M 10 X 85 GALVANIZADO BLANCO
BV152	BV015200	NR	VITE TE PARZIALE FILETTO PG DIN 931 CL 8.8 M 10 X 75 Z.BIANCA	SCREW PARTIAL THREAD DIN 931 PG CL 8.8 M 10 X 75 Z. WHITE	VIS PARTIELLEMENT FILETÉE DIN 931 PG CL 8.8 M 10 X 75 Z. BLANC	TEILGEWINDESCHRAUBE DIN 931 PG CL 8.8 M 10 X 75 Z. WEIß	TORNILLO PARCIALMENTE ROSCADO PG DIN 931 CL 8.8 M 10 X 75 GALVANIZADO BLANCO
BV154	BV015400	NR	VITE TCEI PG DIN 912 CL 8.8 M 8 X 35	SCREW DIN 912 CL 8.8 M 8 X 35	VIS DIN 912 CL 8.8 M 8 X 35	SCHRAUBE DIN 912 CL 8.8 M 8 X 35	TORNILLO TCEI PG DIN 912 CL 8.8 M 8 X 35
BV155	BV015500	NR	VITE TCEI PG DIN 912 CL 8.8 M 5 X 20 GEOMET 321A	SCREW DIN 912 CL 8.8 M 5 X 20 GEOMET 321A	VIS DIN 912 CL 8.8 M 5 X 20 GEOMET 321A	SCHRAUBE DIN 912 CL 8.8 M 5 X 20 GEOMET 321A	TORNILLO TCEI PG DIN 912 CL 8.8 M 5 X 20 GEOMET 321A
BV156	BV015600	NR	VITE TBEI PG ISO 7380 CL 10.9 M 6 X 25 Z.BIANCA	HEX SOCKET SCREW ISO 7380 PG CL 10.9 M 6 X 25 Z. WHITE	VIS ISO 7380 PG CL 10.9 M 6 X 25 Z. BLANC	SCHRAUBE ISO 7380 PG CL 10.9 M 6 X 25 Z. WEIß	TORNILLO TBEI PG ISO 7380 CL 10.9 M 6 X 25 GALVANIZADO BLANCO
BV157	BV015700	NR	VITE TBEI PG ISO 7380 CL 10.9 M 8 X 20 Z.BIANCA	HEX SOCKET SCREW ISO 7380 PG CL 10.9 M 8 X 20 Z. WHITE	VIS ISO 7380 PG CL 10.9 M 8 X 20 Z. BLANC	TBEI PG SCHRAUBE ISO 7380 CL 10.9 M 8 X 20 Z. WEIß	TORNILLO TBEI PG ISO 7380 CL 10.9 M 8 X 20 GALVANIZADO BLANCO
BV158	BV015800	NR	VITE TBEI PG ISO 7380 CL 10.9 M 6 X 70 Z.BIANCA	HEX SOCKET SCREW ISO 7380 PG CL 10.9 M 6 X 70 Z. WHITE	VIS ISO 7380 PG CL 10.9 M 6 X 70 Z. BLANC	TBEI PG SCHRAUBE ISO 7380 PG CL 10.9 M 6 X 70 Z. WEIß	TORNILLO TBEI PG ISO 7380 CL 10.9 M 6 X 70 GALVANIZADO BLANCO

POS	Codice	U.M.	 Descrizione	 Description	 Designation	 Benennung	 Descripción
BV159	BV015900	NR	VITE TBEI PG ISO 7380 CL 10.9 M 10 X 20 Z.BIANCA	HEX SOCKET SCREW ISO 7380 PG CL 10.9 M 10 X 20 Z. WHITE	VIS SO 7380 PG CL 10.9 M 10 X 20 Z. BLANC	TBEI PG SCHRAUBE ISO 7380 PG CL 10.9 M 10 X 20 Z. WEIß	TORNILLO TBEI PG ISO 7380 CL 10.9 M 10 X 20 GALVANIZADO BLANCO
BV160	BV016000	NR	VITE TSPEI PG DIN 7991 CL 10.9 M 4 X 16 Z.BIANCA	TSPEI PG SCREW DIN 7991 CL 10.9 M4 X 16 Z. WHITE	VIS DIN 7991 CL 10.9 M4 X 16 Z. WHITE	TSPEI PG SCHRAUBE DIN 7991 CL 10.9 M4 X 16 Z. WEIß	TORNILLO TSPEI PG DIN 7991 CL 10.9 M 4 X 16 GALVANIZADO BLANCO
BV162	BV016200	NR	VITE TCEI PG DIN 912 CL 12.9 M14 X 45 GEOMET 321A	SCREW DIN 912 CL 12.9 M14 X 45 GEOMET 321A	VIS TCEI PG DIN 912 CL 12.9 M14 X 45 GEOMET 321A	SCHRAUBE TCEI PG DIN 912 CL 12.9 M14 X 45 GEOMET 321A	TORNILLO TCEI PG DIN 912 CL 12.9 M14 X 45 GEOMET 321A
BV163	BV016300	NR	VITE TCEI PG DIN 912 CL 8.8 M6 X 35	SCREW DIN 912 CL 8.8 M6 X 35	VIS DIN 912 CL 8.8 M6 X 35	SCHRAUBE DIN 912 CL 8.8 M6 X 35	TORNILLO DIN 912 CL 8.8 M6 X 35
BV164	BV016400	NR	VITE TCEI PG DIN 912 CL 8.8 M10 X 35	SCREW DIN 912 CL 8.8 M10 X 35	VIS DIN 912 CL 8.8 M10 X 35	SCHRAUBE DIN 912 CL 8.8 M10 X 35	TORNILLO DIN 912 CL 8.8 M10 X 35
BV165	BV016500	NR	VITE TE TUTTO FILETTO PG DIN 933 CL 8.8 M8 X 12 Z.BIANCA	SCREW ALL THREAD DIN 933 PG CL 8.8 M8 X 12 Z. WHITE	VIS ENTIÈREMENT FILETÉE DIN 933 PG CL 8.8 M8 X 12 Z. BLANC	VOLLGEWINDESCHRAUBE DIN 933 PG CL 8.8 M8 X 12 Z. WEIß	TORNILLO TOTALMENTE ROSCADO PG DIN 933 CL 8.8 M8 X 12 GALVANIZADO BLANCO
BV166	BV016600	NR	VITE TCEI PG DIN 912 CL 8.8 M4 X 20 Z. BIANCA	SCREW DIN 912 CL 8.8 M4 X 20 Z. WITHE	VIS DIN 912 CL 8.8 M4 X 20	SCHRAUBE DIN 912 CL 8.8 M4 X 20	TORNILLO TCEI PG DIN 912 CL 8.8 M4 X 20
BV167	BV016700	NR	VITE TCEI PG DIN 912 CL 8.8 M4 X 20 GEOMET 321A	ALL PF THREAD HEX HEAD SCREW DIN 961 CL 8.8 M 12 X 1,25 X 30 Z.BIANCA	VIS ENTIÈREMENT FILETÉE DIN 961 CL 8.8 M 12 X 1,25 X 30 Z.BLANC	VOLLGEWINDESCHRAUBE DIN 961 CL 8.8 M 12 X 1,25 X 30 Z. WEIß	TORNILLO TOTALMENTE ROSCADO TCEI PG DIN 912 CL 8.8 M4 X 20 GEOMET 321A
BV168	BV016800	NR	VITE TE TUTTO FILETTO PF DIN 961 CL 8.8 M 10 X 1,25 X 30 Z.BIANCA	ALL PF THREAD HEX HEAD SCREW DIN 961 CL 8.8 M 10 X 1,25 X 30 Z.BIANCA	VIS ENTIÈREMENT FILETÉE DIN 961 CL 8.8 M 10 X 1,25 X 30 Z.BLANC	VOLLGEWINDESCHRAUBE DIN 961 CL 8.8 M 10 X 1,25 X 30 Z. WEIß	TORNILLO TOTALMENTE ROSCADO PF DIN 961 CL 8.8 M 10 X 1,25 X 30 GALVANIZADO BLANCO
BV169	BV016900	NR	VITE TCEI PG DIN 912 CL 8.8 M 10 X 1,25 X 30 ZINCATA BIANCA	SCREW DIN 912 CL 8.8 M10 X 1,25 X 30	VIS DIN 912 CL 8.8 M10 X 1,25 X 30	SCHRAUBE DIN 912 CL 8.8 M10 X 1,25 X 30	TORNILLO TCEI PG DIN 912 CL 8.8 M 10 X 1,25 X 30
BV170	BV017000	NR	VITE TE PARZIALE FILETTO PF DIN 960 CL 8.8 M 10 X 1,25 X 60 Z.BIANCA	PARTIAL PF THREAD HEX HEAD SCREW DIN 960 CL 8.8 M 10 X 1,25 X 60 Z.BIANCA	VIS FILETÉE DIN 960 CL 8.8 M 10 X 1,25 X 60 Z.BLANC	VOLLGEWINDESCHRAUBE DIN 960 CL 8.8 M 10 X 1,25 X 60 Z. WEIß	TORNILLO ROSCADO DIN 960 CL 8.8 M 10 X 1,25 X 30 GALVANIZADO BLANCO
BV171	BV017100	NR	VITE TE TUTTO FILETTO PF DIN 961 CL 10.9 M 12 X 1,25 X 25 Z.BIANCA	ALL PF THREAD HEX HEAD SCREW DIN 961 CL 10.9 M 12 X 1,25 X 25 Z.BIANCA	VIS ENTIÈREMENT FILETÉE DIN 961 CL 10.9 M 12 X 1,25 X 25 Z.BLANC	VOLLGEWINDESCHRAUBE DIN 961 CL 10.9 M 12 X 1,25 X 25 Z. WEIß	TORNILLO TOTALMENTE ROSCADO DIN 961 CL 10.9 M 12 X 1,25 X 25 GALVANIZADO BLANCO





POS	Codice	U.M.	 Descrizione	 Description	 Designation	 Benennung	 Descripción
BV172	BV017200	NR	VITE TCEI UNC ASME/ANSI B18.3 ASTM A 574 5/8 X 11/2 GEO 321A	VITE TCEI UNC ASME/ANSI B18.3 ASTM A 574 5/8 X 11/2 GEO 321A	VIS TCEI UNC ASME/ANSI B18.3 ASTM A 574 5/8 X 11/2 GEO 321A	SCHRAUBE TCEI UNC ASME/ANSI B18.3 ASTM A 574 5/8 X 11/2 GEO 321A	TORNILLO TCEI UNC ASME/ANSI B18.3 ASTM A 574 5/8 X 11/2 GEO 321A
BV173	BV017300	NR	VITE TE TUTTO FILETTO PG DIN 933 CL 8.8 M12 X 30 Z.BIANCA	SCREW ALL THREAD DIN 933 PG CL 8.8 M12 X 30 Z. WHITE	VIS ENTIÈREMENT FILETÉE DIN 933 PG CL 8.8 M12 X 30 Z. BLANC	VOLLGEWINDESCHRAUBE DIN 933 PG CL 8.8 M12 X 30 Z. WEIß	TORNILLO TOTALMENTE ROSCADO DIN 933 CL 8.8 M12 X 30 GALVANIZADO BLANCO
BV174	BV017400	NR	VITE TE TUTTO FILETTO PG DIN 933 CL 8.8 M5 X 45 Z.BIANCA	SCREW ALL THREAD DIN 933 PG CL 8.8 M5 X 45 Z. WHITE	VIS ENTIÈREMENT FILETÉE DIN 933 PG CL 8.8 M5 X 45 Z. BLANC	VOLLGEWINDESCHRAUBE DIN 933 PG CL 8.8 M5 X 45 Z. WEIß	TORNILLO TOTALMENTE ROSCADO DIN 933 CL 8.8 M5 X 45 GALVANIZADO BLANCO
BV175	BV017500	NR	VITE TE PARZIALE FILETTO PG DIN 931 CL 8.8 M 12 X 80 Z.BIANCA	SCREW PARTIAL THREAD DIN 931 PG CL 8.8 M12 X 80 Z. WHITE	VIS FILETÉE DIN 931 PG CL 8.8 M12 X 80 Z. BLANC	VOLLGEWINDESCHRAUBE DIN 931 PG CL 8.8 M12 X 80 Z. WEIßE	VIS ROSCADO DIN 931 CL 8.8 M12 X 80 GALVANIZADO BLANCO
BV176	BV017600	NR	VITE TCEI PG DIN 912 CL 8.8 M 6 X 25 Z.BIANCA	SCREW DIN 912 CL 8.8 M6 X 25	VIS DIN 912 CL 8.8 M6 X 25	SCHRAUBE DIN 912 CL 8.8 M6 X 25	TORNILLO TCEI PG DIN 912 CL 8.8 M6 X 25
BV177	BV017700	NR	VITE TE PARZIALE FILETTO PG DIN 931 CL 8.8 M 12 X 85 Z.BIANCA	SCREW PARTIAL THREAD DIN 931 PG CL 8.8 M12 X 85 Z. WHITE	VIS FILETÉE DIN 931 PG CL 8.8 M12 X 85 Z. BLANC	VOLLGEWINDESCHRAUBE DIN 931 PG CL 8.8 M12 X 85 Z. WEIßE	TORNILLO ROSCADO DIN 931 CL 8.8 M12 X 85 GALVANIZADO BLANCO
BV178	BV017800	NR	VITE TE TUTTO FILETTO PG DIN 933 CL 8.8 M8 X 90 Z.BIANCA	SCREW ALL THREAD DIN 933 PG CL 8.8 M8 X 90 Z. WHITE	VIS ENTIÈREMENT FILETÉE DIN 933 PG CL 8.8 M8 X 90 Z. BLANC	VOLLGEWINDESCHRAUBE DIN 933 PG CL 8.8 M8 X 90 Z. WEIßE	TORNILLO TOTALMENTE ROSCADO DIN 933 CL 8.8 M8 X 90 GALVANIZADO BLANCO
BV179	BV017900	NR	VITE TE TUTTO FILETTO PG DIN 933 CL 8.8 M5 X 40 Z.BIANCA	SCREW ALL THREAD DIN 933 PG CL 8.8 M5 X 40 Z. WHITE	VIS ENTIÈREMENT FILETÉE DIN 933 PG CL 8.8 M5 X 40 Z. BLANC	VOLLGEWINDESCHRAUBE DIN 933 PG CL 8.8 M5 X 40 Z. WEIßE	TORNILLO TOTALMENTE ROSCADO PG DIN 933 CL 8.8 M5 X 40 GALVANIZADO BLANCO
BV180	BV018000	NR	VITE TE TUTTO FILETTO PG DIN 933 CL 8.8 M6 X 75 Z.BIANCA	SCREW ALL THREAD DIN 933 PG CL 8.8 M6 X 75 Z. WHITE	VIS ENTIÈREMENT FILETÉE DIN 933 PG CL 8.8 M6 X 75 Z. BLANC	VOLLGEWINDESCHRAUBE DIN 933 PG CL 8.8 M6 X 75 Z. WEIß	TORNILLO TOTALMENTE ROSCADO DIN 933 CL 8.8 M6 X 75 GALVANIZADO BLANCO
BV182	BV018200	NR	VITE TE TUTTO FILETTO PG DIN 933 CL 10.9 M 16 X 70 Z.BIANCA	SCREW ALL THREAD DIN 933 PG CL 10.9 M 16 X 70 Z. WHITE	VIS ENTIÈREMENT FILETÉE DIN 933 CL 10.9 M 16 X 70 GALVANISÉE BLANCHE	VOLLGEWINDESCHRAUBE DIN 933 PG CL 10.9 M 16 X 70 Z. WEIß	TORNILLO TOTALMENTE FILETADO DIN 933 CL 10.9 M 16 X 70 TOTALMENTE ROSCADO
BV183	BV018300	NR	VITE TE TUTTO FILETTO PG DIN 933 CL 8.8 M5 X 10 Z.BIANCA	SCREW ALL THREAD DIN 933 PG CL 8.8 M5 X 10 Z. WHITE	VIS ENTIÈREMENT FILETÉE DIN 933 PG CL 8.8 M5 X 10 Z. BLANC	VOLLGEWINDESCHRAUBE DIN 933 PG CL 8.8 M5 X 10 Z. WEIß	TORNILLO TOTALMENTE ROSCADO DIN 933 CL 8.8 M5 X 10 GALVANIZADO BLANCO







POS	Codice	U.M.	 Descrizione	 Description	 Designation	 Benennung	 Descripción
BV184	BV018400	NR	VITE TE TUTTO FILETTO PG DIN 933 CL 8.8 M10 X 16 Z.BIANCA	SCREW ALL THREAD DIN 933 PG CL 8.8 M10 X 16 Z. WHITE	VIS ENTIÈREMENT FILETÉE DIN 933 PG CL 8.8 M10 X 16 Z. BLANC	VOLLGEWINDESCHRAUBE DIN 933 PG CL 8.8 M10 X 16 Z. WEIß	TORNILLO TOTALMENTE ROSCADO DIN 933 CL 8.8 M10 X 16 GALVANIZADO BLANCO
BV185	BV018500	NR	VITE TCEI PG DIN 912 CL 8.8 M 8 X 55 Z.BIANCA	SCREW DIN 912 CL 8.8 M8 X 55	VIS DIN 912 CL 8.8 M8 X 55	SCHRAUBE DIN 912 CL 8.8 M8 X 55	TORNILLO DIN 912 CL 8.8 M8 X 55
BV186	BV018600	NR	VITE TCEI PG DIN 912 CL 12.9 M10 X 30 GEOMET 321A	SCREW DIN 912 CL 12.9 M10 X 30 GEOMET 321A	VIS DIN 912 CL 12.9 M10 X 30 GEOMET 321A	SCHRAUBE DIN 912 CL 12.9 M10 X 30 GEOMET 321A	TORNILLO DIN 912 CL 12.9 M10 X 30 GEOMET 321A
BV187	BV018700	NR	VITE TCEI PG DIN 912 CL 12.9 M14 X 40 GEOMET 321A	SCREW DIN 912 CL 12.9 M14 X 40 GEOMET 321A	VIS TCEI PG DIN 912 CL 12.9 M14 X 40 GEOMET 321A	SCHRAUBE DIN 912 CL 12.9 M14 X 40 GEOMET 321A	TORNILLO DIN 912 CL 12.9 M14 X 40 GEOMET 321A
BV188	BV018800	NR	VITE TE TUTTO FILETTO PG DIN 933 CL 8.8 M 12 X 60 Z.BIANCA	SCREW ALL THREAD DIN 933 PG CL 8.8 M12 X 60 Z. WHITE	VIS ENTIÈREMENT FILETÉE DIN 933 PG CL 8.8 M12 X 60 Z. BLANC	VOLLGEWINDESCHRAUBE DIN 933 PG CL 8.8 M12 X 60 Z. WEIßE	VIS TOTALMENTE ROSCADO DIN 933 CL 8.8 M12 X 60 GALVANIZADO BLANCO
BV189	BV018900	NR	VITE TE TUTTO FILETTO PG DIN 933 CL 8.8 M 12 X 55 Z.BIANCA	SCREW ALL THREAD DIN 933 PG CL 8.8 M12 X 55 Z. WHITE	VIS ENTIÈREMENT FILETÉE DIN 933 PG CL 8.8 M12 X 55 Z. BLANC	VOLLGEWINDESCHRAUBE DIN 933 PG CL 8.8 M12 X 55 Z. WEIßE	VIS TOTALMENTE ROSCADO DIN 933 CL 8.8 M12 X 55 GALVANIZADO BLANCO
BV190	BV019000	NR	VITE TE TUTTO FILETTO PG DIN 933 CL 8.8 M 12 X 50 Z.BIANCA	SCREW ALL THREAD DIN 933 PG CL 8.8 M12 X 50 Z. WHITE	VIS ENTIÈREMENT FILETÉE DIN 933 PG CL 8.8 M12 X 50 Z. BLANC	VOLLGEWINDESCHRAUBE DIN 933 PG CL 8.8 M12 X 50 Z. WEIßE	VIS TOTALMENTE ROSCADO DIN 933 CL 8.8 M12 X 50 GALVANIZADO BLANCO
BV191	BV019100	NR	VITE TE TUTTO FILETTO PG DIN 933 CL 8.8 M 16 X 50 Z.BIANCA	SCREW ALL THREAD DIN 933 PG CL 8.8 M16 X 50 Z. WHITE	VIS ENTIÈREMENT FILETÉE DIN 933 PG CL 8.8 M16 X 50 Z. BLANC	VOLLGEWINDESCHRAUBE DIN 933 PG CL 8.8 M16 X 50 Z. WEIßE	VIS TOTALMENTE ROSCADO DIN 933 CL 8.8 M16 X 50 GALVANIZADO BLANCO
BV192	BV019200	NR	VITE TE TUTTO FILETTO PG DIN 933 CL 8.8 M 16 X 55 Z.BIANCA	SCREW ALL THREAD DIN 933 PG CL 8.8 M16 X 55 Z. WHITE	VIS ENTIÈREMENT FILETÉE DIN 933 PG CL 8.8 M16 X 55 Z. BLANC	VOLLGEWINDESCHRAUBE DIN 933 PG CL 8.8 M16 X 55 Z. WEIßE	VIS TOTALMENTE ROSCADO DIN 933 CL 8.8 M16 X 55 GALVANIZADO BLANCO
BV193	BV019300	NR	VITE TE PARZIALE FILETTO PG DIN 931 CL 8.8 M 10 X 55 Z.BIANCA	SCREW PARTIAL THREAD DIN 931 PG CL 8.8 M 10 X 55 Z. WHITE	VIS PARTIELLEMENT FILETÉE DIN 931 PG CL 8.8 M 10 X 55 Z. BLANC	TEILGEWINDESCHRAUBE DIN 931 PG CL 8.8 M 10 X 55 Z. WEIß	TORNILLO PARCIALMENTE ROSCADO PG DIN 931 CL 8.8 M 10 X 55 GALVANIZADO BLANCO
BV194	BV019400	NR	VITE TE PARZIALE FILETTO PG DIN 931 CL 8.8 M 16 X 230 Z.BIANCA	SCREW PARTIAL THREAD DIN 931 PG CL 8.8 M 16 X 230 Z. WHITE	VIS PARTIELLEMENT FILETÉE DIN 931 PG CL 8.8 M 16 X 230 Z. BLANC	TEILGEWINDESCHRAUBE DIN 931 PG CL 8.8 M 16 X 230 Z. WEIß	TORNILLO PARCIALMENTE ROSCADO PG DIN 931 CL 8.8 M 16 X 230 GALVANIZADO BLANCO



POS	Codice	U.M.	 Descrizione	 Description	 Designation	 Benennung	 Descripción
BV195	BV019500	NR	VITE TE PARZIALE FILETTO PG DIN 931 CL 8.8 M 6 X 50 Z.BIANCA	SCREW PARTIAL THREAD DIN 931 PG CL 8.8 M 6 X 50 Z. WHITE	VIS PARTIELLEMENT FILETÉE DIN 931 PG CL 8.8 M 6 X 50 Z. BLANC	TEILGEWINDESCHRAUBE DIN 931 PG CL 8.8 M 6 X 50 Z. WEIß	TORNILLO PARCIALMENTE ROSCADO PG DIN 931 CL 8.8 M 6 X 50 GALVANIZADO BLANCO
BV196	BV019600	NR	VITE TE PARZIALE FILETTO PG DIN 931 CL 8.8 M 6 X 65 Z.BIANCA	SCREW PARTIAL THREAD DIN 931 PG CL 8.8 M 6 X 65 Z. WHITE	VIS PARTIELLEMENT FILETÉE DIN 931 PG CL 8.8 M 6 X 65 Z. BLANC	TEILGEWINDESCHRAUBE DIN 931 PG CL 8.8 M 6 X 65 Z. WEIß	TORNILLO PARCIALMENTE ROSCADO PG DIN 931 CL 8.8 M 6 X 65 GALVANIZADO BLANCO
BV197	BV019700	NR	VITE TE PARZIALE FILETTO PG DIN 931 CL 8.8 M 8 X 45 Z.BIANCA	SCREW PARTIAL THREAD DIN 931 PG CL 8.8 M 8 X 45 Z. WHITE	VIS PARTIELLEMENT FILETÉE DIN 931 PG CL 8.8 M 8 X 45 Z. BLANC	TEILGEWINDESCHRAUBE DIN 931 PG CL 8.8 M 8 X 45 Z. WEIß	TORNILLO PARCIALMENTE ROSCADO PG DIN 931 CL 8.8 M 8 X 45 GALVANIZADO BLANCO
BV198	BV019800	NR	VITE TE PARZIALE FILETTO PG DIN 931 CL 8.8 M 8 X 55 Z.BIANCA	SCREW PARTIAL THREAD DIN 931 PG CL 8.8 M 8 X 55 Z. WHITE	VIS PARTIELLEMENT FILETÉE DIN 931 PG CL 8.8 M 8 X 55 Z. BLANC	TEILGEWINDESCHRAUBE DIN 931 PG CL 8.8 M 8 X 55 Z. WEIß	TORNILLO PARCIALMENTE ROSCADO PG DIN 931 CL 8.8 M 8 X 55 GALVANIZADO BLANCO
BV199	BV019900	NR	VITE TE PARZIALE FILETTO PG DIN 931 CL 8.8 M 8 X 60 Z.BIANCA	SCREW PARTIAL THREAD DIN 931 PG CL 8.8 M 8 X 60 Z. WHITE	VIS PARTIELLEMENT FILETÉE DIN 931 PG CL 8.8 M 8 X 60 Z. BLANC	TEILGEWINDESCHRAUBE DIN 931 PG CL 8.8 M 8 X 60 Z. WEIß	TORNILLO PARCIALMENTE ROSCADO PG DIN 931 CL 8.8 M 8 X 60 GALVANIZADO BLANCO
BV200	BV020000	NR	VITE TE TUTTO FILETTO PG DIN 933 CL 10.9 M 16 X 40	SCREW ALL THREAD DIN 933 PG CL 10.9 M 16 X 40	VIS ENTIÈREMENT FILETÉE DIN 933 CL 10.9 M 16 X 40	VOLLGEWINDESCHRAUBE DIN 933 PG CL 10.9 M 16 X 40	TORNILLO TOTALMENTE FILETADO DIN 933 CL 10.9 M 16 X 40
BV201	BV020100	NR	VITE TSPEI PG DIN 7991 CL 10.9 M16 X 45 Z.BIANCA	TSPEI PG SCREW DIN 7991 CL 10.9 M16 X 45 Z. WHITE	VIS DIN 7991 CL 10.9 M16 X 45 Z. WHITE	TSPEI PG SCHRAUBE DIN 7991 CL 10.9 M16 X 45 Z. WEIß	TORNILLO TSPEI PG DIN 7991 CL 10.9 M 16 X 45 GALVANIZADO BLANCO
BV202	BV020200	NR	VITE TCEI PG DIN 912 CL 12.9 M3 X 12 ZINC. IRIDESCENTE FE/ZN5IVS	SCREW DIN 912 CL 12.9 M3 X 12 ZINC. IRIDESCENTE FE/ZN5IVS	VIS DIN 912 CL 12.9 M3 X 12 ZINC. IRIDESCENTE FE/ZN5IVS	SCHRAUBE DIN 912 CL 12.9 M3 X 12 ZINC. IRIDESCENTE FE/ZN5IVS	TORNILLO DIN 912 CL 12.9 M3 X 12 ZINC. IRIDESCENTE FE/ZN5IVS
BV203	BV020300	NR	VITE TC CROCE PG DIN 7985 CL 4.8 M M 3 X 5 Z.BIANCA	SCREW DIN 7985 CL 4.8 M M 3 X 5	VIS CROIX DIN 7985 CL 4.8 M M 3 X 5 GALVANISATION BLANCHE	SCHRAUBE	TORNILLO
BV204	BV020400	NR	VITE TC CROCE PG DIN 7985 CL 4.8 M M 3 X 8 Z.BIANCA	SCREW DIN 7985 CL 4.8 M M 3 X 8	VIS CROIX DIN 7985 CL 4.8 M M 3 X 8 GALVANISATION BLANCHE	SCHRAUBE	TORNILLO
BV205	BV020500	NR	VITE TTQST DIN 603 CL 4.8 M 8 X 35 Z.BIANCA	TTQST SCREW DIN 603 CL 4.8 M 8 X 35 Z. WHITE			





POS	Codice	U.M.	 Descrizione	 Description	 Designation	 Benennung	 Descripción
BV206	BV020600	NR	VITE TC CROCE PG DIN 7985 CL 4.8 M M 5 X 80 Z.BIANCA	SCREW DIN 7985 CL 4.8 M M 5 X 80	VIS CROIX DIN 7985 CL 4.8 M M 5 X 80 GALVANISATION BLANCHE	SCHRAUBE	TORNILLO
BV207	BV020700	NR	VITE TE PARZIALE FILETTO PG DIN 931 CL 8.8 M 10 X 80 Z.BIANCA	SCREW PARTIAL THREAD DIN 931 PG CL 8.8 M 10 X 80 Z. WHITE	VIS PARTIELLEMENT FILETÉE DIN 931 PG CL 8.8 M 10 X 80 Z. BLANC	TEILGEWINDESCHRAUBE DIN 931 PG CL 8.8 M 10 X 80 Z. WEIß	TORNILLO PARCIALMENTE ROSCADO PG DIN 931 CL 8.8 M 10 X 80 GALVANIZADO BLANCO
BV208	BV020800	NR	VITE TE TUTTO FILETTO PG DIN 933 CL 8.8 M 16 X 35 Z.D.BIANCA	SCREW ALL THREAD DIN 933 PG CL 8.8 M 16 X 35 ZD WHITE	VIS ENTIÈREMENT FILETÉE DIN 933 CL 8.8 M 16 X 35 GALVANISATION BLANCHE	SCHRAUBE	TORNILLO
BV209	BV020900	NR	VITE TE PARZIALE FILETTO PG DIN 931 CL 8.8 M 10 X 95 Z.BIANCA	SCREW PARTIAL THREAD DIN 931 PG CL 8.8 M 10 X 95 Z. WHITE	VIS PARTIELLEMENT FILETÉE DIN 931 PG CL 8.8 M 10 X 95 Z. BLANC	TEILGEWINDESCHRAUBE DIN 931 PG CL 8.8 M 10 X 95 Z. WEIß	TORNILLO PARCIALMENTE ROSCADO PG DIN 931 CL 8.8 M 10 X 95 GALVANIZADO BLANCO
BV210	BV021000	NR	VITE TE TUTTO FILETTO PG DIN 933 CL 8.8 M 6 X 14 Z.D.BIANCA	SCREW ALL THREAD DIN 933 PG CL 8.8 M 6 X 14 ZD WHITE	VIS ENTIÈREMENT FILETÉE DIN 933 CL 8.8 M 6 X 14 GALVANISATION BLANCHE	SCHRAUBE	TORNILLO
BV211	BV021100	NR	VITE TE TUTTO FILETTO PG DIN 933 CL 8.8 M 12 X 25 Z.D.BIANCA	SCREW ALL THREAD DIN 933 PG CL 8.8 M 12 X 25 ZD WHITE	VIS ENTIÈREMENT FILETÉE DIN 933 CL 8.8 M 12 X 25 GALVANISATION BLANCHE	SCHRAUBE	TORNILLO
BV212	BV021200	NR	VITE TE TUTTO FILETTO PG DIN 933 CL 8.8 M 4 X 14 Z.D.BIANCA	SCREW ALL THREAD DIN 933 PG CL 8.8 M 4 X 14 ZD WHITE	VIS ENTIÈREMENT FILETÉE DIN 933 CL 8.8 M 4 X 14 GALVANISATION BLANCHE	SCHRAUBE	TORNILLO
BV213	BV021300	NR	VITE TE TUTTO FILETTO PG DIN 933 CL 10.9 M 16 X 60	SCREW ALL THREAD DIN 933 PG CL 10.9 M 16 X 60	VIS ENTIÈREMENT FILETÉE DIN 933 CL 10.9 M 16 X 60	SCHRAUBE	TORNILLO
BV214	BV021400	NR	VITE TE PARZIALE FILETTO PG DIN 931 CL 8.8 M 6 X 100 Z.BIANCA	SCREW PARTIAL THREAD DIN 931 PG CL 8.8 M 6 X 100 Z. WHITE	VIS PARTIELLEMENT FILETÉE DIN 931 PG CL 8.8 M 6 X 100 Z. BLANC	TEILGEWINDESCHRAUBE DIN 931 PG CL 8.8 M 6 X 100 Z. WEIß	TORNILLO PARCIALMENTE ROSCADO PG DIN 931 CL 8.8 M 6 X 100 GALVANIZADO BLANCO
BV215	BV021500	NR	VITE TE PARZIALE FILETTO PG DIN 931 CL 10.9 M 16 X 110	SCREW PARTIAL THREAD DIN 931 PG CL 10.9 M 16 X 110	VIS PARTIELLEMENT FILETÉE DIN 931 CL 10.9 M 16 X 110	SCHRAUBE	TORNILLO
BV216	BV021600	NR	VITE TE PARZIALE FILETTO PG DIN 931 CL 10.9 M 16 X 240 Z.D.BIANCA	SCREW PARTIAL THREAD DIN 931 PG CL 10.9 M 16 X 240 ZD WHITE	VIS PARTIELLEMENT FILETÉE DIN 931 CL 10.9 M 16 X 240 GALVANISATION BLANCHE	SCHRAUBE	TORNILLO

POS	Codice	U.M.	 Descrizione	 Description	 Designation	 Benennung	 Descripción
BV217	BV021700	NR	VITE TSPEI PG DIN 7991 CL 10.9 M 8 X 30 Z.BIANCA	TSPEI PG SCREW DIN 7991 CL 10.9 M8 X 30 Z. WHITE	VIS TSPEI PG DIN 7991 CL 10.9 M 8 X 30 GALVANISATION BLANCHE	SCHRAUBE	TORNILLO
BV218	BV021800	NR	VITE TSPEI PG DIN 7991 CL 10.9 M 5 X 6 Z.BIANCA	TSPEI PG SCREW DIN 7991 CL 10.9 M5 X 6 Z. WHITE	VIS TSPEI PG DIN 7991 CL 10.9 M 5 X 6 GALVANISATION BLANCHE	SCHRAUBE	TORNILLO
BV219	BV021900	NR	VITE TSPEI PG DIN 7991 CL 10.9 M 5 X 70 Z.BIANCA	TSPEI PG SCREW DIN 7991 CL 10.9 M5 X 70 Z. WHITE	VIS TSPEI PG DIN 7991 CL 10.9 M 5 X 70 GALVANISATION BLANCHE	SCHRAUBE	TORNILLO
BV220	BV022000	NR	VITE TSPEI PG DIN 7991 CL 10.9 M 12 X 35 Z.BIANCA	TSPEI PG SCREW DIN 7991 CL 10.9 M12 X 35 Z. WHITE	VIS TSPEI PG DIN 7991 CL 10.9 M 12 X 35 GALVANISATION BLANCHE	SCHRAUBE	TORNILLO
BV221	BV022100	NR	VITE TCEI PG DIN 912 CL 12.9 M10 X 20 GEOMET 321A	SCREW DIN 912 CL 12.9 M10 X 20 GEOMET 321A	VIS DIN 912 CL 12.9 M10 X 20 GEOMET 321A	SCHRAUBE DIN 912 CL 12.9 M10 X 20 GEOMET 321A	TORNILLO DIN 912 CL 12.9 M10 X 20 GEOMET 321A
BV222	BV022200	NR	VITE TCEI PG DIN 912 CL 12.9 M8 X 90 GEOMET 321A	SCREW DIN 912 CL 12.9 M8 X 90 GEOMET 321A	VIS DIN 912 CL 12.9 M8 X 90 GEOMET 321A	SCHRAUBE DIN 912 CL 12.9 M8 X 90 GEOMET 321A	TORNILLO DIN 912 CL 12.9 M8 X 90 GEOMET 321A
BV223	BV022300	NR	VITE TCEI PG DIN 912 CL 12.9 M3 X 5 ZINC.	SCREW DIN 912 CL 12.9 M3 X 5 ZINC.	VIS DIN 912 CL 12.9 M3 X 5 ZINC.	SCHRAUBE DIN 912 CL 12.9 M3 X 5 ZINC.	TORNILLO DIN 912 CL 12.9 M3 X 5 ZINC.
BV224	BV022400	NR	VITE TBEI PG ISO 7380 CL 10.9 M 8 X 22 Z.BIANCA	HEX SOCKET SCREW ISO 7380 PG CL 10.9 M 8 X 22 Z. WHITE	VIS ISO 7380 PG CL 10.9 M 8 X 22 Z. BLANC	SCHRAUBE ISO 7380 PG CL 10.9 M 8 X 22 Z. WEIß	TORNILLO TBEI PG ISO 7380 CL 10.9 M 8 X 22 GALVANIZADO BLANCO
BV225	BV022500	NR	VITE TE PARZIALE FILETTO PG DIN 931 CL 8.8 M 10 X 100 Z.BIANCA	SCREW PARTIAL THREAD DIN 931 PG CL 8.8 M 10 X 100 Z. WHITE	VIS PARTIELLEMENT FILETÉE DIN 931 PG CL 8.8 M 10 X 100 Z. BLANC	TEILGEWINDESCHRAUBE DIN 931 PG CL 8.8 M 10 X 100 Z. WEIß	TORNILLO PARCIALMENTE ROSCADO PG DIN 931 CL 8.8 M 10 X 100 GALVANIZADO BLANCO
BV226	BV022600	NR	VITE TE PARZIALE FILETTO PG DIN 931 CL 8.8 M 10 X 110 Z.BIANCA	SCREW PARTIAL THREAD DIN 931 PG CL 8.8 M 10 X 110 Z. WHITE	VIS PARTIELLEMENT FILETÉE DIN 931 PG CL 8.8 M 10 X 110 Z. BLANC	TEILGEWINDESCHRAUBE DIN 931 PG CL 8.8 M 10 X 110 Z. WEIß	TORNILLO PARCIALMENTE ROSCADO PG DIN 931 CL 8.8 M 10 X 110 GALVANIZADO BLANCO
BV227	BV022700	NR	VITE TE PARZIALE FILETTO PG DIN 931 CL 10.9 M 12 X 45 Z.D.BIANCA	SCREW PARTIAL THREAD DIN 931 PG CL 10.9 M 12 X 45 ZD WHITE	VIS PARTIEL FILETÉE DIN 931 CL 10.9 M 12 X 45 GALVANISATION BLANCHE	SCHRAUBE	TORNILLO

POS	Codice	U.M.	 Descrizione	 Description	 Designation	 Benennung	 Descripción
BV228	BV022800	NR	VITE TE TUTTO FILETTO PG DIN 933 CL 10.9 M 14 X 35 Z.D.BIANCA	SCREW ALL THREAD DIN 933 PG CL 10.9 M 14 X 35 ZD WHITE	VIS ENTIÈREMENT FILETÉE DIN 933 CL 10.9 M 14 X 35 GALVANISATION BLANCHE	SCHRAUBE	TORNILLO
BV229	BV022900	NR	VITE TSPEI PG DIN 7991 CL 10.9 M 12 X 30 Z.BIANCA	TSPEI PG SCREW DIN 7991 CL 10.9 M12 X 30 Z. WHITE	VIS TSPEI PG DIN 7991 CL 10.9 M 12 X 30 GALVANISATION BLANCHE	SCHRAUBE	TORNILLO
BV230	BV023000	NR	VITE TE FLANGIATA TUTTO FILETTO PG DIN 6921 CL 8.8 M 5 X 12 ZINCONICKEL NERO +SIGILLANTE	FLANGE SCREW ALL THREAD DIN 6921 PG CL 8.8 M 5 X 12 ZINCNICKEL BLACK +SEALANT	VIS	SCHRAUBE	TORNILLO
BV231	BV023100	NR	VITE TE FLANGIATA TUTTO FILETTO PG DIN 6921 CL 8.8 M 6 X 16 ZINCONICKEL NERO +SIGILLANTE	FLANGE SCREW ALL THREAD DIN 6921 PG CL 8.8 M 6 X 16 ZINCNICKEL BLACK +SEALANT	VIS	SCHRAUBE	TORNILLO
BV232	BV023200	NR	VITE TE TUTTO FILETTO PG DIN 933 CL 8.8 M 5 X 25 Z.D.BIANCA	SCREW ALL THREAD DIN 933 PG CL 8.8 M 5 X 25 ZD WHITE	VIS ENTIÈREMENT FILETÉE DIN 933 CL 8.8 M 5 X 25 GALVANISATION BLANCHE	SCHRAUBE	TORNILLO
BV233	BV023300	NR	VITE TE TUTTO FILETTO PG DIN 933 CL 8.8 M 8 X 130 Z.D.BIANCA	SCREW ALL THREAD DIN 933 PG CL 8.8 M 8 X 130 ZD WHITE	VIS ENTIÈREMENT FILETÉE DIN 933 CL 8.8 M 8 X 130 GALVANISATION BLANCHE	SCHRAUBE	TORNILLO
BV234	BV023400	NR	VITE TBEI PG ISO 7380 CL 10.9 M 10 X 30 Z.BIANCA	HEX SOCKET SCREW ISO 7380 PG CL 10.9 M 10 X 30 Z. WHITE	VIS ISO 7380 PG CL 10.9 M 10 X 30 Z. BLANC	SCHRAUBE ISO 7380 PG CL 10.9 M10 X 30 Z. WEIß	TORNILLO TBEI PG ISO 7380 CL 10.9 M 10 X 30 GALVANIZADO BLANCO
BV235	BV023500	NR	VITE TE TUTTO FILETTO PG DIN 933 CL 10.9 M 16 X 35 Z.D.BIANCA	SCREW ALL THREAD DIN 933 PG CL 10.9 M 16 X 35 ZD WHITE	VIS ENTIÈREMENT FILETÉE DIN 933 CL 10.9 M 16 X 35 GALVANISATION BLANCHE	SCHRAUBE	TORNILLO
BV236	BV023600	NR	VITE TE PARZIALE FILETTO PG DIN 931 CL 8.8 M 6 X 45 Z.BIANCA	SCREW PARTIAL THREAD DIN 931 PG CL 8.8 M 6 X 45 Z. WHITE	VIS PARTIELLEMENT FILETÉE DIN 931 PG CL 8.8 M 6 X 45 Z. BLANC	TEILGEWINDESCHRAUBE DIN 931 PG CL 8.8 M 6 X 45 Z. WEIß	TORNILLO PARCIALMENTE ROSCADO PG DIN 931 CL 8.8 M 6 X 45 GALVANIZADO BLANCO
BV237	BV023700	NR	VITE TE TUTTO FILETTO PG DIN 933 CL 10.9 M 12 X 30 Z.D.BIANCA	SCREW ALL THREAD DIN 933 PG CL 10.9 M 12 X 30 ZD WHITE	VIS ENTIÈREMENT FILETÉE DIN 933 CL 10.9 M 12 X 30 GALVANISATION BLANCHE	SCHRAUBE	TORNILLO



POS	Codice	U.M.	 Descrizione	 Description	 Designation	 Benennung	 Descripción
BV238	BV023800	NR	VITE TE PARZIALE FILETTO PG DIN 931 CL 8.8 M 16 X 90 Z.BIANCA	SCREW PARTIAL THREAD DIN 931 PG CL 8.8 M 16 X 90 Z. WHITE	VIS PARTIELLEMENT FILETÉE DIN 931 PG CL 8.8 M 16 X 90 Z. BLANC	TEILGEWINDESCHRAUBE DIN 931 PG CL 8.8 M 16 X 90 Z. WEIß	TORNILLO PARCIALMENTE ROSCADO PG DIN 931 CL 8.8 M 16 X 90 GALVANIZADO BLANCO
BV239	BV023900	NR	VITE TE PARZIALE FILETTO PG DIN 931 CL 8.8 M 12 X 65 Z.BIANCA	SCREW PARTIAL THREAD DIN 931 PG CL 8.8 M 12 X 65 Z. WHITE	VIS PARTIELLEMENT FILETÉE DIN 931 PG CL 8.8 M 12 X 65 Z. BLANC	TEILGEWINDESCHRAUBE DIN 931 PG CL 8.8 M 12 X 65 Z. WEIß	TORNILLO PARCIALMENTE ROSCADO PG DIN 931 CL 8.8 M 12 X 65 GALVANIZADO BLANCO
BV240	BV024000	NR	VITE TC CROCE PG DIN 7985 CL 4.8 M 5 X 20 Z.BIANCA	SCREW DIN 7985 CL 4.8 M 5 X 20	VIS CROIX DIN 7985 CL 4.8 M 5 X 20 GALVANISATION BLANCHE	SCHRAUBE	TORNILLO
BV241	BV024100	NR	VITE TSPEI PG DIN 7991 CL 10.9 M 10 X 35 Z.BIANCA	TSPEI PG SCREW DIN 7991 CL 10.9 M 10 X 35 Z. WHITE	VIS TSPEI PG DIN 7991 CL 10.9 M 10 X 35 GALVANISATION BLANCHE	SCHRAUBE	TORNILLO
BV242	BV024200	NR	VITE TSPEI PG DIN 7991 CL 10.9 M 6 X 12 Z.BIANCA	TSPEI PG SCREW DIN 7991 CL 10.9 M 6 X 12 Z. WHITE	VIS TSPEI PG DIN 7991 CL 10.9 M 6 X 12 GALVANISATION BLANCHE	SCHRAUBE	TORNILLO
BV243	BV024300	NR	VITE TE PARZIALE FILETTO PG DIN 931 CL 8.8 M 12 X 150 Z.BIANCA	SCREW PARTIAL THREAD DIN 931 PG CL 8.8 M 12 X 150 Z. WHITE	VIS PARTIELLEMENT FILETÉE DIN 931 PG CL 8.8 M 12 X 150 Z. BLANC	TEILGEWINDESCHRAUBE DIN 931 PG CL 8.8 M 12 X 150 Z. WEIß	TORNILLO PARCIALMENTE ROSCADO PG DIN 931 CL 8.8 M 12 X 150 GALVANIZADO BLANCO
BV244	BV024400	NR	VITE TCEI PG DIN 912 CL 8.8 M5 X 50 ZINGATA BIANCA	SCREW DIN 912 CL 8.8 M5 X 50	VIS DIN 912 CL 8.8 M5 X 50	SCHRAUBE DIN 912 CL 8.8 M5 X 50	TORNILLO DIN 912 CL 8.8 M5 X 50
BV245	BV024500	NR	VITE TE PARZIALE FILETTO PG DIN 931 CL 8.8 M 8 X 110 Z.BIANCA	SCREW PARTIAL THREAD DIN 931 PG CL 8.8 M 8 X 110 Z. WHITE	VIS PARTIELLEMENT FILETÉE DIN 931 PG CL 8.8 M 8 X 110 Z. BLANC	TEILGEWINDESCHRAUBE DIN 931 PG CL 8.8 M 8 X 110 Z. WEIß	TORNILLO PARCIALMENTE ROSCADO PG DIN 931 CL 8.8 M 8 X 110 GALVANIZADO BLANCO
BV246	BV024600	NR	VITE TE PARZIALE FILETTO PG DIN 931 CL 8.8 M 8 X 40 Z.BIANCA	SCREW PARTIAL THREAD DIN 931 PG CL 8.8 M 8 X 40 Z. WHITE	VIS PARTIELLEMENT FILETÉE DIN 931 PG CL 8.8 M 8 X 40 Z. BLANC	TEILGEWINDESCHRAUBE DIN 931 PG CL 8.8 M 8 X 40 Z. WEIß	TORNILLO PARCIALMENTE ROSCADO PG DIN 931 CL 8.8 M 8 X 40 GALVANIZADO BLANCO
BV247	BV024700	NR	VITE TE TUTTO FILETTO PG DIN 933 CL 8.8 M 5 X 50 Z.D.BIANCA	SCREW ALL THREAD DIN 933 PG CL 8.8 M 5 X 50 ZD WHITE	VIS ENTIÈREMENT FILETÉE DIN 933 CL 8.8 M 5 X 50 GALVANISATION BLANCHE	SCHRAUBE	TORNILLO
BV248	BV024800	NR	VITE TCEI PG DIN 912 CL 8.8 M5 X 18 Z. BIANCA	SCREW DIN 912 CL 8.8 M5 X 18 Z. WHITE	VIS DIN 912 CL 8.8 M5 X 18	SCHRAUBE DIN 912 CL 8.8 M5 X 18	TORNILLO DIN 912 CL 8.8 M5 X 18

POS	Codice	U.M.	 Descrizione	 Description	 Designation	 Benennung	 Descripción
BV249	BV024900	NR	VITE TSPEI PG DIN 7991 CL 10.9 M 5 X 65 Z.BIANCA	TSPEI PG SCREW DIN 7991 CL 10.9 M 5 X 65 Z. WHITE	VIS TSPEI PG DIN 7991 CL 10.9 M 5 X 65 GALVANISATION BLANCHE	SCHRAUBE	TORNILLO
BV251	BV025100	NR	VITE TSPEI PG DIN 7991 CL 10.9 M 8 X 35 Z.BIANCA	TSPEI PG SCREW DIN 7991 CL 10.9 M 8 X 35 Z. WHITE	VIS TSPEI PG DIN 7991 CL 10.9 M 8 X 35 GALVANISATION BLANCHE	SCHRAUBE	TORNILLO
BV252	BV025200	NR	VITE TE TUTTO FILETTO PG DIN 933 CL 10.9 M 12 X 40 Z.D.BIANCA	SCREW ALL THREAD DIN 933 PG CL 10.9 M 12 X 40 ZD WHITE	VIS ENTIÈREMENT FILETÉE DIN 933 CL 10.9 M 12 X 40 GALVANISATION BLANCHE	SCHRAUBE	TORNILLO
BV253	BV025300	NR	VITE TBEI PG ISO 7380 M 6 X 55 Z.BIANCA	HEX SOCKET SCREW ISO 7380 PG M 6 X 55 Z. WHITE	VIS ISO 7380 PG M 6 X 55 Z. BLANC	SCHRAUBE ISO 7380 PG M 6 X 55 Z. WEIß	TORNILLO TBEI PG ISO 7380 M 6 X 55 GALVANIZADO BLANCO
BV254	BV025400	NR	VITE TE TUTTO FILETTO PG DIN 933 CL 10.9 M 10 X 35 Z.D.BIANCA	SCREW ALL THREAD DIN 933 PG CL 10.9 M 10 X 35 ZD WHITE	VIS ENTIÈREMENT FILETÉE DIN 933 CL 10.9 M 10 X 35 GALVANISATION BLANCHE	SCHRAUBE	TORNILLO
BV255	BV025500	NR	VITE TE TUTTO FILETTO PG DIN 933 CL 12.9 M 14 X 55 Z.D.BIANCA	SCREW ALL THREAD DIN 933 PG CL 12.9 M 14 X 55 ZD WHITE	VIS ENTIÈREMENT FILETÉE DIN 933 CL 12.9 M 14 X 55 GALVANISATION BLANCHE	SCHRAUBE	TORNILLO
BV256	BV025600	NR	VITE TESTA SVASATA CROCE AUTOFILETTANTE 6 X 25	SCREW HEAD CROSS COUNTERSUNK SELF TAPPING 6 X 25			
BV257	BV025700	NR	VITE TE TUTTO FILETTO PG DIN 933 CL 8.8 M14 X 30 Z.BIANCA	SCREW ALL THREAD DIN 933 PG CL 8.8 M14 X 30 Z. WHITE	VIS ENTIÈREMENT FILETÉE DIN 933 PG CL 8.8 M14 X 30 Z. BLANC	VOLLGEWINDESCHRAUBE DIN 933 PG CL 8.8 M14 X 30 Z. WEIß	TORNILLO TOTALMENTE ROSCADO PG DIN 933 CL 8.8 M14 X 30 GALVANIZADO BLANCO
BV258	BV025800	NR	VITE TE TUTTO FILETTO PG DIN 933 CL 10.9 M 12 X 35 Z.D.BIANCA	SCREW ALL THREAD DIN 933 PG CL 10.9 M 12 X 35 ZD WHITE	VIS ENTIÈREMENT FILETÉE DIN 933 CL 10.9 M 12 X 35 GALVANISATION BLANCHE	SCHRAUBE	TORNILLO
BV259	BV025900	NR	VITE TE TUTTO FILETTO PG DIN 933 CL 8.8 M 16 X 45 Z.BIANCA	SCREW ALL THREAD DIN 933 PG CL 8.8 M16 X 45 Z. WHITE	VIS ENTIÈREMENT FILETÉE DIN 933 PG CL 8.8 M16 X 45 Z. BLANC	VOLLGEWINDESCHRAUBE DIN 933 PG CL 8.8 M16 X 45 Z. WEIßE	VIS TOTALMENTE ROSCADO DIN 933 CL 8.8 M16 X 45 GALVANIZADO BLANCO
BV260	BV026000	NR	VITE TCEI PG DIN 912 CL 10.9 M 12 X 30 ZINCATA BIANCA	SCREW DIN 912 CL 10.9 M 12 X 30	VIS DIN 912 CL 12.9 M 10 X 30	SCHRAUBE DIN 912 CL 10.9 M 12 X 30	TORNILLO TCEI PG DIN 912 CL 10.9 M 12 X 30
BV261	BV026100	NR	VITE TCEI PG DIN 912 CL 10.9 M 12 X 20 ZINCATA BIANCA	SCREW DIN 912 CL 10.9 M 12 X 20	VIS DIN 912 CL 12.9 M 10 X 20	SCHRAUBE DIN 912 CL 10.9 M 12 X 20	TORNILLO TCEI PG DIN 912 CL 10.9 M 12 X 20

POS	Codice	U.M.	 Descrizione	 Description	 Designation	 Benennung	 Descripción
BV262	BV026200	NR	VITE TCEI PG DIN 912 CL 12.9 M14 X 35 GEOMET 321A	SCREW DIN 912 CL 12.9 M14 X 35 GEOMET 321A	VIS TCEI PG DIN 912 CL 12.9 M14 X 35 GEOMET 321A	SCHRAUBE DIN 912 CL 12.9 M14 X 35 GEOMET 321A	TORNILLO DIN 912 CL 12.9 M14 X 35 GEOMET 321A
BV263	BV026300	NR	VITE TCEI PG DIN 912 CL 12.9 M14 X 3 GEOMET 321A	SCREW DIN 912 CL 12.9 M14 X 3 GEOMET 321A	VIS TCEI PG DIN 912 CL 12.9 M14 X 3 GEOMET 321A	SCHRAUBE DIN 912 CL 12.9 M14 X 3 GEOMET 321A	TORNILLO DIN 912 CL 12.9 M14 X 30 GEOMET 321A
BV264	BV026400	NR	VITE TSPEI PG DIN 7991 CL 10.9 M 12 X 25 Z.BIANCA	TSPEI PG SCREW DIN 7991 CL 10.9 M12 X 25 Z. WHITE	VIS TSPEI PG DIN 7991 CL 10.9 M 12 X 25 GALVANISATION BLANCHE	SCHRAUBE	TORNILLO
BV265	BV026500	NR	VITE TE PARZIALE FILETTO PG DIN 931 CL 10.9 M 16 X 180 GEOMET 321A	SCREW PARTIAL THREAD DIN 931 PG CL 10.9 M 16 X 180 GEOMET 321A	VIS PARTIELLEMENT FILETÉE DIN 931 CL 10.9 M 16 X 180 GEOMET 321A	SCHRAUBE	TORNILLO
BV266	BV026600	NR	VITE TE TUTTO FILETTO PG DIN 933 CL 8.8 M8 X 10 Z.BIANCA	SCREW ALL THREAD DIN 933 PG CL 8.8 M8 X 10 Z. WHITE	VIS ENTIÈREMENT FILETÉE DIN 933 PG CL 8.8 M8 X 10 Z. BLANC	VOLLGEWINDESCHRAUBE DIN 933 PG CL 8.8 M8 X 10 Z. WEIß	TORNILLO TOTALMENTE ROSCADO PG DIN 933 CL 8.8 M8 X 10 GALVANIZADO BLANCO
BV267	BV026700	NR	VITE TCEI PG DIN 912 CL 8.8 M 12 X 40	SCREW DIN 912 CL 9.8 M 12 X 40	VIS DIN 912 CL 8.8 M 12 X 40	SCHRAUBE DIN 912 CL 8.8 M 12 X 40	TORNILLO DIN 912 CL 8.8 M 12 X 40
BV268	BV026800	NR	VITE TE PARZIALE FILETTO PG DIN 931 CL 8.8 M 12 X 140 Z.BIANCA	SCREW PARTIAL THREAD DIN 931 PG CL 8.8 M 12 X 140 Z. WHITE	VIS PARTIELLEMENT FILETÉE DIN 931 PG CL 8.8 M 12 X 140 Z. BLANC	TEILGEWINDESCHRAUBE DIN 931 PG CL 8.8 M 12 X 140 Z. WEIß	TORNILLO PARCIALMENTE ROSCADO PG DIN 931 CL 8.8 M 12 X 140 GALVANIZADO BLANCO
BV269	BV026900	NR	VITE TC CROCE PG DIN 7985 CL 4.8 M 6 X 25 Z.BIANCA	SCREW DIN 7985 CL 4.8 M 6 X 25	VIS CROIX DIN 7985 CL 4.8 M 6 X 25 GALVANISATION BLANCHE	SCHRAUBE	TORNILLO
BV270	BV027000	NR	VITE TCEI PG DIN 912 CL 8.8 M 12 X 40	SCREW DIN 912 CL 9.8 M 12 X 40	VIS DIN 912 CL 8.8 M 12 X 40	SCHRAUBE DIN 912 CL 8.8 M 12 X 40	TORNILLO DIN 912 CL 8.8 M 12 X 40
BV271	BV027100	NR	TCEI UNC ASME/ANSI B18.3 ASTM A 574 1/2 X 1"1/4 GEOMET	TCEI UNC ASME/ANSI B18.3 ASTM A 574 1/2 X 1"1/4 GEOMET	TCEI UNC ASME/ANSI B18.3 ASTM A 574 1/2 X 1"1/4 GEOMET	TCEI UNC ASME/ANSI B18.3 ASTM A 574 1/2 X 1"1/4 GEOMET	TCEI UNC ASME/ANSI B18.3 ASTM A 574 1/2 X 1"1/4 GEOMET
BV272	BV027200	NR	TCEI UNC ASME/ANSI B18.3 ASTM A 574 1/4-20 X 1"1/2 GEOMET	TCEI UNC ASME/ANSI B18.3 ASTM A 574 1/4-20 X 1"1/2 GEOMET	TCEI UNC ASME/ANSI B18.3 ASTM A 574 1/4-20 X 1"1/2 GEOMET	TCEI UNC ASME/ANSI B18.3 ASTM A 574 1/4-20 X 1"1/2 GEOMET	TCEI UNC ASME/ANSI B18.3 ASTM A 574 1/4-20 X 1"1/2 GEOMET
BV273	BV027300	NR	VITE TE PARZIALE FILETTO PG DIN 931 CL 8.8 M 12 X 70 Z.BIANCA	SCREW PARTIAL THREAD DIN 931 PG CL 8.8 M 12 X 70 Z. WHITE	VIS PARTIELLEMENT FILETÉE DIN 931 PG CL 8.8 M 12 X 70 Z. BLANC	TEILGEWINDESCHRAUBE DIN 931 PG CL 8.8 M 12 X 70 Z. WEIß	TORNILLO PARCIALMENTE ROSCADO PG DIN 931 CL 8.8 M 12 X 70 GALVANIZADO BLANCO

POS	Codice	U.M.	 Descrizione	 Description	 Designation	 Benennung	 Descripción
BV274	BV027400	NR	VITE TE TUTTO FILETTO PG DIN 933 CL 8.8 M 5 X 20 Z.D.BIANCA	SCREW ALL THREAD DIN 933 PG CL 8.8 M 5 X 20 ZD WHITE	VIS ENTIÈREMENT FILETÉE DIN 933 CL 8.8 M 5 X 20 GALVANISATION BLANCHE	SCHRAUBE	TORNILLO
BV275	BV027500	NR	VITE TSPEI PG DIN 7991 CL 10.9 M 6 X 70 Z.BIANCA	TSPEI PG SCREW DIN 7991 CL 10.9 M 6 X 70 Z. WHITE	VIS DIN 7991 CL 10.9 M 6 X 70 Z. BLANC	TSPEI PG SCHRAUBE DIN 7991 CL 10.9 M 6 X 70 Z. WEIß	TORNILLO TSPEI PG DIN 7991 CL 10.9 M 6 X 70 GALVANIZADO BLANCO
BV276	BV027600	NR	VITE TCEI PG DIN 912 CL 8.8 M 5 X 14 Z.BIANCA	SCREW DIN 912 PG CL 8.8 M 5 X 14 Z. WHITE	VIS DIN 912 CL 8.8 M 5 X 14 GALVANISATION BLANCHE	SCHRAUBE	TORNILLO
BV277	BV027700	NR	VITE TBEI PG ISO 7380 CL 10.9 M 10 X 35 Z.BIANCA	HEX SOCKET SCREW ISO 7380 PG CL 10.9 M 10 X 35 Z. WHITE	VIS ISO 7380 PG CL 10.9 M 10 X 35 Z. BLANC	SCHRAUBE ISO 7380 PG CL 10.9 M 10 X 35 Z. WEIß	TORNILLO TBEI PG ISO 7380 CL 10.9 M 10 X 35 GALVANIZADO BLANCO
BV278	BV027800	NR	VITE TE PARZIALE FILETTO PG DIN 931 CL 10.9 M 16 X 60	SCREW PARTIAL THREAD DIN 931 PG CL 10.9 M 16 X 60	VIS TE PARTIELLEMENT FILETÉE PG DIN 931 CL 10.9 M 16 X 60	TEILGEWINDESCHRAUBE DIN 931 PG CL 10.9 M 16 X 60	TORNILLO PARCIALMENTE ROSCADO PG DIN 931 CL 10.9 M 16 X 60
BV279	BV027900	NR	VITE TE PARZIALE FILETTO PG DIN 931 CL 8.8 M 12 X 60 Z.BIANCA	SCREW PARTIAL THREAD DIN 931 PG CL 8.8 M 12 X 60 Z. WHITE	VIS PARTIELLEMENT FILETÉE DIN 931 PG CL 8.8 M 12 X 60 Z. BLANC	TEILGEWINDESCHRAUBE DIN 931 PG CL 8.8 M 12 X 60 Z. WEIß	TORNILLO PARCIALMENTE ROSCADO PG DIN 931 CL 8.8 M 12 X 60 GALVANIZADO BLANCO
BV280	BV028000	NR	VITE TE PARZIALE FILETTO PG DIN 931 CL 8.8 M 12 X 55 Z.BIANCA	SCREW PARTIAL THREAD DIN 931 PG CL 8.8 M 12 X 55 Z. WHITE	VIS PARTIELLEMENT FILETÉE DIN 931 PG CL 8.8 M 12 X 55 Z. BLANC	TEILGEWINDESCHRAUBE DIN 931 PG CL 8.8 M 12 X 55 Z. WEIß	TORNILLO PARCIALMENTE ROSCADO PG DIN 931 CL 8.8 M 12 X 55 GALVANIZADO BLANCO
BV281	BV028100	NR	VITE TE PARZIALE FILETTO PG DIN 931 CL 8.8 M 14 X 45 Z.BIANCA	SCREW PARTIAL THREAD DIN 931 PG CL 8.8 M 14 X 45 Z. WHITE	VIS PARTIELLEMENT FILETÉE DIN 931 PG CL 8.8 M 14 X 45 Z. BLANC	TEILGEWINDESCHRAUBE DIN 931 PG CL 8.8 M 14 X 45 Z. WEIß	TORNILLO PARCIALMENTE ROSCADO PG DIN 931 CL 8.8 M 14 X 45 GALVANIZADO BLANCO
BV282	BV028200	NR	VITE TE TUTTO FILETTO PG DIN 933 CL 8.8 M 8 X 55 Z.BIANCA	SCREW ALL THREAD DIN 933 PG CL 8.8 M 8 X 55 Z. WHITE	VIS TE ENTIÈREMENT FILETÉE PG DIN 933 CL 8.8 M 8 X 55 Z.BLANC	VOLLGEWINDESCHRAUBE DIN 933 PG CL 8.8 M 8 X 55 Z. WEIß	TORNILLO TOTALMENTE ROSCADO PG DIN 933 CL 8.8 M 8 X 55 GALVANIZADO BLANCO
BV283	BV028300	NR	VITE TCEI INTERAMENTE FILETTATA PG CL 8.8 M 8 X 45 Z.BIANCA	SCREW TCEI FULLY THREADED PG CL 8.8 M 8 X 45 Z. WHITE	VIS	SCHRAUBE	TORNILLO
BV284	BV028400	NR	VITE TCEI PG DIN 912 CL 8.8 M 4 X 35 Z.BIANCA	SCREW TCEI DIN 912 CL 8.8 M 4 X 35 Z. WHITE	VIS	SCHRAUBE	TORNILLO





POS	Codice	U.M.	 Descrizione	 Description	 Designation	 Benennung	 Descripción
BV285	BV028500	NR	VITE TCEI PG DIN 912 CL 8.8 M 4 X 50 Z.BIANCA	SCREW TCEI DIN 912 CL 8.8 M 4 X 50 Z. WHITE	VIS	SCHRAUBE	TORNILLO
BV286	BV028600	NR	VITE TCEI PG DIN 912 CL 8.8 M 5 X 25 Z.BIANCA	SCREW TCEI DIN 912 CL 8.8 M 5 X 25 Z. WHITE	VIS	SCHRAUBE	TORNILLO
BV287	BV028700	NR	VITE TCEI PG DIN 912 CL 8.8 M 5 X 50 GEO 321 A	SCREW TCEI DIN 912 CL 8.8 M 5 X 50 GEO 321 A	VIS	SCHRAUBE	TORNILLO
BV293	BV029300	NR	VITE TCEI PG DIN 912 CL 8.8 M 8 X 90 Z.BIANCA	SCREW TCEI DIN 912 CL 8.8 M 8 X 90 Z. WHITE	VIS	SCHRAUBE	TORNILLO
BV294	BV029400	NR	VITE TCEI PG DIN 912 CL 8.8 M 10 X 16 Z.BIANCA	SCREW TCEI DIN 912 CL 8.8 M 10 X 16 Z. WHITE	VIS	SCHRAUBE	TORNILLO
BV295	BV029500	NR	VITE TCEI PG DIN 912 CL 8.8 M 10 X 20 Z.BIANCA	SCREW TCEI DIN 912 CL 8.8 M 10 X 20 Z. WHITE	VIS	SCHRAUBE	TORNILLO
BV297	BV029700	NR	VITE TCEI PG DIN 912 CL 8.8 M 10 X 40 Z.BIANCA	SCREW TCEI DIN 912 CL 8.8 M 10 X 40 Z. WHITE	VIS	SCHRAUBE	TORNILLO
BV298	BV029800	NR	VITE TCEI PG DIN 912 CL 8.8 M 10 X 65 Z.BIANCA	SCREW TCEI DIN 912 CL 8.8 M 10 X 65 Z. WHITE	VIS	SCHRAUBE	TORNILLO
BV299	BV029900	NR	VITE TCEI PG DIN 912 CL 8.8 M 10 X 120 Z.BIANCA	SCREW TCEI DIN 912 CL 8.8 M 10 X 120 Z. WHITE	VIS	SCHRAUBE	TORNILLO
BV300	BV030000	NR	VITE TCEI PG DIN 912 CL 8.8 M 12 X 30 Z.BIANCA	VITE TCEI PG DIN 912 CL 8.8 M 12 X 30 Z.BIANCA	VIS	SCHRAUBE	TORNILLO
BV301	BV030100	NR	VITE TCEI UNC ASME/ANSI B18.3 ASTM A 574 1/4 X 1"3/4	TCEI SCREW UNC ASME / ANSI B18.3 ASTM A 574 1/4 X 1 "3/4	VIS	SCHRAUBE	TORNILLO
BV303	BV030300	NR	VITE TCEI UNC ASME/ANSI B18.3 ASTM A 574 5/16 X 3/4	TCEI SCREW UNC ASME / ANSI B18.3 ASTM A 574 5/16 X 3/4	VIS	SCHRAUBE	TORNILLO
BV304	BV030400	NR	VITE TCEI PG DIN 912 CL 12.9 M 10 X 75	SCREW TCEI DIN 912 CL 12.9 M 10 X 75	VIS	SCHRAUBE	TORNILLO
BV305	BV030500	NR	VITE TCEI PG DIN 912 CL 12.9 M 14 X 55	SCREW TCEI DIN 912 CL 12.9 M 14 X 55	VIS	SCHRAUBE	TORNILLO
BV306	BV030600	NR	VITE TCEI BASSA PG DIN 7984 CL 10.9 M 12 X 20 Z.D.BIANCA	LOW TCEI SCREW DIN 7984 CL 10.9 M 12 X 20 Z.D. WHITE	VIS	SCHRAUBE	TORNILLO







POS	Codice	U.M.	 Descrizione	 Description	 Designation	 Benennung	 Descripción
BV307	BV030700	NR	VITE TSPEI TUTTO FILETTO PG DIN 7991 CL 10.9 M 12 X 90 ZIC. BIANCO DEID.	TSPEI SCREW FULLY THREADED DIN 7991 CL 10.9 M 12 X 90 ZIC. DEID WHITE.	VIS	SCHRAUBE	TORNILLO
BV308	BV030800	NR	VITE TSPEI TUTTO FIL. PG DIN 7991 CL 10.9 M 14 X 100 ZIC. BIANCO DEID.	TSPEI SCREW ALL THREAD DIN 7991 CL 10.9 M 14 X 100 ZIC. DEID WHITE.	VIS	SCHRAUBE	TORNILLO
BV309	BV030900	NR	VITE TSPEI PG DIN 7991 CL 10.9 M 4 X 25 ZIC. BIANCO DEID.	SCREW TSPEI DIN 7991 CL 10.9 M 4 X 25 ZIC. DEID WHITE.	VIS	SCHRAUBE	TORNILLO
BV310	BV031000	NR	VITE TSPEI PG DIN 7991 CL 10.9 M 5 X 40	SCREW TSPEI DIN 7991 CL 10.9 M 5 X 40	VIS	SCHRAUBE	TORNILLO
BV311	BV031100	NR	VITE TSPEI PG DIN 7991 CL 10.9 M 5 X 80 ZIC. BIANCO DEID.	SCREW TSPEI DIN 7991 CL 10.9 M 5 X 80 ZIC. DEID WHITE.	VIS	SCHRAUBE	TORNILLO
BV312	BV031200	NR	VITE TSPEI PG DIN 7991 CL 10.9 M 8 X 20 ZIC. BIANCO DEID.	SCREW TSPEI DIN 7991 CL 10.9 M 8 X 20 ZIC. DEID WHITE.	VIS	SCHRAUBE	TORNILLO
BV313	BV031300	NR	VITE TSPEI PG DIN 7991 CL 10.9 M 16 X 50 ZIC. BIANCO DEID.	SCREW TSPEI DIN 7991 CL 10.9 M 16 X 50 ZIC. DEID WHITE.	VIS	SCHRAUBE	TORNILLO
BV315	BV031500	NR	VITE TE UNC ANSI B18.2.1 GR.5 5/8 X 3"1/2	SCREW TE UNC ANSI B18.2.1 GR.5 5/8 X 3 1/2 "	VIS	SCHRAUBE	TORNILLO
BV316	BV031600	NR	VITE TE TUTTO FILETTO PG DIN 933 CL 8.8 M 4 X 40 Z.BIANCA	ALL SCREW TE THREAD DIN 933 CL 8.8 M 4 X 40 Z. WHITE	VIS	SCHRAUBE	TORNILLO
BV317	BV031700	NR	VITE TE TUTTO FILETTO PG DIN 933 CL 8.8 M 5 X 55 Z.BIANCA	ALL SCREW TE THREAD DIN 933 CL 8.8 M 5 X 55 Z. WHITE	VIS	SCHRAUBE	TORNILLO
BV318	BV031800	NR	VITE TE TUTTO FILETTO PG DIN 933 CL 8.8 M 6 X 10 Z.BIANCA	ALL SCREW TE THREAD DIN 933 CL 8.8 M 6 X 10 Z. WHITE	VIS	SCHRAUBE	TORNILLO
BV319	BV031900	NR	VITE TE TUTTO FILETTO PG DIN 933 CL 8.8 M 6 X 50 Z.BIANCA	ALL SCREW TE THREAD DIN 933 CL 8.8 M 6 X 50 Z. WHITE	VIS	SCHRAUBE	TORNILLO
BV320	BV032000	NR	VITE TE TUTTO FILETTO PG DIN 933 CL 8.8 M 8 X 45 Z.BIANCA	ALL SCREW TE THREAD DIN 933 CL 8.8 M 8 X 45 Z. WHITE	VIS	SCHRAUBE	TORNILLO

POS	Codice	U.M.	 Descrizione	 Description	 Designation	 Benennung	 Descripción
BV321	BV032100	NR	VITE TE TUTTO FILETTO PG DIN 933 CL 8.8 M 8 X 65 Z.BIANCA	ALL SCREW TE THREAD DIN 933 CL 8.8 M 8 X 65 Z. WHITE	VIS	SCHRAUBE	TORNILLO
BV322	BV032200	NR	VITE TE TUTTO FILETTO PG DIN 933 CL 8.8 M 8 X 80 Z.BIANCA	ALL SCREW TE THREAD DIN 933 CL 8.8 M 8 X 80 Z. WHITE	VIS	SCHRAUBE	TORNILLO
BV323	BV032300	NR	VITE TE TUTTO FILETTO PG DIN 933 CL 8.8 M 10 X 75 Z.BIANCA	ALL SCREW TE THREAD DIN 933 CL 8.8 M 10 X 75 Z. WHITE	VIS	SCHRAUBE	TORNILLO
BV324	BV032400	NR	VITE TE TUTTO FILETTO PG DIN 933 CL 8.8 M 12 X 75 Z.BIANCA	ALL SCREW TE THREAD DIN 933 CL 8.8 M 12 X 75 Z. WHITE	VIS	SCHRAUBE	TORNILLO
BV326	BV032600	NR	VITE TE PARZIALE FILETTO PG DIN 931 CL 8.8 M 8 X 90 Z.BIANCA	SCREW TE PARTIAL THREAD DIN 931 CL 8.8 M 8 X 90 Z. WHITE	VIS	SCHRAUBE	TORNILLO
BV327	BV032700	NR	VITE TE PARZIALE FILETTO PG DIN 931 CL 8.8 M 8 X 100 Z.BIANCA	SCREW TE PARTIAL THREAD DIN 931 CL 8.8 M 8 X 100 Z. WHITE	VIS	SCHRAUBE	TORNILLO
BV329	BV032900	NR	VITE TE PARZIALE FILETTO PG DIN 931 CL 8.8 M 10 X 40 Z.BIANCA	SCREW TE PARTIAL THREAD DIN 931 CL 8.8 M 10 X 40 Z. WHITE	VIS	SCHRAUBE	TORNILLO
BV330	BV033000	NR	VITE TE PARZIALE FILETTO PG DIN 931 CL 8.8 M 10 X 45 Z.BIANCA	SCREW TE PARTIAL THREAD DIN 931 CL 8.8 M 10 X 45 Z. WHITE	VIS	SCHRAUBE	TORNILLO
BV331	BV033100	NR	VITE TE PARZIALE FILETTO PG DIN 931 CL 8.8 M 10 X 60 Z.BIANCA	SCREW TE PARTIAL THREAD DIN 931 CL 8.8 M 10 X 60 Z. WHITE	VIS	SCHRAUBE	TORNILLO
BV332	BV033200	NR	VITE TE PARZIALE FILETTO PG DIN 931 CL 8.8 M 12 X 40 Z.BIANCA	SCREW TE PARTIAL THREAD DIN 931 CL 8.8 M 12 X 40 Z. WHITE	VIS	SCHRAUBE	TORNILLO
BV333	BV033300	NR	VITE TE PARZIALE FILETTO PG DIN 931 CL 8.8 M 12 X 45 Z.BIANCA	SCREW TE PARTIAL THREAD DIN 931 CL 8.8 M 12 X 45 Z. WHITE	VIS	SCHRAUBE	TORNILLO

POS	Codice	U.M.	 Descrizione	 Description	 Designation	 Benennung	 Descripción
BV334	BV033400	NR	VITE TE PARZIALE FILETTO PG DIN 931 CL 8.8 M 12 X 50 Z.BIANCA	SCREW TE PARTIAL THREAD DIN 931 CL 8.8 M 12 X 50 Z. WHITE	VIS	SCHRAUBE	TORNILLO
BV337	BV033700	NR	VITE TE PARZIALE FILETTO PG DIN 931 CL 8.8 M 14 X 60 Z.BIANCA	SCREW TE PARTIAL THREAD DIN 931 CL 8.8 M 14 X 60 Z. WHITE	VIS	SCHRAUBE	TORNILLO
BV338	BV033800	NR	VITE TE PARZIALE FILETTO PG DIN 931 CL 8.8 M 14 X 120 Z.BIANCA	SCREW TE PARTIAL THREAD DIN 931 CL 8.8 M 14 X 120 Z. WHITE	VIS	SCHRAUBE	TORNILLO
BV339	BV033900	NR	VITE TE PARZIALE FILETTO PG DIN 931 CL 8.8 M 16 X 50 Z.BIANCA	SCREW TE PARTIAL THREAD DIN 931 CL 8.8 M 16 X 50 Z. WHITE	VIS	SCHRAUBE	TORNILLO
BV340	BV034000	NR	VITE TE PARZIALE FILETTO PG DIN 931 CL 8.8 M 16 X 65 Z.BIANCA	SCREW TE PARTIAL THREAD DIN 931 CL 8.8 M 16 X 65 Z. WHITE	VIS	SCHRAUBE	TORNILLO
BV341	BV034100	NR	VITE TE TUTTO FILETTO PF DIN 961 CL 8.8 M 8 X 1 X 35 Z.BIANCA	ALL SCREW TE THREAD DIN 961 CL 8.8 M 8 X 1 X 35 Z. WHITE	VIS	SCHRAUBE	TORNILLO
BV342	BV034200	NR	VITE TE TUTTO FILETTO PF DIN 961 CL 8.8 M 20 X 1,5 X 35 Z.BIANCO	ALL SCREW TE THREAD DIN 961 CL 8.8 M 20 X 1.5 X 35 Z. WHITE	VIS	SCHRAUBE	TORNILLO
BV344	BV034400	NR	VITE TE TUTTO FILETTO PG DIN 933 CL 10.9 M 10 X 30 Z.D.BIANCA	ALL SCREW TE THREAD DIN 933 CL 10.9 M 10 X 30 Z.D. WHITE	VIS	SCHRAUBE	TORNILLO
BV346	BV034600	NR	VITE TE TUTTO FILETTO PG DIN 933 CL 10.9 M 16 X 65 GEO 321 A	ALL SCREW TE THREAD DIN 933 CL 10.9 M 16 X 65 GEO 321 A	VIS	SCHRAUBE	TORNILLO
BV347	BV034700	NR	VITE TE PARZIALE FILETTO PG DIN 931 CL 10.9 M 12 X 40 Z.D.BIANCA	SCREW TE PARTIAL THREAD DIN 931 CL 10.9 M 12 X 40 Z.D. WHITE	VIS	SCHRAUBE	TORNILLO
BV348	BV034800	NR	VITE TE PARZIALE FILETTO PG DIN 931 CL 10.9 M 12 X 75 Z.D.BIANCA	SCREW TE PARTIAL THREAD DIN 931 CL 10.9 M 12 X 75 Z.D. WHITE	VIS	SCHRAUBE	TORNILLO

POS	Codice	U.M.	 Descrizione	 Description	 Designation	 Benennung	 Descripción
BV349	BV034900	NR	VITE TE PARZIALE FILETTO PG DIN 931 CL 10.9 M 16 X 45 Z.D.BIANCA	SCREW TE PARTIAL THREAD DIN 931 CL 10.9 M 16 X 45 Z.D. WHITE	VIS	SCHRAUBE	TORNILLO
BV350	BV035000	NR	VITE TE PARZIALE FILETTO PG DIN 931 CL 10.9 M 16 X 75 Z.D.BIANCA	SCREW TE PARTIAL THREAD DIN 931 CL 10.9 M 16 X 75 Z.D. WHITE	VIS	SCHRAUBE	TORNILLO
BV351	BV035100	NR	VITE TE PARZIALE FILETTO PG DIN 931 CL 10.9 M 16 X 180	SCREW TE PARTIAL THREAD DIN 931 CL 10.9 M 16 X 180	VIS	SCHRAUBE	TORNILLO
BV352	BV035200	NR	VITE TE PARZIALE FILETTO PG DIN 931 CL 10.9 M 16 X 230 GEO 321 A	SCREW TE PARTIAL THREAD DIN 931 CL 10.9 M 16 X 230 GEO 321 A	VIS	SCHRAUBE	TORNILLO
BV354	BV035400	NR	VITE TE TUTTO FILETTO PF DIN 961 CL 10.9 M 12 X 1,25 X 35 Z.D.BIANCA	ALL SCREW TE THREAD DIN 961 CL 10.9 M 12 X 1.25 X 35 Z.D. WHITE	VIS	SCHRAUBE	TORNILLO
BV355	BV035500	NR	VITE TC CROCE PG DIN 7985 CL 4.8 M 4 X 10 Z.BIANCA	SCREW TC DIN 7985 CROSS CL 4.8 M 4 X 10 Z. WHITE	VIS	SCHRAUBE	TORNILLO
BV356	BV035600	NR	VITE TC CROCE PG DIN 7985 CL 4.8 M 5 X 22 Z.BIANCA	SCREW TC DIN 7985 CROSS CL 4.8 M 5 X 22 Z. WHITE	VIS	SCHRAUBE	TORNILLO
BV359	BV035900	NR	VITE TE 8.8 ZINCATE M 6 X 65 PARZIALE	SCREW TE 8.8 GALVANIZED M 6 X 65 PARTIAL	VIS	SCHRAUBE	TORNILLO
BV360	BV036000	NR	VITE TE 8.8 ZINCATE M 14 X 65 PARZIALE	SCREW TE 8.8 GALVANIZED M 14 X 65 PARTIAL	VIS	SCHRAUBE	TORNILLO
BV361	BV036100	NR	VITE TBEI PG ISO 7380 CL 10.9 M 5 X 20 Z.BIANCA	HEX SOCKET SCREW ISO 7380 PG CL 10.9 M 5 X 20 Z. WHITE	VIS ISO 7380 CL 10.9 M 5 X 20 GALVANISATION BLANCHE	SCHRAUBE	TORNILLO
BV362	BV036200	NR	VITE TSPEI PG DIN 7991 CL 10.9 M 6 X 35 Z.BIANCA	SCREW DIN 7991 CL 10.9 M 6 X 35 Z. WHITE			
BV363	BV036300	NR	VITE TC CROCE PG DIN 7985 CL 4.8 M 6 X 12 Z.BIANCA	CROSS HEAD SCREW DIN 7985 PG CL 4.8 M 6 X 12 Z. WHITE	VIS DIN 7985 CL 4.8 M 6 X 12 GALVANISATION BLANCHE	SCHRAUBE	TORNILLO
BV364	BV036400	NR	VITE TE PARZIALE FILETTO PG DIN 931 CL 10.9 M 16 X 160	SCREW PARTIAL THREAD DIN 931 PG CL 10.9 M 16 X 160	VIS TE PARTIELLEMENT FILETÉE PG DIN 931 CL 10.9 M 16 X 60	TEILGEWINDESCHRAUBE DIN 931 PG CL 10.9 M 16 X 160	TORNILLO PARCIALMENTE ROSCADO PG DIN 931 CL 10.9 M 16 X 160

POS	Codice	U.M.	 Descrizione	 Description	 Designation	 Benennung	 Descripción
BV365	BV036500	NR	VITE TSPEI PG DIN 7991 CL 10.9 M 10 X 25 Z.BIANCA	TSPEI PG SCREW DIN 7991 CL 10.9 M 10 X 25 Z. WHITE	VIS DIN 7991 CL 10.9 M 10 X 25 GALVANISATION BLANCHE	SCHRAUBE	TORNILLO
BV366	BV036600	NR	VITE TE TUTTO FILETTO PF DIN 961 CL 8.8 M 20 X 1,5 X 35 Z.BIANCO	ALL SCREW TE THREAD DIN 961 CL 8.8 M 20 X 1.5 X 35 Z. WHITE	VIS	SCHRAUBE	TORNILLO
BV367	BV036700	NR	VITE TE PARZIALE FILETTO PG DIN 931 CL 10.9 M 16 X 120	SCREW PARTIAL THREAD DIN 931 PG CL 10.9 M 16 X 120	VIS PARTIELLEMENT FILETÉE DIN 931 CL 10.9 M 16 X 120	SCHRAUBE	TORNILLO
BV368	BV036800	NR	VITE TSPEI PG DIN 7991 CL 10.9 M 8 X 16 Z.BIANCA	SCREW DIN 7991 CL 10.9 M 8 X 16 Z. WHITE	VIS DIN 7991 CL 10.9 M 8 X 16 GALVANISATION BLANCHE		
BV369	BV036900	NR	VITE TE PARZIALE FILETTO PG DIN 931 CL 8.8 M 6 X 90 Z.BIANCA	SCREW THREAD DIN 931 PG CL 8.8 M 6 X 90 Z. WHITE	VIS FILETÉE DIN 931 CL 8.8 M 6 X 90 GALVANISÉE BLANCHE	VOLLGEWINDESCHRAUBE DIN 931 PG CL 8.8 M 6 X 90 Z. WEIß	TORNILLO ROSCADO DIN 931 CL 8.8 M 6 X 90 GALVANIZADO BLANCO
BV370	BV037000	NR	VITE TBEI PG ISO 7380 CL 10.9 M 8 X 30 Z.BIANCA	HEX SOCKET SCREW ISO 7380 PG CL 10.9 M 8 X 30 Z. WHITE	VIS ISO 7380 PG CL 10.9 M 8 X 30 Z. BLANC	TBEI PG SCHRAUBE ISO 7380 CL 10.9 M 8 X 30 Z. WEIß	TORNILLO TBEI PG ISO 7380 CL 10.9 M 8 X 30 GALVANIZADO BLANCO
BV371	BV037100	NR	VITE TE TUTTO FILETTO PG DIN 933 CL 8.8 M 5 X 30 Z.BIANCA	SCREW ALL THREAD DIN 933 PG CL 8.8 M 5 X 30 Z. WHITE	VIS TE ENTIÈREMENT FILETÉE PG DIN 933 CL 8.8 M 5 X 30 Z.BLANC	VOLLGEWINDESCHRAUBE DIN 933 PG CL 8.8 M 5 X 30 Z. WEIß	TORNILLO TOTALMENTE ROSCADO PG DIN 933 CL 8.8 M 5 X 30 GALVANIZADO BLANCO
BV372	BV037200	NR	VITE TE TUTTO FILETTO PG DIN 933 CL 8.8 M 5 X 35 Z.BIANCA	SCREW ALL THREAD DIN 933 PG CL 8.8 M 5 X 35 Z. WHITE	VIS TE ENTIÈREMENT FILETÉE PG DIN 933 CL 8.8 M 5 X 35 Z.BLANC	VOLLGEWINDESCHRAUBE DIN 933 PG CL 8.8 M 5 X 35 Z. WEIß	TORNILLO TOTALMENTE ROSCADO PG DIN 933 CL 8.8 M 5 X 35 GALVANIZADO BLANCO
BV373	BV037300	NR	VITE TSPEI PG DIN 7991 CL 10.9 M 5 X 10 Z.BIANCA	TSPEI PG SCREW DIN 7991 CL 10.9 M 5 X 10 Z. WHITE	VIS DIN 7991 CL 10.9 M 5 X 10 GALVANISATION BLANCHE	SCHRAUBE	TORNILLO
BV374	BV037400	NR	VITE TE TUTTO FILETTO PG DIN 931 CL 8.8 M 20 X 130 Z.BIANCA	SCREW THREAD DIN 931 PG CL 8.8 M 20 X 130	VIS FILETÉE DIN 931 CL 8.8 M 20 X 130	SCHRAUBE	TORNILLO
BV375	BV037500	NR	VITE TSPEI PG DIN 7991 CL 10.9 M 8 X 120 Z.BIANCA	SCREW DIN 7991 CL 10.9 M 8 X 120 Z. WHITE	VIS DIN 7991 CL 10.9 M 8 X 120 GALVANISATION BLANCHE		
BV376	BV037600	NR	VITE TCEI PARZIALE FILETTO PG DIN 912 CL 8.8 M 6 X 65 Z.BIANCA	SCREW DIN 912 M6 X 65 CL 8.8 Z. WHITE	VIS DIN 912 CL 8.8 M 6 X 65 GALVANISATION BLANCHE	SCHRAUBE	TORNILLO









Viteria













Fasteners







POS	Codice	U.M.	Descrizione	Description	Designation	Benennung	Descripción
BV377	BV037700	NR	VITE TCEI PARZIALE FILETTO PG DIN 912 CL 8.8 M 6 X 85 Z.BIANCA	SCREW DIN 912 M6 X 85 CL 8.8 Z. WHITE	VIS DIN 912 CL 8.8 M 6 X 85 GALVANISATION BLANCHE	SCHRAUBE	TORNILLO
BV378	BV037800	NR	VITE TE TUTTO FILETTO PG DIN 933 INOX A2 M 4 X 25	SCREW ALL THREAD DIN 933 PG CL 8.8 M 4 X 25 INOX	VIS ENTièrement FILETÉE DIN 933 CL 8.8 M 4 X 25 INOX	SCHRAUBE	TORNILLO
BV379	BV037900	NR	VITE TBEI PG ISO 7380 CL 10.9 M 5 X 10 Z.BIANCA	HEX SOCKET SCREW ISO 7380 PG CL 10.9 M 5 X 10 Z. WHITE	VIS ISO 7380 CL 10.9 M 5 X 10 GALVANISATION BLANCHE	SCHRAUBE	TORNILLO





POS	Codice	U.M.	 Descrizione	 Description	 Designation	 Benennung	 Descripción
RB1	RB000100	NR	DADO PER OGIVA Ø=12	NUT FOR OGIVA Ø = 12	ÉCROU POUR OGIVE Ø=12	SCHRAUBENMUTTER FÜR OGIVA Ø = 12	TUERCA PARA OJIVA Ø=12
RD1	RD000100	NR	RACCORDO CORPO A "T" EO F(DKOL)-M-M 8L	FITTING BODY A "T" EO F (DKOL) M-M-8L	RACCORD CORP "T" EO F (DKOL) M-M-8L	T-ANSCHLUSSTÜCK EO F (DKOL) M-M-8L	UNIÓN EN "T" EO F(DKOL)-M-M 8L
RD2	RD000200	NR	RACCORDO CORPO A "T" EO F(DKOL)-M-M 10L	FITTING BODY A "T" EO F (DKOL) M-M-10L	RACCORD EN "T" EO F(DKOL)-M-M 10L	ANSCHLUSS	CONEXION
RD3	RD000300	NR	RACCORDO CORPO A "T" EO F(DKOL)-M-M 12L	FITTING BODY A "T" EO F (DKOL) M-M-12L	RACCORD CORP "T" EO F(DKOL)-M-M 12L	T-ANSCHLUSSTÜCK EO F (DKOL) M-M-12L	UNIÓN EN "T" EO F(DKOL)-M-M 12L
RD4	RD000400	NR	RACCORDO CORPO A "T" EO F(DKOL)-M-M 15L	FITTING BODY A "T" EO F (DKOL) M-M-15L	RACCORD CORPS EN "T" EO F(DKOL)-M-M 15L	T-ANSCHLUSSTÜCK EO F (DKOL) M-M-15L	UNIÓN EN "T" EO F(DKOL)-M-M 15L
RD5	RD000500	NR	RACCORDO CORPO A "T" EO M-F(DKOL)-M 10L	FITTING BODY A "T" EO M-F (DKOL) M-10L	RACCORD CORPS EN "T" EO M-F (DKOL) M-10L	T-ANSCHLUSSTÜCK EO M-F (DKOL) M-10L	UNIÓN EN "T" EO M-F(DKOL)-M 10L
RD6	RD000600	NR	RACCORDO CORPO A "T" EO M-F(DKOL)-M 12L	FITTING BODY A "T" EO M-F (DKOL) M-12L	RACCORD EN "T" EO M-F(DKOL)-M 12L	ANSCHLUSS	CONEXION
RD7	RD000700	NR	RACCORDO CORPO A "T" EO 8L M 14*1.5	FITTING BODY A "T" EO 8L M 14 * 1.5	RACCORD EN "T" EO 8L M 14*1.5	ANSCHLUSS	CONEXION
RD8	RD000800	NR	RACCORDO CORPO A "T" EO 10L M 16*1.5	FITTING BODY A "T" M 10L EO 16 * 1.5	RACCORD EN "T" EO 10L M 16*1.5	ANSCHLUSS	CONEXION
RD9	RD000900	NR	RACCORDO CORPO A "T" EO 28L M 36*2	FITTING BODY A "T" M 28L EO 36 * 2	RACCORD CORPS EN "T" M 28L EO 36 * 2	T-ANSCHLUSSTÜCK M 28L EO 36 * 2	UNIÓN EN "T" EO 28L M 36*2
RD10	RD001000	NR	RACCORDO CORPO A "T" EO 28L M 36*2	FITTING BODY A "T" EO M-F (DKOL) M-10L	RACCORD CORPS EN "T" EO M-F (DKOL) M-10L	T-ANSCHLUSSTÜCK EO M-F (DKOL) M-10L	UNIÓN EN "T" EO 28L M 36*2
RD11	RD001100	NR	RACCORDO CORPO A "T" EO M-F(DKOL)-M 10L	FITTING BODY A "T" EO M-F (DKOL) M-10L	RACCORD CORP EN "T" EO 28L M 36*2	T-ANSCHLUSSTÜCK EO M-F (DKOL) M-10L	CUERPO EN "T" CODO EO M-F(DKOL)-M 10L
RD12	RD001200	NR	ADATTATORE "T" GAS M-FG-M 1/4 1/4 1/4	ADAPTOR	ADAPTATEUR	ADAPTER	ADAPTADOR
RG1	RG000100	NR	RACCORDO CORPO A GOMITO 10L MASCH.-FEMM. DKOL	ELBOW FITTING BODY 10L MASCH.-FEMM. DKOL	RACCORD CORPS À GENOUILLÈRE 10L MASCH.-FEMM. DKOL	WINKELSTÜCK	UNIÓN EN CODO 10L MACHO-HEMBRA DKOL
RG2	RG000200	NR	RACCORDO CORPO A GOMITO 12L MASCH.-FEMM. DKOL	ELBOW FITTING BODY 12L MASCH.-FEMM. DKOL	RACCORD COUDÉ 12L MÂLE-FEMELLE DKOL	ANSCHLUSS	CONEXION





POS	Codice	U.M.	 Descrizione	 Description	 Designation	 Benennung	 Descripción
RG3	RG000300	NR	RACCORDO CORPO A GOMITO 20S MASCHIO-FEMMINA DKOS	20S BODY FITTING ELBOW MALE-FEMALE DKOS	RACCORD À GENOUILLE 20S MÂLE-FEMELLE DKOS	WINKELSTÜCK 20S STIFT- BUCHSE DKOS	UNIÓN EN CODO 20S MACHO- HEMBRA DKOS
RG4	RG000400	NR	RACCORDO CORPO A GOMITO 28L MASCHIO-FEMMINA DKOL	28L BODY FITTING ELBOW MALE-FEMALE DKOL	RACCORD CORPS À GENOUILLE MÂLE-FEMELLE DKOL	WINKELSTÜCK 28L STIFT- BUCHSE DKOL	UNIÓN EN CODO 28L MACHO- HEMBRA DKOL
RG5	RG000500	NR	RACCORDO A L MASCHIO- FEMMINA 1/8	BODY 90 ° M / F 1/8 "			
RG6	RG000600	NR	ADATTATORE 90° BSPP M-FG 1/4	ADAPTOR	ADAPTATEUR	ADAPTER	ADAPTADOR
RN1	RN000100	NR	RACCORDO CORPO D'ESTREMITA' TENUTA ED 8L * 3/8 GAS *K*	END FITTING WITH SEAL ED 8L * 3/8 GAS * K *	RACCORD CORPS D'EXTRÉMITÉ AVEC JOINT ED 8L * 3/8 GAS *K*	ANSCHLUSSSTÜCK MIT DICHTUNG ED 8L * 3/8 GAS * K *	UNIÓN CON JUNTA ED 8L * 3/8 GAS *K*
RN2	RN000200	NR	RACCORDO CORPO D'ESTREMITA' TENUTA ED 12L * 3/8 GAS *K*	END FITTING WITH SEAL ED 12L * 3/8 GAS * K *	RACCORD CORPS D'EXTRÉMITÉ AVEC JOINT ED12L * 3/8 GAS *K*	ANSCHLUSSSTÜCK MIT DICHTUNG ED 12L * 3/8 GAS * K *	UNIÓN CON JUNTA ED 12L * 3/8 GAS *K*
RN3	RN000300	NR	RACCORDO CORPO D'ESTREMITA' TENUTA ED 10L * 3/8 GAS *K*	FITTING END OF BODY 'AND SEAL 10L * 3/8 GAS * K *	RACCORD D'EXTRÉMITÉ AVEC JOINT D'ÉTANCHÉITÉ 10L * 3/8 GAS *K*	ANSCHLUSS	CONEXION
RN4	RN000400	NR	RACCORDO CORPO D'ESTREMITA' TENUTA ED 8L * 1/4 GAS *K*	END FITTING WITH SEAL ED 8L * 1/4 GAS * K *	RACCORD CORPS D'EXTRÉMITÉ AVEC JOINT ED 8L * 1/4 GAS *K*	ANSCHLUSSSTÜCK MIT DICHTUNG ED 8L * 1/4 GAS * K *	UNIÓN CON JUNTA ED 8L * 1/4 GAS *K*
RN5	RN000500	NR	RACCORDO CORPO D'ESTREMITA' TENUTA ED 10L * 1/4 GAS *K*	FITTING END OF BODY 'AND SEAL 10L * 1/4 GAS * K *	RACCORD D'EXTRÉMITÉ AVEC JOINT D'ÉTANCHÉITÉ 10L * 1/4 GAS *K*	ANSCHLUSS	CONEXION
RN6	RN000600	NR	RACCORDO CORPO D'ESTREMITA' TENUTA ED 12L * 1/4 GAS	FITTING END OF BODY 'AND SEAL 12L * 1/4 GAS	RACCORD	ANSCHLUSS	CONEXION
RN7	RN000700	NR	RACCORDO NIPLES GAS CON.- GAS CON. 1/4" * 1/4"	FITTING	RACCORD	ANSCHLUSS	RACORD
RN8	RN000800	NR	RACCORDO CORPO D'ESTREMITA' TENUTA ED 15L * 1/2 GAS *K*	END FITTING WITH SEAL ED 15L * 1/2 * K * GAS	RACCORD CORPS D'EXTRÉMITÉ AVEC JOINT ED 15L * 1/2 GAS *K*	ANSCHLUSSSTÜCK MIT DICHTUNG ED 15L * 1/2 GAS *K*	UNIÓN CON JUNTA ED 15L * 1/2 GAS *K*





POS	Codice	U.M.	 Descrizione	 Description	 Designation	 Benennung	 Descripción
RN9	RN000900	NR	RACCORDO CORPO D'ESTREMITA' TENUTA ED 10L * 1/2 GAS *K*	FITTING END OF BODY 'AND SEAL 10L * 1/2 * K * GAS	RACCORD	ANSCHLUSS	CONEXION
RN10	RN001000	NR	RACCORDO CORPO D'ESTREMITA' TENUTA ED 15L * 3/4 GAS *K*	END FITTING WITH SEAL ED 15L * 3/4 GAS * K *	RACCORD CORPS D'EXTRÉMITÉ AVEC JOINT ED 15L * 3/4 GAS * K *	ANSCHLUSSSTÜCK MIT DICHTUNG ED 15L * 3/4 GAS *K*	UNIÓN CON JUNTA ED 15L * 3/4 GAS *K*
RN11	RN001100	NR	RACCORDO CORPO D'ESTREMITA' TENUTA ED 12L * 1/2 GAS *K*	END FITTING WITH SEAL ED 12L * 1/2 GAS * K *	RACCORD CORPS D'EXTRÉMITÉ AVEC JOINT ED 12L * 1/2 GAS *K*	ANSCHLUSSSTÜCK MIT DICHTUNG ED 12L * 1/2 GAS *K*	UNIÓN CON JUNTA ED 12L * 1/2 GAS *K*
RN12	RN001200	NR	RACCORDO CORPO D'ESTR. TENUTA ED 8L * 1/2 GAS	END FITTING WITH SEAL ED 8L * 1/2 GAS	RACCORD CORP D'EXTRÉMITÉ AVEC JOINT ED 8L * 1/2 GAS	ANSCHLUSSSTÜCK MIT DICHTUNG ED 8L * 1/2 GAS	UNIÓN CON JUNTA ED 8L * 1/2 GAS
RN13	RN001300	NR	RACCORDO CORPO D'ESTR. TENUTA ED 8L * 3/4 GAS	CONNECTOR BODY OF EXTR. SEAL AND 8L * 3/4 GAS	RACCORD	ANSCHLUSS	CONEXION
RN14	RN001400	NR	RACCORDO CORPO D'ESTR. TENUTA ED 12L * 3/4 GAS	CONNECTOR BODY OF EXTR. SEAL AND 12L * 3/4 GAS	RACCORD	ANSCHLUSS	CONEXION
RN15	RN001500	NR	RACCORDO CORPO D'ESTR.TENUTA ED 15L * 3/8 GAS	END FITTING WITH SEAL ED 15L * 3/8 GAS	RACCORD CORPS D'EXTRÉMITÉ AVEC JOINT ED15L * 3/8 GAS	ANSCHLUSSSTÜCK MIT DICHTUNG ED 15L * 3/8 GAS	UNIÓN CON JUNTA ED 15L * 3/8 GAS
RN16	RN001600	NR	RACCORDO CORPO D'ESTR.TENUTA ED 22L * 3/4 GAS	END FITTING WITH SEAL ED 22L * 3/4 GAS	RACCORD CORP D'EXTRÉMITÉ AVEC JOINT ED 22L * 3/4 GAS	ANSCHLUSSSTÜCK MIT DICHTUNG ED 22L * 3/4 GAS	UNIÓN CON JUNTA ED 22L * 3/4 GAS
RN17	RN001700	NR	RACCORDO CORPO D'ESTR. TENUTA ED 28L * 3/4" GAS	END FITTING WITH SEAL ED 28L * 3/4 BSP	RACCORD CORPS D'EXTRÉMITÉ AVEC JOINT ED 28L * 3/4 BSP	ANSCHLUSSSTÜCK MIT DICHTUNG ED 28L * 3/4" GAS	UNIÓN CON JUNTA ED 28L * 3/4" GAS
RN18	RN001800	NR	RACCORDO CORPO D'ESTR. TENUTA ED 20S * 3/4 GAS	CONNECTOR BODY OF EXTR. SEAL AND 20S * 3/4 GAS	RACCORD	ANSCHLUSS	CONEXION
RN19	RN001900	NR	RACCORDO CORPO D'ESTREMITA' 8L * M 12X1.5 ED	END FITTING 8L * M 12X1.5 ED	RACCORD CORPS D'EXTRÉMITÉ 8L * M 12X1.5 ED	ANSCHLUSSSTÜCK 8L * M 12X1.5 ED	UNIÓN 8L * M 12X1.5 ED
RN20	RN002000	NR	RACCORDO CORPO D'ESTREMITA' 8L * M 14X1.5 ED	FITTING END OF BODY 'AND 8L * M 14X1.5	RACCORD	ANSCHLUSS	CONEXION

POS	Codice	U.M.	 Descrizione	 Description	 Designation	 Benennung	 Descripción
RN21	RN002100	NR	RACCORDO CORPO D'ESTREMITA' 10L * M 18X1.5 ED	END FITTING 10L * M 18X1.5	RACCORD CORPS D'EXTRÉMITÉ 10L * M 18X1.5 ED	ANSCHLUSSSTÜCK 10L * M 18X1.5 ED	UNIÓN 10L * M 18X1.5 ED
RN22	RN002200	NR	RACCORDO CORPO D'ESTR. TENUTA ED 15L * M 18X1.5	CONNECTOR BODY OF EXTR. SEAL AND 15L * M 18X1.5	RACCORD	ANSCHLUSS	CONEXION
RN23	RN002300	NR	RACCORDO CORPO D'ESTR. TENUTA ED 15L * M 22X1.5	END FITTING WIHT SEAL ED 15L * M 22X1.5	RACCORD CORPS D'EXTRÉMITÉ AVEC JOINT ED 15L * M 22X1.5	ANSCHLUSSSTÜCK MIT DICHTUNG ED 15L * M 22X1.5	UNIÓN CON JUNTA ED 15L * M 22X1.5
RN24	RN002400	NR	RACCORDO CORPO D'ESTR. TENUTA ED 22L * M26X1.5	CONNECTOR BODY OF EXTR. SEAL AND 22L * M26X1.5	RACCORD	ANSCHLUSS	CONEXION
RN25	RN002500	NR	RACCORDO CORPO D'ESTR. TENUTA ED 20S * M27X2	CONNECTOR BODY OF EXTR. SEAL AND 20S * M27X2	RACCORD	ANSCHLUSS	CONEXION
RN26	RN002600	NR	RACCORDO CORPO D'ESTR. 8L * 9/16-18 UNF-2A	END FITTING 8L * 9/16-18 UNF-2A	RACCORD CORPS D'EXTRÉMITÉ 8L * 9/16-18 UNF-2A	ANSCHLUSSSTÜCK 8L * 9/16-18 UNF-2A	UNIÓN 8L * 9/16-18 UNF-2A
RN27	RN002700	NR	RACCORDO CORPO D'ESTR. 12L * 3/4 -16 UNF-2A	END FITTING 12L * 3/4 -16 UNF-2A	RACCORD CORPS D'EXTRÉMITÉ 12L * 3/4 -16 UNF-2A	ANSCHLUSSSTÜCK 12L * 3/4 -16 UNF-2A	UNIÓN 12L * 3/4 -16 UNF-2A
RN28	RN002800	NR	RACCORDO CORPO D'ESTR. 20S * 1.5/16 -12 UN-2A	END FITTING 20S * 1.5/16 -12 UN-2A	RACCORD CORPS D'EXTRÉMITÉ 20S * 1.5/16 -12 UN-2A	ANSCHLUSSSTÜCK 20S * 1.5/16 -12 UN-2A	UNIÓN 20S * 1.5/16 -12 UN-2A
RN29	RN002900	NR	RACCORDO CORPO D'ESTR. TENUTA ED 22L * M26X1.5	END FITTING WITH SEAL ED 22L * M26X1.5	RACCORD CORPS D'EXTRÉMITÉ AVEC JOINT ED 22L * M26X1.5	ANSCHLUSSSTÜCK MIT DICHTUNG ED 22L * M26X1.5	UNIÓN CON JUNTA 22L * M26X1.5
RN30	RN003000	NR	RACCORDO CORPO D'ESTR. TENUTA ED 22L * M26X1.5	END FITTING WITH SEAL ED 22L * M26X1.5	RACCORD CORPS D'EXTRÉMITÉ AVEC JOINT ED 22L * M26X1.5	ANSCHLUSSSTÜCK MIT DICHTUNG ED 22L * M26X1.5	UNIÓN CON JUNTA ED 22L * M26X1.5
RN31	RN003100	NR	RACCORDO CORPO D'ESTREMITA' TENUTA ED 6L * 1/4 GAS *K*	END FITTING WITH SEAL 1/4 BSPP 6L	RACCORD CORPS D'EXTRÉMITÉ AVEC JOINT 1/4 BSPP 6L	ANSCHLUSSSTÜCK MIT DICHTUNG 1/4 BSPP 6L	UNIÓN CON JUNTA 1/4 BSPP 6L
RN32	RN003200	NR	RACCORDO CORPO D'ESTREMITA' TENUTA ED 8L * 3/8 GAS *K*	END FITTING WITH SEAL ED 8L * 3/8 GAS * K *	RACCORD CORPS D'EXTRÉMITÉ AVEC JOINT ED 8L * 3/8 GAS *K*	ANSCHLUSSSTÜCK MIT DICHTUNG ED 8L * 3/8 GAS * K *	UNIÓN CON JUNTA ED 8L * 3/8 GAS *K*



POS	Codice	U.M.	 Descrizione	 Description	 Designation	 Benennung	 Descripción
RN33	RN003300	NR	NIPPLES 1/8" JIS 1/8"GAS	CAP	CAPUCHON	NIPPEL	CAPUCHO
RN34	RN003400	NR	NIPPLES 1/4" JIS 1/4"GAS	CAP	CAPUCHON	NIPPEL	CAPUCHO
RN35	RN003500	NR	NIPPLES 3/8" JIS 1/4"GAS	CAP	CAPUCHON	NIPPEL	CAPUCHO
RN36	RN003600	NR	NIPPLES 3/8" JIS 1/4"GAS	CAP	CAPUCHON	NIPPEL	CAPUCHO
RO1	RO000100	NR	OGIVA PER TUBO Ø=12	OGIVE FOR TUBE Ø = 12	OGIVE POUR TUYAU Ø = 12	OGIVE FÜR ROHR Ø = 12	OJIVA PARA TUBO Ø=12
RR1	RR000100	NR	RONDELLA RAME 1/4	COPPER WASHER 1/4	RONDELLE	SCHEIBE	ARANDELA
RR2	RR000200	NR	RONDELLA BONDED GAS 3/8" *K*	BONDED WASHER GAS 3/8 " * K *	RONDELLE	SCHEIBE	ARANDELA
RR3	RR000300	NR	RONDELLA BONDED METRICA 12 *K*	METRIC BONDED WASHER 12 * K *	RONDELLE BONDED MÉTRIQUE 12 *K*	BONDED UNTERLEGSCHIEBE 12 * K *	ARANDELA BONDED MÉTRICA 12 *K*
RR4	RR000400	NR	RONDELLA BONDED GAS 1/4" *K*	BONDED WASHER GAS 1/4 " * K *	RONDELLE		
RR5	RR000500	NR	RONDELLA BONDED GAS 1/2" *K*	BONDED WASHER GAS 1/2 " * K *	RONDELLE BONDED GAS 1/2" *K*	BONDED UNTERLEGSCHIEBE GAS 1/2" *K*	ARANDELA BONDED GAS 1/2" *K*
RR6	RR000600	NR	RONDELLA RAME 3/8	COPPER WASHER 3/8	RONDELLE	SCHEIBE	ARANDELA
RR7	RR000700	NR	RONDELLA BONDED GAS 1/8" *K*	BONDED WASHER GAS 1/8 " * K *	RONDELLE	SCHEIBE	ARANDELA
RR8	RR000800	NR	RONDELLA BONDED GAS 1" *K*	BONDED WASHER GAS 1 " * K *	RONDELLE BONDED GAS 1" *K*	BONDED UNTERLEGSCHIEBE GAS 1" *K*	ARANDELA BONDED GAS 1" *K*
RR9	RR000900	NR	RONDELLA BONDED GAS 3/4" *K*	BONDED WASHER GAS 3/4 " * K *	RONDELLE BONDED GAS 3/4" *K*	BONDED UNTERLEGSCHIEBE GAS 3/4" *K*	ARANDELA BONDED GAS 3/4" *K*
RR10	RR001000	NR	RONDELLA BONDED GAS 1.1/4"	BONDED WASHER GAS 1.1 / 4 "	RONDELLE	SCHEIBE	ARANDELA
RR11	RR001100	NR	RONDELLA RAME M10	COPPER WASHER M10	RONDELLE	SCHEIBE	ARANDELA
RR12	RR001200	NR	RONDELLA RAME 1/2	COPPER WASHER 1/2	RONDELLE	SCHEIBE	ARANDELA
RR13	RR001300	NR	RONDELLA BONDED M12	BONDED WASHER M12	RONDELLE	SCHEIBE	ARANDELA
RS1	RS000100	NR	COPPIA SEMIFLANGE SAE 6000 3/4"	PAIR 6000 SAE FLANGE HALVES 3/4 "	COUPLE SEMI-BRIDES SAE 6000 3/4"	SAE-HALBFLANSCHEN PAAR 6000 3/4"	PAREJA SEMIBRIDAS SAE 6000 3/4"

POS	Codice	U.M.	 Descrizione	 Description	 Designation	 Benennung	 Descripción
RS2	RS000200	NR	RACC.M 20S(M30X2) - ED M 1"5/16 UNF H=33	FITTING M 20S (M30X2) - ED M 1 "5/16 UNF H = 33	RACCORD M 20S(M30X2) - ED M 1"5/16 UNF H=33	ANSCHLUSSSTÜCK M 20S (M30X2) - ED M 1 "5/16 UNF H = 33	UNIÓN M 20S(M30X2) - ED M 1"5/16 UNF H=33
RS3	RS000300	NR	RIDUZIONE M-F GAS 1" * 1/2"	REDUCING GAS M-F 1 " * 1/2"	RÉDUCTION M-F GAS 1" * 1/2"	REDUKTION M-F GAS 1" * 1/2"	REDUCCIÓN M-F GAS 1" * 1/2"
RS4	RS000400	NR	RACCORDO COLONNETTA M15L - 3/8" GAS H=50	COLUMN CONNECTION M15L - 3/8 "GAS H = 50	RACCORD DOIGT M15L - 3/8 "GAS H = 50	ANSCHLUSS M15L - 3/8 "GAS H = 50	CODO M15L - 3/8" GAS H=50
RS5	RS000500	NR	RACCORDO COLONNETTA M15L - 3/8" GAS H=96	COLUMN CONNECTION M15L - 3/8 "GAS H = 96	RACCORD DOIGT M15L - 3/8" GAS H=96	ANSCHLUSS - 3/8 "GAS H = 96	CODO M15L - 3/8" GAS H=96
RS6	RS000600	NR	CODOLO M1/4" ED X FG 8L (M14X1.5)	FITTING M1 / 4 "X AND FG 8L (M14X1.5)	EMBOUT M1/4" ED X FG 8L (M14X1.5)	SCHAFT M1/4" ED X FG 8L (M14X1.5)	CODO M1/4" ED X FG 8L (M14X1.5)
RS7	RS000700	NR	RIDUZIONE M-F GAS 1" * 1/2"	REDUCING GAS M-F 1 " * 1/2"	RÉDUCTION M-F GAS 1" * 1/2"	REDUZIERUNG GAS M-F 1" * 1/2"	REDUCCIÓN M-F GAS 1" * 1/2"
RS8	RS000800	NR	RACCORDO CODOLO D' ESTR. FEM. DKO 12L*3/8 GAS ED	END FITTING FEM. DKO 12L*3/8 GAS ED	RACCORD FEM. DKO 12L*3/8 GAS ED	ANSCHLUSS FEM. DKO 12L*3/8 GAS ED	CONECTOR FEM. DKO 12L*3/8 GAS ED
RS9	RS000900	NR	MANICOTTO ARIA 1/8-1/8	AIR MANIFOLD 1/8-1/8			
RS10	RS001000	NR	RIDUZIONE M-F GAS 3/8" JIS 1/8" BSPP	REDUCING GAS M-F 3/8" JIS 1/8" BSPP	RÉDUCTION M-F GAS 3/8" JIS 1/8" BSPP	REDUZIERUNG GAS M-F 3/8" JIS 1/8" BSPP	REDUCCIÓN M-F GAS 3/8" JIS 1/8" BSPP
RS11	RS001100	NR	RACCORDO M-M 15L	FITTING M-M 15L			
RS12	RS001200	NR	RACCORDO NIPLES GAS CON.- GAS CON.1/2"1/2"	FITTING 1/2" - 1/2"	RACCORD	ANSCHLUSS	RACORD
RT1	RT000100	NR	TAPPO MASCHIO TE GAS 3/8" SVASATO 60° *K*	SCREW EYE FOR GAS 1/2 "H = 50	BOUCHON	VERSCHLUSS	TAPA
RT2	RT000200	NR	TAPPO MASCHIO ESAGONO INTERNO GAS 1/4" SVASATO 60° *K*	MALE PLUG GAS INTERNAL HEX 1/4 "FLARE 60 ° * K *	BOUCHON MÂLE HEXAGONAL INTÉRIEUR GAS 1/4" ÉVASÉ 60° *K*	ZYLINDRISCHER STOPFEN	TAPÓN MACHO HEXÁGONO INTERNO GAS 1/4" SVASATO 60° *K*
RT3	RT000300	NR	TAPPO MASCHIO TE GAS 1/2" SVASATO 60° *K*	MALE PLUG TE GAS 1/2 "FLARE 60 ° * K *	BOUCHON MÂLE TE GAS 1/2" ÉVASÉ 60° *K*	STECKER TE GAS 1/2 "GESENKT 60 ° * K *	TAPÓN MACHO TE GAS 1/2" ABOCINADO 60° *K*
RT4	RT000400	NR	TAPPO MASCHIO TE GAS 1/4" SVASATO 60° *K*	MALE PLUG TE GAS 1/4 "FLARE 60 ° * K *	BOUCHON	VERSCHLUSS	TAPA
RT5	RT000500	NR	TAPPO MASCHIO ESAGONO INTERNO GAS 3/8" SVASATO 60° *K*	MALE PLUG GAS INTERNAL HEX 3/8 "FLARE 60 ° * K *	BOUCHON	VERSCHLUSS	TAPA

POS	Codice	U.M.	 Descrizione	 Description	 Designation	 Benennung	 Descripción
RT6	RT000600	NR	TAPPO MASCHIO ESAGONO INTERNO GAS 1" SVASATO 60° *K*	MALE PLUG GAS INTERNAL HEX 1 "FLARE 60 ° * K *	BOUCHON MÂLE HEXAGONAL INTÉRIEUR GAS 1" ÉVASÉ 60° *K*	ZYLINDRISCHER STOPFEN + DICHTUNG	TAPÓN MACHO HEXÁGONO INTERNO GAS 1" ABOCINADO 60° *K*
RT7	RT000700	NR	TAPPO MASCHIO TE GAS 1/8" SVASATO 60° *K*	MALE PLUG TE GAS 1/8 "FLARE 60 ° * K *	BOUCHON	VERSCHLUSS	TAPA
RT8	RT000800	NR	TAPPO MASCHIO TE GAS 1/4" JIS	MALE PLUG TE GAS 1/4 " JIS	BOUCHON	VERSCHLUSS	TAPA
RT9	RT000900	NR	TAPPOO FEMMINA COMPLETO 6L	COMPLETE 6L FEMALE CAP			
RT10	RT001000	NR	TAPPOO FEMMINA COMPLETO 8L	COMPLETE 8L FEMALE CAP	COUVERCLE	DECKEL	TAPA
RT11	RT001100	NR	TAPPO CILINDRICO TCEI+GUARNIZIONE GAS CI 5.8 3/4 Z.BIANCA	CYLINDRICAL SOCKET HEAD CAP + SEAL GAS CI 5.8 3/4 Z. WHITE	BOUCHON	VERSCHLUSS	TAPA
RT12	RT001200	NR	TAPPO CILINDRICO TCEI+GUARNIZIONE GAS CI 5.8 1/2 Z.BIANCA	CYLINDRICAL SOCKET HEAD CAP + SEAL GAS CI 5.8 1/2 Z. WHITE	BOUCHON	VERSCHLUSS	TAPA
RV1	RV000100	NR	VITE PER OCCHIO GAS 1/4" H=29 *K*	SCREW EYE FOR GAS 1/4 "H = 29 * K *	VIS	SCHRAUBE	TORNILLO
RV2	RV000200	NR	VITE PER OCCHIO DOPPIA GAS 3/8"	SCREW EYE DOUBLE FOR GAS 3/8 "	VIS	SCHRAUBE	TORNILLO
RV3	RV000300	NR	VITE PER OCCHIO GAS 1/2" H=50	SCREW EYE FOR GAS 1/2 "H = 50	VIS	SCHRAUBE	TORNILLO
RV4	RV000400	NR	VITE PER OCCHIO DOPPIA GAS 1/4"	DOUBLE EYE SCREW FOR GAS 1/4"	VIS DOUBLE À OEIL GAS 1/4"	DOPPEL-AUGENSCHRAUBE GAS 1/4"	TORNILLO DOBLE OJO GAS 1/4"
RV5	RV000500	NR	VITE PER OCCHIO GAS 3/8"	SCREW EYE FOR GAS 3/8"	VIS	SCHRAUBE	TORNILLO
RV6	RV000600	NR	VITE PER OCCHIO GAS 1/8"	SCREW EYE FOR GAS 1/8"	VIS	SCHRAUBE	TORNILLO

