



An Oshkosh Corporation Company

Illustrated Parts Manual

Compact Crawler

X15JP/1

X15JP/2



X430AJ/1



X430AJ/2

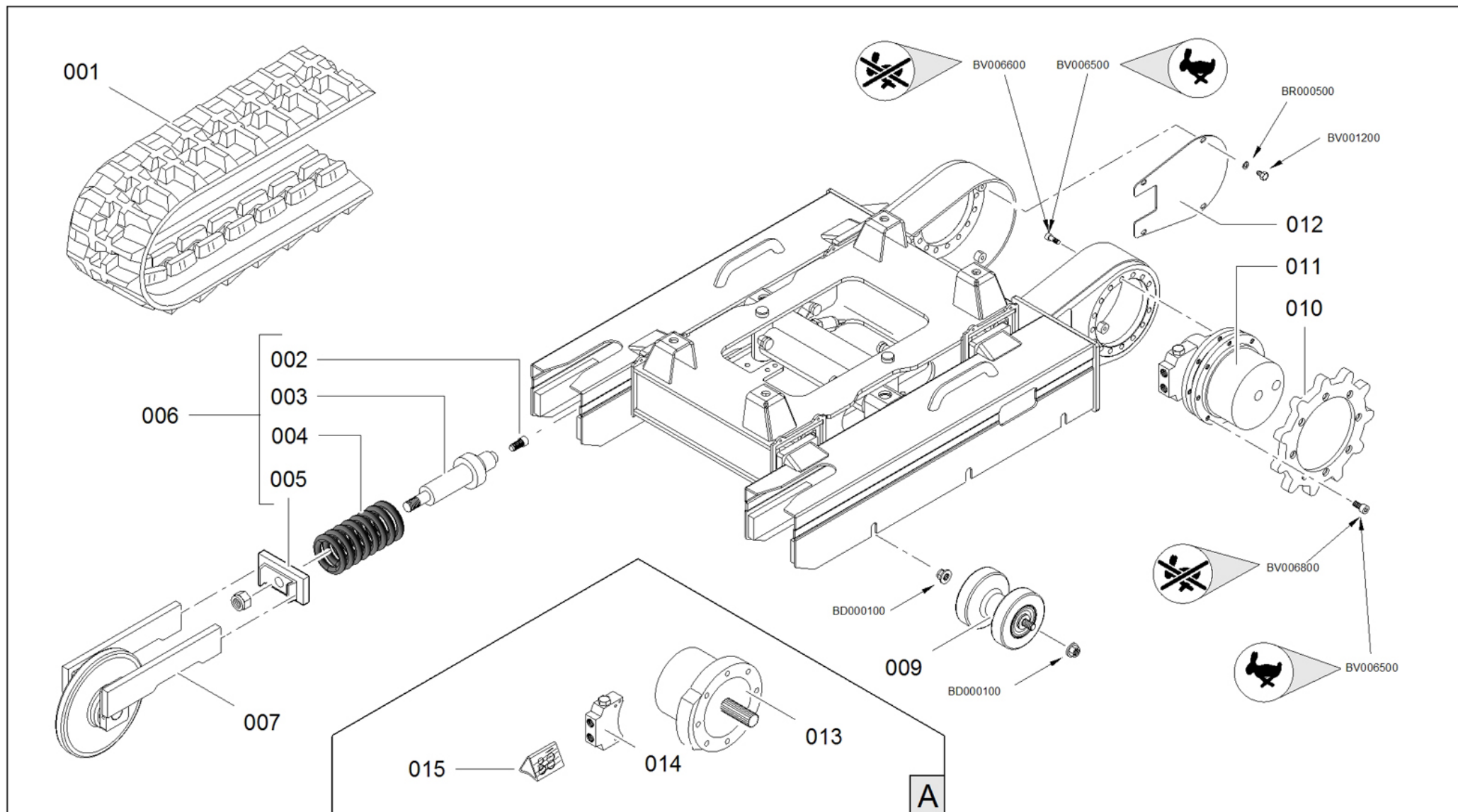









3121778
January 18, 2023 - Rev I







 SOTTOCARRO CINGOLATO
 TRACKED UNDERCARRIAGE
 CHENILLARD





 RAUPENFAHRWERK
 CARRO DE ORUGAS



POS	Codice	 Descrizione	 Description	 Designation	 Benennung	 Descripción
1	053715L0	CINGOLO IN GOMMA BASSO PROFILO NERO	RUBBER TRACK LOW PROFILE BLACK	CHENILLE EN CAOUTCHOUC	GUMMIRAUPE	ORUGA DE GOMA
1	053715LB	CINGOLO IN GOMMA BASSO PROFILO ANTITRACCIA	RUBBER TRACK LOW PROFILE NO MARKING	CHENILLE BLANCHE CAOUTCHOUC	GUMMIRAUPE	ORUGA BLANCA DE GOMA
2	03149200	VALVOLA IDRAULICA	HYDRAULIC VALVE	VALVE HYDRAULIQUE	HYDRAULIKVENTIL	VÁLVULA HIDRÁULICA
3	10681670	CILINDRO	CYLINDER	VÉRIN	ZYLINDER	CILINDRO
4	03024800	MOLLA	SPRING	RESSORT	FEDER	MUELLE
5	34719500	PIATTO	PLATE	PLATEAU	PLATTE	PLACA
6	147534Y1	SUPPORTO TENDICINGOLO	IDLER SUPPORT	SUPPORT TENDEUR CHENILLE	KETTEHSPANNER-HALTER	SOPORTE TENSOR ORUGA
7	153937A3	RUOTA TENDICINGOLO	IDLER WHEEL	ROUE TENDEUR DE CHENILLE	RAUPENSPANNRAD	RUEDA TENSOR ORUGA
7	153937H2	RUOTA TENDICINGOLO	IDLER WHEEL	ROUE TENDEUR DE CHENILLE	RAUPENSPANNRAD	RUEDA TENSOR ORUGA
9	153515A3	RULLO INFERIORE	CARRIER ROLLER	ROULEAU INFÉRIEUR	UNTERE ROLLER	RODILLO INFERIOR
9	153515H2	RULLO INFERIORE	CARRIER ROLLER	ROULEAU INFÉRIEUR	UNTERE ROLLE	RODILLO INFERIOR
10	041736A3	RUOTA DI TRAZIONE	SPROCKET WHEEL	ROUE DE TRACTION	ANTRIEBSRAD	RUEDA DE ARRASTRE
10	041736H2	RUOTA DI TRAZIONE	SPROCKET WHEEL	ROUE DE TRACTION	ANTRIEBSRAD	RUEDA DE ARRASTRE
10	055707A3	RUOTA DI TRAZIONE	SPROCKET WHEEL	ROUE DE TRACTION	ANTRIEBSRAD	RUEDA DE ARRASTRE
10	055707H2	RUOTA DI TRAZIONE	SPROCKET WHEEL	ROUE DE TRACTION	ANTRIEBSRAD	RUEDA DE ARRASTRE
11	147411A3	MOTORIDUTTORE	GEAR MOTOR	MOTORÉDUCTEUR	GETRIEBEMOTOR	MOTORREDUCTOR
11	147411H2	MOTORIDUTTORE	MOTORGearBOX	MOTORÉDUCTEUR	GETRIEBEMOTOR	MOTORREDUCTOR
11	267525A3	MOTORIDUTTORE 700C2K I:32 + MAG12 VP AUTO2SPEED CON FRENO	GEAR MOTOR 700C2K I: 32 + MAG12 VP AUTO2SPEED WITH BRAKE	MOTORÉDUCTEUR	GETRIEBEMOTOR	MOTORREDUCTOR
11	267525H2	MOTORIDUTTORE 700C2K I:32 + MAG12 VP AUTO2SPEED CON FRENO	GEAR MOTOR 700C2K I: 32 + MAG12 VP AUTO2SPEED WITH BRAKE	MOTORÉDUCTEUR	GETRIEBEMOTOR	MOTORREDUCTOR
12	053809A3	COPERCHIO	COVER	COUVERCLE	DECKEL	TAPA



Main color codes:  J1 - JLG Cream,  J2 - JLG Orange,  C4 - Green

 SOTTOCARRO CINGOLATO
 TRACKED UNDERCARRIAGE
 CHENILLARD



RAUPENFAHRWERK 
 CARRO DE ORUGAS 

POS	Codice	 Descrizione	 Description	 Designation	 Benennung	 Descripción
12	053809H2	COPERCHIO	COVER	COUVERCLE	DECKEL	TAPA
12	054868A3	COPERCHIO 2 VELOCITÀ	COVER HIGH SPEED	COUVERCLE	TAPA	DEKSEL
12	054868H2	COPERCHIO 2 VELOCITÀ	COVER HIGH SPEED	COUVERCLE	TAPA	DEKSEL
13	1474110002	MOTORE IDRAULICO	HYDRAULIC MOTOR	MOTEUR HYDRAULIQUE	HYDRAULIKMOTOR	MOTOR HIDRÁULICO
14	1450590003	VALVOLA IDRAULICA	HYDRAULIC VALVE	VALVE HYDRAULIQUE	VALVE HYDRAULIQUE	VÁLVULA HIDRÁULICA
15	1450590004	KIT GUARNIZIONI COMPLETO PER 145059NV-147411NV-15041600	SEALS COMPLETE KIT 145059 147411 NV-NV-15041600	KIT JOINTS	DICHTUNGSSATZ	KIT JUNTAS

-  ALLARGAMENTO IDRAULICO
-  HYDRAULIC EXTENSION
-  ECARTEMENT HYDRAULIQUE

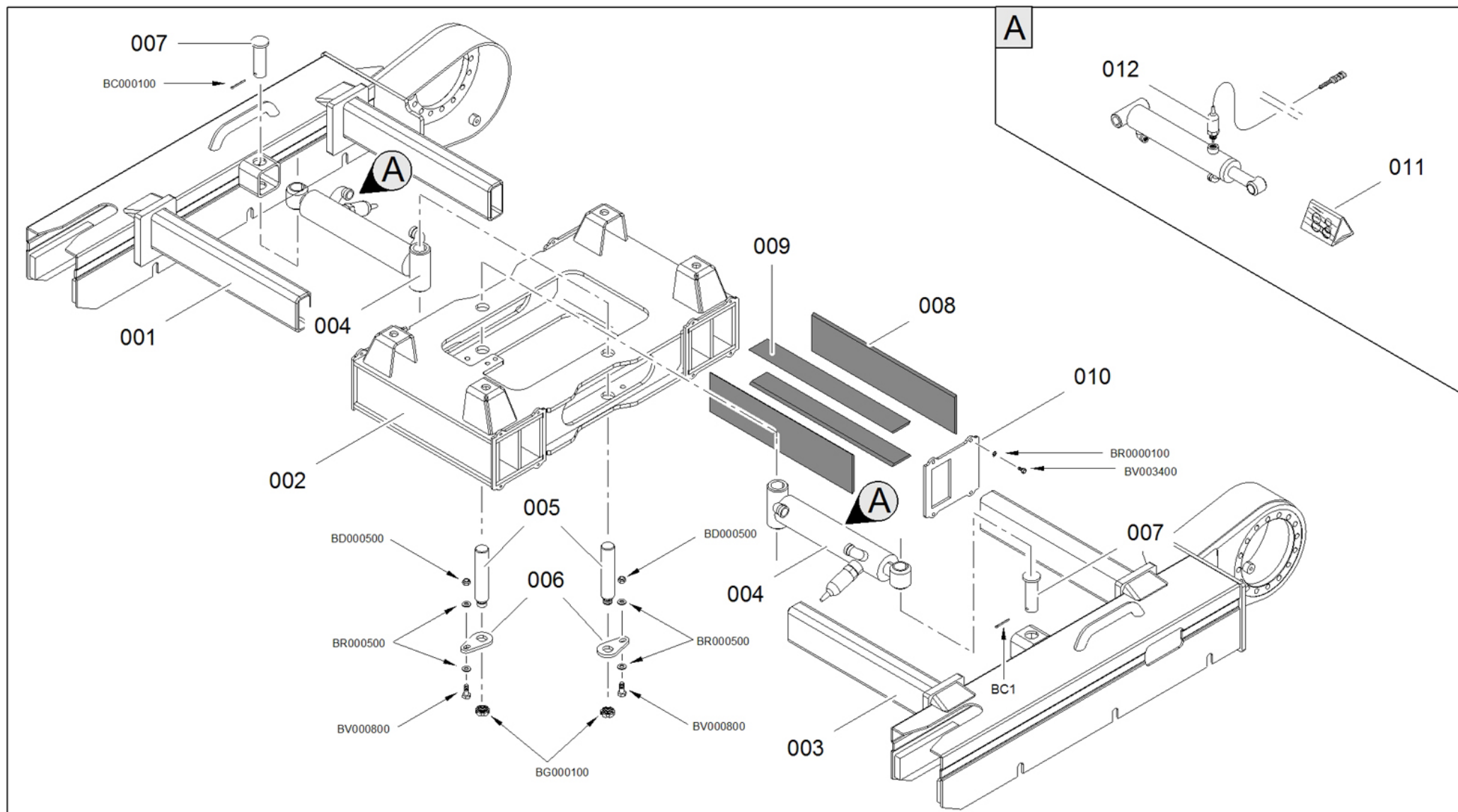
HYDR. SPURWEITENVER STELLEINRICHTUNG 
 EXTENSION HIDRAULICA 







Main color codes:  J1 - JLG Cream,  J2 - JLG Orange,  C4 - Green

 ALLARGAMENTO IDRAULICO

 HYDRAULIC EXTENSION

 ECARTEMENT HYDRAULIQUE
HYDR. SPURWEITENVER STELLEINRICHTUNG EXTENSION HIDRAULICA 



POS	Codice	 Descrizione	 Description	 Designation	 Benennung	 Descripción
1	377583A3	LONGHERONE DESTRO SOTTOCARRO ALLARGABILE LL1570 AUTO2SPEED	RIGHT EXTENDABLE UNDERCARRIAGE LL1570 AUTO2SPEED	PARTIE DROITE CHENILLARD	FAHRWERK RECHTE SEITE	PARTE DERECHA DEL CARRO
1	377583H2	LONGHERONE DESTRO SOTTOCARRO ALLARGABILE LL1570 AUTO2SPEED	RIGHT EXTENDABLE UNDERCARRIAGE LL1570 AUTO2SPEED	PARTIE DROITE CHENILLARD	FAHRWERK RECHTE SEITE	PARTE DERECHA DEL CARRO
1	378038A3	LONGHERONE DESTRO SOTTOCARRO ALLARGABILE LL1570 SINGOLA VELOCITA' HINOWA GREY	LONGHERONE RIGHT EXTENDABLE UNDERCARRIAGE LL1570 SINGLE SPEED 'HINOWA GREY	TRAIN DE CHENILLE DROITE	RECHTER FAHRSCHEFF	PARTE CARRO DERECHO
1	378038H2	LONGHERONE DESTRO SOTTOCARRO ALLARGABILE LL1570 SINGOLA VELOCITA' HINOWA GREY	LONGHERONE RIGHT EXTENDABLE UNDERCARRIAGE LL1570 SINGLE SPEED 'HINOWA GREY	TRAIN DE CHENILLE DROITE	RECHTER FAHRSCHEFF	PARTE CARRO DERECHO
2	377559A3	STRUTTURA CENTRALE SOTTOCARRO LL1570 SALDATA	CENTRAL STRUCTURE UNDERCARRIAGE LL1570 WELDED	ESTRUCTURE CENTRALE	MITTELBAU	ESTRUCTURA CENTRAL
2	377559H2	STRUTTURA CENTRALE SOTTOCARRO LL1570 SALDATA	CENTRAL STRUCTURE UNDERCARRIAGE LL1570 WELDED	ESTRUCTURE CENTRALE	MITTELBAU	ESTRUCTURA CENTRAL

 ALLARGAMENTO IDRAULICO

 HYDRAULIC EXTENSION

 ECARTEMENT HYDRAULIQUE
HYDR. SPURWEITENVER STELLEINRICHTUNG EXTENSION HIDRAULICA 





POS	Codice	 Descrizione	 Description	 Designation	 Benennung	 Descripción
3	377584A3	LONGHERONE SINISTRO SOTTOCARRO ALLARGABILE LL1570 AUTO2SPEED	LEFT EXTENDABLE UNDERCARRIAGE LL1570 AUTO2SPEED	PARTIE GAUCHE CHENILLARD	FAHRWERK LINKER SEITE	PARTE IZQUIERDA DEL CARRO
3	377584H2	LONGHERONE SINISTRO SOTTOCARRO ALLARGABILE LL1570 AUTO2SPEED	LEFT EXTENDABLE UNDERCARRIAGE LL1570 AUTO2SPEED	PARTIE GAUCHE CHENILLARD	FAHRWERK LINKER SEITE	PARTE IZQUIERDA DEL CARRO
3	378039A3	LONGHERONE DESTRO SOTTOCARRO ALLARGABILE LL1570 SINGOLA VELOCITA' HINOWA GREY	LONGHERONE RIGHT EXTENDABLE UNDERCARRIAGE LL1570 SINGLE SPEED 'HINOWA GREY	TRAIN DE CHENILLE DROIT	RECHTER FAHRSCHIFF	PARTE CARRO DERECHO
3	378039H2	LONGHERONE DESTRO SOTTOCARRO ALLARGABILE LL1570 SINGOLA VELOCITA' HINOWA GREY	LONGHERONE RIGHT EXTENDABLE UNDERCARRIAGE LL1570 SINGLE SPEED 'HINOWA GREY	TRAIN DE CHENILLE DROIT	RECHTER FAHRSCHIFF	PARTE CARRO DERECHO
4	277103A3	CILINDRO ALLARGAMENTO CARRO LL1570-X15JP- X430AJ	CYLINDER ENLARGEMENT CARRIAGE LL1570- X15JP-X430AJ	CYLINDRE ÉLARGISSEMENT	SPURVERBREITERUN GSZYLINDER	CILINDRO ENSANCHAMIENTO
4	277103H2	CILINDRO ALLARGAMENTO CARRO LL1570-X15JP- X430AJ	CYLINDER ENLARGEMENT CARRIAGE LL1570- X15JP-X430AJ	CYLINDRE ÉLARGISSEMENT	SPURVERBREITERUN GSZYLINDER	CILINDRO ENSANCHAMIENTO
5	06023800	SPINA FONDELLO ALLARGAMENTO	BOTTOM PLUG ENLARGEMENT	BAS PLUG ELARGISSEMENT	UNTEN PLUG ERWEITERUNG	BASE ENCHUFE AMPLIACIÓN
6	064965Y1	GOCCIA SPINA	PIN DROP	BAISSE CHEVILLE	TROPFEN	CAÍDA CLAVIJA
7	04256300	SPINA	PIN	CHEVILLE	STIFT	CLAVIJA



Main color codes:  J1 - JLG Cream,  J2 - JLG Orange,  C4 - Green



 ALLARGAMENTO IDRAULICO

 HYDRAULIC EXTENSION



 ECARTEMENT HYDRAULIQUE
HYDR. SPURWEITENVER STELLEINRICHTUNG EXTENSION HIDRAULICA 

POS	Codice	 Descrizione	 Description	 Designation	 Benennung	 Descripción
8	07758900	GUIDA ALLARGAMENTO LL1570-X15JP-X430AJ 88X4.2X374	ENLARGEMENT GUIDE LL1570-X15JP- X430AJ 88X4.2X374	GUIDE	FÜHRUNG	GUÍA
9	07758800	GUIDA ALLARGAMENTO LL1570 48X4.2X374	GUIDE	GUIDE	FÜHRUNG	GUÍA
10	377580A3	COPERCHIO FERMO GUIDE ALLARGAMENTO LL1570	COVER GUIDE ENLARGEMENT LL1570	COUVERCLE	ABDECKUNG	TAPA
10	377580H2	COPERCHIO FERMO GUIDE ALLARGAMENTO LL1570	COVER GUIDE ENLARGEMENT LL1570	COUVERCLE	ABDECKUNG	TAPA
11	2771030001	KIT GUARNIZIONE CILINDRO ALLARGAMENTO CARRO LL1570 X15JP X430AJ	CYLINDER SEAL KIT CARRIAGE ENLARGEMENT LL1570 X15JP X430AJ	KIT JOINT	DICHTUNGSSATZ	KIT JUNTAS
12	17329500	MICROINTERRUPTOR E ALLARGAMENTO CARRO N/O COMPLETO DI CAVO E CONNETTORE	WIDENING SYSTEM MICRO SWITCH N/O CONTACT WITH CABLE AND CONNECTOR	MICRO INTERRUPTEUR ELARGISSEMENT AVEC CABLE ET CONNECTEUR	MIKROSCHALTER SPURVERBREITERUN G MIT KABEL UND STECKER	MICROINTERRUPTOR ENSANCHAMIENTO CON CABLE Y CONECTOR

-  BASE TORRETTA
-  TURRET BASE
-  BASE TOURELLE

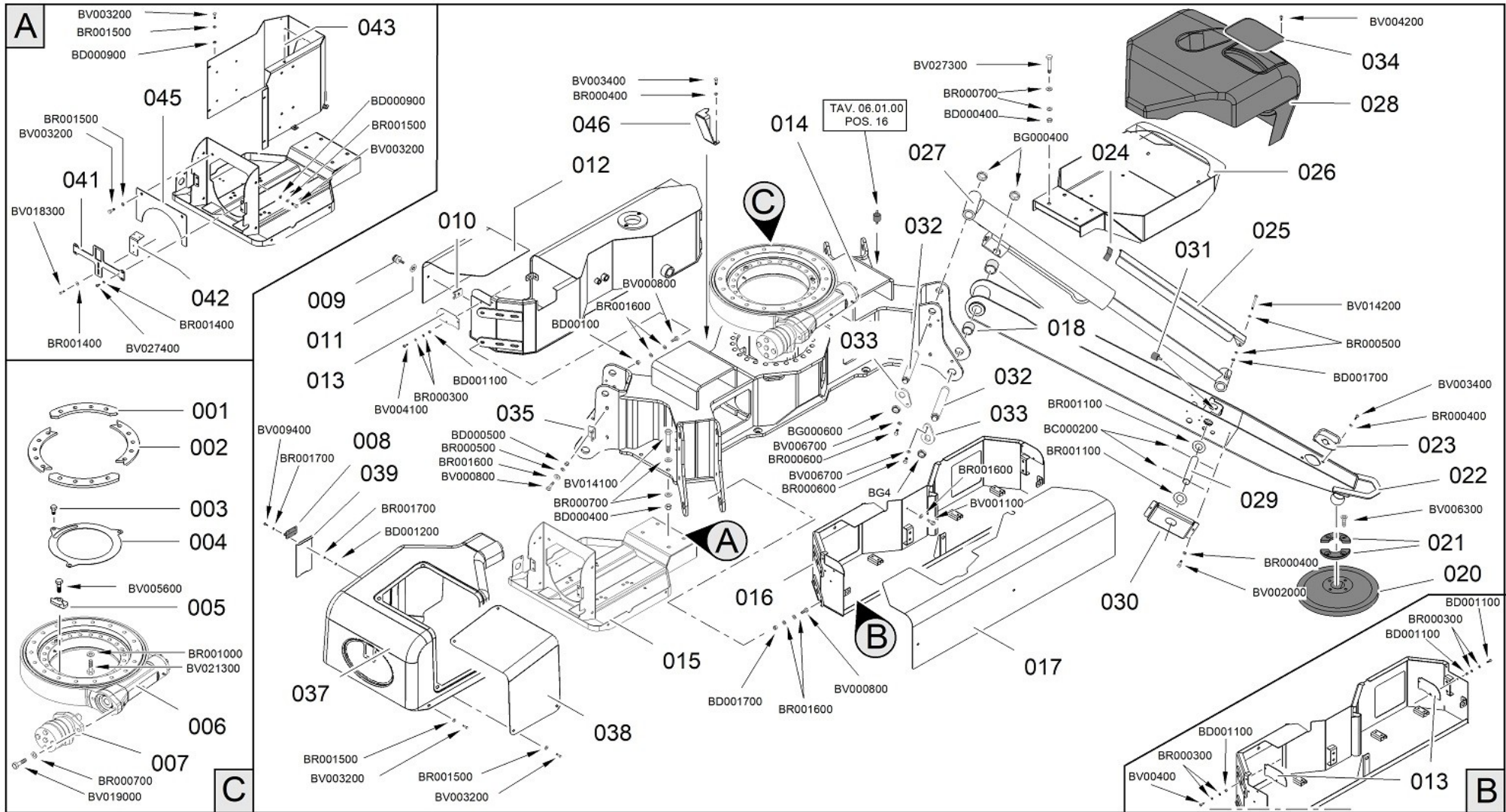
ARBEITSTURM 
 BASE TORRETA GIRATORIA 











Main color codes:  J1 - JLG Cream,  J2 - JLG Orange,  C4 - Green

 BASE TORRETTA

 TURRET BASE

 BASE TOURELLE
ARBEITSTURM BASE TORRETTA GIRATORIA 





POS	Codice	 Descrizione	 Description	 Designation	 Benennung	 Descripción
1	069349Y1	SPESSORE	THICKNESS	CALE	STÄRKE	ESPEJOR
2	069348Y1	SPESSORE	THICKNESS	CALE	STÄRKE	ESPEJOR
4	077710Y1	RISCONTRO	FASTENER LOCATOR	PLAQUE POUR AGRAFAGE	ANSCHLAG	GANCHO
5	068911Y1	FERMO	RETAINER	ARRÊT	HALTERUNG	BLOQUE
6	269450A3	RALLA	FIFTH WHEEL	COURONNE DENTÉE	DREHKRANZ	TEJUELO
6	269450H2	RALLA	FIFTH WHEEL	COURONNE DENTÉE	DREHKRANZ	TEJUELO
7	261308A3	MOTORE DI ROTAZIONE	ROTARY MOTOR	MOTEUR DE ROTATION	ROTATIONSMOTOR	MOTOR DE ROTACIÓN
7	261308H2	MOTORE DI ROTAZIONE	ROTARY MOTOR	MOTEUR DE ROTATION	ROTATIONSMOTOR	MOTOR DE ROTACIÓN
8	07178700	CERNIERA CON CONTROLLO DELLA POSIZIONE	HINGES WITH POSITION CONTROL	CHARNIÈRE	SCHARNIER	BISAGRA
9	07343200	VITE IMPERDIBILE ZIGRINATA CORTA	SHORT IMPERDIBLE KNURLED SCREW	VIS IMPERDABLE	SCHRAUBE	TORNILLO IMPERDIBLE
10	07343300	RICETTACOLO PER VITE IMPERDIBILE	RECEPTACLE FOR IMPERDIBLE SCREW	PRISE DE VIS POUR VIS IMPERDABLE	AUFNAHME FÜR SCHRAUBE	REFUGIO TORNILLO IMPERDIBLE
11	07343400	AGGANCIO PER VITE IMPERDIBILE	COUPLING FOR IMPERDIBLE SCREW	CROCHET VIS IMPERDABLE	HAKEN FÜR SCHRAUBE	GANCHO TORNILLO IMPERDIBLE
12	077481A3	COPERCHIO VANO BATTERIA	COVER BATTERY COMPARTMENT	COUVERCLE	DECKEL	TAPA
12	077481A6	COPERCHIO VANO BATTERIA	COVER BATTERY COMPARTMENT	COUVERCLE	DECKEL	TAPA
12	077481A8	COPERCHIO VANO BATTERIA	COVER BATTERY COMPARTMENT	COUVERCLE	DECKEL	TAPA
12	077481B1	COPERCHIO VANO BATTERIA	COVER BATTERY COMPARTMENT	COUVERCLE	DECKEL	TAPA
12	077481C4	COPERCHIO VANO BATTERIA	COVER BATTERY COMPARTMENT	COUVERCLE	DECKEL	TAPA
12	077481CD	COPERCHIO VANO BATTERIA	COVER BATTERY COMPARTMENT	COUVERCLE	DECKEL	TAPA
12	077481DQ	COPERCHIO VANO BATTERIA	COVER BATTERY COMPARTMENT	COUVERCLE	DECKEL	TAPA



Main color codes:  J1 - JLG Cream,  J2 - JLG Orange,  C4 - Green

 BASE TORRETTA





 TURRET BASE



 BASE TOURELLE
ARBEITSTURM BASE TORRETTA GIRATORIA 

POS	Codice	 Descrizione	 Description	 Designation	 Benennung	 Descripción
12	077481EW	COPERCHIO VANO BATTERIA	COVER BATTERY COMPARTMENT	COUVERCLE	DECKEL	TAPA
12	077481H1	COPERCHIO VANO BATTERIA	COVER BATTERY COMPARTMENT	COUVERCLE	DECKEL	TAPA
12	077481J2	COPERCHIO VANO BATTERIA	COVER BATTERY COMPARTMENT	COUVERCLE	DECKEL	TAPA
13	077446A3	TAPPO	CAP	COUVERCLE	ABDECKUNG	TAPA
13	077446A6	TAPPO LATERALE	CAP	BOUCHON	VERSCHLUSS	TAPA
13	077446A8	TAPPO	CAP	COUVERCLE	ABDECKUNG	TAPA
13	077446B1	TAPPO	CAP	COUVERCLE	ABDECKUNG	TAPA
13	077446C4	TAPPO LATERALE	CAP	COUVERCLE	DECKEL	TAPA
13	077446CD	TAPPO LATERALE	CAP	BOUCHON	VERSCHLUSS	TAPA
13	077446DQ	TAPPO	CAP	COUVERCLE	ABDECKUNG	TAPA
13	077446EW	TAPPO	CAP	COUVERCLE	ABDECKUNG	TAPA
13	077446H1	TAPPO	CAP	COUVERCLE	ABDECKUNG	TAPA
13	077446J2	TAPPO LATERALE	CAP	BOUCHON	VERSCHLUSS	TAPA
14	377414A3	BASE LL1570 SALDATA	BASE LL1570 WELDED	BASE LL1570 SAUDÉE	LL1570 GESCHWEISSTE BASIS	BASE SOLDATA LL1570
14	377414H2	BASE LL1570 SALDATA	BASE LL1570 WELDED	BASE LL1570 SAUDÉE	LL1570 GESCHWEISSTE BASIS	BASE SOLDATA LL1570
15	377732A3	ASSIEME SUPPORTO COMPONENTI ELETTRICI LL1570 SALDATO	ASSEMBLY SUPPORT ELECTRICAL COMPONENTS LL1570 WELDED	ENSEMBLE SUPPORT COMPOSANT ÉLECTRIQUES LL1570	HALTERUNG FÜR ELEKTRISCHE KOMPONENTEN	SOPORTE COMPONENTES ELÉCTRICOS
15	377732H2	ASSIEME SUPPORTO COMPONENTI ELETTRICI LL1570 SALDATO	ASSEMBLY SUPPORT ELECTRICAL COMPONENTS LL1570 WELDED	ENSEMBLE SUPPORT COMPOSANT ÉLECTRIQUES LL1570	HALTERUNG FÜR ELEKTRISCHE KOMPONENTEN	SOPORTE COMPONENTES ELÉCTRICOS
16	377439A3	SCATOLA IMPIANTO IDRAULICO LL1570 SALDATA	BOX HYDRAULIC LL1570 WELDED	BOÎTIER INSTALLATION HYDRAULIQUE	GEHÄUSE FÜR HYDRAULISCHE ANLAGE	CAJA INSTALACIÓN HIDRÁULICA
16	377439A6	SCATOLA IMPIANTO IDRAULICO LL1570 SALDATA	BOX HYDRAULIC LL1570 WELDED	BOÎTIER INSTALLATION HYDRAULIQUE	GEHÄUSE FÜR HYDRAULISCHE ANLAGE	CAJA INSTALACIÓN HIDRÁULICA

Main color codes:  J1 - JLG Cream,  J2 - JLG Orange,  C4 - Green

 BASE TORRETTA TURRET BASE BASE TOURELLEARBEITSTURM BASE TORRETTA GIRATORIA 

POS	Codice	 Descrizione	 Description	 Designation	 Benennung	 Descripción
16	377439A8	SCATOLA IMPIANTO IDRAULICO LL1570 SALDATA	BOX HYDRAULIC LL1570 WELDED	BOÎTIER INSTALLATION HYDRAULIQUE	GEHÄUSE FÜR HYDRAULISCHE ANLAGE	CAJA INSTALACIÓN HIDRÁULICA
16	377439B1	SCATOLA IMPIANTO IDRAULICO LL1570 SALDATA	BOX HYDRAULIC LL1570 WELDED	BOÎTIER INSTALLATION HYDRAULIQUE	GEHÄUSE FÜR HYDRAULISCHE ANLAGE	CAJA INSTALACIÓN HIDRÁULICA
16	377439C4	SCATOLA IMPIANTO IDRAULICO LL1570 SALDATA	BOX HYDRAULIC LL1570 WELDED	BOÎTE	GEHÄUSE	CAJA
16	377439CD	SCATOLA IMPIANTO IDRAULICO LL1570 SALDATA	BOX HYDRAULIC LL1570 WELDED	BOÎTIER INSTALLATION HYDRAULIQUE	GEHÄUSE FÜR HYDRAULISCHE ANLAGE	CAJA INSTALACIÓN HIDRÁULICA
16	377439DQ	SCATOLA IMPIANTO IDRAULICO	BOX HYDRAULIC	BOITE	GEHÄUSE	CAJA
16	377439EW	SCATOLA IMPIANTO IDRAULICO	BOX HYDRAULIC	BOITE	GEHÄUSE	CAJA
16	377439H1	SCATOLA IMPIANTO IDRAULICO	BOX HYDRAULIC	BOITE	GEHÄUSE	CAJA
16	377439J2	SCATOLA IMPIANTO IDRAULICO LL1570 SALDATA	BOX HYDRAULIC LL1570 WELDED	BOÎTIER INSTALLATION HYDRAULIQUE	GEHÄUSE FÜR HYDRAULISCHE ANLAGE	CAJA INSTALACIÓN HIDRÁULICA
17	077447A3	COPERCHIO VANO COMPONENTI IDRAULICI	COVER HYDRAULIC COMPONENTS	COUVERCLE	ABDECKUNG	TAPA
17	077447A6	COPERCHIO VANO COMPONENTI IDRAULICI	COVER COMPARTMENT HYDRAULIC COMPONENTS	COUVERCLE	DECKEL	TAPA
17	077447A8	COPERCHIO VANO COMPONENTI IDRAULICI	COVER HYDRAULIC COMPONENTS	COUVERCLE	ABDECKUNG	TAPA
17	077447B1	COPERCHIO VANO COMPONENTI IDRAULICI	COVER HYDRAULIC COMPONENTS	COUVERCLE	ABDECKUNG	TAPA



Main color codes:  J1 - JLG Cream,  J2 - JLG Orange,  C4 - Green

 BASE TORRETTA



 TURRET BASE



 BASE TOURELLE
ARBEITSTURM BASE TORRETTA GIRATORIA 

POS	Codice	 Descrizione	 Description	 Designation	 Benennung	 Descripción
17	077447C4	COPERCHIO VANO COMPONENTI IDRAULICI	COVER COMPARTMENT HYDRAULIC COMPONENTS	COUVERCLE	DECKEL	TAPA
17	077447CD	COPERCHIO VANO COMPONENTI IDRAULICI	COVER COMPARTMENT HYDRAULIC COMPONENTS	COUVERCLE	DECKEL	TAPA
17	077447DQ	COPERCHIO COMPONENTI ELETTRICI	COVER ELECTRICAL COMPONENTS	COUVERCLE	ABDECKUNG	TAPA
17	077447EW	COPERCHIO VANO COMPONENTI IDRAULICI	COVER HYDRAULIC COMPONENTS	COUVERCLE	ABDECKUNG	TAPA
17	077447H1	COPERCHIO VANO COMPONENTI IDRAULICI	COVER HYDRAULIC COMPONENTS	COUVERCLE	ABDECKUNG	TAPA
17	077447J2	COPERCHIO VANO COMPONENTI IDRAULICI	COVER COMPARTMENT HYDRAULIC COMPONENTS	COUVERCLE	DECKEL	TAPA
18	07765300	BOCCOLA DEVA.TEX552 253030	BUSH DEVA. TEX 552 253030	DOUILLE	BUCHSE	CASQUILLO
20	05446300	DISCO	DISK	DISQUE	SCHEIBE	DISCO
21	073147Y1	SEMIFLANGIA	HALF FLANGE	DEMI-BRIDE	HALB FLANSCH	SEMI BRIDA
22	177406A3	ASSIEME STABILIZZATORE COMPLETO	ASSEMBLY COMPLETE STABILIZE	STABILISATEUR	ABSTÜTZUNG	ESTABILIZADOR
22	177406A6	ASSIEME STABILIZZATORE COMPLETO	ASSEMBLY COMPLETE STABILIZE	STABILISATEUR	ABSTÜTZUNG	ESTABILIZADOR
22	177406A8	ASSIEME STABILIZZATORE COMPLETO	ASSEMBLY COMPLETE STABILIZE	STABILISATEUR	ABSTÜTZUNG	ESTABILIZADOR

Main color codes:  J1 - JLG Cream,  J2 - JLG Orange,  C4 - Green

 BASE TORRETTA TURRET BASE BASE TOURELLEARBEITSTURM BASE TORRETTA GIRATORIA 





POS	Codice	 Descrizione	 Description	 Designation	 Benennung	 Descripción
22	177406B1	ASSIEME STABILIZZATORE COMPLETO	ASSEMBLY COMPLETE STABILIZE	STABILISATEUR	ABSTÜTZUNG	ESTABILIZADOR
22	177406C4	ASSIEME STABILIZZATORE COMPLETO	ASSEMBLY COMPLETE STABILIZE	STABILISATEUR	ABSTÜTZUNG	ESTABILIZADOR
22	177406CD	ASSIEME STABILIZZATORE COMPLETO	ASSEMBLY COMPLETE STABILIZE	STABILISATEUR	ABSTÜTZUNG	ESTABILIZADOR
22	177406DQ	ASSIEME STABILIZZATORE COMPLETO	ASSEMBLY COMPLETE STABILIZE	STABILISATEUR	ABSTÜTZUNG	ESTABILIZADOR
22	177406EW	ASSIEME STABILIZZATORE COMPLETO	ASSEMBLY COMPLETE STABILIZE	STABILISATEUR	ABSTÜTZUNG	ESTABILIZADOR
22	177406H1	ASSIEME STABILIZZATORE COMPLETO	ASSEMBLY COMPLETE STABILIZE	STABILISATEUR	ABSTÜTZUNG	ESTABILIZADOR
22	177406H2	ASSIEME STABILIZZATORE COMPLETO	ASSEMBLY COMPLETE STABILIZER	STABILISATEUR COMPLET	ABSTÜTZUNG KOMPLETT	ESTABILIZADOR COMPLETO
22	177406J2	ASSIEME STABILIZZATORE COMPLETO	ASSEMBLY COMPLETE STABILIZE	STABILISATEUR	ABSTÜTZUNG	ESTABILIZADOR
23	376018A3	SUPPORTO SPIA STABILIZZATORE (FOR LL2010-X20JP- X600AJ MK2 FROM C170000893)	OUTRIGGER LIGHT SUPPORT (FOR LL2010-X20JP-X600AJ MK2 FROM C170000893)	SUPPORT LUMIÈRE STABILISATEUR (FOR LL2010-X20JP-X600AJ MK2 FROM C170000893)	LICHTHALTERUNG (FOR LL2010-X20JP- X600AJ MK2 FROM C170000893)	SOPORTE LUZ (FOR LL2010-X20JP-X600AJ MK2 FROM C170000893)
23	376018H2	SUPPORTO SPIA STABILIZZATORE (FOR LL2010-X20JP- X600AJ MK2 FROM C170000893)	OUTRIGGER LIGHT SUPPORT (FOR LL2010-X20JP-X600AJ MK2 FROM C170000893)	SUPPORT LUMIÈRE STABILISATEUR (FOR LL2010-X20JP-X600AJ MK2 FROM C170000893)	LICHTHALTERUNG (FOR LL2010-X20JP- X600AJ MK2 FROM C170000893)	SOPORTE LUZ (FOR LL2010-X20JP-X600AJ MK2 FROM C170000893)

Main color codes:  J1 - JLG Cream,  J2 - JLG Orange,  C4 - Green

 BASE TORRETTA

 TURRET BASE





 BASE TOURELLE
ARBEITSTURM BASE TORRETTA GIRATORIA 



POS	Codice	 Descrizione	 Description	 Designation	 Benennung	 Descripción
24	07894900	GOMMA ADESIVA DI PROTEZIONE L=70	RUBBER ADHESIVE PROTECTION L=70	GOMME ADHESIVE DE PROTECTION L=70	SCHUTZ-KLEBEGUMMI L=70	GOMA ADHESIVA DE PROTECCIÓN L=70
25	072700A3	CARTER DI PROTEZIONE	PROTECTION COVER	CARTER DE DE PROTECTION	CARTER VON SCHUTZ	CARTER DE PROTECCIÓN
25	072700H2	CARTER DI PROTEZIONE	PROTECTION COVER	CARTER DE PROTECTION	CARTER VON SCHUTZ	CARTER DE PROTECCIÓN
26	377484A3	SUPPORTO MOTORE TERMICO LL1570 SALDATO	SUPPORT ENGINE LL1570 WELDED	SUPPORT MOTEUR	HALTERUNG FÜR MOTOR	SOPORTE MOTOR
26	377484H2	SUPPORTO MOTORE TERMICO LL1570 SALDATO	SUPPORT ENGINE LL1570 WELDED	SUPPORT MOTEUR	HALTERUNG FÜR MOTOR	SOPORTE MOTOR
27	282209A3	CILINDRO STABILIZZATORE	OUTRIGGER CYLINDER	VÉRIN STABILISATEUR	STÜTZFUßZYLINDER	CILINDRO ESTABILIZADOR
27	282209H2	CILINDRO STABILIZZATORE	OUTRIGGER CYLINDER	VÉRIN STABILISATEUR HINOWA GREY	STÜTZFUßZYLINDER HINOWA GREY	CILINDRO ESTABILIZADOR HINOWA GREY
28	377953A3	COFANO MOTORE DIESEL	ENGINE COVER DIESEL	CAPOT	MOTORHAUBE	CAPÓ
28	377953H2	COFANO MOTORE DIESEL	ENGINE COVER DIESEL	CAPOT	MOTORHAUBE	CAPÓ
28	377954A3	COFANO MOTORE BENZINA	ENGINE COVER PETROL	CAPOT MOTEUR ESSENCE	MOTORHAUBE FÜR BENZIN MOTOR	CAPÓ PARA MOTOR DE GASOLINA
28	377954H2	COFANO MOTORE BENZINA	ENGINE COVER PETROL	CAPOT MOTEUR ESSENCE	MOTORHAUBE FÜR BENZIN MOTOR	CAPÓ PARA MOTOR DE GASOLINA
29	07754600	SPINA OCCHIO CILINDRO STABILIZZATORE LL1570-X15JP-X430AJ	PIN EYE CYLINDER STABILIZER LL1570-X15JP-X430AJ	AXE	STIFT	CLAVIJA
30	077413A3	PIEGATO PROTEZIONE MICRO STABILIZZATORE	BENT PROTECTION MICRO STABILIZER	PROTECTION MICROINTERRUPTEUR	SCHUTZABDECKUNG MIKROSCHALTER	PROTECCIÓN MICROINTERRUPTOR

 BASE TORRETTA





 TURRET BASE



 BASE TOURELLE
ARBEITSTURM BASE TORRETTA GIRATORIA 



POS	Codice	 Descrizione	 Description	 Designation	 Benennung	 Descripción
30	077413H2	PIEGATO PROTEZIONE MICRO STABILIZZATORE	BENT PROTECTION MICRO STABILIZER	PROTECTION MICROINTERRUPTEUR	SCHUTZABDECKUNG MIKROSCHALTER	PROTECCIÓN MICROINTERRUPTOR
31	28185800	ANTIVIBRANTE	ANTI-VIBRATING	ANTI - VIBRANT	VIBRATIONSDÄMPFER	ANTIVIBRANTE
32	07772000	PERNO ATTACCO STABILIZZATORE A BASE LL1570-X15JP- X430AJ	PIN CONNECTION STABILIZER BASED LL1570-X15JP-X430AJ	AXE	STIFT	PERNIO
33	064966Y1	GOCCIA SPINA	PIN DROP	BAISSE CHEVILLE	TROPFEN STIFT	CAÍDA CLAVIJA
34	077955A3	COPERCHIO PER ACCESSO A FILTRO ARIA SU MOTORE BENZINA	COVER FOR ACCESS TO AIR FILTER ON GASOLINE ENGINE	COUVERCLE	DECKEL	TAPA
34	077955H2	COPERCHIO PER ACCESSO A FILTRO ARIA SU MOTORE BENZINA	COVER FOR ACCESS TO AIR FILTER ON GASOLINE ENGINE	COUVERCLE	DECKEL	TAPA
34	077955NV	COPERCHIO PER ACCESSO A FILTRO ARIA SU MOTORE	COVER FOR ACCESS TO AIR FILTER ON GASOLINE ENGINE	COUVERCLE	DECKEL	TAPA
35	055629H3	STAFFA	BRACKET	ÉTRIER	HALTEBÜGEL	ESTRIBO
37	077742A3	COFANO MOTORE ELETTRICO	ELECTRIC ENGINE COVER	CAPOT	MOTOR HAUBE	CAPÓ
37	077742H2	COFANO MOTORE ELETTRICO	ELECTRIC ENGINE COVER	CAPOT	MOTOR HAUBE	CAPÓ
38	077743A3	PORTELLO LATERALE MANUTENZIONE MOTORE ELETTRICO	DOOR LATERAL MAINTENANCE ELECTRIC MOTOR	GUICHET	ABDECKPLATTE	PORTILLA
38	077743H2	PORTELLO LATERALE MANUTENZIONE MOTORE ELETTRICO	DOOR LATERAL MAINTENANCE ELECTRIC MOTOR	GUICHET	ABDECKPLATTE	PORTILLA
39	077744A3	PORTELLO ACCESSO CHIAVE EMERGENZE	DOOR ACCESS KEY EMERGENCIAS	GUICHET	ABDECKPLATTE	PORTILLA

Main color codes:  J1 - JLG Cream,  J2 - JLG Orange,  C4 - Green



 BASE TORRETTA TURRET BASE BASE TOURELLEARBEITSTURM BASE TORRETA GIRATORIA 



POS	Codice	 Descrizione	 Description	 Designation	 Benennung	 Descripción
39	077744H2	PORTELLO ACCESSO CHIAVE EMERGENZE	DOOR ACCESS KEY EMERGENCIES	GUICHET	ABDECKPLATTE	PORTILLA
41	077745Y1	PIATTO FISSAGGIO FOTOCELLULA CATAFORESI	PLATE FIXING PHOTOCELL	PLAQUE	PLATTE	PLACA
42	061185Y1	LAMIERA PIEGATA	FOLDED PLATE	TÔLE PLIÉE	BLECH GEBOGEN	CHAPA DOBLADA
43	077738Y1	PIEGATO FISSAGGIO COMPONENTI ELETTRICI LL1570	BENT FIXING ELECTRICAL COMPONENTS LL1570	SUPPORT	HALTERUNG	SOPORTE
45	077740Y1	PARATIA SUPERIORE MOTORE ELETTRICO LL1570	UPPER PLATE ELECTRIC MOTOR LL1570	PLAQUE	PLATTE	PLACA
46	077721D2	INDICE ALLINEAMENTO FISSO LL1570	ALIGNMENT INDEX FIXED LL1570	INDEX	INDEX	ÍNDICE

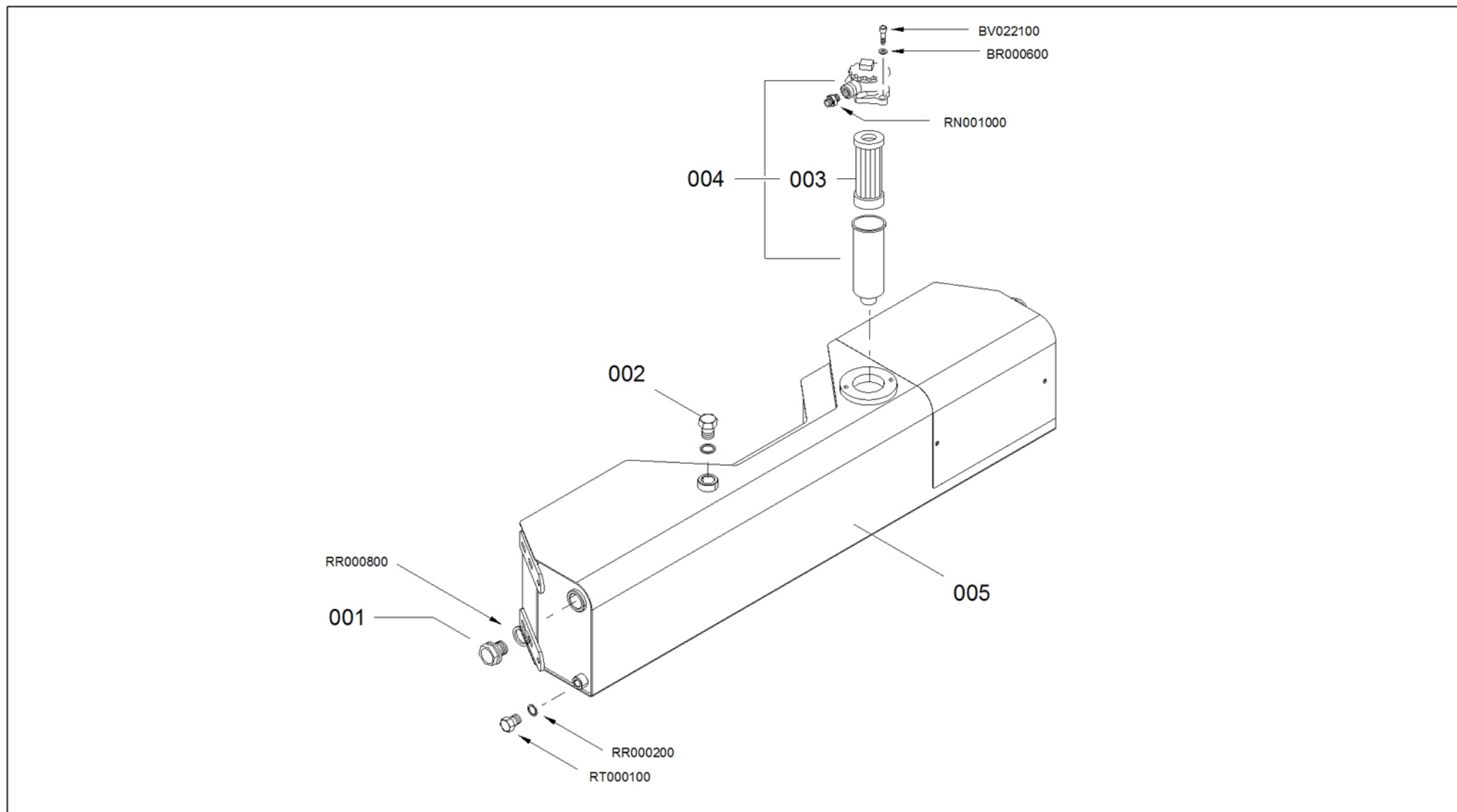

-  SERBATOIO OLIO
-  OIL TANK
-  RÉSERVOIR D'HUILE





ÖLTANK 
DEPÓSITO DE ACEITE 



Main color codes:  J1 - JLG Cream,  J2 - JLG Orange,  C4 - Green

 SERBATOIO OLIO
 OIL TANK
 RÉSERVOIR D'HUILE

ÖLTANK 
 DEPÓSITO DE ACEITE 



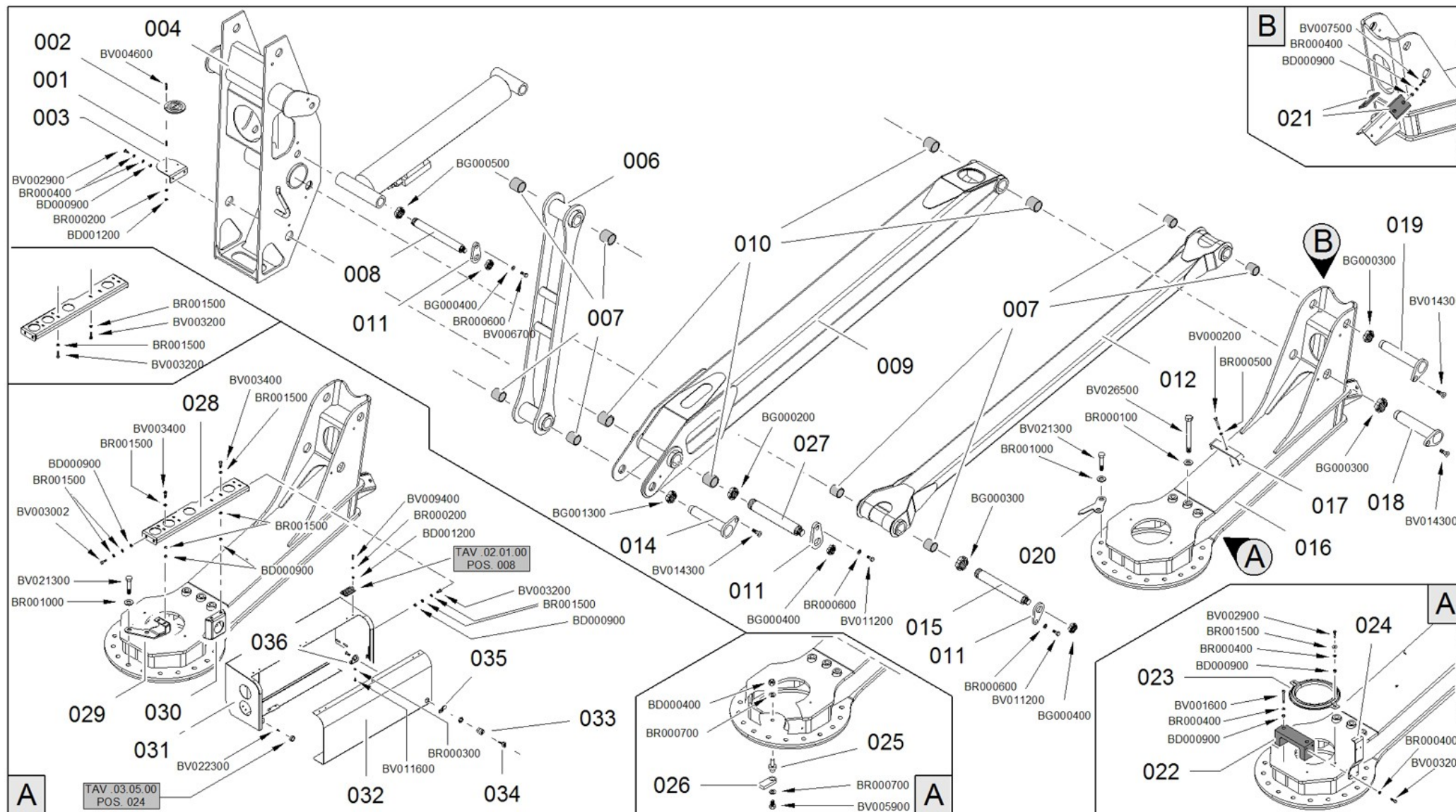

POS	Codice	 Descrizione	 Description	 Designation	 Benennung	 Descripción
1	05061800	LIVELLO OLIO	OIL LEVEL	NIVEAU HUILE	ÖLSTAND	NIVEL ACEITE
2	05611800	TAPPO OLIO	OIL PLUG	BOUCHON D'HUILE	ÖLDECKEL	TAPÓN ACEITE
3	05120200	CARTUCCIA FILTRO OLIO IDRAULICO	HYDRAULIC FILTER	CARTOUCHE FILTRE À HUILE	ÖLFILTEREINSATZ	CARTUCHO FILTRO ACEITE
4	15120100	FILTRO OLIO IDRAULICO COMPLETO	COMPLETE HYDRAULIC OIL FILTER	FILTRE À HUILE	HYDARULIKÖLFILTER	FILTRO ACEITE HIDRÁULICO
5	177477A3	SERBATOIO OLIO COMPLETO LL1570	OIL TANK LL1570	RÉSERVOIR HUILE	ÖLTANK	DEPÓSITO DE ACEITE
5	177477A6	SERBATOIO OLIO COMPLETO LL1570	OIL TANK LL1570	RÉSERVOIR HUILE	ÖLTANK	DEPÓSITO DE ACEITE
5	177477A8	SERBATOIO OLIO COMPLETO LL1570	OIL TANK LL1570	RÉSERVOIR HUILE	ÖLTANK	DEPÓSITO DE ACEITE
5	177477B1	SERBATOIO OLIO COMPLETO LL1570	OIL TANK LL1570	RÉSERVOIR HUILE	ÖLTANK	DEPÓSITO DE ACEITE
5	177477C4	SERBATOIO OLIO COMPLETO LL1570	OIL TANK LL1570	RESERVOIR HUILE	ÖLTANK	DEPÓSITO DE ACEITE
5	177477CD	SERBATOIO OLIO COMPLETO LL1570	OIL TANK LL1570	RÉSERVOIR HUILE	ÖLTANK	DEPÓSITO DE ACEITE
5	177477DQ	SERBATOIO OLIO COMPLETO	OIL TANK COMPLETE	RESERVOIR HUILE COMPLET	ÖLTANK KOMPLETT	DEPOSITO ACEITE COMPLETO
5	177477EW	SERBATOIO OLIO COMPLETO	OIL TANK COMPLETE	RESERVOIR HUILE COMPLET	ÖLTANK KOMPLETT	DEPOSITO ACEITE COMPLETO
5	177477H1	SERBATOIO OLIO COMPLETO	OIL TANK COMPLETE	RESERVOIR HUILE COMPLET	ÖLTANK KOMPLETT	DEPOSITO ACEITE COMPLETO
5	177477J2	SERBATOIO OLIO COMPLETO LL1570	OIL TANK LL1570	RÉSERVOIR HUILE	ÖLTANK	DEPÓSITO DE ACEITE





 PRIMO BRACCIO

 FIRST ARM

 PREMIER BRAS
ERSTER AUSLEGERARM PRIMO BRAZO 





POS	Codice	 Descrizione	 Description	 Designation	 Benennung	 Descripción
1	05444800	MOLLA	SPRING	RESSORT	FEDER	MUELLE
2	05427200	LIVELLA	LEVEL	NIVEAU	WASSERWAAGE	NIVEL DE BURBUJA
3	058832H3	SUPPORTO	SUPPORT	SUPPORT	HALTERUNG	SOPORTE
4	377599A6	RINVIO PRIMO- SECONDO BRACCIO LL1570 SALDATO	REFERENCE FIRST- SECOND BOOM LL1570 WELDED	RENVOI	VORGELEGE	REENVIO
4	377599A7	RINVIO PRIMO- SECONDO BRACCIO LL1570 SALDATO	REFERENCE FIRST- SECOND BOOM LL1570 WELDED	RENVOI	VORGELEGE	REENVIO
4	377599A8	RINVIO PRIMO- SECONDO BRACCIO LL1570 SALDATO	REFERENCE FIRST- SECOND BOOM LL1570 WELDED	RENVOI	VORGELEGE	REENVIO
4	377599B1	RINVIO PRIMO- SECONDO BRACCIO LL1570 SALDATO	REFERENCE FIRST- SECOND BOOM LL1570 WELDED	RENVOI	VORGELEGE	REENVIO
4	377599B6	RINVIO PRIMO- SECONDO BRACCIO LL1570 SALDATO	REFERENCE FIRST- SECOND BOOM LL1570 WELDED	RENVOI	VORGELEGE	REENVIO
4	377599BP	RINVIO PRIMO- SECONDO BRACCIO LL1570 SALDATO	REFERENCE FIRST- SECOND BOOM LL1570 WELDED	RENVOI	VORGELEGE	REENVIO
4	377599BR	RINVIO PRIMO- SECONDO BRACCIO LL1570 SALDATO	REFERENCE FIRST- SECOND BOOM LL1570 WELDED	RENVOI	VORGELEGE	REENVIO
4	377599C4	RINVIO PRIMO- SECONDO BRACCIO LL1570 SALDATO	REFERENCE FIRST- SECOND BOOM LL1570 WELDED	RENVOI	VORGELEGE	REENVIO
4	377599FX	RINVIO PRIMO- SECONDO BRACCIO LL1570 SALDATO	REFERENCE FIRST- SECOND BOOM LL1570 WELDED	RENVOI	VORGELEGE	REENVIO
4	377599GB	RINVIO PRIMO- SECONDO BRACCIO LL1570 SALDATO	REFERENCE FIRST- SECOND BOOM LL1570 WELDED	RENVOI	VORGELEGE	REENVIO



Main color codes:  J1 - JLG Cream,  J2 - JLG Orange,  C4 - Green

 PRIMO BRACCIO

 FIRST ARM

 PREMIER BRAS
ERSTER AUSLEGERARM PRIMO BRAZO 



POS	Codice	 Descrizione	 Description	 Designation	 Benennung	 Descripción
4	377599H1	RINVIO PRIMO- SECONDO BRACCIO	REFERENCE FIRST- SECOND BOOM	RENOI PREMIER- DEUXIEME BRAS	VORGELEGE ERSTER- ZWEITER ARM	REENVIO PRIMERO- SEGUNDO BRAZO
4	377599J1	RINVIO PRIMO- SECONDO BRACCIO LL1570 SALDATO	REFERENCE FIRST- SECOND BOOM LL1570 WELDED	RENOI	VORGELEGE	REENVIO
4	377599J2	RINVIO PRIMO- SECONDO BRACCIO	REFERENCE FIRST- SECOND BOOM	RENOI PREMIER- DEUXIEME BRAS	VORGELEGE ERSTER- ZWEITER ARM	REENVIO PRIMERO- SEGUNDO BRAZO
6	177114A6	BIELLA PRIMO- SECONDO BRACCIO LL1570 COMPLETA	CONNECTING ROD COMPLETE FIRST- SECOND BOOM LL1570	BIELLE	PLEUELSTANGE	BIELA
6	177114A7	BIELLA PRIMO- SECONDO BRACCIO LL1570 COMPLETA	CONNECTING ROD COMPLETE FIRST- SECOND BOOM LL1570	BIELLE	PLEUELSTANGE	BIELA
6	177114A8	BIELLA PRIMO- SECONDO BRACCIO LL1570 COMPLETA	CONNECTING ROD COMPLETE FIRST- SECOND BOOM LL1570	BIELLE	PLEUELSTANGE	BIELA
6	177114B1	BIELLA PRIMO- SECONDO BRACCIO LL1570 COMPLETA	CONNECTING ROD COMPLETE FIRST- SECOND BOOM LL1570	BIELLE	PLEUELSTANGE	BIELA
6	177114B6	BIELLA PRIMO- SECONDO BRACCIO LL1570 COMPLETA	CONNECTING ROD COMPLETE FIRST- SECOND BOOM LL1570	BIELLE	PLEUELSTANGE	BIELA
6	177114BP	BIELLA PRIMO- SECONDO BRACCIO LL1570 COMPLETA	CONNECTING ROD COMPLETE FIRST- SECOND BOOM LL1570	BIELLE	PLEUELSTANGE	BIELA



Main color codes:  J1 - JLG Cream,  J2 - JLG Orange,  C4 - Green

 PRIMO BRACCIO

 FIRST ARM

 PREMIER BRAS
ERSTER AUSLEGERARM PRIMO BRAZO 

POS	Codice	 Descrizione	 Description	 Designation	 Benennung	 Descripción
6	177114BR	BIELLA PRIMO- SECONDO BRACCIO LL1570 COMPLETA	CONNECTING ROD COMPLETE FIRST- SECOND BOOM LL1570	BIELLE	PLEUELSTANGE	BIELA
6	177114C4	BIELLA PRIMO- SECONDO BRACCIO LL1570 COMPLETA	CONNECTING ROD COMPLETE FIRST- SECOND BOOM LL1570	BIELLE	PLEUEL	BIELA
6	177114FX	BIELLA PRIMO- SECONDO BRACCIO LL1570 COMPLETA	CONNECTING ROD COMPLETE FIRST- SECOND BOOM LL1570	BIELLE	PLEUELSTANGE	BIELA
6	177114GB	BIELLA PRIMO- SECONDO BRACCIO LL1570 COMPLETA	CONNECTING ROD COMPLETE FIRST- SECOND BOOM LL1570	BIELLE	PLEUELSTANGE	BIELA
6	177114H1	BIELLA PRIMO- SECONDO BRACCIO	ROD FIRST-SECOND BOOM	BIELLE	PLEUELSTANGE	BIELA
6	177114J1	BIELLA PRIMO- SECONDO BRACCIO LL1570 COMPLETA	CONNECTING ROD COMPLETE FIRST- SECOND BOOM LL1570	BIELLE	PLEUELSTANGE	BIELA
6	177114J2	BIELLA PRIMO- SECONDO BRACCIO	ROD FIRST-SECOND BOOM	BIELLE	PLEUELSTANGE	BIELLE
7	07765100	BOCCOLA DEVA.TEX552 354040	BUSH DEVA. TEX 552 354040	DOUILLE	BUCHSE	CASQUILLO
8	07755000	SPINA FONDELLO CILINDRO 1°2°BRACCIO LL1570- X15JP-X430AJ	PIN BOTTOM CYLINDER 1ST 2ND ARM LL1570-X15JP- X430AJ	AXE	STIFT	CLAVIJA
9	177590A6	PRIMO BRACCIO LL1570 COMPLETO	FIRST COMPLETE BOOM LL1570	PREMIER BRAS	ERSTER ARM	PRIMERO BRAZO
9	177590A7	PRIMO BRACCIO LL1570 COMPLETO	FIRST COMPLETE BOOM LL1570	PREMIER BRAS	ERSTER ARM	PRIMERO BRAZO



Main color codes:  J1 - JLG Cream,  J2 - JLG Orange,  C4 - Green

 PRIMO BRACCIO

 FIRST ARM

 PREMIER BRAS
ERSTER AUSLEGERARM PRIMO BRAZO 

POS	Codice	 Descrizione	 Description	 Designation	 Benennung	 Descripción
9	177590A8	PRIMO BRACCIO LL1570 COMPLETO	FIRST COMPLETE BOOM LL1570	PREMIER BRAS	ERSTER ARM	PRIMERO BRAZO
9	177590B1	PRIMO BRACCIO LL1570 COMPLETO	FIRST COMPLETE BOOM LL1570	PREMIER BRAS	ERSTER ARM	PRIMERO BRAZO
9	177590B6	PRIMO BRACCIO LL1570 COMPLETO	FIRST COMPLETE BOOM LL1570	PREMIER BRAS	ERSTER ARM	PRIMERO BRAZO
9	177590BP	PRIMO BRACCIO LL1570 COMPLETO	FIRST COMPLETE BOOM LL1570	PREMIER BRAS	ERSTER ARM	PRIMERO BRAZO
9	177590BR	PRIMO BRACCIO LL1570 COMPLETO	FIRST COMPLETE BOOM LL1570	PREMIER BRAS	ERSTER ARM	PRIMERO BRAZO
9	177590C4	PRIMO BRACCIO LL1570 COMPLETO	FIRST COMPLETE BOOM LL1570	PREMIER BRAS	ERSTER ARM	PRIMERO BRAZO
9	177590FX	PRIMO BRACCIO LL1570 COMPLETO	FIRST COMPLETE BOOM LL1570	PREMIER BRAS	ERSTER ARM	PRIMERO BRAZO
9	177590GB	PRIMO BRACCIO LL1570 COMPLETO	FIRST COMPLETE BOOM LL1570	PREMIER BRAS	ERSTER ARM	PRIMERO BRAZO
9	177590H1	PRIMO BRACCIO COMPLETO	FIRST BOOM COMPLETE	PREMIER BRAS COMPLET	ERSTER ARM KOMPLETT	PRIMERO BRAZO COMPLETO
9	177590J1	PRIMO BRACCIO LL1570 COMPLETO	FIRST COMPLETE BOOM LL1570	PREMIER BRAS	ERSTER ARM	PRIMERO BRAZO
9	177590J2	PRIMO BRACCIO COMPLETO	FIRST BOOM COMPLETE	PREMIER BRAS COMPLET	ERSTER ARM KOMPLETT	PRIMERO BRAZO COMPLETO
10	07765000	BOCCOLA DEVA. TEX552 404540	BUSH DEVA. TEX 552 404540	DOUILLE	BUCHSE	CASQUILLO
11	064967Y1	GOCCIA SPINA	PIN DROP	BAISSE CHEVILLE	TROPFEN STIFT	CAÍDA CLAVIJA
12	177117A6	TIRANTE PRIMO BRACCIO LL1570 COMPLETO	TIE ROD BOOM COMPLETE FIRST LL1570	TIRANT PREMIER BRAS	SPANNSTANGE ERSTER ARM	TIRANTE PRIMERO BRAZO
12	177117A7	TIRANTE PRIMO BRACCIO LL1570 COMPLETO	TIE ROD BOOM COMPLETE FIRST LL1570	TIRANT PREMIER BRAS	SPANNSTANGE ERSTER ARM	TIRANTE PRIMERO BRAZO
12	177117A8	TIRANTE PRIMO BRACCIO LL1570 COMPLETO	TIE ROD BOOM COMPLETE FIRST LL1570	TIRANT PREMIER BRAS	SPANNSTANGE ERSTER ARM	TIRANTE PRIMERO BRAZO



Main color codes:  J1 - JLG Cream,  J2 - JLG Orange,  C4 - Green

 PRIMO BRACCIO

 FIRST ARM

 PREMIER BRAS
ERSTER AUSLEGERARM PRIMO BRAZO 



POS	Codice	 Descrizione	 Description	 Designation	 Benennung	 Descripción
12	177117B1	TIRANTE PRIMO BRACCIO LL1570 COMPLETO	TIE ROD BOOM COMPLETE FIRST LL1570	TIRANT PREMIER BRAS	SPANNSTANGE ERSTER ARM	TIRANTE PRIMERO BRAZO
12	177117B6	TIRANTE PRIMO BRACCIO LL1570 COMPLETO	TIE ROD BOOM COMPLETE FIRST LL1570	TIRANT PREMIER BRAS	SPANNSTANGE ERSTER ARM	TIRANTE PRIMERO BRAZO
12	177117BP	TIRANTE PRIMO BRACCIO LL1570 COMPLETO	TIE ROD BOOM COMPLETE FIRST LL1570	TIRANT PREMIER BRAS	SPANNSTANGE ERSTER ARM	TIRANTE PRIMERO BRAZO
12	177117BR	TIRANTE PRIMO BRACCIO LL1570 COMPLETO	TIE ROD BOOM COMPLETE FIRST LL1570	TIRANT PREMIER BRAS	SPANNSTANGE ERSTER ARM	TIRANTE PRIMERO BRAZO
12	177117C4	TIRANTE PRIMO BRACCIO LL1570 COMPLETO	TIE ROD BOOM COMPLETE FIRST LL1570	TIRANT	TURMGESTÄNGE	TIRANTE
12	177117FX	TIRANTE PRIMO BRACCIO LL1570 COMPLETO	TIE ROD BOOM COMPLETE FIRST LL1570	TIRANT PREMIER BRAS	SPANNSTANGE ERSTER ARM	TIRANTE PRIMERO BRAZO
12	177117GB	TIRANTE PRIMO BRACCIO LL1570 COMPLETO	TIE ROD BOOM COMPLETE FIRST LL1570	TIRANT PREMIER BRAS	SPANNSTANGE ERSTER ARM	TIRANTE PRIMERO BRAZO
12	177117H1	TIRANTE PRIMO BRACCIO	FIRST TIE BOOM	TIRANT	TURMGESTÄNGE	TIRANTE
12	177117J1	TIRANTE PRIMO BRACCIO LL1570 COMPLETO	TIE ROD BOOM COMPLETE FIRST LL1570	TIRANT PREMIER BRAS	SPANNSTANGE ERSTER ARM	TIRANTE PRIMERO BRAZO
12	177117J2	TIRANTE PRIMO BRACCIO	FIRST TIE BOOM	TIRANT	TURMGESTÄNGE	TIRANTE
13	2648910002	KIT GUARNIZIONI	SEAL KIT	KIT DE JOINTS	DICHTUNGSSATZ	KIT DE JUNTAS
14	07755200	PERNO ATTACCO BIELLA A 1°BRACCIO LL1570-X15JP-X430AJ	PIN CONNECTION ROD A 1ST ARM LL1570-X15JP-X430AJ	AXE	STIFT	CLAVIJA



Main color codes:  J1 - JLG Cream,  J2 - JLG Orange,  C4 - Green

 PRIMO BRACCIO

 FIRST ARM

 PREMIER BRAS
ERSTER AUSLEGERARM PRIMO BRAZO 

POS	Codice	 Descrizione	 Description	 Designation	 Benennung	 Descripción
15	07754900	PERNO ATTACCO TIRANTE 1°BRACCIO A RINVIO 1°2°BRACCIO LL1570- X15JP-X430AJ	PIN CONNECTION TIE 1ST ARM REFERENCE 1ST 2ND ARM LL1570- X15JP-X430AJ	AXE	STIFT	CLAVIJA
16	377429A6	SUPPORTO BRACCI LL1570 SALDATO	SUPPORT BOOMS LL1570 WELDED	SUPPORT DES BRAS LL1570 SOUDÉ	LL1570 GESCHWEISSTE HALTERUNG DER ÄRME	SOPORTE BRAZOS LL1570 SOLDADO
16	377429A7	SUPPORTO BRACCI LL1570 SALDATO	SUPPORT BOOMS LL1570 WELDED	SUPPORT DES BRAS LL1570 SOUDÉ	LL1570 GESCHWEISSTE HALTERUNG DER ÄRME	SOPORTE BRAZOS LL1570 SOLDADO
16	377429A8	SUPPORTO BRACCI LL1570 SALDATO	SUPPORT BOOMS LL1570 WELDED	SUPPORT DES BRAS LL1570 SOUDÉ	LL1570 GESCHWEISSTE HALTERUNG DER ÄRME	SOPORTE BRAZOS LL1570 SOLDADO
16	377429B1	SUPPORTO BRACCI LL1570 SALDATO	SUPPORT BOOMS LL1570 WELDED	SUPPORT DES BRAS LL1570 SOUDÉ	LL1570 GESCHWEISSTE HALTERUNG DER ÄRME	SOPORTE BRAZOS LL1570 SOLDADO
16	377429B6	SUPPORTO BRACCI LL1570 SALDATO	SUPPORT BOOMS LL1570 WELDED	SUPPORT DES BRAS LL1570 SOUDÉ	LL1570 GESCHWEISSTE HALTERUNG DER ÄRME	SOPORTE BRAZOS LL1570 SOLDADO
16	377429BP	SUPPORTO BRACCI LL1570 SALDATO	SUPPORT BOOMS LL1570 WELDED	SUPPORT DES BRAS LL1570 SOUDÉ	LL1570 GESCHWEISSTE HALTERUNG DER ÄRME	SOPORTE BRAZOS LL1570 SOLDADO
16	377429BR	SUPPORTO BRACCI LL1570 SALDATO	SUPPORT BOOMS LL1570 WELDED	SUPPORT DES BRAS LL1570 SOUDÉ	LL1570 GESCHWEISSTE HALTERUNG DER ÄRME	SOPORTE BRAZOS LL1570 SOLDADO



Main color codes:  J1 - JLG Cream,  J2 - JLG Orange,  C4 - Green

 PRIMO BRACCIO

 FIRST ARM

 PREMIER BRAS
ERSTER AUSLEGERARM PRIMO BRAZO 





POS	Codice	 Descrizione	 Description	 Designation	 Benennung	 Descripción
16	377429C4	SUPPORTO BRACCI LL1570 SALDATO	SUPPORT BOOMS LL1570 WELDED	SUPPORT BRAS	ÄRMEHALTERUNG	SOPORTE BRAZOS
16	377429FX	SUPPORTO BRACCI LL1570 SALDATO	SUPPORT BOOMS LL1570 WELDED	SUPPORT DES BRAS LL1570 SOUDÉ	LL1570 GESCHWEISSTE HALTERUNG DER ÄRME	SOPORTE BRAZOS LL1570 SOLDADO
16	377429GB	SUPPORTO BRACCI LL1570 SALDATO	SUPPORT BOOMS LL1570 WELDED	SUPPORT DES BRAS LL1570 SOUDÉ	LL1570 GESCHWEISSTE HALTERUNG DER ÄRME	SOPORTE BRAZOS LL1570 SOLDADO
16	377429H1	SUPPORTO BRACCI	BOOM SUPPORT	SUPPORT BRAS	ÄRMEHALTERUNG	SOPORTE BRAZOS
16	377429J1	SUPPORTO BRACCI LL1570 SALDATO	SUPPORT BOOMS LL1570 WELDED	SUPPORT DES BRAS LL1570 SOUDÉ	LL1570 GESCHWEISSTE HALTERUNG DER ÄRME	SOPORTE BRAZOS LL1570 SOLDADO
16	377429J2	SUPPORTO BRACCI	BOOM SUPPORT	SUPPORT BRAS	ÄRMEHALTERUNG	SOPORTE BRAZOS
17	060372Y2	FERMO	RETAINER	ARRÊT	HALTERUNG	SUJETADOR
18	07754700	PERNO ATTACCO 1° BRACCIO A SUPPORTO BRACCI LL1570-X15JP-X430AJ	PIN CONNECTION 1ST ARM SUPPORT ARMS LL1570-X15JP-X430AJ	AXE	STIFT	CLAVIJA
19	07754800	PERNO ATTACCO TIRANTE 1°BRACCIO A SUPPORTO BRACCI LL1570-X15JP-X430AJ	PIN CONNECTION TIE 1ST ARM SUPPORT ARMS LL1570-X15JP- X430AJ	AXE	STIFT	CLAVIJA
20	071531D2	INDICE ALLINEAMENTO	ALIGNMENT INDICATOR	INDICATEUR D'ALIGNEMENT	AUSRICHTUNGSANZE IGE	INDICADOR ALINEACIÓN
21	05849000	PATTINO	SLIDE BLOCK	PATIN	GLEITBLOCK	PATÍN
22	07771600	TAMPONE APPOGGIO PRIMO BRACCIO LL1570	BUFFER FOR SUPPORT FIRST ARM LL1570	TAMPON	PUFFER	TAMPÓN
23	069590H3	PROTEZIONE	PROTECTION	PROTECTION	SCHUTZ	PROTECCIÓN



Main color codes:  J1 - JLG Cream,  J2 - JLG Orange,  C4 - Green

 PRIMO BRACCIO





 FIRST ARM



 PREMIER BRAS
ERSTER AUSLEGERARM PRIMO BRAZO 



POS	Codice	 Descrizione	 Description	 Designation	 Benennung	 Descripción
24	077717H3	STAFFA FISSAGGIO MICRO PRIMO BRACCIO	BRACKET MICRO FIRST BOOM	BRIDE	BÜGEL	BRIDA
25	068912Y1	PERNO	PIN	GOUJON	ZAPFEN	PERNIO
26	064422Y1	FERMO	RETAINER	ARRÊT	HALTEVORRICHTUNG	BLOQUE
27	07539800	SPINA	PIN	AXE	STIFT	CLAVIJA
28	077556H3	PIEGATO FISSAGGIO DISTRIBUTORE LL1570	BENT FITTING DISTRIBUTOR LL1570	SUPPORT	HALTERUNG	SOPORTE
29	077558H2	PIEGATO ANTERIORE SUPPORTO DISTRIBUTORE	BENT FRONT SUPPORT DISTRIBUTOR	SUPPORT	HALTERUNG	SOPORTE
30	077557H2	PIEGATO POSTERIORE SUPPORTO DISTRIBUTORE	BENT BACK SUPPORT DISTRIBUTOR	SUPPORT	HALTERUNG	SOPORTE
31	373142A3	CARTER DISTRIBUTORE BRACCI (FOR LL1775- X17JP-X500AJ MK2 FROM C170000893)	CARTER BOOM HYDRAULIC DISTRIBUTOR (FOR LL1775-X17JP-X500AJ MK2 FROM C170000893)	CARTER DISTRIBUTEUR (FOR LL1775-X17JP-X500AJ MK2 FROM C170000893)	CARTER HÄNDLER (FOR LL1775-X17JP- X500AJ MK2 FROM C170000893)	CARTER DISTRIBUIDOR (FOR LL1775-X17JP-X500AJ MK2 FROM C170000893)
31	373142H2	CARTER DISTRIBUTORE BRACCI (FOR LL1775- X17JP-X500AJ MK2 FROM C170000893)	PROTECTION BOOM HYDRAULIC DISTRIBUTOR (FOR LL1775-X17JP-X500AJ MK2 FROM C170000893)	PROTECTION DISTRIBUTEUR (FOR LL1775-X17JP-X500AJ MK2 FROM C170000893)	SCHUTZ VENTILBLOCK (FOR LL1775-X17JP-X500AJ MK2 FROM C170000893)	PROTECCION DISTRIBUIDOR (FOR LL1775-X17JP-X500AJ MK2 FROM C170000893)
32	073144A3	COPERCHIO (FOR LL1775-X17JP-X500AJ MK2 FROM C170000893)	COVER (FOR LL1775- X17JP-X500AJ MK2 FROM C170000893)	COUVERTURE (FOR LL1775-X17JP-X500AJ MK2 FROM C170000893)	ABDECKUNG (FOR LL1775-X17JP-X500AJ MK2 FROM C170000893)	CUBIERTA (FOR LL1775-X17JP-X500AJ MK2 FROM C170000893)



Main color codes:  J1 - JLG Cream,  J2 - JLG Orange,  C4 - Green

 PRIMO BRACCIO FIRST ARM PREMIER BRASERSTER AUSLEGERARM PRIMO BRAZO 



POS	Codice	 Descrizione	 Description	 Designation	 Benennung	 Descripción
32	073144H2	COPERCHIO (FOR LL1775-X17JP-X500AJ MK2 FROM C170000893)	COVER (FOR LL1775-X17JP-X500AJ MK2 FROM C170000893)	COUVERTURE (FOR LL1775-X17JP-X500AJ MK2 FROM C170000893)	DECKUNG (FOR LL1775-X17JP-X500AJ MK2 FROM C170000893)	COBERTURA (FOR LL1775-X17JP-X500AJ MK2 FROM C170000893)
32	075059H2	COPERCHIO SENZA CHIAVE VERSIONE ANSI (FOR LL1775-X17JP-X500AJ MK2 FROM C170000893)	COVER WITHOUT KEY ANSI VERSION (FOR LL1775-X17JP-X500AJ MK2 FROM C170000893)	COUVERTURE SANS CLÉ (FOR LL1775-X17JP-X500AJ MK2 FROM C170000893)	DECKUNG OHNE SCHLÜSSEL (FOR LL1775-X17JP-X500AJ MK2 FROM C170000893)	COBERTURA SIN LLAVE (FOR LL1775-X17JP-X500AJ MK2 FROM C170000893)
33	07178800	SERRATURA	LOCK	SERRURE	SCHLOSS	CERRADURA
34	07298800	CHIAVE PER SERRATURA POSTAZIONE COMANDO A TERRA	KEY TO THE LOCK ON THE GROUND CONTROL POSITION	CLÉ	SCHLÜSSEL	LLAVE
35	07178900	CAMMA PER SERRATURA DISASSAMENTO 3.2	CAM LOCK FOR OFFSET 3.2	CAME	NOCKEN	LEVA
36	073138Y1	SUPPORTO SERRATURA	LOCK SUPPORT	SUPPORT SERRURE	SCHLOSSHALTERUNG	SOPORTE CERRADURA

Main color codes:  J1 - JLG Cream,  J2 - JLG Orange,  C4 - Green

-  SECONDO BRACCIO
-  SECOND ARM
-  SECOND BRAS

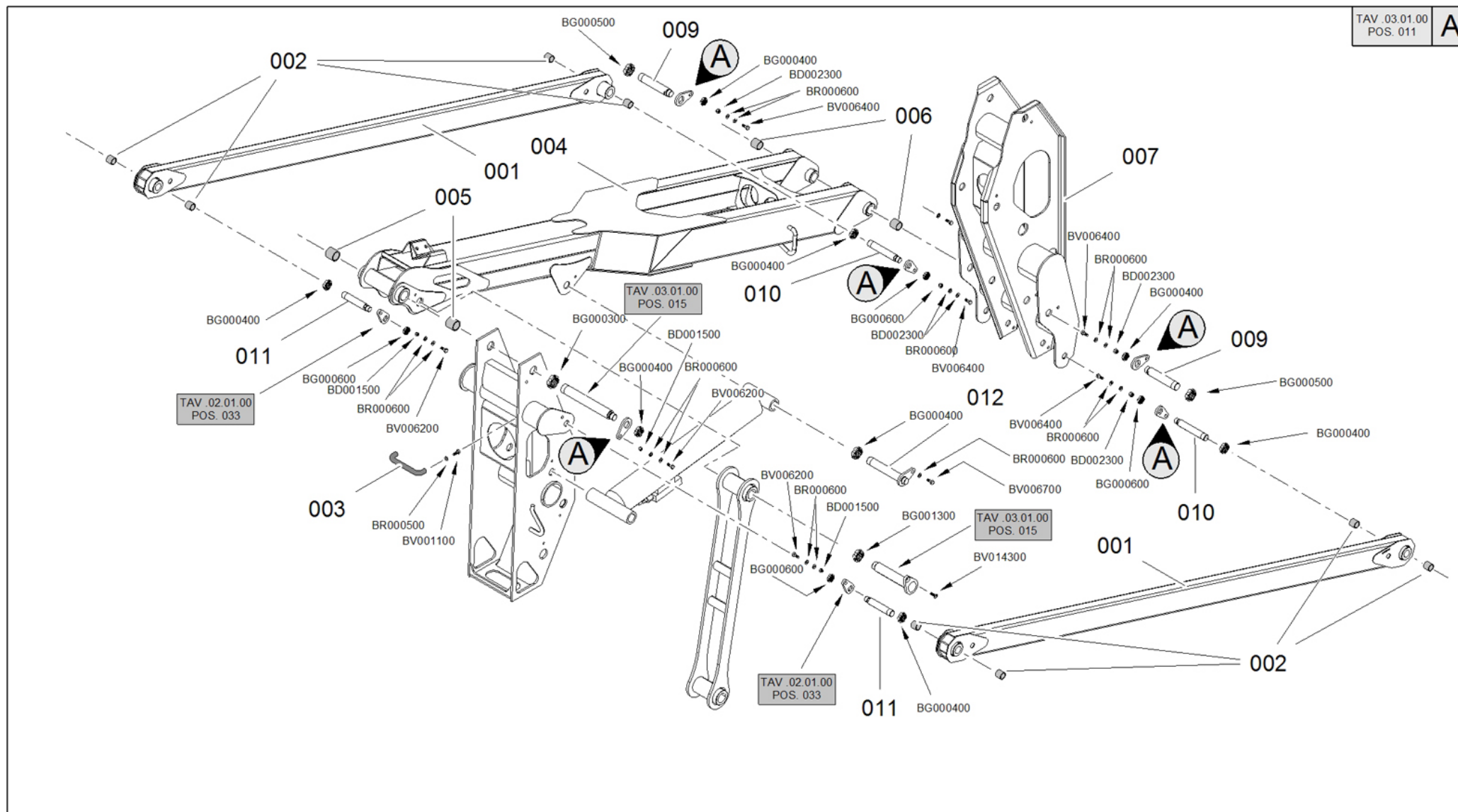
- ZWEITER AUSLEGERARM 
- SEGUNDO BRAZO 











Main color codes:  J1 - JLG Cream,  J2 - JLG Orange,  C4 - Green

 SECONDO BRACCIO

 SECOND ARM

 SECOND BRAS
ZWEITER AUSLEGERARM SEGUNDO BRAZO 



POS	Codice	 Descrizione	 Description	 Designation	 Benennung	 Descripción
1	177347A6	TIRANTE SECONDO BRACCIO LL1570 COMPLETO	TIE ROD COMPLETE SECOND BOOM LL1570	TIRANT DEUXIÈME BRAS	ZWEITER ARM TURMGESTÄNGE	TIRANTE SEGUNDO BRAZO
1	177347A7	TIRANTE SECONDO BRACCIO LL1570 COMPLETO	TIE ROD COMPLETE SECOND BOOM LL1570	TIRANT DEUXIÈME BRAS	ZWEITER ARM TURMGESTÄNGE	TIRANTE SEGUNDO BRAZO
1	177347A8	TIRANTE SECONDO BRACCIO LL1570 COMPLETO	TIE ROD COMPLETE SECOND BOOM LL1570	TIRANT DEUXIÈME BRAS	ZWEITER ARM TURMGESTÄNGE	TIRANTE SEGUNDO BRAZO
1	177347B1	TIRANTE SECONDO BRACCIO LL1570 COMPLETO	TIE ROD COMPLETE SECOND BOOM LL1570	TIRANT DEUXIÈME BRAS	ZWEITER ARM TURMGESTÄNGE	TIRANTE SEGUNDO BRAZO
1	177347B6	TIRANTE SECONDO BRACCIO LL1570 COMPLETO	TIE ROD COMPLETE SECOND BOOM LL1570	TIRANT DEUXIÈME BRAS	ZWEITER ARM TURMGESTÄNGE	TIRANTE SEGUNDO BRAZO
1	177347BP	TIRANTE SECONDO BRACCIO LL1570 COMPLETO	TIE ROD COMPLETE SECOND BOOM LL1570	TIRANT DEUXIÈME BRAS	ZWEITER ARM TURMGESTÄNGE	TIRANTE SEGUNDO BRAZO
1	177347BR	TIRANTE SECONDO BRACCIO LL1570 COMPLETO	TIE ROD COMPLETE SECOND BOOM LL1570	TIRANT DEUXIÈME BRAS	ZWEITER ARM TURMGESTÄNGE	TIRANTE SEGUNDO BRAZO
1	177347C4	TIRANTE SECONDO BRACCIO LL1570 COMPLETO	TIE ROD COMPLETE SECOND BOOM LL1570	TIRANT	TURMGESTÄNGE	TIRANTE
1	177347FX	TIRANTE SECONDO BRACCIO LL1570 COMPLETO	TIE ROD COMPLETE SECOND BOOM LL1570	TIRANT DEUXIÈME BRAS	ZWEITER ARM TURMGESTÄNGE	TIRANTE SEGUNDO BRAZO
1	177347GB	TIRANTE SECONDO BRACCIO LL1570 COMPLETO	TIE ROD COMPLETE SECOND BOOM LL1570	TIRANT DEUXIÈME BRAS	ZWEITER ARM TURMGESTÄNGE	TIRANTE SEGUNDO BRAZO
1	177347H1	TIRANTE SECONDO BRACCIO	SECOND TIE BOOM	TIRANT	TURMGESTÄNGE	TIRANTE



Main color codes:  J1 - JLG Cream,  J2 - JLG Orange,  C4 - Green

 SECONDO BRACCIO

 SECOND ARM

 SECOND BRAS
ZWEITER AUSLEGERARM SEGUNDO BRAZO 



POS	Codice	 Descrizione	 Description	 Designation	 Benennung	 Descripción
1	177347J1	TIRANTE SECONDO BRACCIO LL1570 COMPLETO	TIE ROD COMPLETE SECOND BOOM LL1570	TIRANT DEUXIÈME BRAS	ZWEITER ARM TURMGESTÄNGE	TIRANTE SEGUNDO BRAZO
1	177347J2	TIRANTE SECONDO BRACCIO	SECOND TIE BOOM	TIRANT	TURMGESTÄNGE	TIRANTE
2	07765300	BOCCOLA DEVA.TEX552 253030	BUSH DEVA. TEX 552 253030	DOUILLE	BUCHSE	CASQUILLO
3	07154000	MANIGLIA	HANDLE	POIGNÉE	GRIFF	MANIJA
4	177610A6	SECONDO BRACCIO LL1570 COMPLETO	SECOND BOOM COMPLETE LL1570	DEUMIÈME BRAS	ZWEITER ARM	SEGUNDO BRAZO
4	177610A7	SECONDO BRACCIO LL1570 COMPLETO	SECOND BOOM COMPLETE LL1570	DEUMIÈME BRAS	ZWEITER ARM	SEGUNDO BRAZO
4	177610A8	SECONDO BRACCIO LL1570 COMPLETO	SECOND BOOM COMPLETE LL1570	DEUMIÈME BRAS	ZWEITER ARM	SEGUNDO BRAZO
4	177610B1	SECONDO BRACCIO LL1570 COMPLETO	SECOND BOOM COMPLETE LL1570	DEUMIÈME BRAS	ZWEITER ARM	SEGUNDO BRAZO
4	177610B6	SECONDO BRACCIO LL1570 COMPLETO	SECOND BOOM COMPLETE LL1570	DEUMIÈME BRAS	ZWEITER ARM	SEGUNDO BRAZO
4	177610BP	SECONDO BRACCIO LL1570 COMPLETO	SECOND BOOM COMPLETE LL1570	DEUMIÈME BRAS	ZWEITER ARM	SEGUNDO BRAZO
4	177610BR	SECONDO BRACCIO LL1570 COMPLETO	SECOND BOOM COMPLETE LL1570	DEUMIÈME BRAS	ZWEITER ARM	SEGUNDO BRAZO
4	177610C4	SECONDO BRACCIO LL1570 COMPLETO	SECOND BOOM COMPLETE LL1570	DEUXIÈME BRAS	ZWEITER ARM	SEGUNDO BRAZO
4	177610FX	SECONDO BRACCIO LL1570 COMPLETO	SECOND BOOM COMPLETE LL1570	DEUMIÈME BRAS	ZWEITER ARM	SEGUNDO BRAZO
4	177610GB	SECONDO BRACCIO LL1570 COMPLETO	SECOND BOOM COMPLETE LL1570	DEUMIÈME BRAS	ZWEITER ARM	SEGUNDO BRAZO
4	177610H1	SECONDO BRACCIO COMPLETO	SECOND BOOM COMPLETE	DEUXIEME BRAS COMPLET	ZWEITER ARM KOMPLETT	SEGUNDO BRAZO COMPLETO
4	177610J1	SECONDO BRACCIO LL1570 COMPLETO	SECOND BOOM COMPLETE LL1570	DEUMIÈME BRAS	ZWEITER ARM	SEGUNDO BRAZO
4	177610J2	SECONDO BRACCIO COMPLETO	SECOND BOOM COMPLETE	DEUXIEME BRAS COMPLET	ZWEITER ARM KOMPLETT	SEGUNDO BRAZO COMPLETO



Main color codes:  J1 - JLG Cream,  J2 - JLG Orange,  C4 - Green

 SECONDO BRACCIO

 SECOND ARM

 SECOND BRAS
ZWEITER AUSLEGERARM SEGUNDO BRAZO 





POS	Codice	 Descrizione	 Description	 Designation	 Benennung	 Descripción
5	07765100	BOCCOLA DEVA.TEX552 354040	BUSH DEVA. TEX 552 354040	DOUILLE	BUCHSE	CASQUILLO
6	07765200	BOCCOLA DEVA.TEX552 303530	BUSH DEVA. TEX 552 303530	DOUILLE	BUCHSE	CASQUILLO
7	377352A6	RINVIO SECONDO- TERZO BRACCIO LL1570 SALDATO	REFERENCE SECOND- THIRD BOOM LL1570 WELDED	RENVOI DEUXIÈME BRAS	ZWEITER ARM VORGELEGE	REENVIO SEGUNDO BRAZO
7	377352A7	RINVIO SECONDO- TERZO BRACCIO LL1570 SALDATO	REFERENCE SECOND- THIRD BOOM LL1570 WELDED	RENVOI DEUXIÈME BRAS	ZWEITER ARM VORGELEGE	REENVIO SEGUNDO BRAZO
7	377352A8	RINVIO SECONDO- TERZO BRACCIO LL1570 SALDATO	REFERENCE SECOND- THIRD BOOM LL1570 WELDED	RENVOI DEUXIÈME BRAS	ZWEITER ARM VORGELEGE	REENVIO SEGUNDO BRAZO
7	377352B1	RINVIO SECONDO- TERZO BRACCIO LL1570 SALDATO	REFERENCE SECOND- THIRD BOOM LL1570 WELDED	RENVOI DEUXIÈME BRAS	ZWEITER ARM VORGELEGE	REENVIO SEGUNDO BRAZO
7	377352B6	RINVIO SECONDO- TERZO BRACCIO LL1570 SALDATO	REFERENCE SECOND- THIRD BOOM LL1570 WELDED	RENVOI DEUXIÈME BRAS	ZWEITER ARM VORGELEGE	REENVIO SEGUNDO BRAZO
7	377352BP	RINVIO SECONDO- TERZO BRACCIO LL1570 SALDATO	REFERENCE SECOND- THIRD BOOM LL1570 WELDED	RENVOI DEUXIÈME BRAS	ZWEITER ARM VORGELEGE	REENVIO SEGUNDO BRAZO
7	377352BR	RINVIO SECONDO- TERZO BRACCIO LL1570 SALDATO	REFERENCE SECOND- THIRD BOOM LL1570 WELDED	RENVOI DEUXIÈME BRAS	ZWEITER ARM VORGELEGE	REENVIO SEGUNDO BRAZO
7	377352C4	RINVIO SECONDO- TERZO BRACCIO LL1570 SALDATO	REFERENCE SECOND- THIRD BOOM LL1570 WELDED	RENVOI	VORGELEGE	REENVIO
7	377352FX	RINVIO SECONDO- TERZO BRACCIO LL1570 SALDATO	REFERENCE SECOND- THIRD BOOM LL1570 WELDED	RENVOI DEUXIÈME BRAS	ZWEITER ARM VORGELEGE	REENVIO SEGUNDO BRAZO
7	377352GB	RINVIO SECONDO- TERZO BRACCIO LL1570 SALDATO	REFERENCE SECOND- THIRD BOOM LL1570 WELDED	RENVOI DEUXIÈME BRAS	ZWEITER ARM VORGELEGE	REENVIO SEGUNDO BRAZO



Main color codes:  J1 - JLG Cream,  J2 - JLG Orange,  C4 - Green



 SECONDO BRACCIO



 SECOND ARM

 SECOND BRAS
ZWEITER AUSLEGERARM SEGUNDO BRAZO 



POS	Codice	 Descrizione	 Description	 Designation	 Benennung	 Descripción
7	377352H1	RINVIO SECONDO-TERZO BRACCIO	REFERENCE SECOND-THIRD BOOM	RENOI DEUXIEME-TROISIEME BRAS	VORGELEGE ZWEITER-DRITTER ARM	REENVIO SEGUNDO-TERZERO BRAZO
7	377352J1	RINVIO SECONDO-TERZO BRACCIO LL1570 SALDATO	REFERENCE SECOND-THIRD BOOM LL1570 WELDED	RENOI DEUXIÈME BRAS	ZWEITER ARM VORGELEGE	REENVIO SEGUNDO BRAZO
7	377352J2	RINVIO SECONDO-TERZO BRACCIO	REFERENCE SECOND-THIRD BOOM	RENOI DEUXIEME-TROISIEME BRAS	VORGELEGE ZWEITER-DRITTER ARM	REENVIO SEGUNDO-TERCERO BRAZO
9	07755300	PERNO ATTACCO TIRANTE 2°BRACCIO A RINVIO 2°3°BRACCIO LL1570-X15JP-X430AJ	PIN CONNECTION ROD 2ND ARM REFERENCE 2ND 3RD ARM LL1570-X15JP-X430AJ	AXE	STIFT	CLAVIJA
10	07271600	SPINA	PIN	CHEVILLE	STIF	CLAVIJA
11	07755100	PERNO ATTACCO TIRANTE 2°BRACCIO A RINVIO 1°2°BRACCIO LL1570-X15JP-X430AJ	PIN CONNECTION ROD 2ND ARM REFERENCE 1ST 2ND ARM LL1570-X15JP-X430AJ	AXE	STIFT	CLAVIJA
12	07093900	SPINA	PIN	CHEVILLE	STIF	CLAVIJA

Main color codes:  J1 - JLG Cream,  J2 - JLG Orange,  C4 - Green

-  TERZO BRACCIO
-  THIRD ARM
-  TIERS BRAS

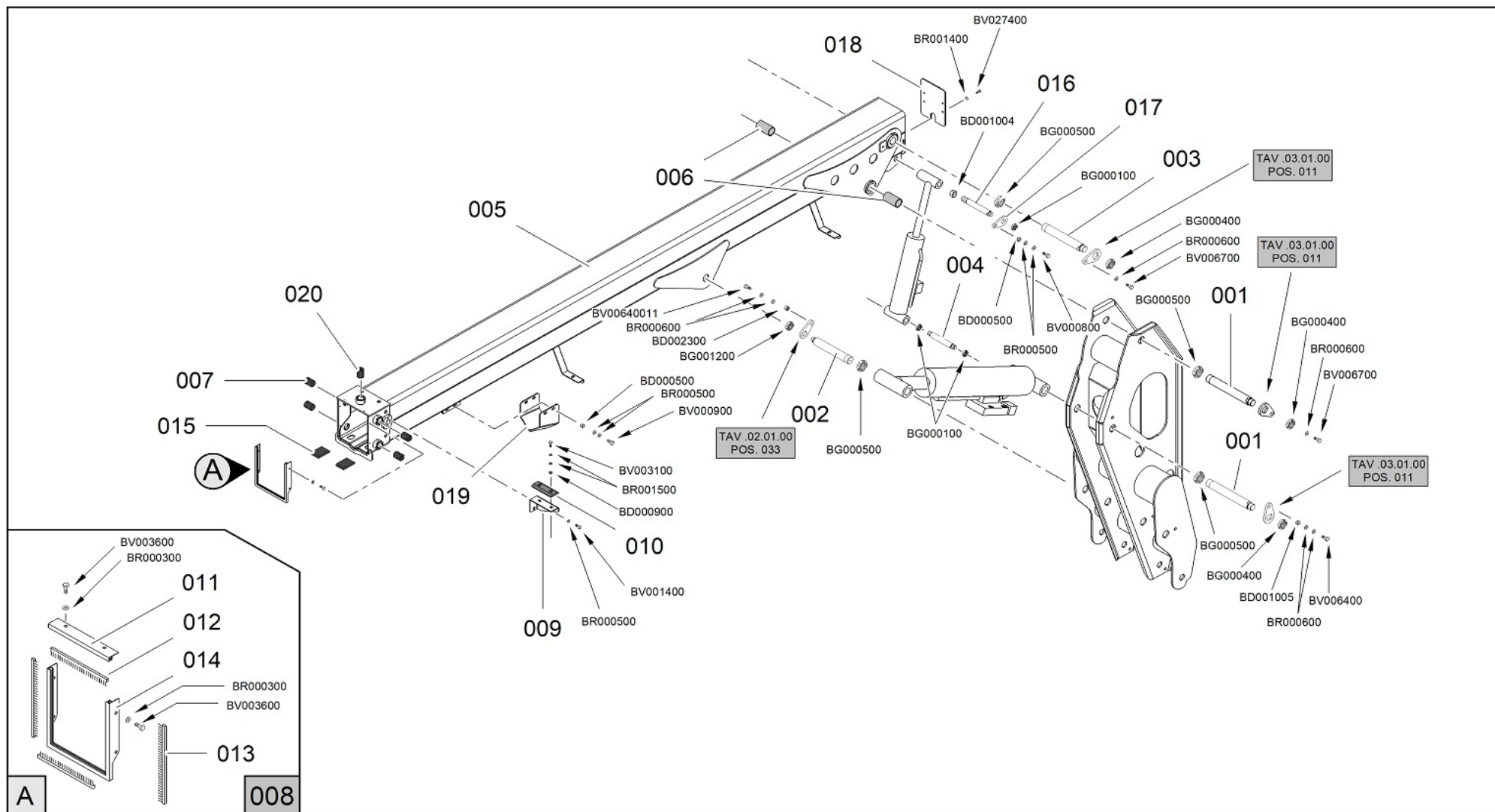
THIRD AUSLEGERARM 
 TERCERO BRAZO 











Main color codes:  J1 - JLG Cream,  J2 - JLG Orange,  C4 - Green

 TERZO BRACCIO

 THIRD ARM

 TIERS BRAS
THIRD AUSLEGERARM TERCERO BRAZO 





POS	Codice	 Descrizione	 Description	 Designation	 Benennung	 Descripción
1	07094900	SPINA	PIN	CHEVILLE	STIF	CLAVIJA
1	077380H3	PIEGATO CENTRAGGIO TERZO BRACCIO LL1570	BENDED CENTRING THIRD BOOM LL1570	SUPPORT	HALTERUNG	SOPORTE
2	06561000	SPINA	PIN	CHEVILLE	STIF	CLAVIJA
3	07102500	SPINA	PIN	CHEVILLE	STIF	CLAVIJA
4	06867600	SPINA	PIN	CHEVILLE	STIFT	CLAVIJA
5	177366A6	TERZO BRACCIO LL1570 COMPLETO	THIRD BOOM COMPLETE LL1570	TROISIÈME BRAS	DRITTER ARM	TERCERO BRAZO
5	177366A7	TERZO BRACCIO LL1570 COMPLETO	THIRD BOOM COMPLETE LL1570	TROISIÈME BRAS	DRITTER ARM	TERCERO BRAZO
5	177366A8	TERZO BRACCIO LL1570 COMPLETO	THIRD BOOM COMPLETE LL1570	TROISIÈME BRAS	DRITTER ARM	TERCERO BRAZO
5	177366B1	TERZO BRACCIO LL1570 COMPLETO	THIRD BOOM COMPLETE LL1570	TROISIÈME BRAS	DRITTER ARM	TERCERO BRAZO
5	177366B6	TERZO BRACCIO LL1570 COMPLETO	THIRD BOOM COMPLETE LL1570	TROISIÈME BRAS	DRITTER ARM	TERCERO BRAZO
5	177366BP	TERZO BRACCIO LL1570 COMPLETO	THIRD BOOM COMPLETE LL1570	TROISIÈME BRAS	DRITTER ARM	TERCERO BRAZO
5	177366BR	TERZO BRACCIO LL1570 COMPLETO	THIRD BOOM COMPLETE LL1570	TROISIÈME BRAS	DRITTER ARM	TERCERO BRAZO
5	177366C4	TERZO BRACCIO LL1570 COMPLETO	THIRD BOOM COMPLETE LL1570	TROISIÈME BRAS	DRITTER ARM	TERCERO BRAZO
5	177366FX	TERZO BRACCIO LL1570 COMPLETO	THIRD BOOM COMPLETE LL1570	TROISIÈME BRAS	DRITTER ARM	TERCERO BRAZO
5	177366GB	TERZO BRACCIO LL1570 COMPLETO	THIRD BOOM COMPLETE LL1570	TROISIÈME BRAS	DRITTER ARM	TERCERO BRAZO
5	177366H1	TERZO BRACCIO COMPLETO	THIRD BOOM COMPLETE	TROISIEME BRAS COMPLET	DRITTER ARM KOMPLETT	TERCERO BRAZO COMPLETO
5	177366J1	TERZO BRACCIO LL1570 COMPLETO	THIRD BOOM COMPLETE LL1570	TROISIÈME BRAS	DRITTER ARM	TERCERO BRAZO
5	177366J2	TERZO BRACCIO COMPLETO	THIRD BOOM COMPLETE	TROISIEME BRAS COMPLET	DRITTER ARM KOMPLETT	TERCERO BRAZO COMPLETO



Main color codes:  J1 - JLG Cream,  J2 - JLG Orange,  C4 - Green

 TERZO BRACCIO

 THIRD ARM

 TIERS BRAS
THIRD AUSLEGERARM TERCERO BRAZO 



POS	Codice	 Descrizione	 Description	 Designation	 Benennung	 Descripción
6	07765200	BOCCOLA DEVA.TEX552 303530	BUSH DEVA.TEX 552 303530	DOUILLE	BUCHSE	CASQUILLO
7	06958600	PATTINO	SLIDE BLOCK	PATIN	GLEITBLOCK	PATÍN
8	17767600	KIT SPAZZOLE TERZO BRACCIO LL2010	BRUSHES KIT	KIT BROSSES	BÜRSTENSATZ	KIT CEPILLOS
9	068663H3	SUPPORTO	SUPPORT	SUPPORT	HALTERUNG	SOPORTE
10	06867100	PATTINO	SLIDE BLOCK	PATIN	GLEITBLOCK	PATÍN
11	07101600	PROFILO SPAZZOLE SUPERIORE	PROFILE BRUSH TOP	CHÂSSIS	RAHMEN	BASTIDOR
12	07102000	SPAZZOLA ORRIZONTALE	HORIZONTAL BRUSH	BROSSE HORIZONTALE	WAAGRECHTE BÜRSTE	CEPILLO HORIZONTAL
13	07102100	SPAZZOLA VERTICALE	VERTICAL BRUSH	BROSSE VERTICALE	SENKRECHTE BÜRSTE	CEPILLO VERTICAL
14	07754300	PIEGATO FISSAGGIO SPAZZOLE	BENT FITTING BRUSHES	SUPPORT	HALTERUNG	SOPORTE
15	07754200	PATTINO APPOGGIO SFILO SU TERZO BRACCIO LL1570	SKID SUPPORT EXTENSION ON THIRD BOOM LL1570	PATIN	GLEITSCHUH	PATÍN
16	06230600	SPINA	PIN	CHEVILLE	STIFT	CLAVIJA
17	064965Y1	GOCCIA SPINA	PIN DROP	BAISSE CHEVILLE	TROPFEN	CAÍDA CLAVIJA
18	077536H3	CARTER POSTERIORE TERZO BRACCIO	CARTER BACK THIRD BOOM	CARTER	KURBELGEHÄUSE	CÁRTER
19	077380A6	PIEGATO CENTRAGGIO TERZO BRACCIO LL1570	BENDED CENTRING THIRD BOOM LL1570	SUPPORT	HALTERUNG	SOPORTE
19	077380H3	PIEGATO CENTRAGGIO TERZO BRACCIO LL1570	BENDED CENTRING THIRD BOOM LL1570	SUPPORT	HALTERUNG	SOPORTE
20	05804700	PATTINO	SLIDE BLOCK	PATIN	GLEITBLOCK	PATÍN





Main color codes:  J1 - JLG Cream,  J2 - JLG Orange,  C4 - Green



 CATENA PORTACAVI FLESSIBILE

 FLEXIBLE CABLE-HOLDER CHAIN

 CHAÎNE PORTE-CABLES FLEXIBLE

 SCHLAUCH SCHLEPPKETTE 
 CADENA PORTACABLES FLEXIBLE 



POS	Codice	 Descrizione	 Description	 Designation	 Benennung	 Descripción
1	177104A6	BRACCIO SFILO LL1570 COMPLETO	COMPLETE BOOM EXTENSION	BRAS D'EXTENSION	TELESKOP ARM	BRAZO TELESCÓPICO
1	177104A7	BRACCIO SFILO LL1570 COMPLETO	COMPLETE BOOM EXTENSION	BRAS D'EXTENSION	TELESKOP ARM	BRAZO TELESCÓPICO
1	177104A8	BRACCIO SFILO LL1570 COMPLETO	COMPLETE BOOM EXTENSION	BRAS D'EXTRACTION	AUSLEGER ARM	BRAZO DE EXTENSIÓN
1	177104B1	BRACCIO SFILO LL1570 COMPLETO	COMPLETE BOOM EXTENSION	BRAS D'EXTRACTION	AUSLEGER ARM	BRAZO DE EXTENSIÓN
1	177104BP	BRACCIO SFILO LL1570 COMPLETO	COMPLETE BOOM EXTENSION	BRAS D'EXTRACTION	AUSLEGER ARM	BRAZO DE EXTENSIÓN
1	177104BR	BRACCIO SFILO LL1570 COMPLETO	COMPLETE BOOM EXTENSION	BRAS D'EXTRACTION	AUSLEGER ARM	BRAZO DE EXTENSIÓN
1	177104C4	BRACCIO SFILO LL1570 COMPLETO	COMPLETE BOOM EXTENSION	BRAS D'EXTENSION	TELESKOPARM	BRAZO DE EXTENSIÓN
1	177104CD	BRACCIO SFILO LL1570 COMPLETO	COMPLETE BOOM EXTENSION	BRAS D'EXTENSION	ARMVERLÄNGERUNG	BRAZO DE EXTENSIÓN
1	177104FX	BRACCIO SFILO LL1570 COMPLETO	COMPLETE BOOM EXTENSION	BRAS D'EXTENSION	ARMVERLÄNGERUNG	BRAZO DE EXTENSIÓN
1	177104GB	BRACCIO SFILO LL1570 COMPLETO	COMPLETE BOOM EXTENSION	BRAS D'EXTRACTION	AUSLEGER ARM	BRAZO DE EXTENSIÓN
1	177104H1	BRACCIO SFILO COMPLETO	COMPLETE EXTENSION BOOM	BRAS D'EXTENSION	ARMVERLÄNGERUNG	BRAZO TELESCÓPICO
1	177104J2	BRACCIO SFILO LL1570 COMPLETO	COMPLETE BOOM EXTENSION	BRAS D'EXTENSION	ARMVERLÄNGERUNG	BRAZO DE EXTENSIÓN
2	377362H3	ASSIEME SUPPORTO CATENARIA SFILO LL1570 SALDATO	ASSEMBLY SUPPORT CONTACT LINE EXTENSION LL1570 WELDED	SUPPORT	HALTERUNG	SOPORTE
3	07767500	PATTINO GUIDA CILINDRO SFILO LL1570	SKID GUIDE CYLINDER EXTENSION LL1570	PATIN	GLEITSCHUH	PATÍN
4	07765800	BOCCOLA DEVA.TEX552 202815	BUSH DEVA.TEX 552 202815	DOUILLE	BUCHSE	CASQUILLO
5	07178200	PATTINO	SLIDE BLOCK	PATIN	GLEITBLOCK	PATÍN





 Main color codes:  J1 - JLG Cream,  J2 - JLG Orange,  C4 - Green

 CATENA PORTACAVI FLESSIBILE

 FLEXIBLE CABLE-HOLDER CHAIN

 CHAÎNE PORTE-CABLES FLEXIBLE





 SCHLAUCH SCHLEPPKETTE 
 CADENA PORTACABLES FLEXIBLE 



POS	Codice	 Descrizione	 Description	 Designation	 Benennung	 Descripció
6	07711300	PATTINO	SLIDE BLOCK	PATIN	GLEITBLOCK	PATÍN
7	06853800	SPINA	PIN	CHEVILLE	STIF	CLAVIJA
8	07530500	MORSETTO FERMA TUBI	CLAMP	ÉTAU	KLEMME	ABRAZADERA
9	077534H3	PIEGATO SUPPORTO CATENARIA SFILO LL1570	BENDED WIRE SUPPORT CATENARY LL1570	SUPPORT	HALTERUNG	SOPORTE
10	071314H3	COPERCHIO ANTERIORE SFILO	FRONT COVER EXTENSION	COUVERCLE	DECKEL	TAPA
11	27766400	CATENA PORTACAVI	CABLE-HOLDER CHAIN	CHAÎNE PORTE-CÂBLES	KABELHALTERKETTE	CADENA PORTACABLES
12	2595050004	COPERCHIO	COVER	COUVERCLE	DECKEL	TAPA
13	2595050001	MAGLIA CATENA ATTACCO FEMMINA	CHAIN LINK FEMALE CONNECTION	MAILLOT CHAÎNE	KETTENGLIED	ESLABÓN CADENA
14	2595050002	MAGLIA CATENA ATTACCO MASCHIO	CHAIN LINK MALE CONNECTION	MAILLOT CHAÎNE	KETTENGLIED	ESLABÓN CADENA
15	2595050003	MAGLIA CATENA	CHAIN LINK	MAILLOT CHAÎNE	KETTENGLIED	ESLABÓN CADENA
16	072263H3	STAFFA	BRACKET	ÉTRIER	HALTEBÜGEL	ESTRIBO
17	04096600	PIASTRA	CLAMP	BRIDE	KLEMME	PLACA
18	04096800	MORSETTO	CLAMP	BRIDE	KLEMME	BORNE

 SUPPORTO CESTO

 BASKET SUPPORT

 PANIER CUPPORT
HALTERUNG ARBEITSKORB SOPORTE CESTA 





POS	Codice	 Descrizione	 Description	 Designation	 Benennung	 Descripción
1	177718A6	ASSIEME BRACCIO JIB DESTRO COMPLETO	ASSEMBLY BOOM JIB RIGHT COMPLETE	BRAS JIB DROIT	RECHTER JIB ARM	BRAZO JIB DERECHO
1	177718A7	ASSIEME BRACCIO JIB DESTRO COMPLETO	ASSEMBLY BOOM JIB RIGHT COMPLETE	BRAS JIB DROIT	RECHTER JIB ARM	BRAZO JIB DERECHO
1	177718A8	ASSIEME BRACCIO JIB DESTRO COMPLETO	ASSEMBLY BOOM JIB RIGHT COMPLETE	BRAS JIB DROIT	RECHTER JIB ARM	BRAZO JIB DERECHO
1	177718B1	ASSIEME BRACCIO JIB DESTRO COMPLETO	ASSEMBLY BOOM JIB RIGHT COMPLETE	BRAS JIB DROIT	RECHTER JIB ARM	BRAZO JIB DERECHO
1	177718BP	ASSIEME BRACCIO JIB DESTRO COMPLETO	ASSEMBLY BOOM JIB RIGHT COMPLETE	BRAS JIB DROIT	RECHTER JIB ARM	BRAZO JIB DERECHO
1	177718BR	ASSIEME BRACCIO JIB DESTRO COMPLETO	ASSEMBLY BOOM JIB RIGHT COMPLETE	BRAS JIB DROIT	RECHTER JIB ARM	BRAZO JIB DERECHO
1	177718C4	ASSIEME BRACCIO JIB DESTRO COMPLETO	ASSEMBLY BOOM JIB RIGHT COMPLETE	BRAS JIB	JIB ARM	BRAZO JIB
1	177718CD	ASSIEME BRACCIO JIB DESTRO COMPLETO	ASSEMBLY BOOM JIB RIGHT COMPLETE	BRAS JIB DROIT	RECHTER JIB ARM	BRAZO JIB DERECHO
1	177718FX	ASSIEME BRACCIO JIB DESTRO COMPLETO	ASSEMBLY BOOM JIB RIGHT COMPLETE	BRAS JIB DROIT	RECHTER JIB ARM	BRAZO JIB DERECHO
1	177718GB	ASSIEME BRACCIO JIB DESTRO COMPLETO	ASSEMBLY BOOM JIB RIGHT COMPLETE	BRAS JIB DROIT	RECHTER JIB ARM	BRAZO JIB DERECHO
1	177718H1	ASSIEME BRACCIO JIB DESTRO COMPLETO	ASSEMBLY BOOM JIB RIGHT COMPLETE	BRAS JIB DROIT COMPLET	RECHTER JIB ARM KOMPLETT	BRAZO JIB DERECHO COMPLETO



Main color codes:  J1 - JLG Cream,  J2 - JLG Orange,  C4 - Green

 SUPPORTO CESTO

 BASKET SUPPORT

 PANIER CUPPORT
HALTERUNG ARBEITSKORB SOPORTE CESTA 





POS	Codice	 Descrizione	 Description	 Designation	 Benennung	 Descripción
1	177718J2	ASSIEME BRACCIO JIB DESTRO COMPLETO	ASSEMBLY BOOM JIB RIGHT COMPLETE	BRAS JIB DROIT	RECHTER JIB ARM	BRAZO JIB DERECHO
2	07765600	BOCCOLA DEVA.TEX552 202820	BUSH DEVA.TEX 552 202820	DOUILLE	BUCHSE	CASQUILLO
3	07093500	SPINA	PIN	CHEVILLE	STIFT	CLAVIJA
4	07093800	SPINA	PIN	CHEVILLE	STIFT	CLAVIJA
5	359447A6	TIRANTE	TIE ROD	TIRANT	TURMGESTÄNGE	TIRANTE
5	359447A7	TIRANTE	TIE ROD	TIRANT	TURMGESTÄNGE	TIRANTE
5	359447A8	TIRANTE	TIE ROD	TIRANT	TURMGESTÄNGE	TIRANTE
5	359447B1	TIRANTE	TIE ROD	TIRANT	TURMGESTÄNGE	TIRANTE
5	359447BP	TIRANTE	TIE ROD	TIRANT	TURMGESTÄNGE	TIRANTE
5	359447BR	TIRANTE	TIE ROD	TIRANT	TURMGESTÄNGE	TIRANTE
5	359447C4	TIRANTE	TIE ROD	TIRANT	TURMGESTÄNGE	TIRANTE
5	359447CD	TIRANTE	TIE ROD	TIRANT	TURMGESTÄNGE	TIRANTE
5	359447FX	TIRANTE	TIE ROD	TIRANT	TURMGESTÄNGE	TIRANTE
5	359447GB	TIRANTE	TIE ROD	TIRANT	TURMGESTÄNGE	TIRANTE
5	359447H1	TIRANTE	TIE ROD	TIRANT	TURMGESTÄNGE	TIRANTE
5	359447J2	TIRANTE JIB	TIE ROD JIB	TIRANT	ZUGSTANGE	TIRANTE
6	07093600	SPINA	PIN	CHEVILLE	STIFT	CLAVIJA
7	177719A6	ASSIEME BRACCIO JIB SINISTRO COMPLETO	ASSEMBLY BOOM JIB LEFT COMPLETE	BRAS JIB GAUCHE	LINKER JIB ARM	BRAZO JIB IZQUIERDO
7	177719A7	ASSIEME BRACCIO JIB SINISTRO COMPLETO	ASSEMBLY BOOM JIB LEFT COMPLETE	BRAS JIB GAUCHE	LINKER JIB ARM	BRAZO JIB IZQUIERDO
7	177719A8	ASSIEME BRACCIO JIB SINISTRO COMPLETO	ASSEMBLY BOOM JIB LEFT COMPLETE	BRAS JIB GAUCHE	LINKER JIB ARM	BRAZO JIB IZQUIERDO
7	177719B1	ASSIEME BRACCIO JIB SINISTRO COMPLETO	ASSEMBLY BOOM JIB LEFT COMPLETE	BRAS JIB GAUCHE	LINKER JIB ARM	BRAZO JIB IZQUIERDO



Main color codes:  J1 - JLG Cream,  J2 - JLG Orange,  C4 - Green

 SUPPORTO CESTO

 BASKET SUPPORT

 PANIER CUPPORT
HALTERUNG ARBEITSKORB SOPORTE CESTA 





POS	Codice	 Descrizione	 Description	 Designation	 Benennung	 Descripción
7	177719BP	ASSIEME BRACCIO JIB SINISTRO COMPLETO	ASSEMBLY BOOM JIB LEFT COMPLETE	BRAS JIB GAUCHE	LINKER JIB ARM	BRAZO JIB IZQUIERDO
7	177719BR	ASSIEME BRACCIO JIB SINISTRO COMPLETO	ASSEMBLY BOOM JIB LEFT COMPLETE	BRAS JIB GAUCHE	LINKER JIB ARM	BRAZO JIB IZQUIERDO
7	177719C4	ASSIEME BRACCIO JIB SINISTRO COMPLETO	ASSEMBLY BOOM JIB LEFT COMPLETE	BRAS JIB	JIB ARM	BRAZO JIB
7	177719CD	ASSIEME BRACCIO JIB SINISTRO COMPLETO	ASSEMBLY BOOM JIB LEFT COMPLETE	BRAS JIB GAUCHE	LINKER JIB ARM	BRAZO JIB IZQUIERDO
7	177719FX	ASSIEME BRACCIO JIB SINISTRO COMPLETO	ASSEMBLY BOOM JIB LEFT COMPLETE	BRAS JIB GAUCHE	LINKER JIB ARM	BRAZO JIB IZQUIERDO
7	177719GB	ASSIEME BRACCIO JIB SINISTRO COMPLETO	ASSEMBLY BOOM JIB LEFT COMPLETE	BRAS JIB GAUCHE	LINKER JIB ARM	BRAZO JIB IZQUIERDO
7	177719H1	ASSIEME BRACCIO JIB SINISTRO COMPLETO	ASSEMBLY BOOM JIB LEFT COMPLETE	BRAS JIB GAUCHE COMPLET	RECHTER JIB ARM KOMPLETT	BRAZO JIB IZQUIERDO COMPLETO
7	177719J2	ASSIEME BRACCIO JIB SINISTRO COMPLETO	ASSEMBLY BOOM JIB LEFT COMPLETE	BRAS JIB GAUCHE	LINKER JIB ARM	BRAZO JIB IZQUIERDO
8	377713H3	CAMMA MICRO JIB	MICROSWITCH CAM JIB	CAME	NOCKEN	LEVA
9	07093700	SPINA	PIN	CHEVILLE	STIFT	CLAVIJA
10	06235600	SPINA	PIN	CHEVILLE	STIFT	CLAVIJA
11	175401A6	RINVIO JIB	UPRIGHT JIB	RENVOI	VORGELEGE	REENVIO
11	175401A7	RINVIO JIB	UPRIGHT JIB	RENVOI	VORGELEGE	REENVIO
11	175401A8	RINVIO JIB	UPRIGHT JIB	RENVOI	VORGELEGE	REENVIO
11	175401B1	RINVIO JIB	UPRIGHT JIB	RENVOI	VORGELEGE	REENVIO
11	175401BP	RINVIO JIB	UPRIGHT JIB	RENVOI	VORGELEGE	REENVIO
11	175401BR	RINVIO JIB	UPRIGHT JIB	RENVOI	VORGELEGE	REENVIO



Main color codes:  J1 - JLG Cream,  J2 - JLG Orange,  C4 - Green

 SUPPORTO CESTO

 BASKET SUPPORT

 PANIER CUPPORT
HALTERUNG ARBEITSKORB SOPORTE CESTA 





POS	Codice	 Descrizione	 Description	 Designation	 Benennung	 Descripción
11	175401C4	RINVIO JIB	UPRIGHT JIB	RENOI	VORGELEGE	REENVIO
11	175401CD	RINVIO JIB	JIB CONNECTION ROD	RENOI	VORGELEGE	REENVIO
11	175401FX	RINVIO JIB	JIB CONNECTION ROD	RENOI	VORGELEGE	REENVIO
11	175401GB	RINVIO JIB	UPRIGHT JIB	RENOI	VORGELEGE	REENVIO
11	175401H1	RINVIO JIB	UPRIGHT JIB	RENOI	VORGELEGE	REENVIO
11	175401J2	RINVIO JIB	JIB CONNECTION ROD	RENOI	VORGELEGE	REENVIO
12	06235700	SPINA	PIN	CHEVILLE	STIFT	CLAVIJA
13	2648910002	KIT GUARNIZIONI	SEAL KIT	KIT DE JOINTS	DICHTUNGSSATZ	KIT DE JUNTAS
13	271778A6	ATTUATORE ROTANTE	ROTARY MOTOR	ROTARY ACTUATOR	SCHWENKEINHEIT	ACTUADOR ROTATIVO
13	271778H2	MOTORE DI ROTAZIONE	ROTARY MOTOR	MOTEUR DE ROTATION	DREHANTRIEB	MOTOR ROTACIÓN
14	377660A6	SUPPORTO CESTO	BASKET SUPPORT	SUPPORT PANIER	KORBHALTERUNG	SOPORTE CESTA
14	377660H2	SUPPORTO CESTO	BASKET SUPPORT	SUPPORT PANIER	KORBHALTERUNG	SOPORTE CESTA
15	056187H3	COPERCHIO	BOX	COUVERCLE	DECKEL	TAPA
16	07190900	VITE TE DIN960 CI 8.8 M16X1.5X115 FORATA GEOMET321 PLUS XL	TE SCREW DIN960 CI 8.8 M16X1.5X115 GEOMET321 PERFORATED PLUS XL	VIS TE DIN960 CI 8,8 M16X1.5X115 FORE PLUS GEOMET321 XL	TE SCHRAUBE DIN960 CI 8,8 M16X1.5X115 GEOMET321 PERFORATED PLUS XL	TE TORNILLO DIN960 CI 8,8 M16X1.5X115 GEOMET321 PERFORADA XL
17	07146500	PERNO SUPPORTO CESTO DIAM.50	PIN SUPPORT BASKET Ø50	AXE DIAM.50 PANIER DE SOUTIEN	BOLZEN KORBHALTERUNG	CLAVIJA CESTA
18	27146200	CUSCINETTO LINEARE A SFERE 50-100	LINEAR BALL BEARING 50-100	ROULEMENT Á BILLES	LINEAR-KUGELLAGER 50-100	COJINETE DE BOLAS 50-100
19	07146400	TAPPO CHIUSURA PERNI SUPPORTO CESTO DIAM.50	CAP PINS BASKET SUPPORT Ø50	BOUCHON	VERSCHLUSS	TAPÓN
20	371459A6	SLITTA FISSAGGIO CESTO PERNI DIAM.50	SLIDE BASKET MOUNTING BOLTS Ø50	GRILLE COULISSANTE MONTAGE	SLIDE RACKMONTAGE	PARRILLA CORREDIZA MONTAJE
20	371459H2	SLITTA FISSAGGIO CESTO PERNI DIAM.50	SLIDE BASKET MOUNTING BOLTS Ø50	COULISSEAU	SCHLITTEN	CORREDERA



Main color codes:  J1 - JLG Cream,  J2 - JLG Orange,  C4 - Green

 SUPPORTO CESTO

 BASKET SUPPORT

 PANIER CUPPORT
HALTERUNG ARBEITSKORB SOPORTE CESTA 





POS	Codice	 Descrizione	 Description	 Designation	 Benennung	 Descripción
21	06665000	FUNE	CABLE	CÂBLE	SEIL	CABLE
22	058600H3	PIASTRA	PLATE	PLAQUE	PLATTE	PLACA
22	07052900	STAFFA	BRACKET	ÉTRIER	HALTEBÜGEL	ESTRIBO
23	05643600	CASSETTA PORTAMANUALE	MANUAL BOX	BOÎTE PORTE- MANUEL	BEDIENUNGSANLEIT- UNGSFACH	CAJA PORTAMANUAL
24	06477600	MAGNETE Ø20 CON FORO M3	MAGNETO Ø20 WITH M3 HOLE	AIMANT	MAGNET	IMÁN
25	072398H3	PIASTRA FISSAGGIO CESTO (SOLO MACCHINE MODELLO JP E JA E X17J)	FIXING PLATE BASKET (ONLY MACHINES MODEL JP AND JA AND X17J)	PLATE FIXATION DRUM	PLATE BEFESTIGUNG DRUM	PLACA FIJACIÓN TAMBOR
26	07690700	PROTEZIONE TRASPARENTE	PROTECTION	PROTECTION	SCHUTZ	PROTECCIÓN
27	17716900	CESTO MONOPOSTO COMPLETO PER X26JP	BASKET COMPLETE SINGLE PERSON X26JP	PANIER UNE PERSONNE	EIN-MANN KORB	CESTA PARA 1 PERSONA
27	27589300	CESTO BIPOSTO 230KG PER MK2 (DA C170000893)	BASKET 2 PERSON 230KG FOR MK2 (FROM C170000893)	PANIER 2 PERSONNES POUR MK2 (FROM C170000893)	2 MANN- ARBEITSKORB FÜR MK2 (FROM C170000893)	CESTA 2 PERSONAS PARA MK2 (FROM C170000893)
27	27673500	CESTO MONOPOSTO LL2614-X26JP-X770AJ SALDATO	SINGLE BASKET LL2614-X26JP-X770AJ WELDED	PANIER 1 PERSONNE	1 MANN KORB	CESTA 1 PERSONA
27	28250000	CESTO	BASKET	PANIER POUR 2 PERSONNES	2-MANN- ARBEITSKORB	CESTA PARA DOS PERSONAS
28	06598500	FUNE	CABLE	CÂBLE	SEIL	CABLE
29	05475900	ANTIVIBRANTE	DAMPING	ANTI - VIBRANT	VIBRATIONSDÄMPFE R	ANTIVIBRANTE
30	36585800	SCALETTA	LADDER	ÉCHELLE	LEITER	ESCALERA
31	06585900	ROTELLINA	SMALL ROLLER	ROULETTE	RÄDCHEN	RUEDECILLA
32	058600H3	PIASTRA	PLATE	PLAQUE	PLATTE	PLACA
33	377661A6	MENSOLA SUPPORTO CELLA DI CARICO	BRACKET SUPPORT LOAD CELL	BRIDE SUPPORT CELLULE DE CHARGE	STEIGBÜGELHALTER UNG FÜRLASTÜBERWACH UNGSZELLE	BRIDA SOPORTE CELULA DE CARGA



Main color codes:  J1 - JLG Cream,  J2 - JLG Orange,  C4 - Green

 SUPPORTO CESTO

 BASKET SUPPORT

 PANIER CUPPORT
HALTERUNG ARBEITSKORB SOPORTE CESTA 

POS	Codice	 Descrizione	 Description	 Designation	 Benennung	 Descripción
33	377661H2	MENSOLA SUPPORTO CELLA DI CARICO	BRACKET SUPPORT LOAD CELL	BRIDE SUPPORT CELLULE DE CHARGE	STEIGBÜGELHALTER UNG FÜRLASTÜBERWACH UNGSZELLE	BRIDA SOPORTE CELULA DE CARGA
34	07766500	PERNO INCERNIERAMENTO MENSOLA SUPPORTO CESTO	PIN HINGE BRACKET SUPPORT BASKET	AXE	STIFT	PERNIO
35	07751100	RUOTE INFERIORI PER CESTO CON FRENO	LOWER WHEELS FOR BASKET WITH BRAKE	ROUES POUR PANIER	KORBRÄDER	RUEDAS
37	06418600	PROTEZIONE	PROTECTION	PROTECTION	SCHUTZ	PROTECCIÓN
38	06272700	BOCCOLA	BUSH	DOUILLE	BUCHSE	CASQUILLO
40	07687300	RUOTE INFERIORI PER CESTO	LOWER WHEEL	ROULEAU INFERIEUR	UNTERES RAD	RUEDA INFERIOR
41	27673500	CESTO MONOPOSTO LL2614-X26JP-X770AJ SALDATO	SINGLE BASKET LL2614-X26JP-X770AJ WELDED	PANIER 1 PERSONNE	1 MANN KORB	CESTA 1 PERSONA
42	17569900	PROTEZIONE TELECOMANDO	PROTECTION REMOTE CONTROL	PROTECTION	SCHUTZ	PROTECCIÓN
43	072404H3	SUPPORTO PEDALE	PEDAL SUPPORT PLATE	TÔLE PLIÉE	HALTERUNG	SOPORTE
44	07192700	CHIUSURA A VOLANTINO CON LEVA PIEGATA (SOLO MACCHINE MODELLO JP E JA E X17J)	LOCKING WHEEL WITH BENT LEVER (ONLY MACHINES MODEL JP AND JA AND X17J)	POIGNEE DE BLOCAGE	KUGELVERSCHLUSS	POMO DE BLOQUEO
45	07239700	DISTANZIALE PER VITI M8 SUPPORTO CESTO (SOLO MACCHINE MODELLO JP E JA E X17J)	SPACER SCREW M8 SUPPORT BASKET (ONLY MACHINES MODEL JP AND JA AND X17J)	ENTRETOISE	DISTANZSTÜCK	DISTANCIADOR
46	07031800	TUBO	PIPE	TUYAU	ROHR	TUBO

Main color codes:  J1 - JLG Cream,  J2 - JLG Orange,  C4 - Green

 SUPPORTO CESTO

 BASKET SUPPORT





 PANIER CUPPORT
HALTERUNG ARBEITSKORB SOPORTE CESTA 



POS	Codice	 Descrizione	 Description	 Designation	 Benennung	 Descripción
47	07193000	DADO AD INTAGLI UNI5593 CI 8 M16X1.5 GEOMET321 PLUS XL	NUT M16X1.5 NOTCHES UNI5593 CI 8 GEOMET321 PLUS XL	ÉCROU UNI5593 CI 8 M16X1.5 GEOMET321 PLUS XL	MUTTER UNI5593 CI 8 M16X1.5 GEOMET321 PLUS XL	TUERCA UNI5593 CI 8 M16X1.5 GEOMET321 PLUS XL
48	07192600	RONDELLA SPECIALE HV 300 - D 17X48X6 GEOMET321/A+PLUS XL	SPECIAL WASHER HV 300 - 17X48X6 GEOMET321 D / A + PLUS XL	RONDELLE SPECIALE HV 300 - 17X48X6 GEOMET321 D / A + PLUS XL	SCHEIBE HV 300 - 17X48X6 GEOMET321 D / A + PLUS XL	ARANDELA ESPECIAL HV 300 - 17X48X6 GEOMET321 D / A + PLUS XL
49	17768100	KIT SKY GUARD COMPLETO BIPOSTO PER CCBS	SKYGUARD COMPLETE KIT FOR 2 PERSON CCBS	KIT SKY GUARD	SKY GUARD SATZ	KIT SKY GUARD
49	17768300	KIT SKY GUARD COMPLETO MONOPOSTO PER CCBS	SKYGUARD COMPLETE KIT FOR SINGLE PERSON CCBS	KIT SKY GUARD	SATZ SKY GUARD	KIT SKY GUARD
50	08309700	DISTANZIALE	SPACER	ÉPAISSEUR	DISTANZSTÜCK	ESPACIADOR
50	37609800	TELAIO SUPPORTO SKY-GUARD CESTO BIPOSTO	SKY-FRAME SUPPORT GUARD BASKET 2PERSON	CHÂSSIS	RAHMEN	CHASIS
50	37675400	TELAIO SUPPORTO SKY-GUARD CESTO MONOPOSTO	SKY-FRAME SUPPORT GUARD BASKET 1PERSON	CHÂSSIS SUPPORT	RAHMEN HALTERUNG	BASTIDOR SOPORTE
50	38302200	SUPPORTO DESTRO	SUPPORT	SUPPORT	HALTERUNG	SOPORTE
50	38302300	SUPPORTO SINISTRO	SUPPORT	SUPPORT	HALTERUNG	SOPORTE
51	07796900	BLOCCHETTO PLASTICA PER FISSAGGIO SKYGUARD (1001188889)	BLOCK PLASTIC FOR SECURING SKYGUARD (1001188889)	BLOC	BLOCK	BLOQUE
52	07797000	COVER IN GOMMA PER PROTEZIONE FISSAGGIO SKY GUARD (1001186517)	COVER RUBBER PROTECTION FOR FIXING SKY GUARD (1001186517)	PROTECTION	SCHUTZ	PROTECCIÓN



 SUPPORTO CESTO

 BASKET SUPPORT



 PANIER CUPPORT
HALTERUNG ARBEITSKORB SOPORTE CESTA 

POS	Codice	 Descrizione	 Description	 Designation	 Benennung	 Descripción
52	08310700	COVER DESTRA SKYLINE	SKYLINE RIGHT COVER	COUVERTURE DROITE	RECHTE ABDECKUNG	COBERTURA
52	08310800	COVER SINISTRA SKYLINE	SKYLINE LEFT COVER	COUVERTURE GAUCHE	LINKE ABDECKUNG	COBERTURA IZQUIERDA
53	08132300	BACCHETTA IN FIBRA DI VETRO	GLASS FIBER WAND	BAGUETTE EN FIBRE DE VERRE	GLASFASERSTAB	VARILLA DE FIBRA DE VIDRIO
53	17796800	ASSIEME SENSORE E BARRA DI SUPPORTO PER SKYGUARD NON LAVORATO E NON VERNICIATO	SENSOR ASSEMBLY AND SUPPORT BAR FOR SKYGUARD NOT WORKED OUT AND NOT PAINTED	CAPTEURS	SENSOREN	SENSORES
53	18310600	MICRO	MICRO WITH WIRING	MICROINTERRPTEUR	MIKROSCHALTER	MICROINTERRUPTOR
53	27796800	SENSORE SKYGUARD	SENSOR SKYGUARD	CAPTEUR	SENSOR	SENSOR
54	07771500	MANIGLIA	HANDLE	POIGNÉE	GRIFF	MANIJA

 ACCOPPIAMENTO MOTORE DIESEL- POMPA
 DIESEL ENGINE COUPLING - PUMP
 ACCOUPLEMENT MOTEUR DIESEL - POMPE

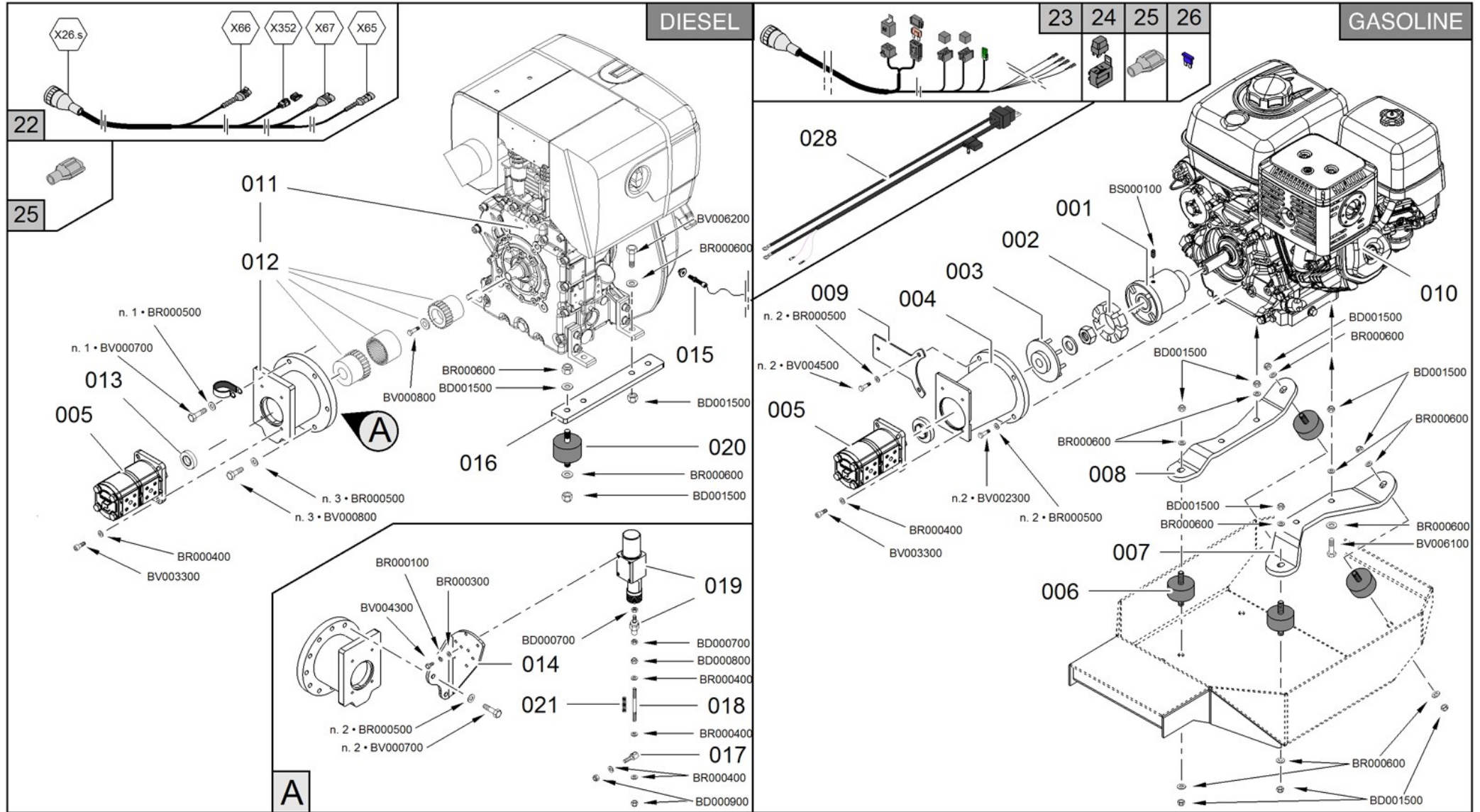
PUMPEN / DIESELMOTOR KUPPLUNG 
 ACOPLAMIENTO MOTOR DIESEL- BOMBA 









Main color codes:  J1 - JLG Cream,  J2 - JLG Orange,  C4 - Green

 ACCOPPIAMENTO MOTORE DIESEL- POMPA

 DIESEL ENGINE COUPLING - PUMP

 ACCOUPLEMENT MOTEUR DIESEL - POMPE



 PUMPEN / DIESELMOTOR KUPPLUNG 
 ACOPLAMIENTO MOTOR DIESEL- BOMBA 





POS	Codice	 Descrizione	 Description	 Designation	 Benennung	 Descripcìon
1	04310200	SEMIGIUNTO	HALF COUPLING	DEMI-JOINT	HALBVERBINDUNG	SEMI-ACOPLAMIENTO
2	04310100	INSERTO IN GOMMA	RUBBER INSERT	INSERT EN CAOUTCHOUC	GUMMIEINSATZ	INSERTO DE GOMA
3	04615300	GIUNTO	COUPLING	JOINT	VERBINDUNG	ACOPLAMIENTO
4	04310300	LANTERNA	LANTERN	LANTERNE	BUCHSE	LINTERNA
6	07804100	ANTIVIBRANTE VERSIONE BENZINA	ANTI-VIBRATING GASOLINE VERSION	ANTI - VIBRANT	VIBRATIONSDÄMPFER	ANTIVIBRANTE
7	077494Y1	PIATTO SINISTRO SUPPORTO MOTORE HONDA LL1570	LEFT PLATE SUPPORT HONDA MOTOR LL1570	PLAQUE GAUCHE SUPPORT MOTEUR	LINKE PLATTE MOTORHALTERUNG	PLACA IZQUIERDA SOPORTE MOTOR
8	077493Y1	PIATTO DESTRO SUPPORTO MOTORE HONDA LL1570	RIGHT PLATE SUPPORT HONDA MOTOR LL1570	PLAQUE DROITE SUPPORT MOTEUR	RECHTE PLATTE MOTORHALTERUNG	PLACA DERECHA SOPORTE MOTOR
9	061177H2	STAFFA	BRACKET	ÉTRIER	HALTEBÜGEL	ESTRIBO
10	27775900	MOTORE HONDA IGX390 MODIFICATO SENZA BLOCCHETTO CHIAVE DI ACCENSIONE MK2 (DA C170000893)	HONDA MOTOR IGX390 MODIFIED WITHOUT IGNITION SWITCH MK2 (FROM C170000893)	MOTEUR HONDA IGX390	HONDA MOTOR IGX390	MOTOR HONDA IGX390
11	27110400	MOTORE DIESEL HATZ 10HP VERSIONE CON PREDISPOSIZIONE REGOLAZIONI GIRI ELETTRONICA (NO CARB-EPA CERT)	HATZ DIESEL ENGINE 10HP VERSION WITH PREDISPOSITION TO ELECTRONIC SPEED REGULATION (NO CARB-EPA CERT)	MOTEUR DIESEL	DIESELMOTOR	MOTOR DIESEL

 ACCOPPIAMENTO MOTORE DIESEL- POMPA

 DIESEL ENGINE COUPLING - PUMP

 ACCOUPLEMENT MOTEUR DIESEL - POMPE



 PUMPEN / DIESELMOTOR KUPPLUNG 
 ACOPLAMIENTO MOTOR DIESEL- BOMBA 





POS	Codice	 Descrizione	 Description	 Designation	 Benennung	 Descripción
11	27676900	MOTORE DIESEL HATZ 1B40 RPM SENZA CHIAVE+ACCOPPIAMENTO (TIER3 SOLO VERS. EU, NO CARB-EPA CERT) MK2 (DA C170000893)	DIESEL ENGINE HATZ 1B40 RPM WITHOUT KEY + COUPLING (TIER3 ONLY VERS. EU, NON-EPA CARB CERT) MK2 (FROM C170000893)	MOTEUR DIESEL HATZ	HATZ DIESEL MOTOR	MOTOR DIESEL HATZ
12	2558630001	ACCOPPIAMENTO MOTORE - POMPA	ENGINE COUPLING - PUMP	ACCOUPLEMENT MOTEUR - POMPE	PUMPEN-/MOTORKUPPLUNG	ACOPLAMIENTO MOTOR - BOMBA
13	055591Y2	DISTANZIALE	SPACER	ENTRETOISE	DISTANZSTÜCK	DISTANCIADOR
14	070989H2	STAFFA	BRACKET	ÉTRIER	HALTEBÜGEL	HALTEBÜGEL
15	26514900	SENSORE	SENSOR	CAPTEUR	SENSOR	SENSOR
16	057900Y1	PIATTO	PLATE	PLATEAU	PLATTE	PLACA
17	070986Y2	PERNO	PIN	GOUJON	ZAPFEN	PERNIO
18	07098700	TIRANTE	TIE ROD	TIRANT	TURMGESTÄNGE	TIRANTE
19	26551500	PISTONE	PISTON	PISTON	KOLBEN	PISTÓN
20	07804200	ANTIVIBRANTE VERSIONE BENZINA	ANTI-VIBRATING GASOLINE VERSION	ANTI - VIBRANT	VIBRATIONSDÄMPFER	ANTIVIBRANTE
21	07098800	MOLLA	SPRING	RESSORT	FEDER	MUELLE
22	17729700	KIT ELE INTEGRAZIONE MOTORE DIESEL 10HP LL1570-X15JP-X430AJ	INTEGRATION KIT ELE DIESEL 10HP LL1570-X15JP-X430AJ	KIT ELECTRIQUE INTEGRATION	ELEKTRISCHE ERGÄNZUNGSATZ	KIT INTEGRACIÓN ELÉCTRICA
23	17729600	KIT ELE INTEGRAZIONE MOTORE BENZINA 13I LL1570	INTEGRATION KIT ELE MOTOR GASOLINE 13 THE LL1570	KIT ÉLECTRIQUE	ELEKTROSATZ	KIT ELÉCTRICO
24	1776330003	RELE' MINI TYCO 12V PER CONNETTORE A TENUTA (MK2 DA C170000893)	RELAY 'MINI 12V TYCO CONNECTOR SEAL (MK2 FROM C170000893)	RELAIS	RELAIS	RELÉ



 ACCOPPIAMENTO MOTORE DIESEL- POMPA

 DIESEL ENGINE COUPLING - PUMP

 ACCOUPLEMENT MOTEUR DIESEL - POMPE

 PUMPEN / DIESELMOTOR KUPPLUNG 
 ACOPLAMIENTO MOTOR DIESEL- BOMBA 

POS	Codice	 Descrizione	 Description	 Designation	 Benennung	 Descripción
24	1776330004	PORTA RELE' A TENUTA PER MINI TYCO 12V (MK2 DA C170000893)	HOLDER RELAY SEAL FOR MINI 12V TYCO (MK2 FROM C170000893)	PORTE RELAIS	RELAISHALTER	PORTARELÉ
24	1776330005	GOMMINO PER RELE' A TENUTA MINI TYCO 12V (MK2 DA C170000893)	RUBBER FOR RELAY SEAL MINI 12V TYCO (MK2 FROM C170000893)	JOINT RELÉ	GUMMIDICHTUNG	JUNTA DE GOMA
24	1776330007	PUNTALINI PER RELE' A TENUTA MINI TYCO 12V (MK2 DA C170000893)	FERRULE FOR RELAY SEAL MINI 12V TYCO (MK2 FROM C170000893)	BORNE	KLEMME	BORNE
25	1757250022	TAPPO CONNETTORE YAZAKI 2 VIE CON DIODO 1.5A	PLUG	BOUCHON	DECKEL	TAPA
26	1739150057	FUSIBILE A LAMA DA 30A	FUSE BLADE 30A	FUSIBLE À LAME 30A	30 A SICHERUNG	FUSIBILE A LAMA 30A
27	07819000	PARATIA PROTEZIONE CARBURATORE	PLATE PROTECTION CARB	PLAQUE PROTECTION	SCHUTZPLATTE	PLACE PROTECCIÓN
28	17965000	KIT RELE' AGGIUNTIVO SEGNALE MOTORE ACCESO HONDA IGX390	KIT RELAY 'ADDITIONAL SIGNAL ON HONDA MOTOR IGX390	KIT RELAIS	RELAIS KIT	KIT RELÉ

-  RICAMBI MOTORE
-  ENGINE SPARE PARTS
-  PIÈCES DÉTACHÉES DU MOTEUR



- MOTORERSATZTEILE 
- REPUESTOS MOTOR 

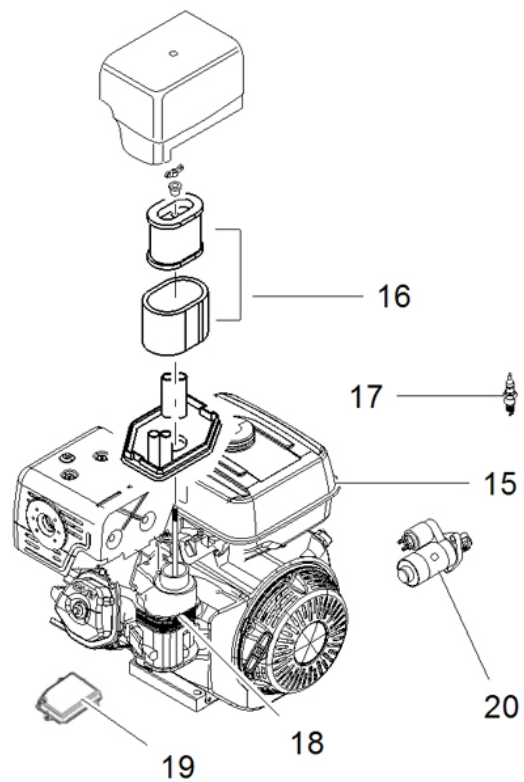

GASOLINE HONDA iGX390

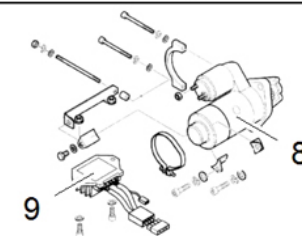
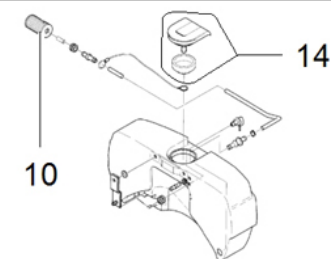
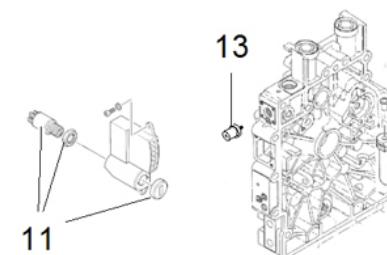
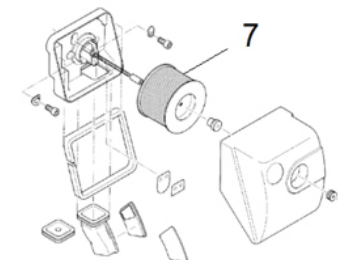



DIESEL HATZ 1B40







 RICAMBI MOTORE
 ENGINE SPARE PARTS
 PIÈCES DÉTACHÉES DU MOTEUR





MOTORERSATZTEILE 
 REPUESTOS MOTOR 



POS	Codice	 Descrizione	 Description	 Designation	 Benennung	 Descripción
7	2625560002	FILTRO ARIA	AIR FILTER	FILTER À AIR	LUFTFILTER	FILTRO AIRE
8	2631430005	MOTORINO D'AVVIAMENTO 1B40	STARTER MOTOR 1B40	MOTEUR DE DEMARREUR 1B40	STARTER MOTOR 1B40	MOTOR DE ARRANQUE 1B40
9	2558630005	REGOLATORE DI TENSIONE	VOLTAGE REGULATOR	RÉGULATEUR DE TENSION	SPANNUNGSREGLER	REGULADOR DE TENSIÓN
9	2558630009	REGOLATORE DI CORRENTE HATZ MODELLO DUCATI	CURRENT REGULATOR HATZ DUCATI MODEL	RÉGULATEUR DE TENSION MOTEUR HATZ	HYDRAULISCHER ANTRIEB	COMANDO HIDRÁULICO
10	2558630003	FILTRO NAFTA MOTORE HATZ 1B30 E 1B40 (FINO AL SERIALE 1101917068544-1B40 E 1012917108022-1B30)	DIESEL FILTER FOR HATZ 1B30 AND 1B40 (UNTIL SERIAL 1101917068544-1B40 AND 1012917108022- 1B30)	FILTRE À GASOIL	KRAFTSTOFFFILTER	FILTRO GASÓLEO
11	2631430001	BLOCCHETTO CHIAVE	BLOCK	BLOC	BLOCK	BLOQUE
13	2558630008	SOLENOIDE	SOLENOID	SOLENOÏDE	SOLENOID	SOLENOIDE
14	2631430004	TAPPO SERBATOIO GASOLIO	FUEL TANK CAP	BOUCHON RÉSERVOIR GASOIL HATZ 1B30-1B40	TANKDECKEL	TAPA DEPÓSITO GASOIL
15	2775200002	SERBATOIO BENZINA COMPLETO HONDA IGX390	FUEL TANK COMPLETE HONDA IGX390	RÉSERVOIR ESSENCE	BENZINTANK	DEPÓSITO DE GASOLINA
16	2775200001	CARTUCCIA FILTRO ARIA COMPLETA HONDA IGX390	AIR FILTER CARTRIDGE COMPLETE HONDA IGX390	FILTRE À AIR	LUFTFILTER	FILTRO DE AIRE
17	2558640003	CANDELA ACCENSIONE	SPARKING PLUG	BOUGIE ÉLECTRIQUE	ZÜNDKERZE	BUJÍA ENCENDIDO
18	2775200003	CARBURATORE COMPLETO HONDA IGX390 EURO 2(VALIDO FINO A SN MOTORE 3000001)	CARBURETOR COMPLETE HONDA IGX390 EURO 2 (VALID UNTIL ENGINE SN 3000001)	CARBURATEUR COMPLET HONDA IGX390 EURO 2 (VALABLE JUSQU'AU MOTEUR SN 3000001)	VERGASER KOMPLETT HONDA IGX390 EURO 2 (GÜLTIG BIS MOTOR SN 3000001)	CARBURADOR COMPLETO HONDA IGX390 EURO 2 (VÁLIDO HASTA MOTOR SN 3000001)



Main color codes:  J1 - JLG Cream,  J2 - JLG Orange,  C4 - Green

 RICAMBI MOTORE
 ENGINE SPARE PARTS
 PIÈCES DÉTACHÉES DU MOTEUR



MOTORERSATZTEILE 
 REPUESTOS MOTOR 

POS	Codice	 Descrizione	 Description	 Designation	 Benennung	 Descripción
18	2775200006	CARBURATORE COMPLETO HONDA IGX390 STAGE V (VALIDO DA SN MOTORE 3000001)	CARBURETOR COMPLETE HONDA IGX390 STAGE V (VALID FROM ENGINE SN 3000001)	CARBURATEUR COMPLET HONDA IGX390 STAGE V (VALABLE A PARTIR DU NUMERO DE SERIE 3000001)	VERGASER KMPL. HONDA IGX390 STAGEV (GÜLTIG AB SERIENNR. 3000001)	CARBURADOR COMPLETO HONDA IGX390 STAGE V (VÁLIDO A PARTIR DEL NÚMERO DE SERIE 3000001)
19	2775200004	CENTRALINA ELETTRONICA HONDA IGX390	ELECTRONIC CONTROL UNIT HONDA IGX390	UNITÉ ÉLECTRONIQUE	ELEKTRONISCHE EINHEIT	UNIDAD ELECTRÓNICA
20	2775200005	MOTORINO DI AVVIAMENTO COMPLETO HONDA IGX390	ELECTRIC STARTER COMPLETE HONDA IGX390	MOTEUR DE DÉMARRAGE	MOTORSTART	MOTOR DE ARRANQUE

 MOTORE ELETTRICO
 ELECTRIC MOTOR
 MOTEUR ÉLECTRIQUE

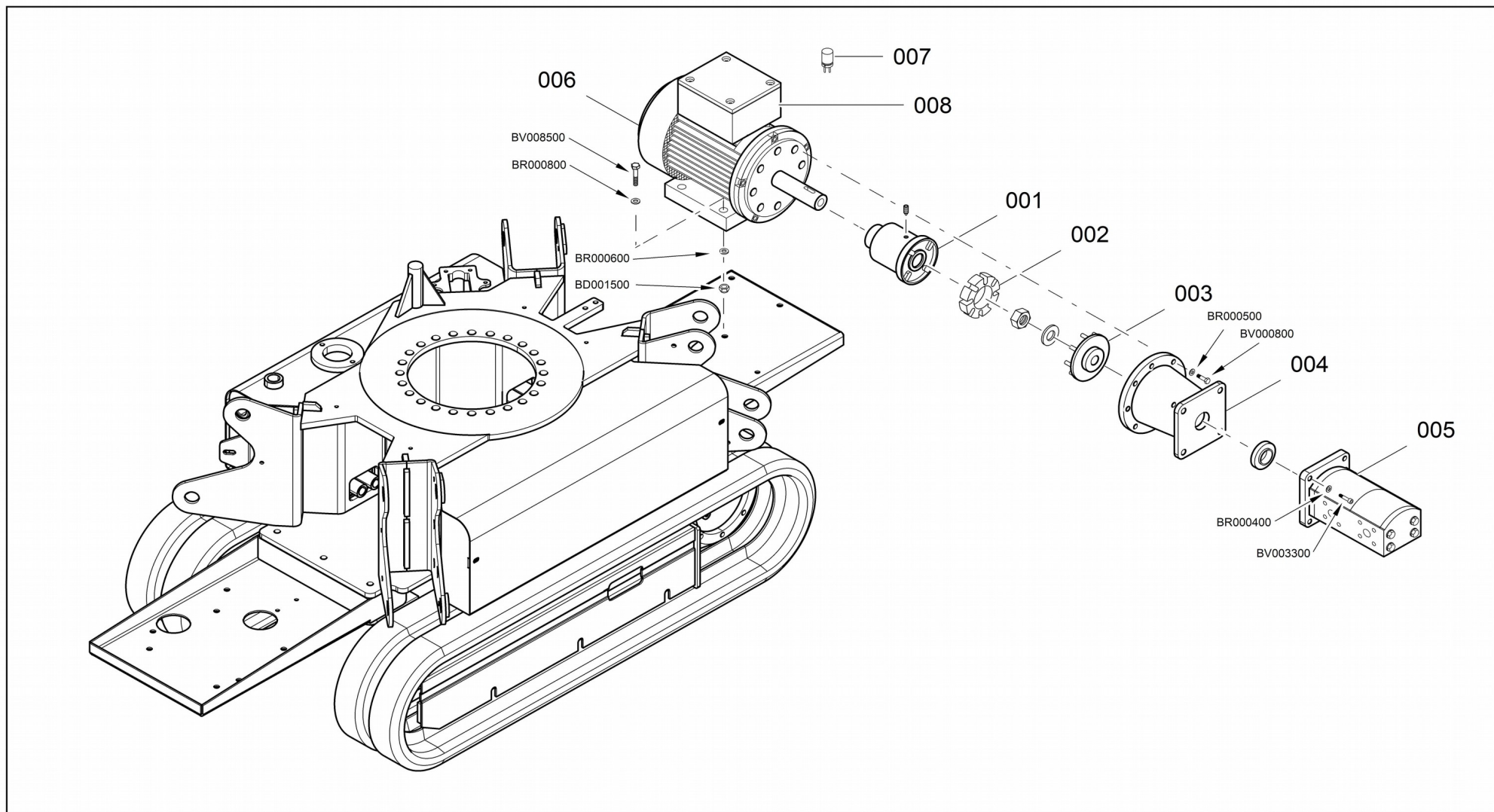
E-MOTOR 
MOTOR ELÉCTRICO 









Main color codes:  **J1** - JLG Cream,  **J2** - JLG Orange,  **C4** - Green



 MOTORE ELETTRICO

 ELECTRIC MOTOR





 MOTEUR ÉLECTRIQUE

 E-MOTOR 
 MOTOR ELÉCTRICO 

POS	Codice	 Descrizione	 Description	 Designation	 Benennung	 Descripción
1	05563400	SEMIGIUNTO VERSIONE MOTORE ELETTRICO STANDARD	HALF COUPLING ELECTRIC MOTOR STANDARD VERSION	DEMI-JOINT	HALBKUPPLUNG	SEMI-ACOPLAMIENTO
1	06997800	SEMIGIUNTO VERSIONE LITIO	HALF COUPLING LITHIUM VERSION	DEMI-JOINT	HALBKUPPLUNG	SEMI-ACOPLAMIENTO
2	04310100	INSERTO IN GOMMA	RUBBER INSERT	INSERT EN CAOUTCHOUC	GUMMIEINSATZ	INSERTO DE GOMA
3	04615300	GIUNTO	COUPLING	JOINT	VERBINDUNG	ACOPLAMIENTO
4	05510200	LANTERNA	LANTERN	LANTERNE	LATERNE	LINTERNA
5	255263H3	POMPA IDRAULICA	HYDRAULIC PUMP	POMPE HYDRAULIQUE	HYDRAULIKPUMPE	BOMBA HYDRÁULICA
5	263281H3	POMPA IDRAULICA	HYDRAULIC PUMP	POMPE HYDRAULIQUE	HYDRAULIKPUMPE	BOMBA HYDRÁULICA
6	25576400	MOTORE ELETTRICO 110V	ELECTRIC MOTOR 110V	MOTEUR ÉLECTRIQUE 110V	E-MOTOR 110V	MOTOR ELÉCTRICO 110V
6	26328300	MOTORE ELETTRICO 120V 60HZ 1.2KW 16A	ELECTRIC MOTOR 120V 60HZ 1.2KW 16A	MOTEUR ÉLECTRIQUE	E-MOTOR	MOTOR ELÉCTRICO
6	26774500	MOTORE ELETTRICO LITHIUM 2KW	ELECTRIC MOTOR LITHIUM 2KW	MOTEUR ÉLECTRIQUE	E-MOTOR	MOTOR ELÉCTRICO
6	27691100	MOTORE ELETTRICO 230V 50HZ MK2 (DA C170000893)	ELECTRIC MOTOR 230V 50HZ MK2 (FROM C170000893)	MOTEUR ÉLECTRIQUE 230V 50HZ MK2 (FROM C170000893)	E-MOTOR 230V 50HZ MK2 (FROM C170000893)	MOTOR ELÉCTRICO 230V 50HZ MK2 (FROM C170000893)
7	2557640001	CONDENSATORE 110V MF200 D=65	CAPACITOR 110V MF200 D=65	CONDENSATEUR	CAPACITOR	CAPACITOR
7	2557640002	CONDENSATORE 110V MF500	CAPACITOR 110V MF500	CONDENSATEUR	CAPACITOR	CAPACITOR
7	2632830001	CONDENSATORE PER MOTORE 120V MF120 D=55	CAPACITOR MOTOR 120V MF120 D = 55	CONDENSATEUR	KONDENSATOR	CONDENSADOR
7	2632830002	CONDENSATORE PER MOTORE 120V MF160 D=60	CAPACITOR MOTOR 120V MF160 D = 60	CONDENSATEUR	KONDENSATOR	CONDENSADOR

 Main color codes:  J1 - JLG Cream,  J2 - JLG Orange,  C4 - Green



 MOTORE ELETTRICO ELECTRIC MOTOR MOTEUR ÉLECTRIQUEE-MOTOR MOTOR ELÉCTRICO 

POS	Codice	 Descrizione	 Description	 Designation	 Benennung	 Descripción
7	2769110001	CONDENSATORE 230V MF80 D=60 CL.B	CAPACITOR 230V MF80 D=60 CL.B	CONDENSATEUR D=60 CL.B	KONDENSATOR D=60 CL.B	CONDENSADOR D=60 CL.B
8	2769110002	SCATOLA CONDENSATORE CON GUARNIZIONE	CONDENSER BOX WITH GASKET	BOÎTE DE CONDENSEUR	KONDENSATORKAST EN	CAJA CONDENSADOR



 IMPIANTO IDRAULICO MANDATE E SCARICO

 SUPPLY AND DISCHARGE HYDRAULIC SYSTEM

 SYSTÈME HYDRAULIQUE REFOULEMENT ET DÉCHARGEME

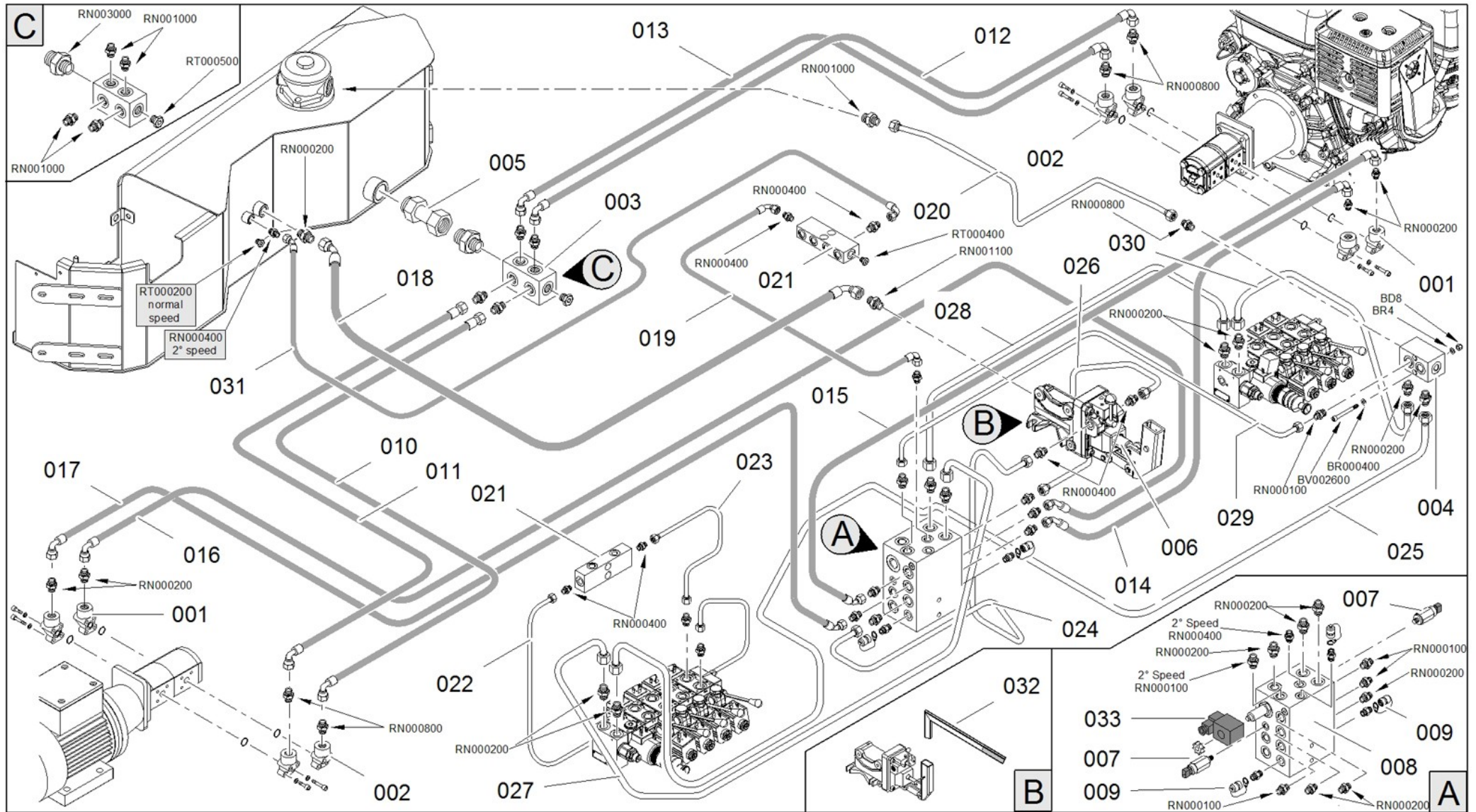
HYDRAULIKANLAGE VORLÄUFE UND RÜCKLAUF 
 INSTALACIÓN HIDRÁULICA IMPULSIONES Y DESCARGA 









Main color codes:  J1 - JLG Cream,  J2 - JLG Orange,  C4 - Green



 IMPIANTO IDRAULICO MANDATE E SCARICO

 SUPPLY AND DISCHARGE HYDRAULIC SYSTEM

 SYSTÈME HYDRAULIQUE REFOULEMENT ET DÉCHARGEME

 HYDRAULIKANLAGE VORLÄUFE UND RÜCKLAUF 
 INSTALACIÓN HIDRÁULICA IMPULSIONES Y DESCARGA 



POS	Codice	 Descrizione	 Description	 Designation	 Benennung	 Descripción
1	04048100	FLANGIA 3/8" G	FLANGE 3/8" G	BRIDE 3/8" G	FLANSCH 3/8" G	BRIDA 3/8" G
2	04845400	FLANGIA 1/2"G	FLANGE 1/2"G	BRIDE 1/2"G	FLANSCH 1/2"G	BRIDA 1/2"G
3	07764900	COLLETTORE ASPIRAZIONI POMPE LL1570	INTAKE MANIFOLD PUMPS LL1570	COLLECTEUR	KOLLEKTOR	COLECTOR
4	05497500	BLOCCHETTO TUBI	HOSES BLOCK	BLOC TUYAUX	ROHRBLOCK	BLOQUE TUBOS
5	07770500	RACCORDO PROLUNGA M-F ¼ H=20	FITTING	RACCORD	ANSCHLUSS	CONEXIÓN
6	26459400	POMPA A MANO	HAND PUMP	POMPE MANUELLE	HANDPUMPE	BOMBA DE MANO
7	26964400	PRESSOSTATO	PRESSURE SWITCH	PRESSOSTAT	DRUCKSCHALTER	PRESÓSTATO
8	17772200	VALVOLA IDRAULICA	HYDRAULIC VALVE	VALVE HYDRAULIQUE	HYDRAULIKVENTIL	VÁLVULA HIDRÁULICA
8	17805400	VALVOLA IDRAULICA	HYDRAULIC VALVE	VALVE HYDRAULIQUE	HYDRAULIKVENTIL	VÁLVULA HIDRÁULICA
9	03014400	PROVA PRESSIONE 1/4" G	PRESSURE TEST 1/4" G	PREUVE PRESSION 1/4" G	DRUCKKONTROLLE 1/4" G	PRUEBA PRESIÓN 1/4" G
10	07781100	TUBO FLESSIBILE	FLEXIBLE PIPE	TUYAU FLEXIBLE	SCHLAUCH	TUBO FLEXIBLE
11	07781200	TUBO FLESSIBILE	FLEXIBLE PIPE	TUYAU FLEXIBLE	SCHLAUCH	TUBO FLEXIBLE
12	07780900	TUBO FLESSIBILE	FLEXIBLE PIPE	TUYAU FLEXIBLE	SCHLAUCH	TUBO FLEXIBLE
13	07781000	TUBO FLESSIBILE	FLEXIBLE PIPE	TUYAU FLEXIBLE	SCHLAUCH	TUBO FLEXIBLE
14	07813300	TUBO FLESSIBILE	FLEXIBLE PIPE	TUYAU FLEXIBLE	SCHLAUCH	TUBO FLEXIBLE
15	07813600	TUBO FLESSIBILE	FLEXIBLE PIPE	TUYAU FLEXIBLE	SCHLAUCH	TUBO FLEXIBLE
16	07813400	TUBO FLESSIBILE	FLEXIBLE PIPE	TUYAU FLEXIBLE	SCHLAUCH	TUBO FLEXIBLE
17	07813500	TUBO FLESSIBILE	FLEXIBLE PIPE	TUYAU FLEXIBLE	SCHLAUCH	TUBO FLEXIBLE
18	07784000	TUBO FLESSIBILE	FLEXIBLE PIPE	TUYAU FLEXIBLE	SCHLAUCH	TUBO FLEXIBLE
19	07813700	TUBO FLESSIBILE	FLEXIBLE PIPE	TUYAU FLEXIBLE	SCHLAUCH	TUBO FLEXIBLE
20	07773000	TUBO RIGIDO	RIGID PIPE	TUYAU	SCHLAUCH	TUBO
21	04707700	COLLETTORE	MANIFOLD	COLLECTEUR	KOLLEKTOR	COLECTOR
22	07747400	TUBO RIGIDO	RIGID PIPE	TUYAU	ROHR	TUBO
23	07747300	TUBO RIGIDO	RIGID PIPE	TUYAU	ROHR	TUBO
24	07772700	TUBO RIGIDO	RIGID PIPE	TUYAU	SCHLAUCH	TUBO
25	07772300	TUBO RIGIDO	RIGID PIPE	TUYAU	SCHLAUCH	TUBO





 Main color codes:  J1 - JLG Cream,  J2 - JLG Orange,  C4 - Green



 IMPIANTO IDRAULICO MANDATE E SCARICO



 SUPPLY AND DISCHARGE HYDRAULIC SYSTEM

 SYSTÈME HYDRAULIQUE REFOULEMENT ET DÉCHARGEME



 HYDRAULIKANLAGE VORLÄUFE UND RÜCKLAUF 
 INSTALACIÓN HIDRÁULICA IMPULSIONES Y DESCARGA 

POS	Codice	 Descrizione	 Description	 Designation	 Benennung	 Descripción
26	07772800	TUBO RIGIDO	RIGID PIPE	TUYAU	SCHLAUCH	TUBO
27	07772500	TUBO RIGIDO	RIGID PIPE	TUYAU	SCHLAUCH	TUBO
28	07772600	TUBO RIGIDO	RIGID PIPE	TUYAU	SCHLAUCH	TUBO
29	07772900	TUBO RIGIDO	RIGID PIPE	TUYAU	SCHLAUCH	TUBO
30	07772400	TUBO RIGIDO	RIGID PIPE	TUYAU	SCHLAUCH	TUBO
31	07783000	TUBO FLESSIBILE	FLEXIBLE PIPE	TUYAU FLEXIBLE	SCHLAUCH	TUBO FLEXIBLE
32	16517700	LEVA	LEVER	LEVIER	HEBEL	PALANCA
33	07845200	BOBINA PER DISTRIBUTORE IDRAULICO SENZA DIODO CONNETTORE DEUTSCH	COIL FOR HYDRAULIC DISTRIBUTOR WITHOUT DIODE, CONNECTOR DEUTSCH	BOBINE	SPULE	BOBINA

 IMPIANTO IDRAULICO MANDATE E SCARICO
 SUPPLY AND DISCHARGE HYDRAULIC SYSTEM
 SYSTÈME HYDRAULIQUE REFOULEMENT ET DÉCHARGEMENT

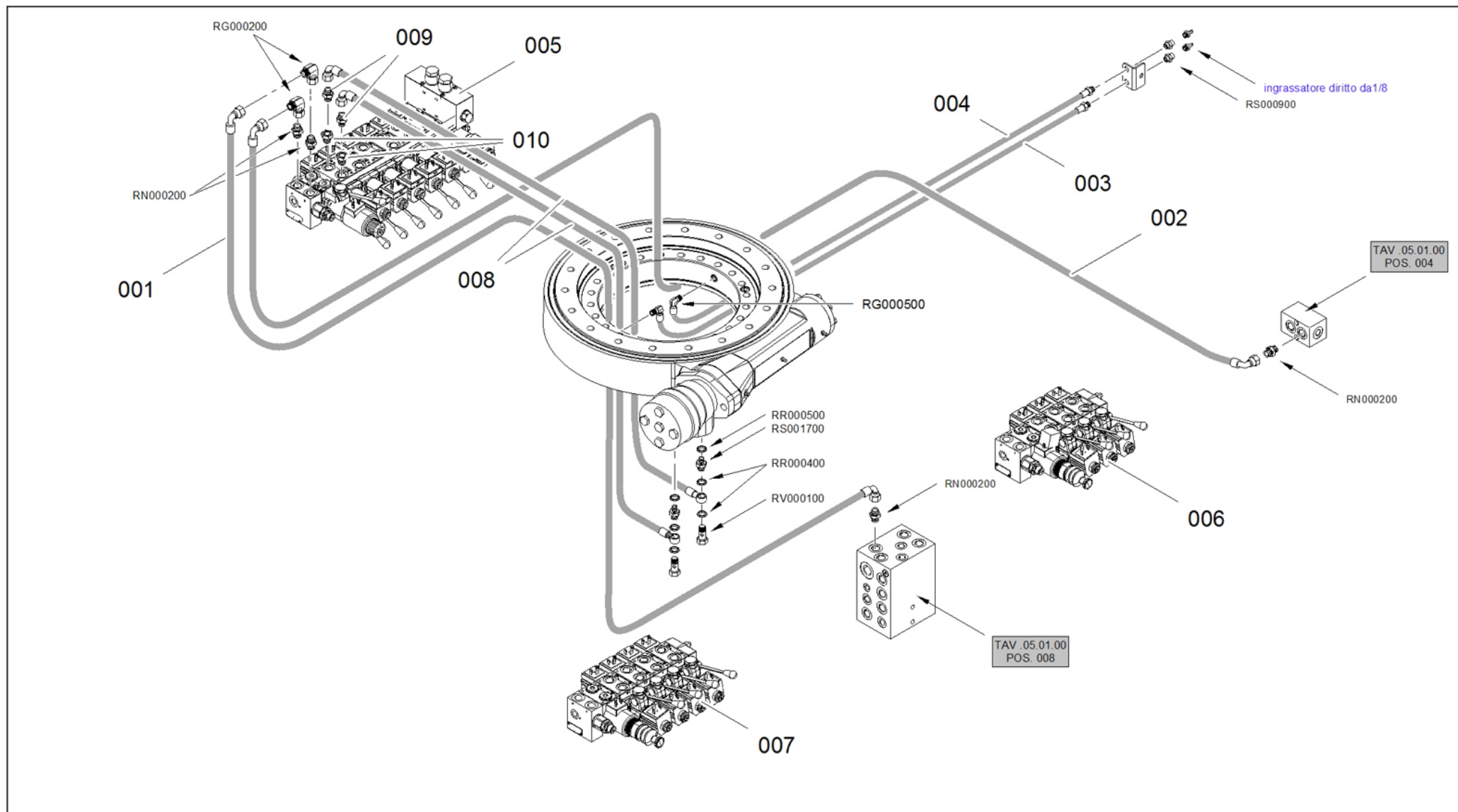
HYDRAULIKANLAGE VORLÄUFE UND RÜCKLAUF 
 INSTALACIÓN HIDRÁULICA IMPULSIONES Y DESCARGA 









Main color codes:  **J1** - JLG Cream,  **J2** - JLG Orange,  **C4** - Green



 IMPIANTO IDRAULICO MANDATE E SCARICO



 SUPPLY AND DISCHARGE HYDRAULIC SYSTEM

 SYSTÈME HYDRAULIQUE REFOULEMENT ET DÉCHARGEMENT



 HYDRAULIKANLAGE VORLÄUFE UND RÜCKLAUF 
 INSTALACIÓN HIDRÁULICA IMPULSIONES Y DESCARGA 



POS	Codice	 Descrizione	 Description	 Designation	 Benennung	 Descripción
1	07813900	TUBO FLESSIBILE	FLEXIBLE PIPE	TUYAU FLEXIBLE	SCHLAUCH	TUBO FLEXIBLE
2	07813800	TUBO FLESSIBILE	FLEXIBLE PIPE	TUYAU FLEXIBLE	SCHLAUCH	TUBO FLEXIBLE
3	07784100	TUBO FLESSIBILE	FLEXIBLE PIPE	TUYAU FLEXIBLE	SCHLAUCH	TUBO FLEXIBLE
4	07784200	TUBO FLESSIBILE	FLEXIBLE PIPE	TUYAU FLEXIBLE	SCHLAUCH	TUBO FLEXIBLE
5	27533400	DISTRIBUTORE IDRAULICO 7 ELEMENTI PARTE AEREA CON PULSANTE (FOR LL1775-X17JP-X500AJ-LL2010-X20JP-X600AJ MK2 FROM C170000893)	HYDRAULIC DISTRIBUTOR 7 ELEMENTS AERIAL PART WITH BUTTON (FOR LL1775-X17JP-X500AJ-LL2010-X20JP-X600AJ MK2 FROM C170000893)	DISTRIBUTEUR HYDRAULIQUE (FOR LL1775-X17JP-X500AJ-LL2010-X20JP-X600AJ MK2 FROM C170000893)	HYDRAULISCHER VERTEILER (FOR LL1775-X17JP-X500AJ-LL2010-X20JP-X600AJ MK2 FROM C170000893)	DISTRIBUIDOR HIDRÁULICO (FOR LL1775-X17JP-X500AJ-LL2010-X20JP-X600AJ MK2 FROM C170000893)
6	27299000	DISTRIBUTORE LC STABILIZZATORI-TRAIANO 3 ELEMENTI CON LEVE EMERGENZA A PULSANTE	HYDRAULIC DISTRIBUTOR STABILIZERS-TRACKS 3 PARTS WITH LEVERS EMERGENCY BUTTON	DISTRIBUTEUR HYDRAULIQUE	HYDR. REGELSTEUERGERÄT	DISTRIBUIDOR HIDRÁULICO
7	27299100	DISTRIBUTORE LC STABILIZZATORI-TRAIANO 4 ELEMENTI CON LEVE EMERGENZA A PULSANTE	HYDRAULIC DISTRIBUTOR STABILIZERS-TRACKS 4 PARTS WITH LEVERS EMERGENCY BUTTON	DISTRIBUTEUR HYDRAULIQUE	HYDRAULIKVENTILB LOCK	DISTRIBUIDOR HIDRÁULICO
8	07784500	TUBO FLESSIBILE	FLEXIBLE PIPE	TUYAU FLEXIBLE	SCHLAUCH	TUBO FLEXIBLE
9	06786700	RACCORDO	FITTING	RACCORD	ANSCHLUSS	CONEXIÓN
10	RS000700	RIDUZIONE M-F GAS 1" * 1/2"	REDUCING GAS M-F 1" * 1/2"	RÉDUCTION M-F GAS 1" * 1/2"	REDUZIERUNG GAS M-F 1" * 1/2"	REDUCCIÓN M-F GAS 1" * 1/2"

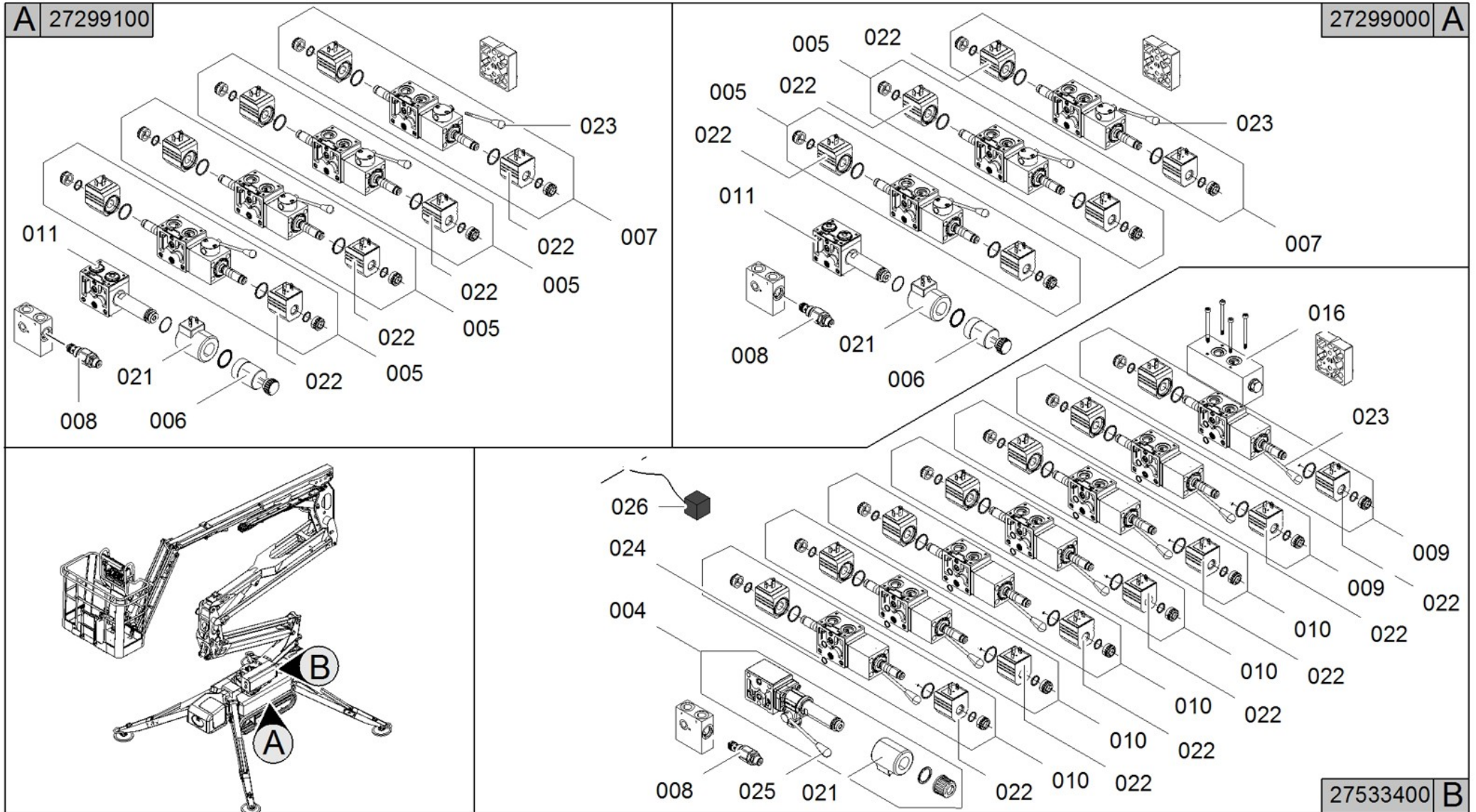

 DISTRIBITORI IDRAULICI
 HYDRAULIC DISTRIBUTORS
 DISTRIBUTEURS HYDRAULIQUES





HYDRAULISCHE REGELSTEUERGERÄTE 
 DISTRIBUIDORES HIDRÁULICOS 









Main color codes:  J1 - JLG Cream,  J2 - JLG Orange,  C4 - Green



 DISTRIBUTORI IDRAULICI
 HYDRAULIC DISTRIBUTORS
 DISTRIBUTEURS HYDRAULIQUES





HYDRAULISCHE REGELSTEUERGERÄTE 
DISTRIBUIDORES HIDRÁULICOS 



POS	Codice	 Descrizione	 Description	 Designation	 Benennung	 Descripción
4	2753340004	ELEMENTO DISTRIBUTORE COMPLETO DI PROPORZIONALE PARTE AEREA CON LEVA ROSSA (LATO 1)	VALVE BLOCK ELEMENT	ELEMENT DISTRIBUTEUR	VENTILBLOCKSATZ	ELEMENTO DISTRIBUIDOR
5	2645900005	SEZIONE DISTRIBUTORE AB CHIUSO CON LEVA (LATO A) E BOBINA	VALVE BLOCK SECTION AB CLOSED WITH LEVER (SIDE A) AND COIL	SECTION DISTRIBUTEUR	VENTILBLOCKSEKTIO N	SECCIÓN DISTRIBUIDOR
6	07324900	COMANDO MANUALE EMERGENZA CON RITORNO A MOLLA	EMERGENCY MAUAL CONTROL WITH SPRING RETURN	COMMANDE MANUEL D'URGENCE	MANUELLES ANTRIEB FÜR NOTSTAND	MANDO MANUAL DE EMERGENCIA
7	2645900006	SEZIONE DISTRIBUTORE ABT CON LEVA (LATO A) E BOBINA	VALVE BLOCK SECTION ABT WITH LEVER (SIDE A) AND COIL	SECTION DISTRIBUTEUR	VENTILBLOCKSEKTIO N	SECCIÓN DISTRIBUIDOR
8	2645900002	CARTUCCIA VALVOLA DI MASSIMA PRESSIONE	CARTRIDGE PRESSURE RELIEF VALVE	CARTOUCHE SOUPAPE DE SÉCURITÉ	PARTONE ÜBERDRUCKVENTIL	CATUCHO VÁLVULA LIMITADORA DE PRESIÓN
9	2753340002	SEZIONE DISTRIBUTORE ABT CON LEVA (LATO 1) E BOBINA	SECTION DISTRIBUTOR ABT WITH LEVER (SIDE 1) AND COIL	SECTION DISTRIBUTEUR	VENTILBLOCKSEKTIO N	SECCIÓN DISTRIBUIDOR
10	2753340001	SEZIONE DISTRIBUTORE AB CHIUSO CON LEVA (LATO 1) E BOBINA	SECTION DISTRIBUTOR AB CLOSED WITH LEVER (SIDE 1) AND COIL	SECTION DISTRIBUTEUR	VENTILBLOCKSEKTIO N	SECCIÓN DISTRIBUIDOR
11	2729900001	VALVOLA PROPORZIONALE TRAINI CON BOBINA E SENZA COMANDO MANUALE A MOLLA	PROPORTIONAL VALVE FOR TRACK WITH COIL AND WITHOUT MANUAL SPRING	SOUPAPE PROPORTIONELLE	PROPORTIONALVENT IL	VÁLVULA PROPORCIONAL

Main color codes:  J1 - JLG Cream,  J2 - JLG Orange,  C4 - Green

 DISTRIBUTORI IDRAULICI
 HYDRAULIC DISTRIBUTORS
 DISTRIBUTEURS HYDRAULIQUES

HYDRAULISCHE REGELSTEUERGERÄTE 
DISTRIBUIDORES HIDRÁULICOS 

POS	Codice	 Descrizione	 Description	 Designation	 Benennung	 Descripción
16	2585560004	BLOCCO VALVOLA BILANCIAMENTO BRACCI SU DISTRIBUTORI PARTE AEREA	BALANCING VALVE BLOCK BOOMS OF DISTRIBUTORS AERIAL PART	BLOC SOUPAPE	VENTILSPERRE	BLOQUE VÁLVULA
21	06037100	BOBINA PER VALVOLA PROPORZIONALE PARTE CARRO	COIL PROPORTIONAL VALVE FOR UNDERCARRIAGE	BOBINE	SPULE	BOBINA
22	05913800	BOBINA PER ON-OFF	COIL FOR ON-OFF	BOBINE	SPULE	BOBINA
23	07300200	LEVA DISTRIBUTORE	LEVER HYDRAULIC DISTRIBUTOR	LEVIER	HEBEL	PALANCA
24	2585560005	O-RING	O-RING	O-RING	O-RING	O-RING
25	2753340003	LEVA ROSSA DISTRIBUTORE	RED LEVER HYDRAULIC DISTRIBUTOR	LEVIER	HEBEL	PALANCA
26	1730720001	ELETTROVALVOLA ON-OFF CON LED	SOLENOID ON-OFF WITH LED	ELECTROVANNE ON- OFF AVEC LED	SOLENOID ON-OFF WITH LED	SOLENOIDE ON-OFF CON LED

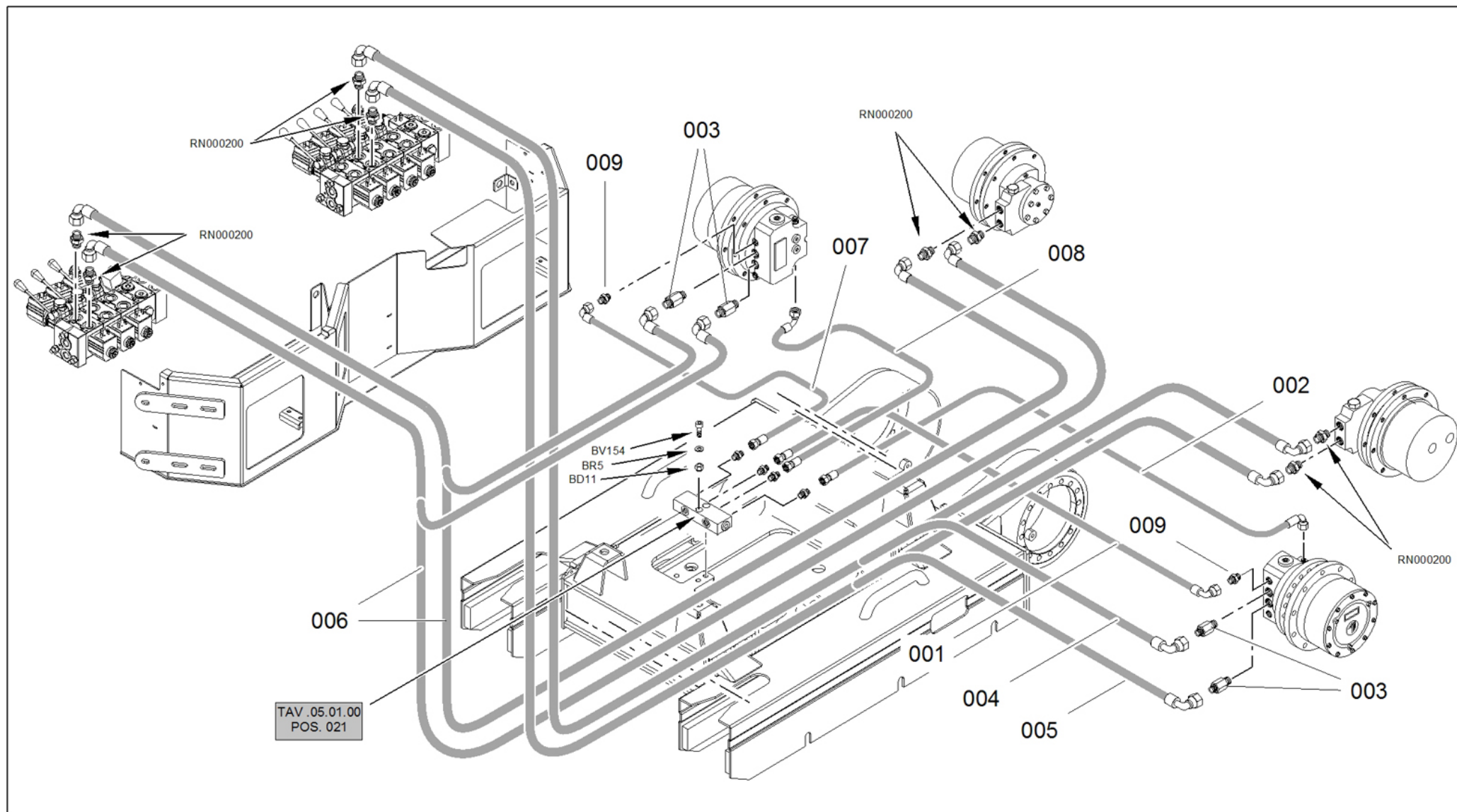

Main color codes:  J1 - JLG Cream,  J2 - JLG Orange,  C4 - Green











 IMPIANTO IDRAULICO TRAZIONE

 HYDRAULIC SYSTEM FOR TRACTION



 SYSTÈME HYDRAULIQUE DE TRACTION



 HYDRAULIKANLAGE ANTRIEB 
 INSTALACIÓN HIDRÁULICA TRACCIÓN 

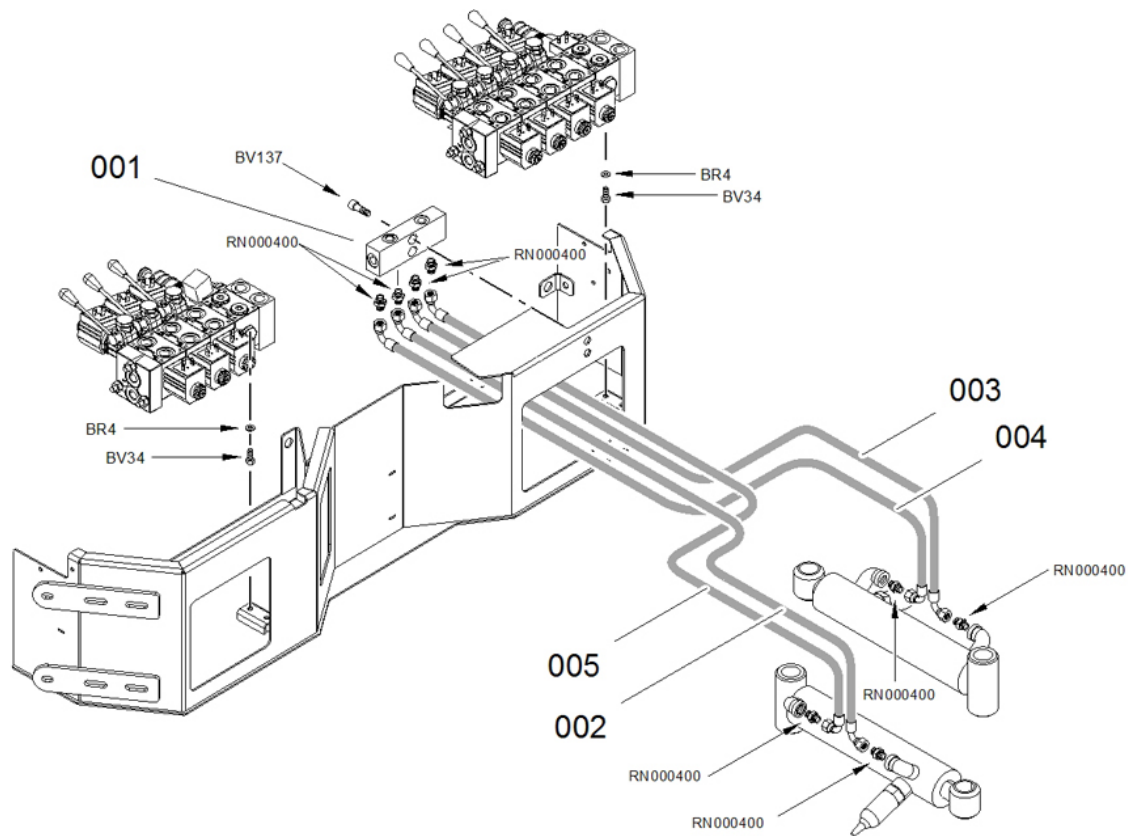



POS	Codice	 Descrizione	 Description	 Designation	 Benennung	 Descripción
1	07782600	TUBO FLESSIBILE	FLEXIBLE PIPE	TUYAU FLEXIBLE	SCHLAUCH	TUBO FLEXIBLE
2	07782500	TUBO FLESSIBILE	FLEXIBLE PIPE	TUYAU FLEXIBLE	SCHLAUCH	TUBO FLEXIBLE
3	05093900	RACCORDO 12L-3/8 JIS ESAGONO 22 H40	12L-FITTING 3/8 JIS HEX22 H40	RACCORD	ANSCHLUSS	CONEXIÓN
4	07783700	TUBO FLESSIBILE	FLEXIBLE PIPE	TUYAU FLEXIBLE	SCHLAUCH	TUBO FLEXIBLE
5	07783800	TUBO FLESSIBILE	FLEXIBLE PIPE	TUYAU FLEXIBLE	SCHLAUCH	TUBO FLEXIBLE
6	07783900	TUBO FLESSIBILE	FLEXIBLE PIPE	TUYAU FLEXIBLE	SCHLAUCH	TUBO FLEXIBLE
7	07782800	TUBO FLESSIBILE	FLEXIBLE PIPE	TUYAU FLEXIBLE	SCHLAUCH	TUBO FLEXIBLE
8	07782700	TUBO FLESSIBILE	FLEXIBLE PIPE	TUYAU FLEXIBLE	SCHLAUCH	TUBO FLEXIBLE
9	05582000	RACCORDO	FITTING	RACCORD	ANSCHLUSS	CONEXIÓN



 Main color codes:  J1 - JLG Cream,  J2 - JLG Orange,  C4 - Green





 IMPIANTO IDRAULICO ALLARGAMENTO CARRO
 HYDRAULIC SYSTEM UNDERCARRIAGE EXPANSION
 SYSTÈME HYDRAULIQUE EXTENSION DU CHARIOT



HYDRAULIKANLAGE VERBREITERUNG WAGEN 
 INSTALACIÓN HIDRAULICA ENSANCHAMIENTO CARRO 

POS	Codice	 Descrizione	 Description	 Designation	 Benennung	 Descripción
1	04707700	COLLETTORE	MANIFOLD	COLLECTEUR	KOLLEKTOR	COLECTOR
2	07783500	TUBO FLESSIBILE	FLEXIBLE PIPE	TUYAU FLEXIBLE	SCHLAUCH	TUBO FLEXIBLE
3	07783600	TUBO FLESSIBILE	FLEXIBLE PIPE	TUYAU FLEXIBLE	SCHLAUCH	TUBO FLEXIBLE
4	07783300	TUBO FLESSIBILE	FLEXIBLE PIPE	TUYAU FLEXIBLE	SCHLAUCH	TUBO FLEXIBLE
5	07783400	TUBO FLESSIBILE	FLEXIBLE PIPE	TUYAU FLEXIBLE	SCHLAUCH	TUBO FLEXIBLE

-  IMPIANTO IDRAULICO STABILIZZATORI
-  STABILIZERS HYDRAULIC SYSTEM
-  INSTALLATION HYDRAULIQUE STABILISATERS

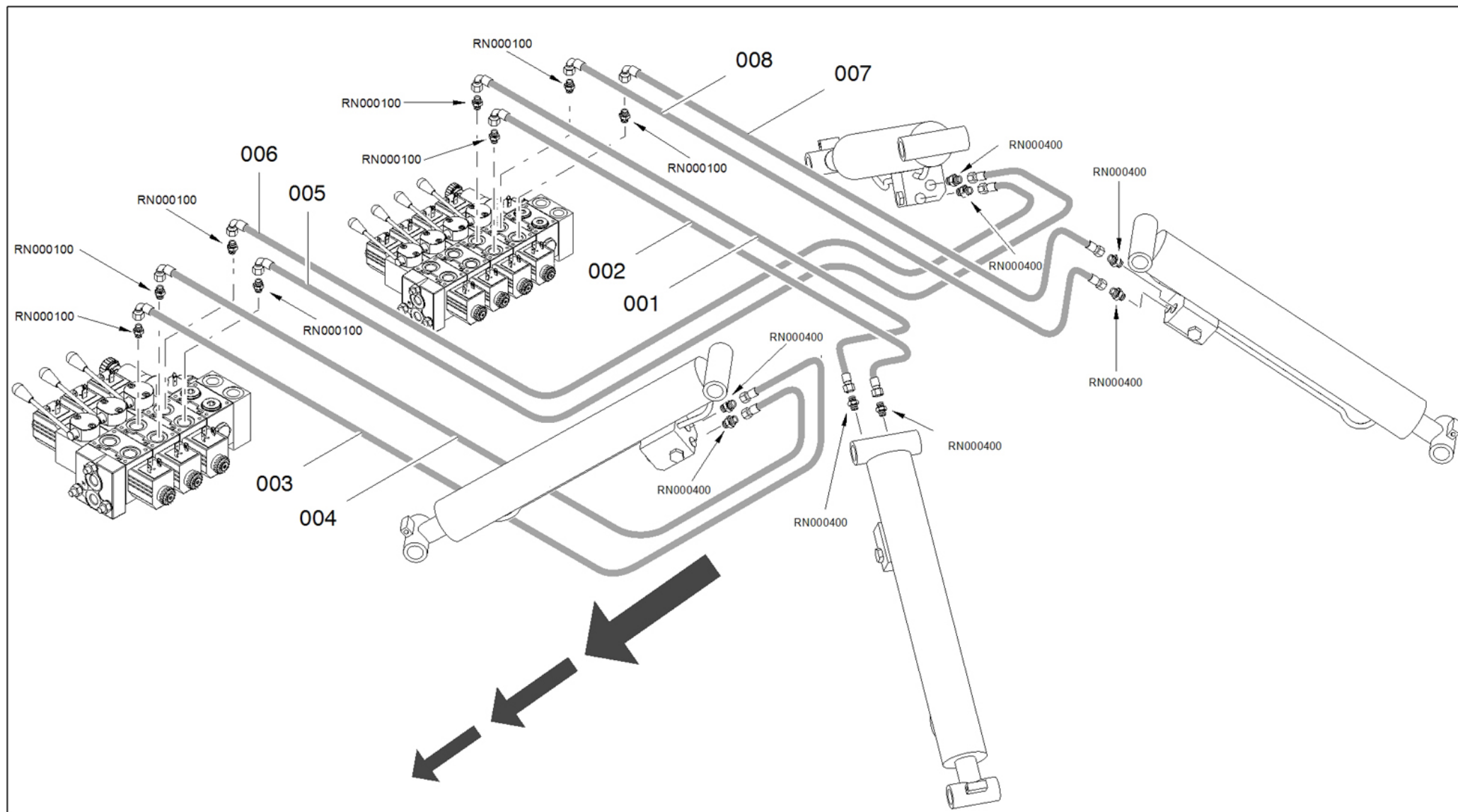
ABSTÜTZUNG ABSTÜTZUNGSHYDRAULIKZYLINDR 
INSTALACIÓN HIDRAULICA ESTABILIZADORS 



Main color codes:  J1 - JLG Cream,  J2 - JLG Orange,  C4 - Green





 IMPIANTO IDRAULICO STABILIZZATORI



 STABILIZERS HYDRAULIC SYSTEM

 INSTALLATION HYDRAULIQUE STABILISATERS

 ABSTÜTZUNG ABSTÜTZUNGSHYDRAULIKZYLIND

 INSTALACIÓN HIDRAULICA ESTABILIZADORS





POS	Codice	 Descrizione	 Description	 Designation	 Benennung	 Descripció
1	07782200	TUBO FLESSIBILE	FLEXIBLE PIPE	TUYAU FLEXIBLE	SCHLAUCH	TUBO FLEXIBLE
2	07782100	TUBO FLESSIBILE	FLEXIBLE PIPE	TUYAU FLEXIBLE	SCHLAUCH	TUBO FLEXIBLE
3	07781700	TUBO FLESSIBILE	FLEXIBLE PIPE	TUYAU FLEXIBLE	SCHLAUCH	TUBO FLEXIBLE
4	07781800	TUBO FLESSIBILE	FLEXIBLE PIPE	TUYAU FLEXIBLE	SCHLAUCH	TUBO FLEXIBLE
5	07781900	TUBO FLESSIBILE	FLEXIBLE PIPE	TUYAU FLEXIBLE	SCHLAUCH	TUBO FLEXIBLE
6	07782000	TUBO FLESSIBILE	FLEXIBLE PIPE	TUYAU FLEXIBLE	SCHLAUCH	TUBO FLEXIBLE
7	07782400	TUBO FLESSIBILE	FLEXIBLE PIPE	TUYAU FLEXIBLE	SCHLAUCH	TUBO FLEXIBLE
8	07782300	TUBO FLESSIBILE	FLEXIBLE PIPE	TUYAU FLEXIBLE	SCHLAUCH	TUBO FLEXIBLE



Main color codes:  J1 - JLG Cream,  J2 - JLG Orange,  C4 - Green



 IMPIANTO IDRAULICO 1-2 BRACCI

 1-2 ARMS HYDRAULIC SYSTEM



 SYSTÈME HYDRAULIQUE 1-2 BRAS
HYDRAULIKANLAGE 1-2 ARM INSTALACIÓN HIDRÁULICA 1-2 BRAZOS 

POS	Codice	 Descrizione	 Description	 Designation	 Benennung	 Descripción
1	07784600	TUBO FLESSIBILE	FLEXIBLE PIPE	TUYAU FLEXIBLE	SCHLAUCH	TUBO FLEXIBLE
2	07784700	TUBO FLESSIBILE	FLEXIBLE PIPE	TUYAU FLEXIBLE	SCHLAUCH	TUBO FLEXIBLE
3	277099A3	CILINDRO PRIMO- SECONDO BRACCIO LL1570-X15JP-X430AJ	CYLINDER FIRST- SECOND BOOM LL1570-X15JP-X430AJ	CYLINDER	ZYLINDER	CILINDRO
3	277099H2	CILINDRO PRIMO- SECONDO BRACCIO LL1570-X15JP-X430AJ	CYLINDER FIRST- SECOND BOOM LL1570-X15JP-X430AJ	CYLINDER	ZYLINDER	CILINDRO
4	07688500	PASTIGLIA VNR STROZZATA 3/8 FORO DA Ø=2MM	VALVE	SOUPAPE	VENTIL	VALVULA
5	07688400	RACCORDO PROLUNGA M-F 3/8 H=30 FILETTO UTILE 25	FITTING	RACCORD	ANSCHLUSS	CONEXIÓN

 IMPIANTO IDRAULICO 3 BRACCIO
 3 ARM HYDRAULIC SYSTEM
 SYSTÈME HYDRAULIQUE 3 BRAS

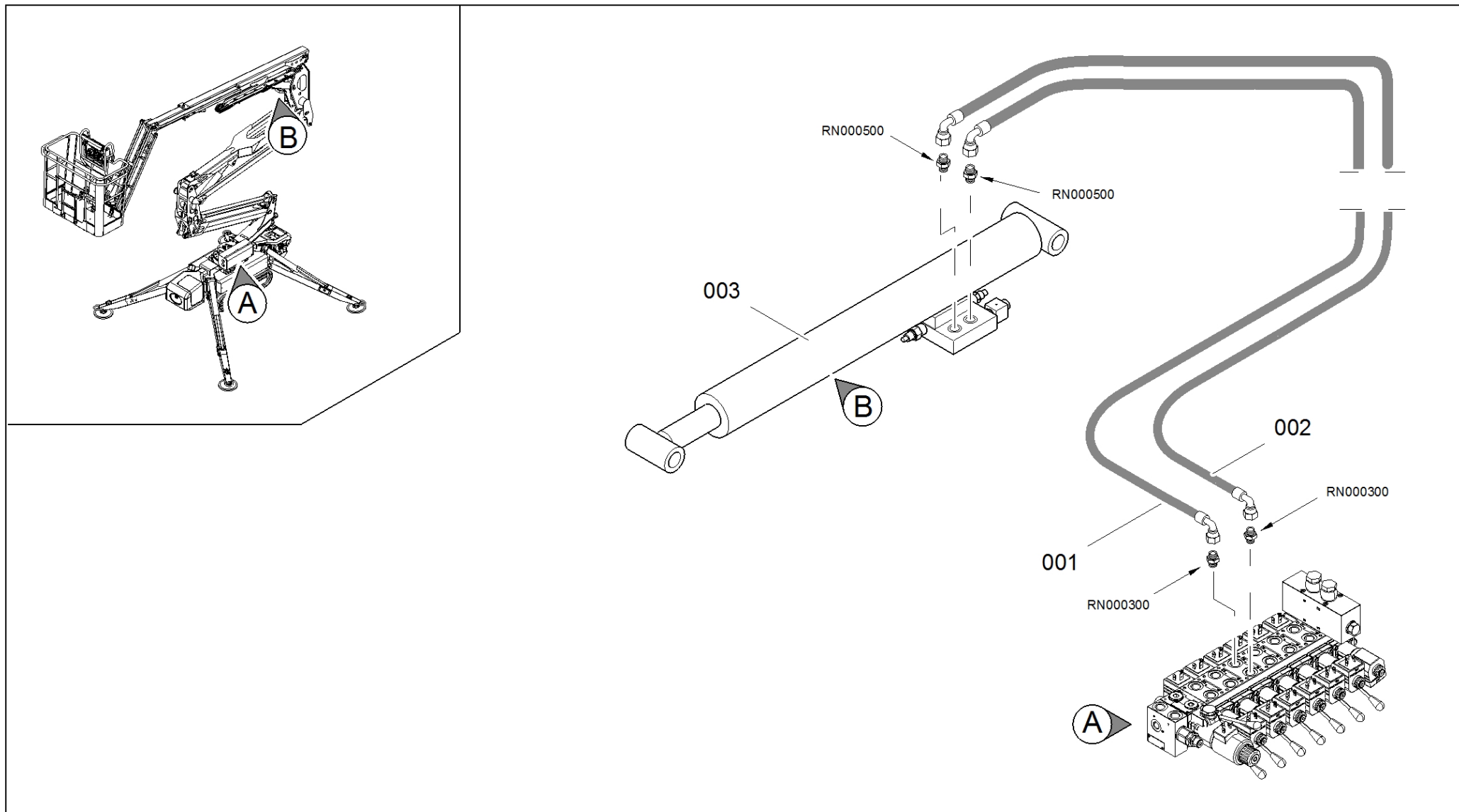
HYDRAULIKANLAGE 3 ARM 
INSTALACIÓN HIDRÁULICA 3 BRAZO 











Main color codes:  J1 - JLG Cream,  J2 - JLG Orange,  C4 - Green

 IMPIANTO IDRAULICO 3 BRACCIO





 3 ARM HYDRAULIC SYSTEM



 SYSTÈME HYDRAULIQUE 3 BRAS
HYDRAULIKANLAGE 3 ARM INSTALACIÓN HIDRÁULICA 3 BRAZO 



POS	Codice	 Descrizione	 Description	 Designation	 Benennung	 Descripción
1	07785000	TUBO FLESSIBILE	FLEXIBLE PIPE	TUYAU FLEXIBLE	SCHLAUCH	TUBO FLEXIBLE
2	07785100	TUBO FLESSIBILE	FLEXIBLE PIPE	TUYAU FLEXIBLE	SCHLAUCH	TUBO FLEXIBLE
3	277100A3	CILINDRO TERZO BRACCIO LL1570-X15JP-X430AJ	THIRD CYLINDER BOOM LL1570-X15JP-X430AJ	CYLINDRE TROISIÈME BRAS	ZYLINDER DRITTER ARM	CILINDRO TERCERO BRAZO
3	277100H2	CILINDRO TERZO BRACCIO LL1570-X15JP-X430AJ	THIRD CYLINDER BOOM LL1570-X15JP-X430AJ	CYLINDRE TROISIÈME BRAS	ZYLINDER DRITTER ARM	CILINDRO TERCERO BRAZO

 IMPIANTO IDRAULICO SFILO
 TELESCOPIC HYDRAULIC SYSTEM
 TELESCOPIQUE HIDRAULIQUE



TELESKOPHYDRAULIK 
 INSTALACIÓN EXTENSIÓN HIDRÁULICA 

POS	Codice	 Descrizione	 Description	 Designation	 Benennung	 Descripción
1	07785200	TUBO FLESSIBILE	FLEXIBLE PIPE	TUYAU FLEXIBLE	SCHLAUCH	TUBO FLEXIBLE
2	07785300	TUBO FLESSIBILE	FLEXIBLE PIPE	TUYAU FLEXIBLE	SCHLAUCH	TUBO FLEXIBLE
3	07753700	TUBO RIGIDO	RIGID PIPE	TUYAU	SCHLAUCH	TUBO
4	07753800	TUBO RIGIDO	RIGID PIPE	TUYAU	SCHLAUCH	TUBO
5	277101H2	CILINDRO SFILO LL1570	CYLINDER EXTENSION LL1570	CYLINDRE	ZYLINDER	CILINDRO



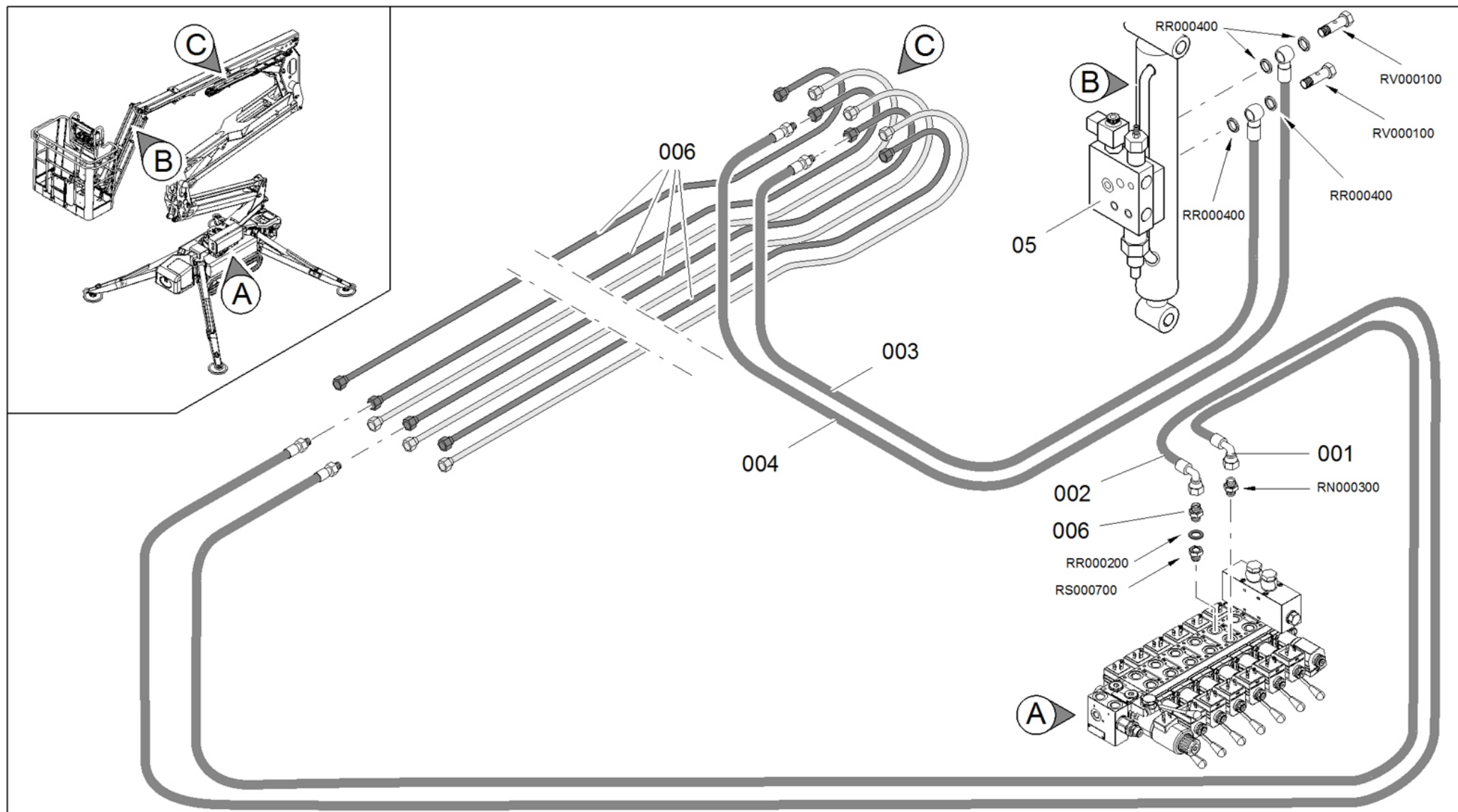

 IMPIANTO JIB
 JIB HYDRAULIC SYSTEM
 SYSTÈME HYDRAULIQUE JIB



ZYLINDER JIB ARM 
 INSTALACIÓN HIDRÁULICA JIB 







Main color codes:  **J1** - JLG Cream,  **J2** - JLG Orange,  **C4** - Green

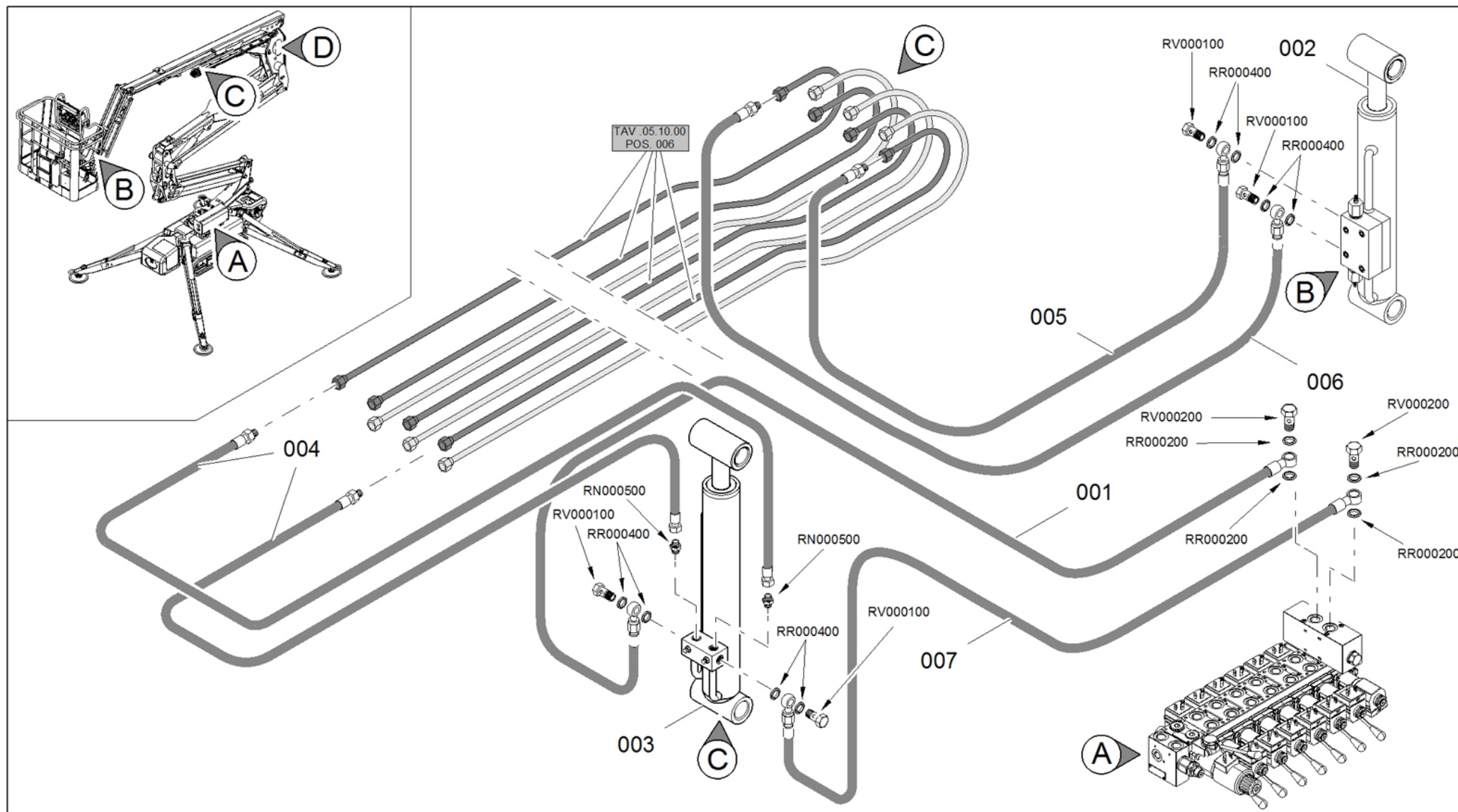

 IMPIANTO JIB JIB HYDRAULIC SYSTEM SYSTÈME HYDRAULIQUE JIBZYLINDER JIB ARM INSTALACIÓN HIDRÁULICA JIB 





POS	Codice	 Descrizione	 Description	 Designation	 Benennung	 Descripción
1	07785700	TUBO FLESSIBILE	FLEXIBLE PIPE	TUYAU FLEXIBLE	SCHLAUCH	TUBO FLEXIBLE
2	07785600	TUBO FLESSIBILE	FLEXIBLE PIPE	TUYAU FLEXIBLE	SCHLAUCH	TUBO FLEXIBLE
3	07786400	TUBO FLESSIBILE	FLEXIBLE PIPE	TUYAU FLEXIBLE	SCHLAUCH	TUBO FLEXIBLE
4	07786300	TUBO FLESSIBILE	FLEXIBLE PIPE	TUYAU FLEXIBLE	SCHLAUCH	TUBO FLEXIBLE
5	270695A3	CILINDRO SFILO	EXTENSION CYLINDER	CYLINDRE SECT.TÉLESCOP.	TELESKOPZYLINDER	CIL. BRAZO TELESCÓP.
5	270695H2	CILINDRO JIB	JIB CYLINDER	CYLINDRE JIB	KORBARMZYLINDER	CILINDRO JIB
6	07753900	TUBO RIGIDO	RIGID PIPE	TUYAU	SCHLAUCH	TUBO



Main color codes:  J1 - JLG Cream,  J2 - JLG Orange,  C4 - Green







 IMPIANTO IDRAULICO LIVELLAMENTO
 LEVELING CYLINDERS HYDRAULIC SYSTEM
 SYSTÈME HYDRAULIQUE CYLINDRES BRAS

HYDRAULIKANLAGE ZYLINDER ARM 
 INSTALACIÓN HIDRÁULICA CILINDROS BRAZOS 



POS	Codice	 Descrizione	 Description	 Designation	 Benennung	 Descripción
1	07784900	TUBO FLESSIBILE	FLEXIBLE PIPE	TUYAU FLEXIBLE	SCHLAUCH	TUBO FLEXIBLE
2	273151A3	CILINDRO LIVELLAMENTO CESTO SU CESTO	CYLINDER LEVEL BASKET ON BASKET	CYLINDRE SUR LEVEL BASKET BASKET	ZYLINDER AUF LEVEL WARENKORB WARENKORB	CILINDRO DE NIVEL DE BASKET BASKET
2	273151H2	CILINDRO LIVELLAMENTO CESTO SU CESTO	LEVELING CYLINDER BASKET ON BASKET	CYLINDRE NIVELLEMENT PANIER SUR PANIER	ZYLINDER KORBNIVELLIERUNG	CILINDRO NIVELACIÓN CESTA
3	270693A3	CILINDRO SFILO	EXTENSION CYLINDER	CYLINDRE SECT.TÉLESCOP.	TELESKOPZYLINDER	CIL. BRAZO TELESCÓP.
3	270693H2	CILINDRO LIVELLAMENTO CESTO	BASKET LEVELLING CYLINDER	CYLINDRE NIVELLEMENT PANIER	ZYLINDER KORBNIVELLIERUNG	CILINDRO NIVELACIÓN CESTA
4	07786000	TUBO FLESSIBILE	FLEXIBLE PIPE	TUYAU FLEXIBLE	SCHLAUCH	TUBO FLEXIBLE
5	07786200	TUBO FLESSIBILE	FLEXIBLE PIPE	TUYAU FLEXIBLE	SCHLAUCH	TUBO FLEXIBLE
6	07786100	TUBO FLESSIBILE	FLEXIBLE PIPE	TUYAU FLEXIBLE	SCHLAUCH	TUBO FLEXIBLE
7	07784800	TUBO FLESSIBILE	FLEXIBLE PIPE	TUYAU FLEXIBLE	SCHLAUCH	TUBO FLEXIBLE

Main color codes:  J1 - JLG Cream,  J2 - JLG Orange,  C4 - Green

 IMPIANTO IDRAULICO ROTAZIONE CESTO
 CAGE ROTATION HYDRAULIC SYSTEM
 SYSTÈME HYDRAULIQUE ROTATION PANIER

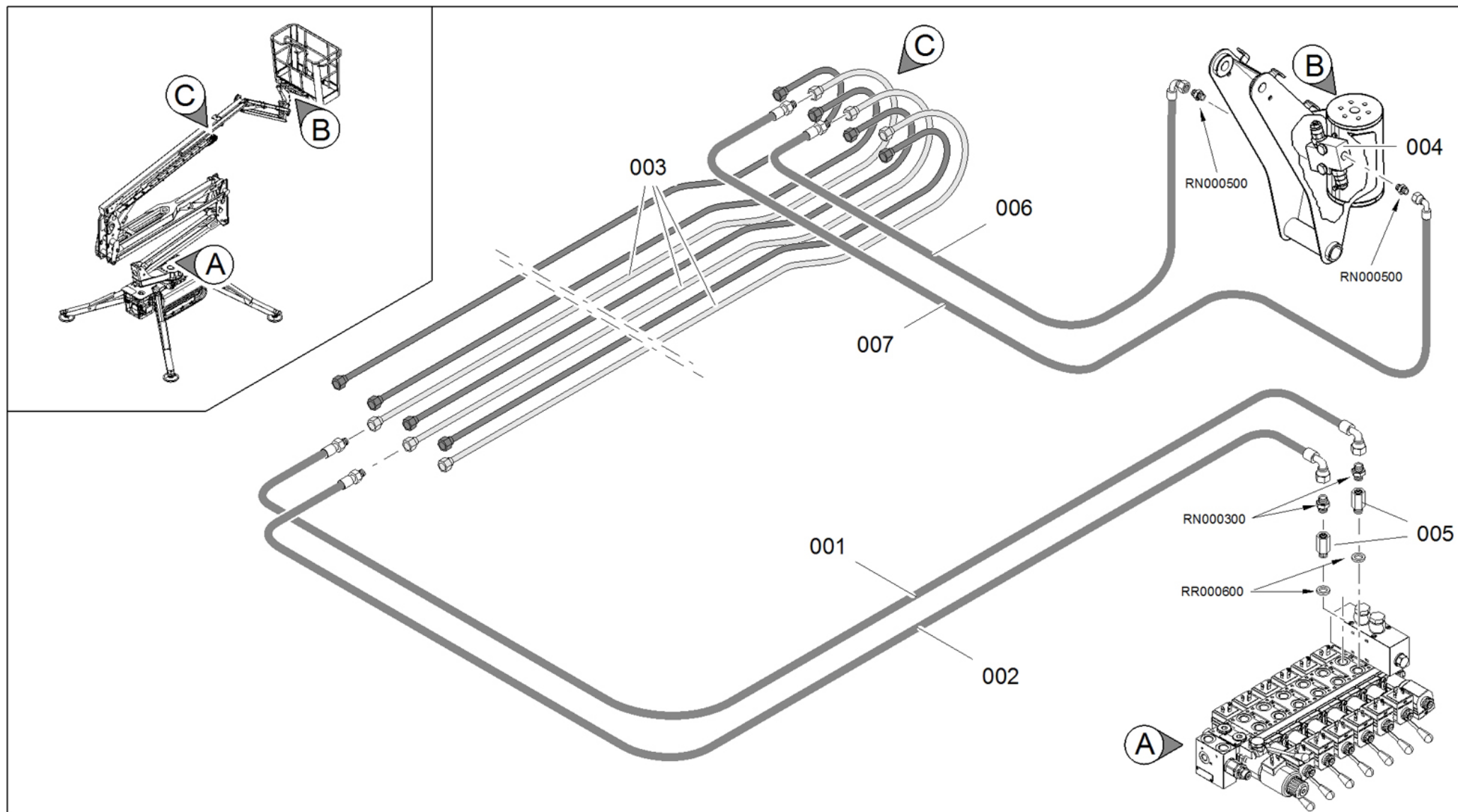
HYDRAULIKANLAGE KORBSCHWENKUNG 
 INSTALACIÓN HIDRÁULICA ROTACIÓN CESTA 









Main color codes:  J1 - JLG Cream,  J2 - JLG Orange,  C4 - Green

 IMPIANTO IDRAULICO ROTAZIONE CESTO

 CAGE ROTATION HYDRAULIC SYSTEM

 SYSTÈME HYDRAULIQUE ROTATION PANIER

 HYDRAULIKANLAGE KORBSCHWENKUNG 
 INSTALACIÓN HIDRÁULICA ROTACIÓN CESTA 

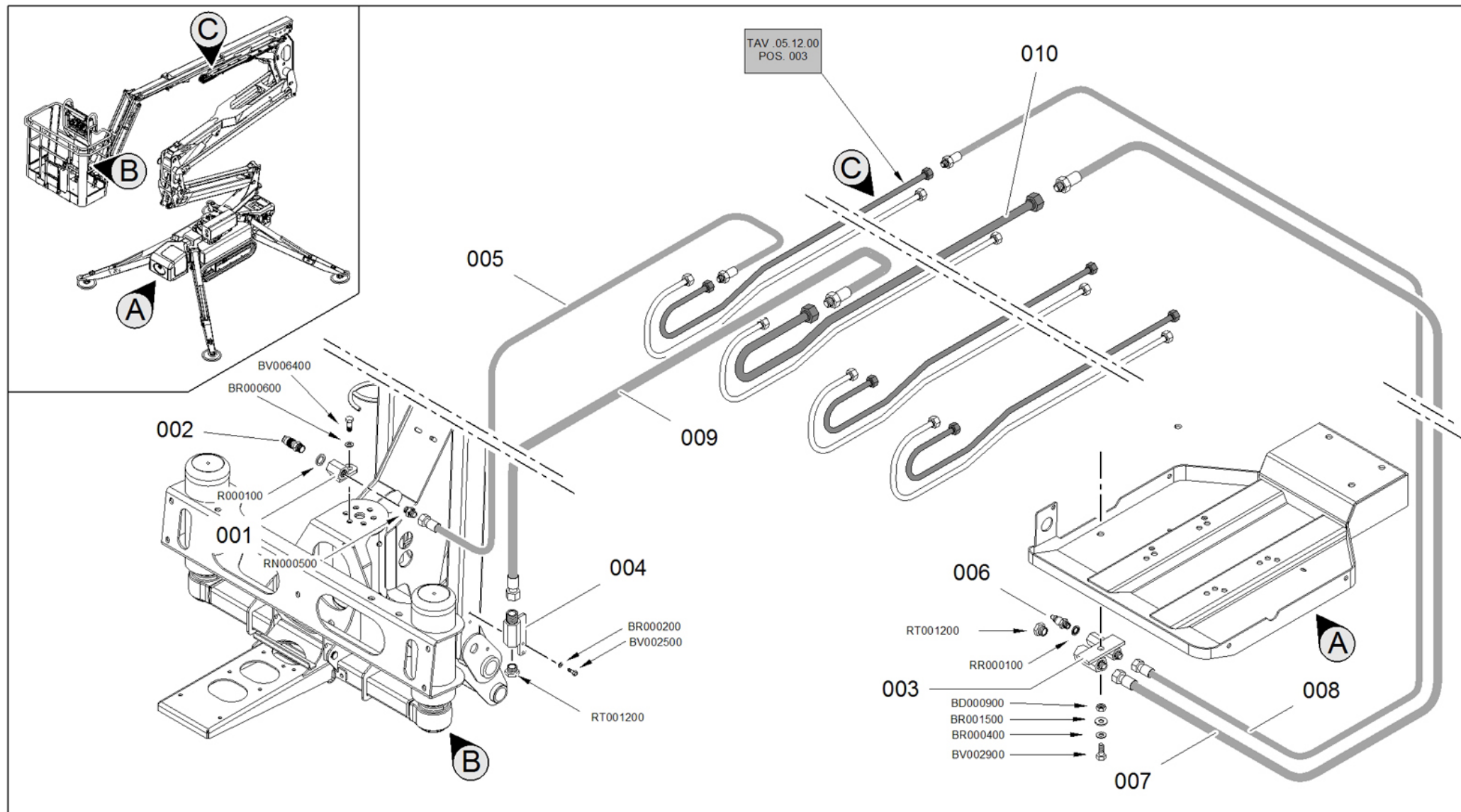

POS	Codice	 Descrizione	 Description	 Designation	 Benennung	 Descripción
1	07785800	TUBO FLESSIBILE	FLEXIBLE PIPE	TUYAU FLEXIBLE	SCHLAUCH	TUBO FLEXIBLE
2	07785900	TUBO FLESSIBILE	FLEXIBLE PIPE	TUYAU FLEXIBLE	SCHLAUCH	TUBO FLEXIBLE
3	07754000	TUBO RIGIDO	RIGID PIPE	TUYAU	SCHLAUCH	TUBO
4	2648910001	VALVOLA IDRAULICA	HYDRAULIC VALVE	VALVE HYDRAULIQUE	HYDRAULIKVENTIL	VÁLVULA HIDRÁULICA
5	03149500	RACCORDO A COLONNA 3/8" H=20	EXTENSION 3/8" H=20	RACCORD	ANSCHLUSS	CONEXIÓN
6	07786500	TUBO FLESSIBILE	FLEXIBLE PIPE	TUYAU FLEXIBLE	SCHLAUCH	TUBO FLEXIBLE
7	07786600	TUBO FLESSIBILE	FLEXIBLE PIPE	TUYAU FLEXIBLE	SCHLAUCH	TUBO FLEXIBLE







 IMPIANTO IDRAULICO ARIA COMPRESSA



 COMPRESSED AIR HYDRAULIC SYSTEM

 SYSTÈME HYDRAULIQUE AIR COMPRIMÉ

 HYDRAULIKANLAGE DRUCKLUFT 
 INSTALACIÓN HIDRÁULICA AIRE COMPRIMIDO 

POS	Codice	 Descrizione	 Description	 Designation	 Benennung	 Descripción
1	04845100	SUPPORTO	SUPPORT	SUPPORT	HALTERUNG	SOPORTE
2	05509900	INNESTO RAPIDO	QUICK COUPLING	RACCORD RAPIDE	SCHNELLKUPPLUNG	CONEXIÓN RÁPIDA
3	07611000	RACCORDO	PIPE FITTING	TUYAU	ANSCHLUSS	MANGUITO
4	07611100	RACCORDO	HOSE FITTING	TUYAU	ANSCHLUSS	CONEXIÓN
5	07786700	TUBO FLESSIBILE	FLEXIBLE PIPE	TUYAU FLEXIBLE	SCHLAUCH	TUBO FLEXIBLE
6	05580200	RUBINETTO	FAUCET	ROBINET	WASSERHAHN	GRIFO
7	07785400	TUBO FLESSIBILE	FLEXIBLE PIPE	TUYAU FLEXIBLE	SCHLAUCH	TUBO FLEXIBLE
8	07785500	TUBO FLESSIBILE	FLEXIBLE PIPE	TUYAU FLEXIBLE	SCHLAUCH	TUBO FLEXIBLE
9	07786800	TUBO FLESSIBILE	FLEXIBLE PIPE	TUYAU FLEXIBLE	SCHLAUCH	TUBO FLEXIBLE
10	07754100	TUBO RIGIDO	RIGID PIPE	TUYAU	SCHLAUCH	TUBO

 CILINDRI
 CYLINDERS
 CYLINDRES

ZYLINDER 
 CILINDROS 

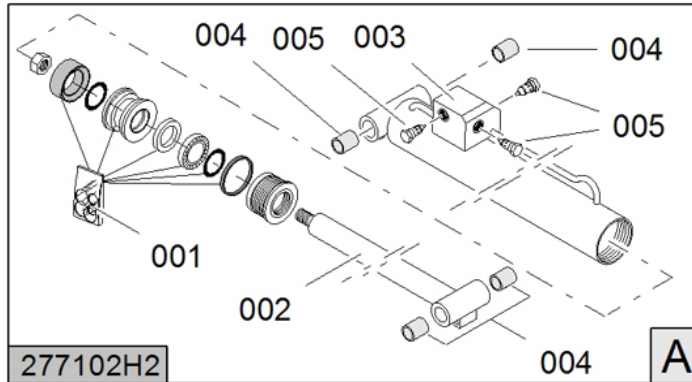

277102H2 004 **A**

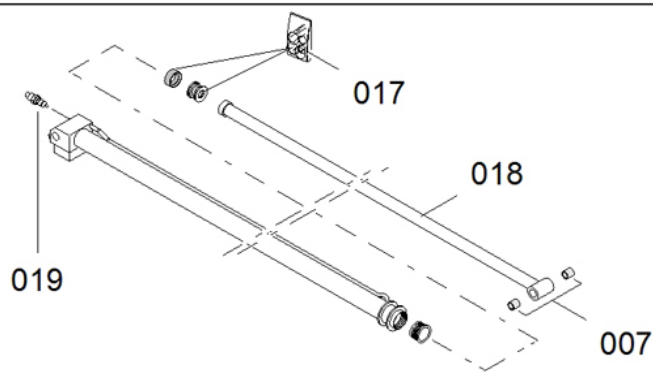

277101H2 **D**

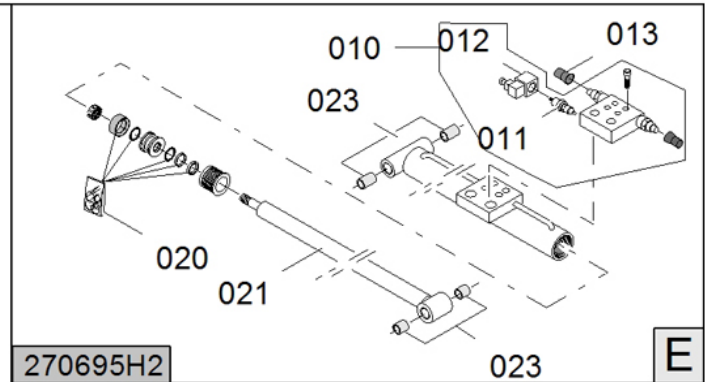

270695H2 023 **E**

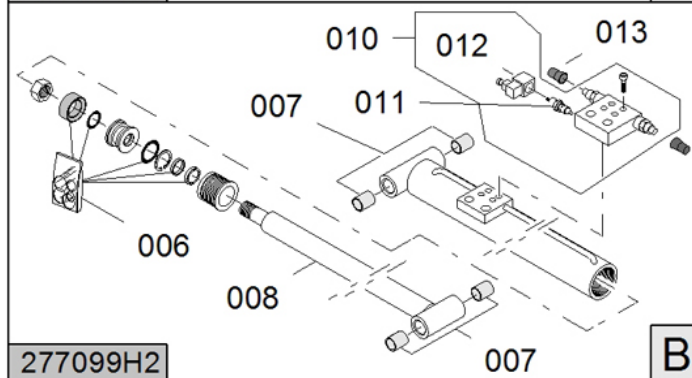

277099H2 007 **B**

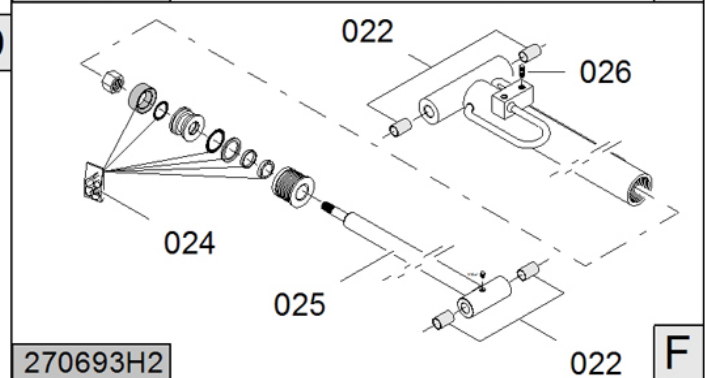
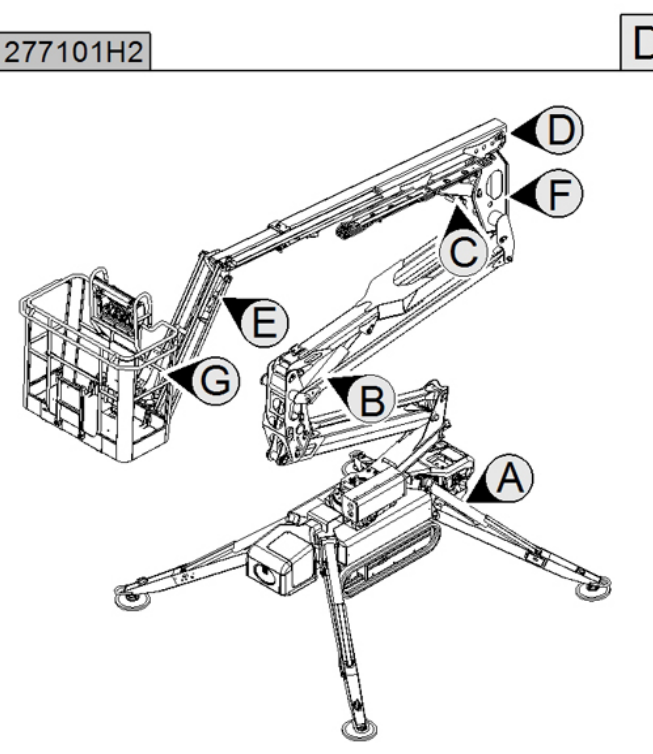

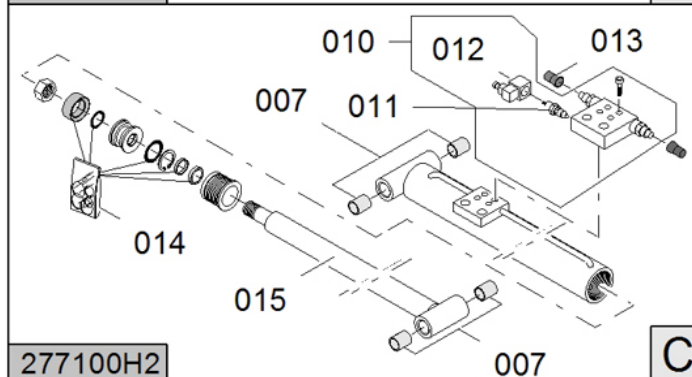

270693H2 022 **F**



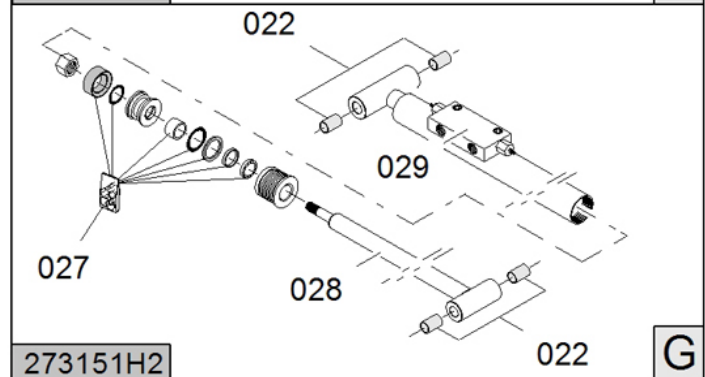

277100H2 007 **C**









273151H2 022 **G**

Main color codes:  J1 - JLG Cream,  J2 - JLG Orange,  C4 - Green



 CILINDRI
 CYLINDERS
 CYLINDRES





ZYLINDER 
 CILINDROS 



POS	Codice	 Descrizione	 Description	 Designation	 Benennung	 Descripción
1	2827490002	KIT GUARNIZIONI CILINDRO BRACCIO 1 LL1570-X15JP-X430AJ	SEAL KIT CYLINDER FIRST BOOM LL1570- X15JP-X430AJ	KIT JOINTS	DICHTUNGSSATZ	KIT JUNTAS
2	282209H201	STELO CILINDRO STABILIZZATORE	ROD CYLINDER STABILIZER	TIGE VÉRIN STABILISATEUR	STÜTZFUßZYLINDER KOLBENSTANGE	VÁSTAGO CILINDRO ESTABILIZADOR
3	2705540002	BLOCCHETTO	BLOCK	BLOC	BLOCK	BLOQUE
4	07765500	BOCCOLA	BUSH	DOUILLE	BUCHSE	CASQUILLO
5	1541150011	VALVOLA IDRAULICA	HYDRAULIC VALVE	VALVE HYDRAULIQUE	HYDRAULIKVENTIL	VÁLVULA HIDRÁULICA
6	2770990002	KIT GUARNIZIONI CILINDRO BRACCIO 1 LL1570-X15JP-X430AJ	SEAL KIT CYLINDER FIRST BOOM LL1570- X15JP-X430AJ	KIT JOINTS	DICHTUNGSSATZ	KIT JUNTAS
7	07765200	BOCCOLA DEVA.TEX552 303530	BUSH DEVA.TEX 552 303530	DOUILLE	BUCHSE	CASQUILLO
8	2770990001	STELO CILINDRO BRACCIO 1 LL1570- X15JP-X430AJ	ROD CYLINDER FIRST BOOM LL1570-X15JP- X430AJ	TIGE CYLINDER	ZYLINDERSCHAFT	VÁSTAGO CILINDRO
10	26119300	VALVOLA IDRAULICA	HYDRAULIC VALVE	VALVE HYDRAULIQUE	HYDRAULIKVENTIL	VÁLVULA HIDRÁULICA
11	0552550001	ELETTROVALVOLA	SOLENOID VALVE	ÉLECTROVANNE	MAGNETVENTIL	ELECTROVÁLVULA
12	0552550003	BOBINA	COIL	BOBINE	SPULE	BOBINA
13	05576200	PROTEZIONE	PROTECTION	PROTECTION	SCHUTZ	PROTECCIÓN
14	2771000002	KIT GUARNIZIONI CILINDRO BRACCIO 3 LL1570-X15JP-X430AJ	SEAL KIT CYLINDER THIRD BOOM LL1570- X15JP-X430AJ	KIT JOINTS	DICHTUNGSSATZ	KIT JUNTAS
15	2706920003	SENSORE LINEARE CILINDRO	CYLINDER LINEAR SENSOR	CAPTEUR	SENSOR	SENSOR
15	2771000001	STELO CILINDRO BRACCIO 3 LL1570- X15JP-X430AJ	ROD CYLINDER THIRD BOOM LL1570- X15JP-X430AJ	TIGE CYLINDRE	ZYLINDERSCHAFT	VÁSTAGO CILINDRO
17	2771010002	KIT GUARNIZIONI CILINDRO SFILO LL1570-X15JP-X430AJ	SEAL KIT CYLINDER SFILO LL1570-X15JP- X430AJ	KIT JOINTS	DICHTUNGSSATZ	KIT JUNTAS

Main color codes:  J1 - JLG Cream,  J2 - JLG Orange,  C4 - Green

 CILINDRI
 CYLINDERS
 CYLINDRES



ZYLINDER 
 CILINDROS 

POS	Codice	 Descrizione	 Description	 Designation	 Benennung	 Descripción
18	2771010001	STELO CILINDRO SFILO LL1570-X15JP- X430AJ	ROD CYLINDER SFILO LL1570-X15JP-X430AJ	TIGE CYLINDRE	ZYLINDERSCHAFT	VÁSTAGO CILINDRO
19	2630690003	VALVOLA IDRAULICA	HYDRAULIC VALVE	VALVE HYDRAULIQUE	HYDRAULIKVENTIL	VÁLVULA HIDRÁULICA
20	2706950001	KIT GUARNIZIONI CILINDRO JIB	SEAL KIT CYLINDER JIB	KIT DE JOINTS	DICHTUNGSSATZ	KIT JUNTAS CILINDRO JIB
21	2706950002	STELO CILINDRO JIB	ROD CYLINDER JIB	TIGE DE CYLINDRE JIB	KORBARM ZYLINDERSCHAFT	VASTAGO CILINDRO JIB
22	2627890006	BOCCOLA	BUSH	DOUILLE	BUCHSE	CASQUILLO
23	2627910006	BOCCOLA	BUSH	DOUILLE	BUCHSE	CASQUILLO
24	2706930001	KIT GUARNIZIONI CILINDRO LIVELLAMENTO SU RINVIO	CYLINDER GASKET KIT	KIT DE JOINTS CYLINDRE NIVELLEMENT	DICHTSATZ ZYLINDER AUSNIVELLIERUNG	KIT DE JUNTAS CILINDRO NIVELACIÓN
25	2706930002	STELO CILINDRO LIVELLAMENTO SU RINVIO	ROD CYLINDER	TIGE CYLINDRE	ZYLINDERSCHAFT	VASTAGO CILINDRO
26	2588290008	VITE	SCREW	VIS	SCHRAUBE	TORNILLO
27	2706940001	KIT GUARNIZIONI CILINDRO LIVELLAMENTO SU CESTO	CYLINDER GASKET KIT	KIT DE JOINTS CYLINDRE NIVELLEMENT	DICHTSATZ	KIT JUNTAS
28	2706940002	STELO CILINDRO LIVELLAMENTO SU CESTO	BASKET LEVELING CYLINDER ROD ON BASKET	CYLINDRE TIGE	ZYLINDERSCHAFT	VASTAGO CILINDRO
29	2731510003	VALVOLA IDRAULICA	HYDRAULIC VALVE	VALVE HYDRAULIQUE	HYDRAULIKVENTIL	VÁLVULA HIDRÁULICA

 COMPONENTI IMPIANTO ELETTRICO
 ELECTRICAL SYSTEM COMPONENTS
 COMPOSANTS INSTALLATION ÉLECTRIQUE

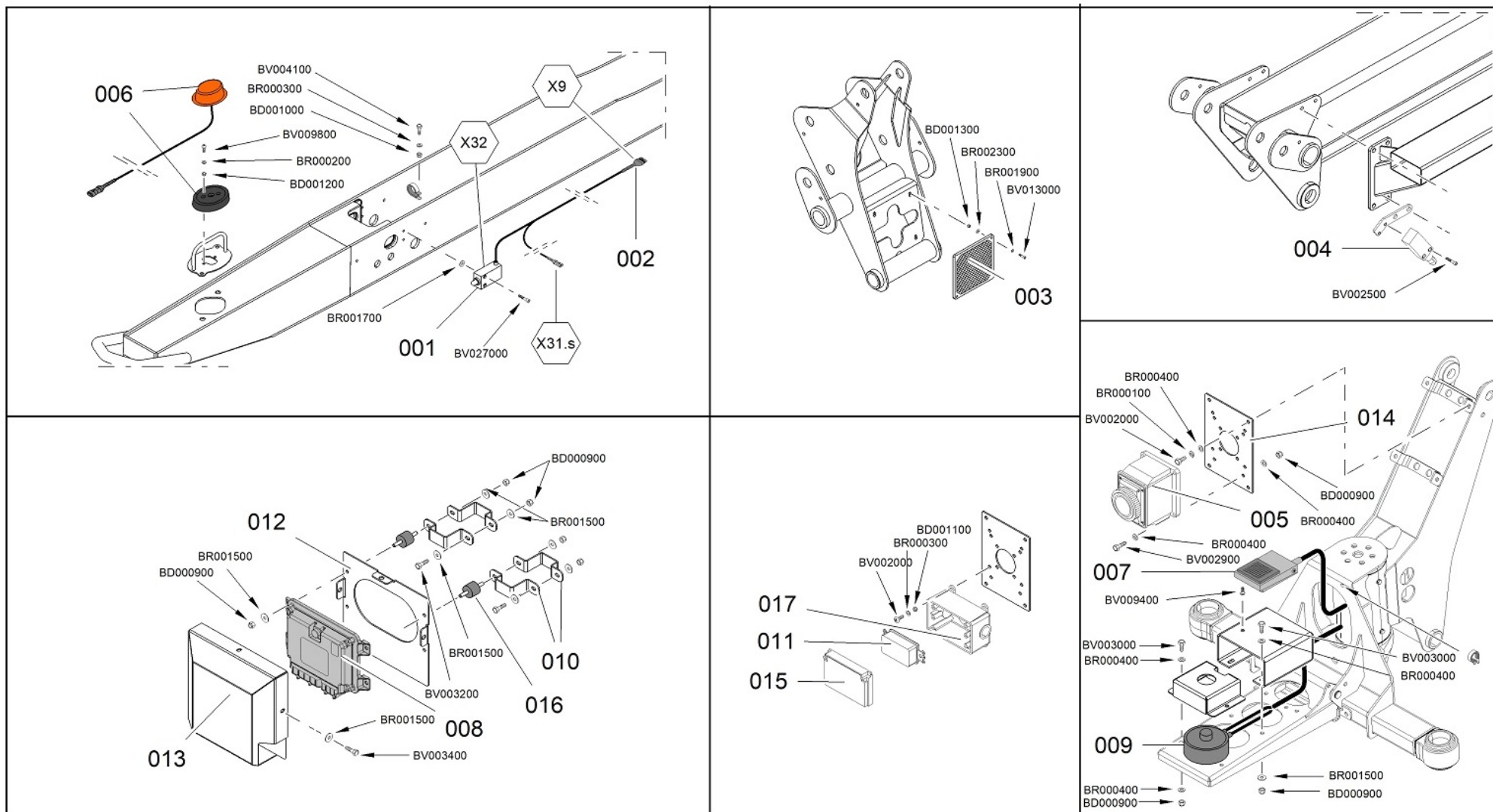
KOMONENTEN ELEKTROANLAGE 
 COMPONENTES INSTALACIÓN ELÉCTRICA 









Main color codes:  J1 - JLG Cream,  J2 - JLG Orange,  C4 - Green



 COMPONENTI IMPIANTO ELETTRICO

 ELECTRICAL SYSTEM COMPONENTS

 COMPOSANTS INSTALLATION ÉLECTRIQUE

 KOMponenten Elektroanlage 
 Componentes Instalación Eléctrica 



POS	Codice	 Descrizione	 Description	 Designation	 Benennung	 Descripción
1	1772950011	MICROINTERRUTTOR E 2 CONTATTI NC/NO TESTINA PULSANTE CAVO LUNGO 2 METRI	MICRO SWITCH CONTACT 2 NC / NO BUTTON HEAD CABLE 2 METER	MICROINTERRUPTEU R	MIKROSCHALTER	MICROINTERRUPTOR
2	1772950012	CAVO PROLUNGA STABILIZZATORE LL1570-X15JP-X430AJ	EXTENSION CABLE STABILIZER LL1570- X15JP-X430AJ	CÂBLE	KABEL	CABLE
3	1679890001	CATARIFRANGENTE 100X100 MM	REFLECTOR 100X100 MM	CATADIOPTRE	REFLEKTOR	CATADIÓPTRICO
4	1679900012	MICROINTERRUTTOR E 2 CONTATTI NC/NO TESTINA ROTELLA ACCIAIO CAVO LUNGO 5 METRI	MICRO SWITCH CONTACT 2 NC / NO HEAD STEEL WHEEL LONG CABLE 5 METER	MICROINTERRUPTEU R	MIKROSCHALTER	MICROINTERRUPTOR
5	1585570005	PRESA ELETTRICA 230V	ELECTRICAL SOCKET 230V	PRISE ÉLECTRIQUE	STECKDOSE	ENCHUFE ELÉCTRICO
5	1591700002	PRESA ELETTRICA 110V	ELECTRICAL SOCKET 110V	PRISE ÉLECTRIQUE 110V	STECKDOSE 110V	ENCHUFE ELÉCTRICO 110V
6	1757250023	SPIA STABILIZZATORE LED COMPLETA DI CONNETTORE	LED LIGHT	TEMOIN LED	KONTROLLAMPE	INDICADOR LED
7	1772950015	INTERRUTTORE A PEDALE COMPLETO DI CAVO E CONNETTORE TRE VIE CONTATTO NC/NO	FOOT SWITCH COMPLETE WITH CABLE AND CONNECTOR THREE- WAY CONTACT NC/NO	INTERRUPTEUR	SCHALTER	INTERRUPTOR





 Main color codes:  J1 - JLG Cream,  J2 - JLG Orange,  C4 - Green



 COMPONENTI IMPIANTO ELETTRICO

 ELECTRICAL SYSTEM COMPONENTS

 COMPOSANTS INSTALLATION ÉLECTRIQUE

 KOMponenten Elektroanlage 
 Componentes Instalación Eléctrica 

POS	Codice	 Descrizione	 Description	 Designation	 Benennung	 Descripción
8	1772950016	SCHEDA 48XS CON BOOTLOADER 1.2.0, VERSIONE SOFTWARE PER MACCHINE CE E ANSI CON MOTORE TERMICO E LITIO	X48S BOARD WITH BOOTLOADER 1.2.0, SOFTWARE VERSION FOR CE AND ANSI MARKET WITH ENGINE THERMIC AND LITIO	CARTE ÉLECTRONIQUE	ELEKTRONISCHE PLATINE	TARJETA ELECTRÓNICA
9	17669800	SENSORE CELLA DI CARICO 4-20MA COMPLETO DI CAVO E CONNETTORI M12 (MK2)	SENSOR LOAD CELL 4-20MA WITH CABLE AND CONNECTORS M12 (MK2 VERSION)	CELLULE DE CHARGE (MK2)	MESSDOSE (MK2)	CÉLULA DE CARGA (MK2)
10	077090A6	COLLARE FISSAGGIO SCHEDA CELLA DI CARICO TTC	COLLAR FIXING SHEET LOAD CELL TTC	BRIDE	BUNDRING	ABRAZADERA
10	077090H2	COLLARE FISSAGGIO SCHEDA CELLA DI CARICO TTC	COLLAR FIXING SHEET LOAD CELL TTC	BRIDE	BUNDRING	ABRAZADERA
11	27073700	BOX PRESE USA AL CESTO, RECEPTACLE PART N°:0861731	US SOCKET BOX TO BASKET, RECEPTACLE PART N°:0861731	BOX PRISES	SCHACHTEL STECKDOSEN	CAJA ENCHUFES
12	077091A6	PIASTRA FISSAGGIO SCHEDA CELLA DI CARICO TTC	FIXING PLATE LOAD CELL CARD TTC	PLAQUE	PLATTE	PLACA
12	077091H2	PIASTRA FISSAGGIO SCHEDA CELLA DI CARICO TTC	FIXING PLATE LOAD CELL CARD TTC	PLAQUE	PLATTE	PLACA
13	077712A6	CARTER PROTEZIONE SCHEDA CELLA DI CARICO TTC	CARTER PROTECTION CELL CARD LOAD TTC	CARTER	KURBELGEHÄUSE	CÁRTER
13	077712H2	CARTER PROTEZIONE SCHEDA CELLA DI CARICO TTC	CARTER PROTECTION CELL CARD LOAD TTC	CARTER	KURBELGEHÄUSE	CÁRTER





 Main color codes:  J1 - JLG Cream,  J2 - JLG Orange,  C4 - Green



 COMPONENTI IMPIANTO ELETTRICO

 ELECTRICAL SYSTEM COMPONENTS

 COMPOSANTS INSTALLATION ÉLECTRIQUE



 KOMponenten Elektroanlage 
 Componentes Instalación Eléctrica 

POS	Codice	 Descrizione	 Description	 Designation	 Benennung	 Descripción
14	077089A6	PIASTRA FISSAGGIO PRESE SU CESTO TTC	FIXING PLATE PLUGS ON BASKET TTC	PLAQUE	PLATTE	PLACA
14	077089H2	PIASTRA FISSAGGIO PRESE SU CESTO TTC	FIXING PLATE PLUGS ON BASKET TTC	PLAQUE	PLATTE	PLACA
15	27073800	COVER PRESE USA AL CESTO, RECEPTACLE BOX PART N°:1671207	COVER US SOCKETS TO BASKET, RECEPTACLE BOX PART N°:1671207	PRETECTION	SCHUTZ	PROTECCIÓN
16	04152300	SUPPORTO ELASTICO SUPERIORE RADIATORE -	SPRING SUPPORT	SUPPORT ELASTIQUE	FEDERAUFLAGE	SOPORTE ELASTICO
16	27073900	PLUG PRESE USA AL CESTO, RECEPTACLE PART N°:4460346	US SOCKETS TO BASKET, RECEPTACLE PART N°:4460346	PRISE	STECKDOSE	ENCHUFE

 COMPONENTI IMPIANTO ELETTRICO
 ELECTRICAL SYSTEM COMPONENTS
 COMPOSANTS INSTALLATION ÉLECTRIQUE

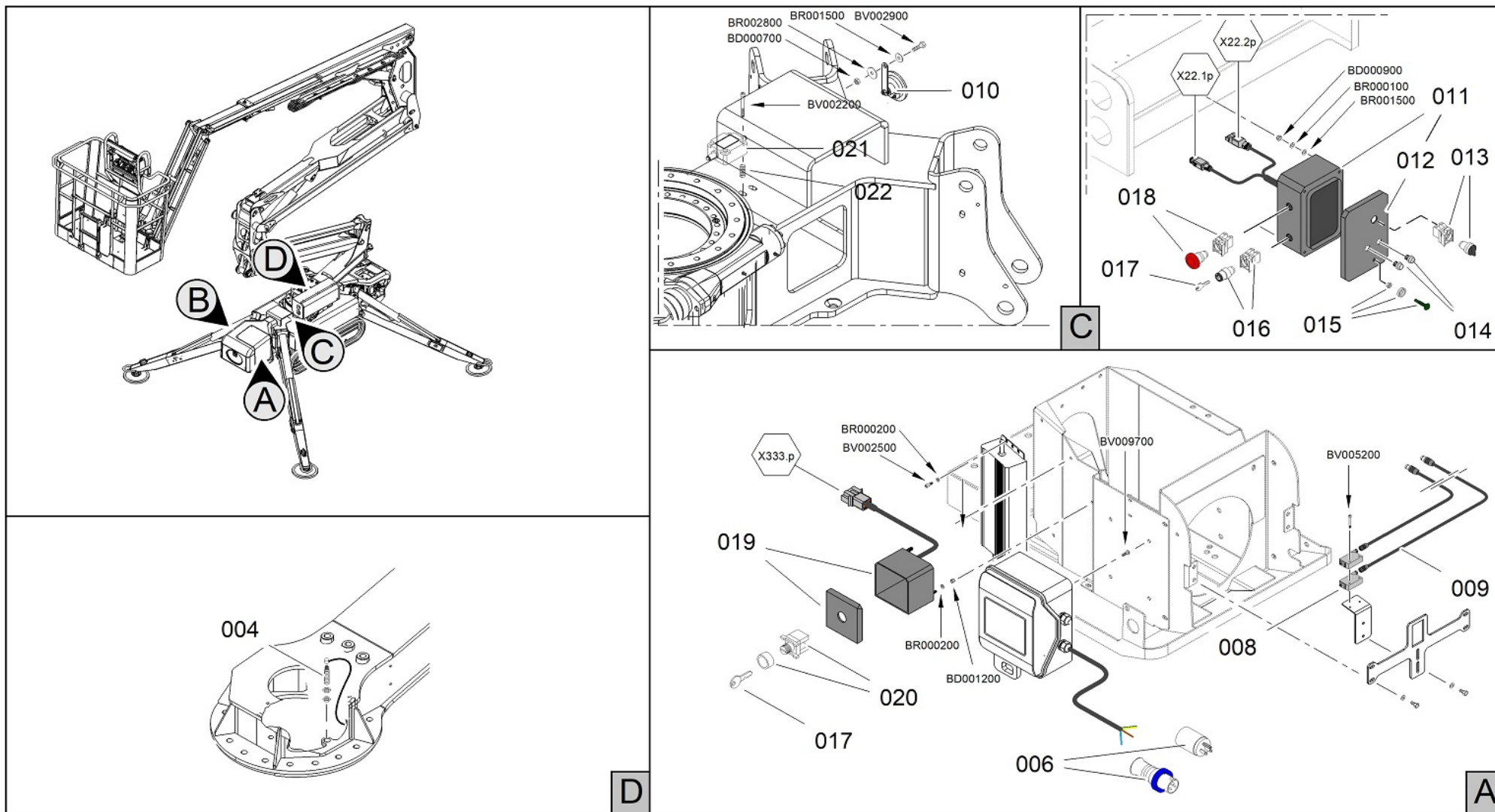
KOMponenten Elektroanlage 
 COMPONENTES INSTALACIÓN ELÉCTRICA 









Main color codes:  J1 - JLG Cream,  J2 - JLG Orange,  C4 - Green



 COMPONENTI IMPIANTO ELETTRICO

 ELECTRICAL SYSTEM COMPONENTS

 COMPOSANTS INSTALLATION ÉLECTRIQUE

 KOMONENTEN ELEKTROANLAGE 
 COMPONENTES INSTALACIÓN ELÉCTRICA 



POS	Codice	 Descrizione	 Description	 Designation	 Benennung	 Descripción
4	1651290010	SENSORE DI PROSSIMITÀ	PROXIMITY SENSOR	CAPTEUR DE PROXIMITÉ	NÄHERUNGSSENSOR	SENSOR DE PROXIMIDAD
6	1757250001	SPINA VOLANTE 230V 16A	FREE PLUG 230V 16A	FICHE	STECKER	ENCHUFE
6	1757250002	SPINA VOLANTE 110V 32A	FREE PLUG 110V 32A	CHEVILLE	STIF	CLAVIJA
6	1757250003	SPINA VOLANTE 110V 16A	FREE PLUG 110V 16A	CHEVILLE	STIF	CLAVIJA
6	27074000	TERMINAL PRESA USA A TERRA, CONN PLUG PART N°:4460138	TERMINAL GROUND SOCKET USA, CONN PLUG PART N °: 4460138	CONNECTEUR	VERBINDER	CONECTOR
7	27396100	ANTENNA	AERIAL	ANTENNE	ANTENNE	ANTENA
8	1591270001	FOTOCELLULA	PHOTOCELL	CELLULE PHOTO-ÉLECTRIQUE	PHOTOZELLE	FOTOCÉLULA
9	159127000101	CAVO ELETTRICO	ELECTRIC CABLE	CÂBLE ÉLECTRIQUE	ELEKTROKABEL	CABLE ELÉCTRICO
10	04834500	CLAXON 12V	HORN	KLAXON	HORN	BOCINA
11	175726002402	SCATOLA STOP A TERRA MK2 E LL2614 VUOTA	STOP BOX MK2 AND LL2614 EMPTY	BOÎTE STOP	KASTEN STOP	CAJA STOP
11	1770750001	SCATOLA STOP A TERRA LITHIUM LL26/X26/X770 LL15/X15/X430 TT COMPLETA DI CABLAGGIO E CONNETTORE	BOX WITH WIRING	BOÎTE AVEC CÂBLAGE	KASTEN MIT VERKABELUNG	CAJA CON CABLEADO
11	1773980003	SCATOLA STOP A TERRA DIESEL LL2614-X26JP-X770AJ TT COMPLETA DI CABLAGGIO E CONNETTORE	BOX WITH WIRING	BOÎTE AVEC CÂBLAGE	KASTEN MIT VERKABELUNG	CAJA CON CABLEADO

 Main color codes:  J1 - JLG Cream,  J2 - JLG Orange,  C4 - Green



 COMPONENTI IMPIANTO ELETTRICO

 ELECTRICAL SYSTEM COMPONENTS

 COMPOSANTS INSTALLATION ÉLECTRIQUE

 KOMponenten Elektroanlage 
 Componentes Instalación Eléctrica 

POS	Codice	 Descrizione	 Description	 Designation	 Benennung	 Descripción
12	175726002401	COPERCHIO SCATOLA STOP A TERRA DIESEL LL2614-X26JP- X770AJ	BOX COVER	COUVERCLE BOÎTE	KASTENABDECKUNG	TAPA DE CAJA
12	175727000201	COPERCHIO SCATOLA STOP A TERRA LITHIUM 83V	BOX COVER	COUVERCLE BOÎTE	KASTENABDECKUNG	TAPA DE CAJA
13	1556350068	SELETTORE A LEVA 3 POSIZIONI	3 POSITION LEVER SWITCH	SÉLECTEUR	WÄHLSCHALTER	SELECTOR
14	1628400005	PULSANTE	BUTTON	BOUTON	DRUCKKNOPF	BOTÓN
15	1730720005	SPIA VERDE PARTE AEREA GRANDE	BIG GREEN LIGHT AERIAL PART	VOYANT	KONTROLLLEUCHTE	INDICADOR
16	1692150001	BLOCCHETTO	BLOCK	BLOC	BLOCK	BLOQUE
17	1651290015	CHIAVE	KEY	CLÉ	SCHLÜSSEL	LLAVE
18	1773980004	PULSANTE	BUTTON	BOUTON	DRUCKKNOPF	BOTÓN
19	1772950019	SCATOLA ESCLUSIONE SICUREZZE COMPLETA TTC	BOX EXCLUSION SAFETY TTC	BOÎTE	GEHÄUSE	CAJA
20	1585570006	SELETTORE	SELECTOR	SÉLECTEUR	WÄHLSCHALTER	SELECTOR
21	17708000	INCLINOMETRO	INCLINOMETER	INCLINOMÈTRE	NEIGUNGSSENSOR	INCLINÓMETRO
22	05444800	MOLLA	SPRING	RESSORT	FEDER	MUELLE

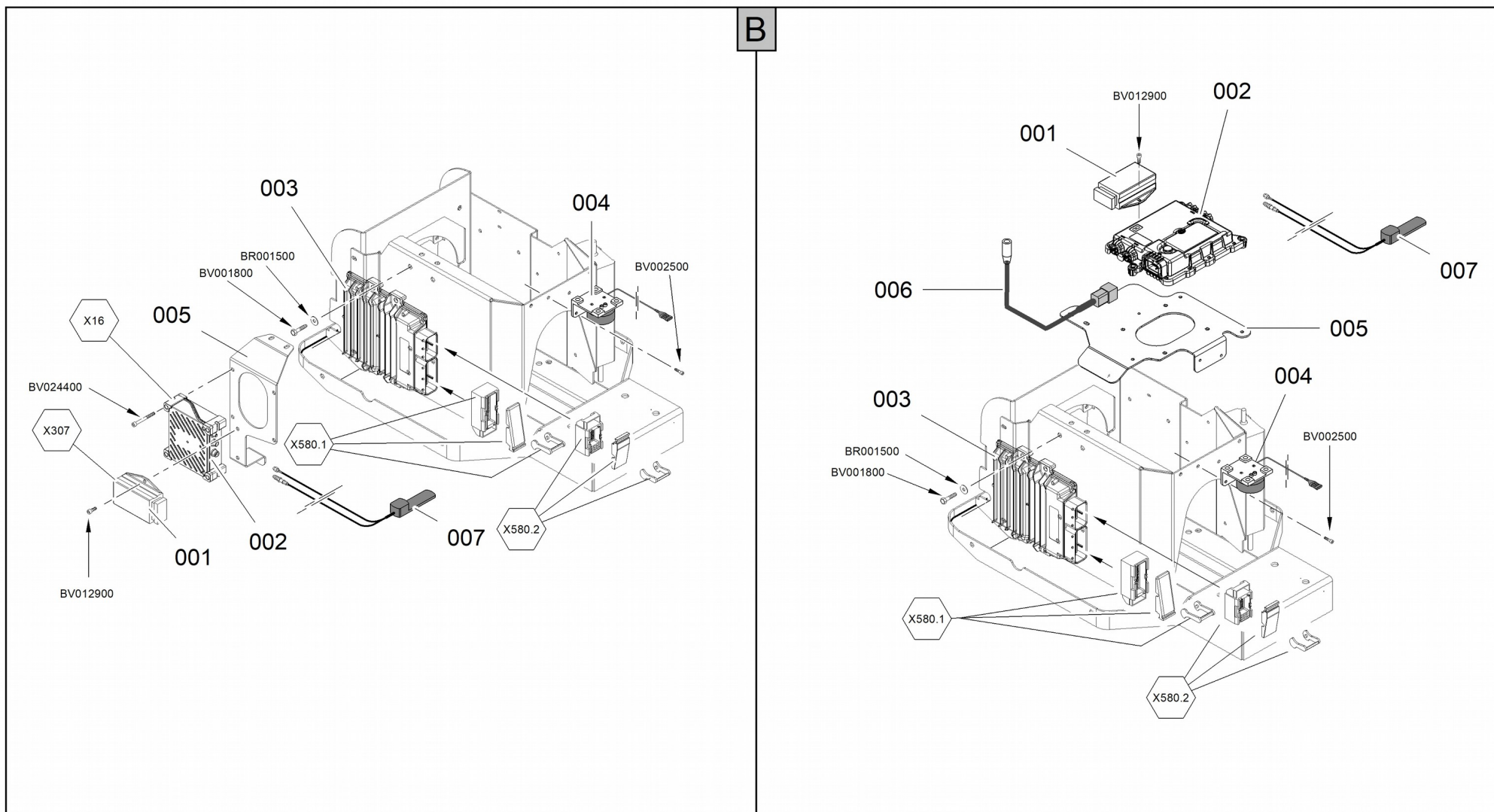

 Main color codes:  J1 - JLG Cream,  J2 - JLG Orange,  C4 - Green











 COMPONENTI IMPIANTO ELETTRICO



 ELECTRICAL SYSTEM COMPONENTS

 COMPOSANTS INSTALLATION ÉLECTRIQUE

 KOMponenten Elektroanlage 
 Componentes Instalación Eléctrica 



POS	Codice	 Descrizione	 Description	 Designation	 Benennung	 Descripción
1	1772950021	CENTRALINA 4 RELE' INDIPENDENTI 12V A TENUTA	CONTROL UNIT 4 RELAY 'INDEPENDENT 12V SEALED	UNITÉ DE CONTRÔLE	STEUERGERÄT	UNIDAD DE CONTROL
2	1772950017	MODEM ESTERNO GPS-4G CAN PROGRAMMATO PER GESTIONE A RICAMBIO	MODEM GPS-4G CAN TO SPARE	MODEM	MODEM	MODEM
2	1823120001	SCHEDA MODEM	MODEM BOARD	CARTE MODEM	PLATINE MODEM	PLACA MODEM
3	07844200	RESISTENZA 120 OHM PER CONNETTORE SERIALE RS-232	120 OHM RESISTANCE FOR CONNECTOR RS-232	120 OHM RESISTANCE POUR CONNECTEUR RS-232	120 OHM WIDERSTAND FÜR VERBINDER RS-232	RESISTENCIA 120 OHM PARA CONECTOR RS-232
3	17162400	KIT RAMHINO	RAMHINO KIT	KIT RAMHINO	KIT RAMHINO	KIT RAMHINO
3	17162500	CAVO RAMHINO SCHALTBAU	CAVO RAMHINO SCHALTBAU	CÂBLE	KABEL	CABLE
3	1787280015	SCHEDA MASTER X580 UNIVERSALE VERSIONE SOFTWARE INSTALLATO	MASTER BOARD X580 UNIVERSAL COMPATIBILITIES, SOFTWARE READY	CARTE ÉLECTRONIQUE	ELEKTRONISCHE PLATINE	TARJETA ELECTRÓNICA
3	26582800	ADATTATORE PCAN-USB (IPEH-002021)	ADAPTER	ADAPTEUR	ADAPTER	ADAPTADOR
4	06639100	AVVISATORE ACUSTICO	ACOUSTIC ALARM	BUZZER	SUMMER	ZUMBADOR
5	077739Y1	PIEGATO FISSAGGIO MODEM LL1570	BENT SECURING MODEM LL1570	SUPPORT	HALTERUNG	SOPORTE
5	082806Y1	STAFFA FISSAGGIO MODEM	MODEM FIXING BRACKET	SUPPORT MODEM	HALTERUNG MODEM	SOPORTE MODEM
6	18359800	PROLUNGA CONNESSIONE MODEM TTC WAVE	TTC WAVE MODEM CONNECTION EXTENSION	RALLONGE	VERLÄNGERUNG	ALARGADERA



 Main color codes:  J1 - JLG Cream,  J2 - JLG Orange,  C4 - Green

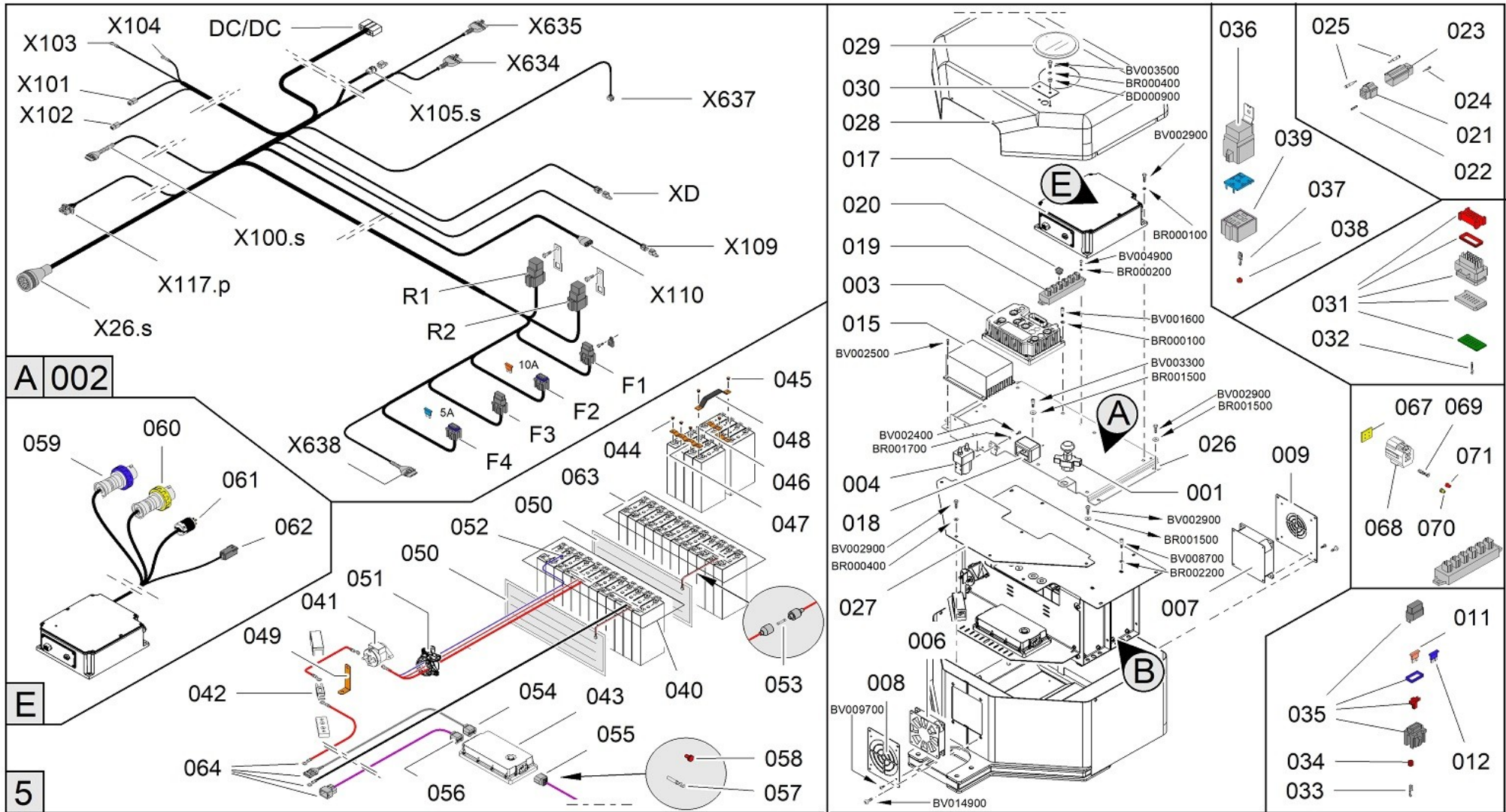



 COMPONENTI IMPIANTO ELETTRICO ELECTRICAL SYSTEM COMPONENTS COMPOSANTS INSTALLATION ÉLECTRIQUEKOMPONENTEN ELEKTROANLAGE 
COMPONENTES INSTALACIÓN ELÉCTRICA 



POS	Codice	 Descrizione	 Description	 Designation	 Benennung	 Descripción
7	28448200	ANTENNA 4G/LTE- 2G/3G+GPS/GLO L=150 CONNETTORI FAKRA PER MODEM TTC	AERIAL	LTE + GPS / GLO ANTENNA L = 150 FAKRA CONNECTORS FOR TTC MODEM	ANTENNE	ANTENA







 COMPONENTI IMPIANTO ELETTRICO LITIO
 ELECTRICAL SYSTEM COMPONENTS LITHIUM
 COMPOSANTS INSTALLATION ÉLECTRIQUE LITHIUM





KOMPONENTEN ELEKTROANLAGE LITHIUM 
 COMPONENTES INSTALACIÓN ELÉCTRICA LITHIUM 



POS	Codice	 Descrizione	 Description	 Designation	 Benennung	 Descripción
1	07827000	STACCABATTERIA A FUNGO 150A NOMINALI	BATTERY DISCONNECTERS 150A NOMINAL	COUPE-BATTERIE	BATTERIE-TRENNSCHALTER	DESCONECTADOR DE BATERÍA
2	17757200	KIT ELE INTEGRAZIONE LITHIUM LL1570-X15JP-X430AJ	INTEGRATION KIT ELECTRIC LITHIUM LL1570-X15JP-X430AJ	KIT ÉLECTRIQUE	ELEKTROSATZ	KIT ELÉCTRICO
2	1803220004	MRS RELÈ 12V S3 IMPULSO 2 SEC	MRS RELAY 12V S3 PULSE 2 SEC	MRS RELÉ 12V S3 IMPULSION 2 SEC	MRS RELAIS 12V S3 IMPULS 2 SEK	MRS RELÉ 12V S3 IMPULSO 2 SEC
3	26774600	INVERTER	INVERTER	INVERTER	INVERTER	INVERTER
5	18375100	IMPIANTO ELETTRICO E PACCO BATTERIE LITIO 36V 120AH COMPLETO MID	ELECTRICAL SYSTEM AND BATTERY PACK LITHIUM 36V 120AH COMPLETE MID	INSTALLATION ÉLECTRIQUE	ELEKTRISCHE ANLAGE	INSTALACIÓN ELÉCTRICA
5	27810200	IMPIANTO ELETTRICO E PACCO BATTERIE LITIO 36V 100AH COMPLETO MID	ELECTRICAL SYSTEM AND BATTERY PACK LITHIUM 36V 100AH COMPLETE MID	INSTALLATION ÉLECTRIQUE	ELEKTRISCHE ANLAGE	INSTALACIÓN ELÉCTRICA
6	1690690001	VENTOLA ANTERIORE	FRONT FAN	VENTILATEUR	LÜFTERRAD	VENTILADOR
7	1690690002	VENTOLA POSTERIORE	REAR FAN	VENTILATEUR	LÜFTERRAD	VENTILADOR
8	075692H2	PIASTRA FISSAGGIO VENTOLA	PLATE	PLAQUE	PLATTE	PLACA
9	067808H2	TAPPO VENTOLA POSTERIORE	CAP REAR FAN	BOUCHON	VERSCHLUSS	TAPÓN
11	05760700	FUSIBILE A LAMA 5A	FUSE 5A	FUSIBLE 5A	SICHERUNG 5A	FUSIBLE 5A
12	05760900	FUSIBILE 10A	FUSE 10A	FUSIBLE 10A	SICHERUNG 10A	FUSIBLE 10A
15	27032500	DC-DC IN36-72V OUT 12V16A VERSIONE LITHIUM CON TRATTAMENTO TRP	DC-DC IN36-72V OUT 12V16A LITHIUM VERSION WITH TRP TREATMENT	TRANSFORMATEUR	TRANSFORMATOR	TRANSFORMADOR



Main color codes:  J1 - JLG Cream,  J2 - JLG Orange,  C4 - Green

 COMPONENTI IMPIANTO ELETTRICO LITIO
 ELECTRICAL SYSTEM COMPONENTS LITHIUM
 COMPOSANTS INSTALLATION ÉLECTRIQUE LITHIUM



KOMPONENTEN ELEKTROANLAGE LITHIUM 
 COMPONENTES INSTALACIÓN ELÉCTRICA LITHIUM 



POS	Codice	 Descrizione	 Description	 Designation	 Benennung	 Descripción
17	17193200	CARICABATTERIE LITIO 48V-230V COMPLETO DI CABLAGGIO	LITHIUM BATTERY CHARGER 48V-230V COMPLETE WITH WIRING	CHARGEUR DE BATTERIE	LADEGERÄT	CARGADOR DE BATERÍA
17	17193300	CARICABATTERIE LITIO 48V-110/120V COMPLETO DI CABLAGGIO	LITHIUM BATTERY CHARGER 48V- 110/120V COMPLETE WITH WIRING	CHARGEUR DE BATTERIE	LADEGERÄT	CARGADOR DE BATERÍA
18	1730720088	ISOLATORE CONNESSIONE MASSA	INSULATOR EARTH CONNECTION	ISOLATEUR	ISOLATOR	AISLADOR
19	1730720087	CONNETTORE DERIVAZIONE CAN	JUNCTION CONNECTOR CAN	CONNECTEUR	VERBINDER	CONECTOR
20	1730720086	TAPPO CONNETTORE 2 VIE	CONNECTOR PLUG 2 WAY	BOUCHON CONNECTEUR	VERSCHLUSS VERBINDER	TAPA CONECTOR
20	1730720098	TAPPO PER CONNETTORE DERIVAZIONE CAN	CAP JUNCTION CONNECTOR CAN	CAP CONNECTEUR	CAP VERBINDER	CAP CONECTOR
21	1757250009	CONNETTORE PORTA FEMMINE 4 VIE MOLEX 220-110V 20- 25A	CONNECTOR	CONNECTEUR	VERBINDER	CONECTOR
22	1757250011	PUNTALINO	FERRULE	EMBOUT	ZWINGE	PUNTERA
23	1757250010	CONNETTORE PORTA MASCHI 4 VIE MOLEX 220-110V 20-25A	CONNECTOR	CONNECTEUR	VERBINDER	CONECTOR
24	1757250013	PUNTALINO MASCHIO PER CONNETTORE 4 VIE MOLEX 220-110V 20-25A	FERRULE	EMBOUT	ZWINGE	PUNTERA



 COMPONENTI IMPIANTO ELETTRICO LITIO
 ELECTRICAL SYSTEM COMPONENTS LITHIUM
 COMPOSANTS INSTALLATION ÉLECTRIQUE LITHIUM

KOMPONENTEN ELEKTROANLAGE LITHIUM 
 COMPONENTES INSTALACIÓN ELÉCTRICA LITHIUM 



POS	Codice	 Descrizione	 Description	 Designation	 Benennung	 Descripción
25	1757250012	TAPPO PER CHIUSURA FORI SU CONNETTORE 4 VIE MOLEX 220-110V 20-25A	CAP	BOUCHON	DECKEL	TAPA
26	178034D1	PIEGATO FISSAGGIO COMPONENTI PACCO LITIO LL1570-X15JP-X430AJ	COMPONENTS FIXING PACK LITHIUM LL1570-X15JP-X430AJ	SUPPORT	HALTERUNG	SOPORTE
27	178027D1	CARTER SUPERIORE CASSONE PACCO LITIO LL1570-X15JP-X430AJ	CARTER TOP LITHIUM LL1570-X15JP-X430AJ	CARTER	KUBELGEHÄUSE	CÁRTER
28	178035D1	COFANO SUPERIORE	COVER UPPER	COFFRE	MOTORHAUBE	CAPO
29	07377300	PROTEZIONE TRASPARENTE LED CARICABATTERIE PACCO LITIO 72V	TRANSPARENT PROTECTION CHARGER LED	PROTECTION TRANSPARENT	TRANSPARENT SCHUTZART	PROTECCIÓN TRANSPARENTE
30	178574D1	CHIUSURA FORI FISSAGGIO PER LAMPEGGIANTE SU PACCO LITIO	CLOSING FIXING HOLES FOR FLASHING ON PACK LITHIUM	FERMETURE	SCHLUSS	CIERRE
31	16774700	CONNETTORE AMP. AMPSEAL FE.35 VIE INVERTER 36-48 V	CONNECTOR AMP. AMPSEAL FE.35 VIE INVERTER 36-48 V	CONNECTEUR	VERBINDER	CONECTADOR
32	16774800	PUNTALINO FE05-1 MMQ AMPSEAL STAGNATO GL14.70 BATTERY	TERMINAL	BORNE	KLEMME	BORNE
33	1757260006	PUNTALINO PER PORTAFUSIBILE	FERRULE FOR FUSE HOLDER	BORNE	KLEMME	BORNE
34	1757260007	GOMMINO PER PORTAFUSIBILE	RUBBER FERRULE FOR FUSE HOLDER	INSERT CAOUTCHOUC	GUMMISATZ	INSERCIÓN DE GOMA
35	1757260001	PORTAFUSIBILE	FUSE HOLDER	PORTE-FUSIBLE	SICHERUNGSHALTER	PORTAFUSIBLE



Main color codes:  J1 - JLG Cream,  J2 - JLG Orange,  C4 - Green



 COMPONENTI IMPIANTO ELETTRICO LITIO
 ELECTRICAL SYSTEM COMPONENTS LITHIUM
 COMPOSANTS INSTALLATION ÉLECTRIQUE LITHIUM





KOMPONENTEN ELEKTROANLAGE LITHIUM 
 COMPONENTES INSTALACIÓN ELÉCTRICA LITHIUM 



POS	Codice	 Descrizione	 Description	 Designation	 Benennung	 Descripción
36	1776330003	RELE' MINI TYCO 12V PER CONNETTORE A TENUTA (MK2 DA C170000893)	RELAY 'MINI 12V TYCO CONNECTOR SEAL (MK2 FROM C170000893)	RELAIS	RELAIS	RELÉ
37	1776330007	PUNTALINI PER RELE' A TENUTA MINI TYCO 12V (MK2 DA C170000893)	FERRULE FOR RELAY SEAL MINI 12V TYCO (MK2 FROM C170000893)	BORNE	KLEMME	BORNE
38	1776330005	GOMMINO PER RELE' A TENUTA MINI TYCO 12V (MK2 DA C170000893)	RUBBER FOR RELAY SEAL MINI 12V TYCO (MK2 FROM C170000893)	JOINT RELÉ	GUMMIDICHTUNG	JUNTA DE GOMA
39	1776330004	PORTA RELE' A TENUTA PER MINI TYCO 12V (MK2 DA C170000893)	HOLDER RELAY SEAL FOR MINI 12V TYCO (MK2 FROM C170000893)	PORTE RELAIS	RELAISHALTER	PORTARELÉ
40	1779520002	MODULO CELLE LITIO MIDAC 19,2V 100AH CONFIG. "A" COMPLETO DI CONNESSIONE A CORREDO	MIDAC LITHIUM CELL MODULE 19,2V 100AH CONFIG. "A" COMPLETE WITH CONNECTION SUPPLIED	MODULE BATTERIE LITHIUM-ION	MODUL LITHIUM-IONEN-BATTERIE	MÓDULO BATERÍA LITIO
40	1837510002	MODULO CELLE LITIO MIDAC 19,2V 100AH CONFIG. "A" COMPLETO DI CONNESSIONE A CORREDO	MIDAC LITHIUM CELL MODULE 19,2V 100AH CONFIG. "A" COMPLETE WITH CONNECTION SUPPLIED	MODULE CELLULE LITHIUM MIDAC	LITHIUM-ZELLENMODUL MIDAC	MÓDULO CÉLULAS LITIO MIDAC
41	2781020012	TELERUTTORE DI POTENZA 500A	RELAY OF INTERNAL POWER PACK 500A	TELERUPTEUR 500A	FERNSCHALTER 500A	TELEINTERRUPTOR 500A
42	2781020014	FUSIBILE 400A	FUSE 400A	FUSIBLE	SICHERUNG	FUSIBLE
43	1837510001	BMS MASTER MID PROGRAMMATO PER 36V 100AH	BMS MASTER MID FOR 36V 100AH	BMS MASTER MID 36V 100AH	BMS MASTER MID 36V 100AH	BMS MASTER MID 36V 100AH



Main color codes:  J1 - JLG Cream,  J2 - JLG Orange,  C4 - Green



 COMPONENTI IMPIANTO ELETTRICO LITIO
 ELECTRICAL SYSTEM COMPONENTS LITHIUM
 COMPOSANTS INSTALLATION ÉLECTRIQUE LITHIUM





KOMPONENTEN ELEKTROANLAGE LITHIUM 
 COMPONENTES INSTALACIÓN ELÉCTRICA LITHIUM 



POS	Codice	 Descrizione	 Description	 Designation	 Benennung	 Descripción
43	2781020017	BMS MASTER MID PROGRAMMATO PER 36V 100AH	BMS MASTER MID FOR 36V 100AH	BMS MASTER MID 36V 100AH	BMS MASTER MID 36V 100AH	BMS MASTER MID 36V 100AH
44	2781020003	RIVETTO RAME H=10	COPPER RIVET H=10	RIVET	NIETE	REMACHE
45	2781020004	RIVETTO RAME H=12	COPPER RIVET H=12	RIVET	NIETE	REMACHE
46	2781020005	LAMA FISSAGGIO CELLE 2 FORI	PLATE FIXING CELLS 2 HOLES	PLAQUE DE FIXATION	MONTAGEPLATTE	PLACA DE FIJACION
47	2781020006	LAMA FISSAGGIO CELLE 4 FORI	PLATE FIXING CELLS 4 HOLES	PLAQUE DE FIXATION	MONTAGEPLATTE	PLACA DE FIJACION
48	2781020007	LAMA DI COLLEGAMENTO TRA MODULI	PLATE CONNECTION BETWEEN MODULES	PLAQUE DE CONEXION	VERBINDUNGSPLATTE	PLACA DE CONEXIÓN
49	2781020008	LAMA COLLEGAMENTO TELERUTTORE	PLATE CONNECTION RELAY	PLACA DE CONEXIÓN	VERBINDUNGSPLATTE	PLACA DE CONEXIÓN
50	2781020009	HEATER 36V 60W	HEATER 36V 60W	CHAUFFAGE 36V 60W	HEIZUNG 36V 60W	CALENTADOR 36V 60W
51	2781020011	SENSORE LEM PER LITIO MID	LEM SENSOR FOR LITHIUM MID	CAPTEUR	SENSOR	SENSOR
52	2781020013	SENSORE TEMPERATURA PACCO LITIO MID	TEMPERATURE SENSOR PACK LITHIUM MID	CAPTEUR	SENSOR	SENSOR
53	2781020015	FUSIBILE	FUSE	FUSIBLE	SICHERUNG	FUSIBLE
54	2781020019	CONNETTORE BMS 34 VIE FASATURA 1	CONNECTOR BMS 34 WAYS STEP 1	CONNECTEUR	VERBINDER	CONECTOR
55	2781020020	CONNETTORE BMS 34 VIE FASATURA 2	CONNECTOR BMS 34 WAYS STEP 2	CONNECTEUR	VERBINDER	CONECTOR
56	2781020021	CONNETTORE BMS 26 VIE	CONNECTOR BMS 26 WAYS	CONNECTEUR	VERBINDER	CONECTOR
57	2781020022	PIN PER CONNETTORI BMS 0,75-1,25	PIN CONNECTORS FOR BMS 0.75-1.25	BROCHE POUR CONNECTEURS	PIN-ANSCHLÜSSE	PIN PARA CONECTORES
58	2781020023	TAPPO PER CONNETTORI BMS	CAP FOR CONNECTORS BMS	COUVERCLE	DECKEL	TAPA



Main color codes:  J1 - JLG Cream,  J2 - JLG Orange,  C4 - Green

 COMPONENTI IMPIANTO ELETTRICO LITIO
 ELECTRICAL SYSTEM COMPONENTS LITHIUM
 COMPOSANTS INSTALLATION ÉLECTRIQUE LITHIUM





KOMPONENTEN ELEKTROANLAGE LITHIUM 
 COMPONENTES INSTALACIÓN ELÉCTRICA LITHIUM 

POS	Codice	 Descrizione	 Description	 Designation	 Benennung	 Descripción
59	1757250001	SPINA VOLANTE 230V 16A	FREE PLUG 230V 16A	FICHE	STECKER	ENCHUFE
60	1757250003	SPINA VOLANTE 110V 16A	FREE PLUG 110V 16A	CHEVILLE	STIF	CLAVIJA
61	27074000	TERMINAL PRESA USA A TERRA, CONN PLUG PART N°:4460138	TERMINAL GROUND SOCKET USA, CONN PLUG PART N °: 4460138	CONNECTEUR	VERBINDER	CONECTOR
62	1757250010	CONNETTORE PORTA MASCHI 4 VIE MOLEX 220-110V 20-25A	CONNECTOR	CONNECTEUR	VERBINDER	CONECTOR
62	1757250012	TAPPO PER CHIUSURA FORI SU CONNETTORE 4 VIE MOLEX 220-110V 20-25A	CAP	BOUCHON	DECKEL	TAPA
62	1757250013	PUNTALINO MASCHIO PER CONNETTORE 4 VIE MOLEX 220-110V 20-25A	FERRULE	EMBOUT	ZWINGE	PUNTERA
63	1779520003	MODULO CELLE LITIO MIDAC 19,2V 100AH CONFIG. "B" COMPLETO DI CONNESSIONE A CORREDO	MIDAC LITHIUM CELL MODULE 19,2V 100AH CONFIG. "B" COMPLETE WITH CONNECTION SUPPLIED	MODULE BATTERIE LITHIUM-ION	MODUL LITHIUM-IONEN-BATTERIE	MÓDULO BATERÍA LITIO
63	1837510003	MODULO CELLE LITIO MIDAC 19,2V 100AH CONFIG. "B" COMPLETO DI CONNESSIONE A CORREDO	MIDAC LITHIUM CELL MODULE 19,2V 100AH CONFIG. "B" COMPLETE WITH CONNECTION SUPPLIED	MODULE CELLULE LITHIUM MIDAC	LITHIUM-ZELLENMODUL MIDAC	MÓDULO CÉLULAS LITIO MIDAC



Main color codes:  J1 - JLG Cream,  J2 - JLG Orange,  C4 - Green

 COMPONENTI IMPIANTO ELETTRICO LITIO
 ELECTRICAL SYSTEM COMPONENTS LITHIUM
 COMPOSANTS INSTALLATION ÉLECTRIQUE LITHIUM



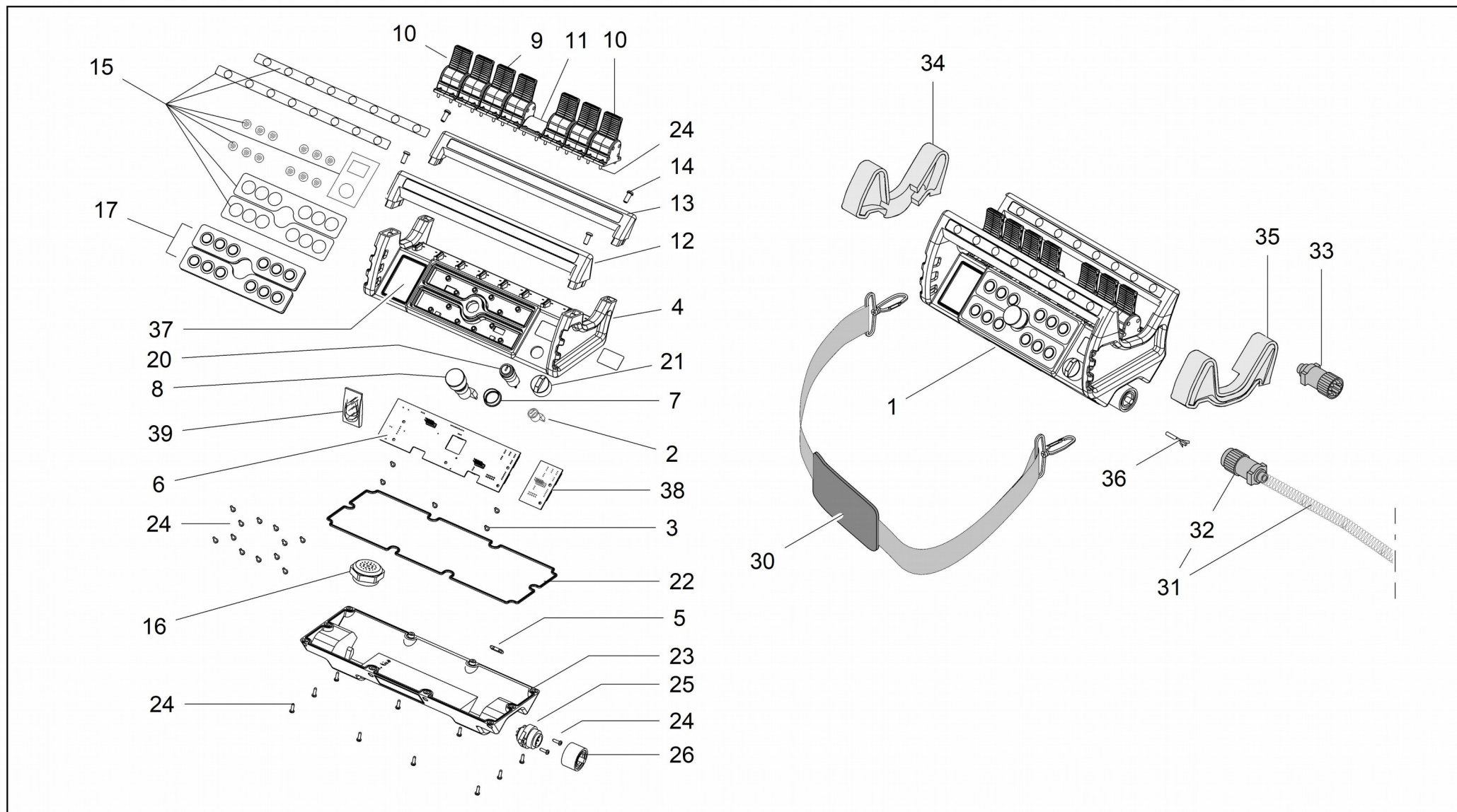

KOMPONENTEN ELEKTROANLAGE LITHIUM 
 COMPONENTES INSTALACIÓN ELÉCTRICA LITHIUM 



POS	Codice	 Descrizione	 Description	 Designation	 Benennung	 Descripción
64	2781020024	CABLAGGIO PER CONNESSIONI PACCO LITIO 36V 100AH (SPG0406)	WIRING FOR LITHIUM CONNECTIONS 36V 100AH (SPG0406)	CÂBLES	VERKABELUNG	CABLES
65	26429300	TELERUTTORE	POWER SWITCH RELAY	TÉLÉRUPTEUR	FERNSCHALTER	TELERUPTOR
67	1823960002	COVER CONNETTORE 4 VIE	COVER CONNECTOR	COVER CONNECTEUR	COVER VERBINDER	COVER CONECTADOR
68	1823960001	CONNETTORE 4 VIE	CONNECTOR	CONNECTEUR	VERBINDER	CONECTADOR
69	1739150027	PUNTALINO PER CONNETTORE PULSANTE CAVO 0,5-1	BUTTON CABLE CONNECTOR FERRULE 0.5-1	EMBOUT POUR BORNE BOUTON CÂBLE 0,5-1	VERSCHRAUBUNG	PUNTA PARA CONECTOR BOTÓN CABLE 0,5-1
70	1823960004	COVER CONNETTORE 4 VIE	RUBBER	CAOUTCHOUC POUR CONNECTEUR	GUMMISTÜCK FÜR STECKVERBINDER	GOMA PARA CONECTOR
71	1823960003	GOMMINO CHIUSO	CLOSED RUBBER	CAOUTCHOUC POUR CONNECTEUR	GUMMISTÜCK FÜR STECKVERBINDER	GOMA PARA CONECTOR





 TELECOMANDO
 REMOTE CONTROL
 TÉLÉCOMMANDE

FERNSTEUERUNG 
 TELECOMANDO 



POS	Codice	 Descrizione	 Description	 Designation	 Benennung	 Descripción
1	27237400	TELECOMANDO CASE GRIGIO	REMOTE CONTROL GREY CASE	TÉLÉCOMMANDE	FERNSTEUERUNG	TELECOMANDO
2	07359400	CONTATTO PER STOP EMERGENZA TELECOMANDO 3S	CONTACT FOR EMERGENCY STOP REMOTE CONTROL 3S	CONTACTE POUR ARRET D'URGENCE	KONTAKT FÜR NOTSTOP	CONTACTO PARA PARADA DE EMERGENCIA
3	2646170003	VITI SCHEDA ELETTRONICA	ELECTRONIC BOARD SCREWS	VIS	SCHRAUBEN	TORNILLOS
4	2723740001	COPERCHIO SUPERIORE TELECOMANDO CASE GRIGIO + DISPLAY E PULSANTI (PER RICAMBIO È NECESSARIO IL SN DEL TELECOMANDO)	TOP COVER REMOTE CONTROL CASE GREY + DISPLAY AND BUTTONS (AS SPARE IS COMPULSORY THE SN OF REMOTE CONTROL)	COUVERCLE	DECKEL	TAPA
4	2723740002	COPERCHIO SUPERIORE TELECOMANDO CASE GRIGIO SOLO COPERCHIO, SENZA COMPONENTI E SENZA DISPLAY	TOP COVER REMOTE CONTROL CASE GREY ONLY CASE, WITHOUT COMPONENTS AND DISPLAY	COUVERCLE	DECKEL	TAPA
5	07359500	CONTATTO REED INTERNO TELECOMANDO 3S	REED CONTACT INTERNAL REMOTE 3S	REED CONTACT INTÉRIEUR 3S DISTANCE	REEDKONTAKT INDOOR REMOTE 3S	CONTACTO REED 3S REMOTO DE INTERIOR
6	2646170002	SCHEDA ELETTRONICA PER TELECOMANDO	ELECTRONIC BOARD FOR REMOTE CONTROL	FICHE ÉLECTRIQUE	ELEKTRONISCHE PLATINE	PLACA ELECTRÓNICA
7	2646170007	ANELLO	RING	BAGUE	RING	ANILLO
8	2646170008	PULSANTE EMERGENZA	EMERGENCY BUTTON	BOUTON D'URGENCE	NOTSTOP KNOPF	PULSADOR DE EMERGENCIA
9	17550700	KIT PROTEZIONE IN GOMMA PER JOYSTICK NERA	PROTECTION KIT	PROTECTION KIT	GUMMISCHUTZ KIT	PROTECCIÓN DE GOMA



Main color codes:  J1 - JLG Cream,  J2 - JLG Orange,  C4 - Green

 TELECOMANDO
 REMOTE CONTROL
 TÉLÉCOMMANDE





FERNSTEUERUNG 
 TELECOMANDO 

POS	Codice	 Descrizione	 Description	 Designation	 Benennung	 Descripción
9	2646170009	LEVA NERA	LEVER BLACK	LEVIER	HEBEL	PALANCA
10	17550800	KIT PROTEZIONE IN GOMMA PER JOYSTICK ROSSA	PROTECTION	PROTECTION	GUMMISCHUTZ	PROTECCION DE GOMA
10	2646170010	LEVA ROSSA	LEVER RED	LEVIER	HEBEL	PALANCA
12	2646170012	IMPUGNATURA SUPERIORE	GRIP UPPER PART	POIGNÉE	GRIFF	EMPUÑADURA
13	2646170013	IMPUGNATURA INFERIORE	GRIP LOWER PART	POIGNÉE	GRIFF	EMPUÑADURA
14	2646170014	VITE	SCREW	VIS	SCHRAUBE	TORNILLO
15	27005200	KIT ADESIVI	DECALS KIT	KIT AUTOCOLLANTS	AUFKLEBERSATZ	KIT PEGATINAS
16	2646170027	CICALINO COMPLETO DI SCHEDA ELETTRONICA TELECOMANDO	BEEPER FOR REMOTE CONTROL	BUZZER	SUMMER	ZUMBADOR COMPLETO DE TARJETA ELECTRÓNICA TELEMANDO
17	2646170017	PULSANTI	BUTTONS	BOUTONS	DRUCKKNÖPFE	BOTONES
20	2683930001	INTERRUPTORE	SWITCH	INTERRUPTEUR	SCHALTER	INTERRUPTOR
21	2683930002	CHIAVE ACCENSIONE	IGNITION KEY	CLÉ DE DÉMARRAGE	ZÜNDSCHLÜSSEL	LLAVE DE ENCENDIDO
22	2646170022	GUARNIZIONE	GASKET	JOINT	DICHTUNG	GUARNICIÓN
23	2646170023	COPERCHIO INFERIORE	COVER LOWER PART	COUVERCLE	DECKEL	TAPA
24	2646170024	VITE	SCREW	VIS	SCHRAUBE	TORNILLO
25	2646170025	CONNETTORE	CONNECTOR	CONNECTEUR	VERBINGER	CONECTOR
26	2646170026	COPERCHIO CONNETTORE	COVER CONNECTOR	COUVERCLE	DECKEL	TAPA
30	2646170030	CINGHIA	BELT	COURROIE	RIEMEN	CORREA
31	17235800	CAVO TELECOMANDO COMPLETO IIIS /200	COMPLETE REMOTE CONTROL CABLE IIIS / 200	CÂBLE COMPLET TÉLÉCOMMANDE IIIS /200	FERNBEDIENUNGSKABEL KOMPLETT IIIS / 200	CABLE TELECOMANDO COMPLETO IIIS /200
32	2646170032	CONNETTORE COLLEGAMENTO TELECOMANDO	CONNECTOR FOR REMOTE CONTROL	CONNECTEUR	VERBINGER	CONECTOR



Main color codes:  J1 - JLG Cream,  J2 - JLG Orange,  C4 - Green



 TELECOMANDO
 REMOTE CONTROL
 TÉLÉCOMMANDE

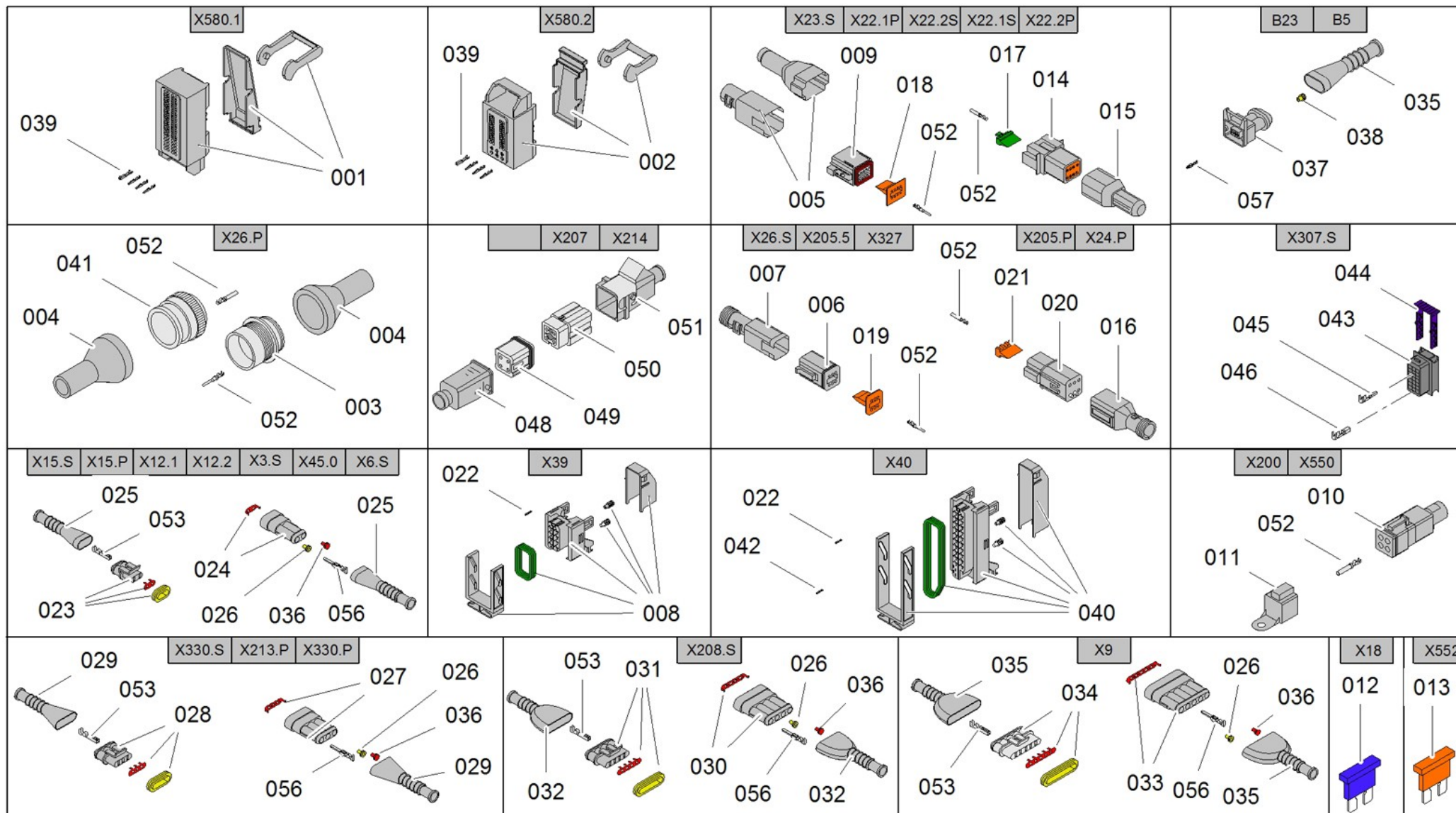



FERNSTEUERUNG 
 TELECOMANDO 



POS	Codice	 Descrizione	 Description	 Designation	 Benennung	 Descripción
33	08027200	DISPOSITIVO DI COMANDO PER ABILITAZIONE EMERGENZA A TERRA	CONTROL DEVICE FOR ACTIVATING THE EMERGENCY GROUND	DISPOSITIF DE COMMANDE EN CAS D'URGENCE	STEUERVORRICHTUNG IM NOTFALL	DISPOSITIVO DE CONTROL DE EMERGENCIA
33	1684540001	DISPOSITIVO DI COMANDO PER ABILITAZIONE EMERGENZA A TERRA	CONTROL DEVICE FOR ACTIVATING THE EMERGENCY GROUND	DISPOSITIF DE COMMANDE EN CAS D'URGENCE	STEUERVORRICHTUNG IM NOTFALL	DISPOSITIVO DE CONTROL DE EMERGENCIA
34	07027100	PROTEZIONE DESTRA	RIGHT PROTECTION	PROTECTION DROITS	ABDECKUNG RECHTS	PROTECCIÓN DERECHA
35	07027200	PROTEZIONE SINISTRA	LEFT PROTECTION	PROTECTION GAUCHE	ABDECKUNG LINKS	PROTECCIÓN IZQUIERDA
36	27283000	PUNTALINO FEMMINA PER CONNETTORE TELECOMANDO	TERMINAL FEMALE CONNECTOR FOR REMOTE CONTROL	CONNECTEUR FEMELLE	VERBINDUNG	CONECTOR
36	2728300001	PUNTALINO MASCHIO PER CONNETTORE TELECOMANDO	TERMINAL MALE CONNECTOR FOR REMOTE CONTROL	CONNECTEUR	VERBINDER	CONECTOR
37	07320200	SCHERMO LCD (PER RICAMBIO È NECESSARIO IL SN DEL TELECOMANDO)	DISPLAY (AS SPARE IS COMPULSORY THE SN OF REMOTE CONTROL)	ÉCRAN	DISPLAY	PANTALLA
38	2646170006	SCHEDA DI TENSIONE TELECOMANDO	POWER BOARD FOR REMOTE CONTROL	CARTE	PLATINE	PLACA
39	2646170036	KIT CABLAGGIO INTERNO TELECOMANDO	INTERNAL CABLE KIT FOR REMOTE CONTROL	KIT CÂBLES TELECOMMANDE	SATZ KABEL FERNBEDIENUNG	KIT CABLES TELEMANDO







 IMPIANTO ELETTRICO
 ELECTRICAL SYSTEM
 INSTALLATION ÉLECTRIQUE



ELEKTRISCHE ANLAGE 
 INSTALACIÓN ELÉCTRICA 



POS	Codice	 Descrizione	 Description	 Designation	 Benennung	 Descripción
1	1757250027	CAPPUCCIO POSTERIORE PER CONNETTORE 6 VIE FEMMINA	CAP	CAPUCHON	KAPPE	TAPA
1	1772950005	CONNETTORE X580.1	CONNECTOR X580.1	CONNECTEUR	VERBINDER	CONECTADOR
2	1772950006	CONNETTORE X580.2	CONNECTOR X580.2	CONNECTEUR	VERBINDER	CONECTADOR
3	1730720051	CONNETTORE 29 VIE M MOTORE (X26)	CONNECTOR	CONNECTEUR	VERBINDER	CONECTOR
4	1730720054	CAPPUCCIO POSTERIORE	CAP	CAPUCHON	KAPPE	CAPUCHO
5	1730720035	COVER POSTERIORE RIGIDA PER CONNETTORE 8 VIE MASCHIO	PROTECTION	PROTECTION	SCHUTZ	PROTECCION
5	1757250025	CAPPUCCIO POSTERIORE PER CONNETTORE MASCHIO	CAP	CAPUCHON	KAPPE	TAPA
6	1730720037	CONNETTORE 6 VIE MASCHIO	6-WAY MALE CONNECTOR	CONNECTEUR 6 VOIES MÂLE	6-WEGE-VERBINDER	CONECTOR 6 VÍAS
7	1730720039	COVER POSTERIORE RIGIDA PER CONNETTORE 6 VIE MASCHIO	PROTECTION	PROTECTION	SCHUTZ	PROTECCION
8	1772950009	CONNETTORE PER 48XS 28 POLI	CONNECTOR FOR 48XS 28P	CONNECTEUR	KLEMME	BORNE
9	1730720033	CONNETTORE 8 VIE MASCHIO	8-WAY MALE CONNECTOR	CONNECTEUR 8 VOIES MÂLE	8-WEGE-VERBINDER STIFT	CONECTOR 8 VÍAS MACHO
10	1763330001	CONNETTORE 4 VIE MASCHIO DEUTSCH	4-WAY MALE CONNECTOR DEUTSCH	CONNECTEUR 4 VOIES MÂLE DEUTSCH	4-WEGE-VERBINDER STIFT DEUTSCH	CONECTOR 4 VÍAS MACHO DEUTSCH



Main color codes:  J1 - JLG Cream,  J2 - JLG Orange,  C4 - Green



 IMPIANTO ELETTRICO
 ELECTRICAL SYSTEM
 INSTALLATION ÉLECTRIQUE





ELEKTRISCHE ANLAGE 
 INSTALACIÓN ELÉCTRICA 



POS	Codice	 Descrizione	 Description	 Designation	 Benennung	 Descripción
11	1763330002	CAPPUCCIO FRONTALE CONNETTORE 4 VIE MASCHIO DEUTSCH	CAP FOR 4-WAY MALE CONNECTOR DEUTSCH	PAC CONNECTEUR 4 VOIES MÂLE DEUTSCH	CAP 4-WEGE-VERBINDER STIFT DEUTSCH	CAP CONECTOR 4 VÍAS MACHO DEUTSCH
12	07700700	FUSIBILE A LAMA 25A	FUSE 25A	FUSIBLE 25A	SICHERUNG 25A	FUSIBLE 25A
13	05760700	FUSIBILE A LAMA 5A	FUSE 5A	FUSIBLE 5A	SICHERUNG 5A	FUSIBLE 5A
14	1730720029	CONNETTORE 8 VIE FEMMINA	8-WAY FEMALE CONNECTOR	CONNECTEUR 8 VOIES FEMELLE	8-WEGE-VERBINDER BUCHSE	CONECTOR 8 VÍAS HEMBRA
15	1730720031	COVER POSTERIORE RIGIDA PER CONNETTORE 8 VIE FEMMINA	PROTECTION	PROTECTION	SCHUTZ	PROTECCION
15	1757250026	CAPPUCCIO POSTERIORE PER CONNETTORE FEMMINA	CAP	CAPUCHON	KAPPE	TAPA
16	1730720084	COVER POSTERIORE RIGIDA PER CONNETTORE 6 VIE FEMMINA	PROTECTION	PROTECTION	SCHUTZ	PROTECCION
17	1730720030	PIASTRINA DI BLOCCAGGIO CONNETTORE 8 VIE FEMMINA	PLATE	PLAQUE	PLATTE	PLACA
18	1730720034	PIASTRINA DI BLOCCAGGIO CONNETTORE 8 VIE MASCHIO	PLATE	PLAQUE	PLATTE	PLACA
19	1730720038	PIASTRINA DI BLOCCAGGIO CONNETTORE 6 VIE MASCHIO	PLATE	PLAQUE	PLATTE	PLACA
20	1730720041	CONNETTORE 6 VIE FEMMINA	6-WAY FEMALE CONNECTOR	CONNECTEUR 6 VOIES FEMELLE	6-WEGE-VERBINDER BUCHSE	CONECTOR 6 VÍAS HEMBRA



Main color codes:  J1 - JLG Cream,  J2 - JLG Orange,  C4 - Green





 IMPIANTO ELETTRICO
 ELECTRICAL SYSTEM
 INSTALLATION ÉLECTRIQUE



ELEKTRISCHE ANLAGE 
 INSTALACIÓN ELÉCTRICA 



POS	Codice	 Descrizione	 Description	 Designation	 Benennung	 Descripción
21	1730720042	PIASTRA BLOCCAGGIO CONNETTORE 6 VIE FEMMINA	CONNECTOR	CONNECTEUR	VERBINDER	CONECTADOR
22	1772950007	PUNTALINO FEMMINA PER 48XS CAVO 0,5-1	FERRULE FEMALE 48XS 0,5-1	BORNE	KLEMME	BORNE
23	1757250031	CONNETTORE SUPERSEAL PF 2 VIE	CONNECTOR	CONNECTEUR	VERBINDER	CONECTADOR
24	1757250032	CONNETTORE SUPERSEAL PM 2 VIE	CONNECTOR	CONNECTEUR	VERBINDER	CONECTADOR
25	1757250033	CAPPUCCIO POSTERIOERE CONNETTORE SUPERSEAL 2 VIE	CAP	CAPUCHON	KAPPE	CAPUCHO
26	1757250043	GOMMINO TENUTA PER CAVI CONNETTORI SUPERSEAL	RUBBER SEAL	JOINT EN CAOUTCHOUC	GUMMIDICHTUNG	JUNTA DE GOMA
27	1757250035	CONNETTORE SUPERSEAL PM 3 VIE	CONNECTOR	CONNECTEUR	VERBINDER	CONECTADOR
28	1757250034	CONNETTORE SUPERSEAL PF 3 VIE	CONNECTOR	CONNECTEUR	VERBINDER	CONECTADOR
29	1757250036	CAPPUCCIO POSTERIOERE CONNETTORE SUPERSEAL 3 VIE	CAP	CAPUCHON	KAPPE	CAPUCHO
30	1757250038	CONNETTORE SUPERSEAL PM 4 VIE	CONNECTOR	CONNECTEUR	VERBINDER	CONECTADOR
31	1757250037	CONNETTORE SUPERSEAL PF 4 VIE	CONNECTOR	CONNECTEUR	VERBINDER	CONECTADOR



 IMPIANTO ELETTRICO
 ELECTRICAL SYSTEM
 INSTALLATION ÉLECTRIQUE





ELEKTRISCHE ANLAGE 
 INSTALACIÓN ELÉCTRICA 



POS	Codice	 Descrizione	 Description	 Designation	 Benennung	 Descripción
32	1757250039	CAPPUCCIO POSTERIORE CONNETTORE SUPERSEAL 4 VIE	CAP	CAPUCHON	KAPPE	CAPUCHO
33	1757250041	CONNETTORE SUPERSEAL PM 5 VIE	CONNECTOR	CONNECTEUR	VERBINDER	CONECTADOR
34	1757250040	CONNETTORE SUPERSEAL PF 5 VIE	CONNECTOR	CONNECTEUR	VERBINDER	CONECTADOR
34	1757250056	CONNETTORE SUPERSEAL PF 6 VIE	CONNECTOR	CONNECTEUR	VERBINDER	CONECTADOR
35	1757250042	CAPPUCCIO POSTERIOERE CONNETTORE SUPERSEAL 5 VIE	CAP	CAPUCHON	KAPPE	CAPUCHO
35	1757250057	CAPPUCCIO POSTERIOERE CONNETTORE SUPERSEAL 6-7 VIE	CAP	CAPUCHON	KAPPE	CAPUCHO
36	1757250046	GOMMINO TENUTA TAPPO PER CONNETTORI SUPERSEAL	RUBBER SEAL	JOINT EN CAOUTCHOUC	GUMMIDICHTUNG	JUNTA DE GOMA
37	1757250044	CONNETTORE JPT 2 VIE PER ELETTROVALVOLE	CONNECTOR	CONNECTEUR	VERBINDER	CONECTADOR
38	1757250045	GOMMINO TENUTA PER CAVI CONNETTORI JPT	RUBBER SEAL	JOINT EN CAOUTCHOUC	GUMMIDICHTUNG	JUNTA DE GOMA
39	1772950001	PUNTALINO FEMMINA PER X580 CAVO SEZ 0,75-1	FERRULE FEMALE X580 0,75-1	BORNE	KLEMME	BORNE
39	1772950002	PUNTALINO FEMMINA PER X580 CAVO SEZ 0,5	FERRULE FEMALE X580 0,5	BORNE	KLEMME	BORNE



Main color codes:  J1 - JLG Cream,  J2 - JLG Orange,  C4 - Green



 IMPIANTO ELETTRICO
 ELECTRICAL SYSTEM
 INSTALLATION ÉLECTRIQUE





ELEKTRISCHE ANLAGE 
 INSTALACIÓN ELÉCTRICA 



POS	Codice	 Descrizione	 Description	 Designation	 Benennung	 Descripción
39	1772950003	PUNTALINO FEMMINA PER X580 CAVO SEZ 1,5	FERRULE FEMALE X580 1,5	BORNE	KLEMME	BORNE
39	1772950004	PUNTALINO FEMMINA PER X580 CAVO SEZ 2,5	FERRULE FEMALE X580 2,5	BORNE	KLEMME	BORNE
40	1772950010	CONNETTORE PER 48XS 52 POLI	CONNECTOR FOR 48XS 52P	CONNECTEUR	VERBINDER	CONECTADOR
41	1730720059	CONNETTORE 29 VIE F MOTORE (X26)	CONNECTOR	CONNECTEUR	VERBINDER	CONECTADOR
42	1772950008	PUNTALINO FEMMINA PER 48XS CAVO 1,5	FERRULE FEMALE 48XS 1,5	BORNE	KLEMME	BORNE
43	17473600	PARTE DI CONNETTORE 24VIE	CONNECTOR PART 24 WAY	CONNECTEUR	VERBINDER	CONECTADOR
44	17473700	SLITTA PER CONNETTORE 24 VIE	SLIDE FOR 24-WAY CONNECTOR	COULISSEAU	SCHLITTEN	CORREDERA
45	17306300	PUNTALINO FEMMINA PER CONNETTORE 56 VIE SCHEDE MASTER D=1.5	FERRULE FEMALE CONNECTOR 56 WAY MAIN BOARD D = 1.5	BUTÉE FEMELLE CONNECTEUR 56 VOIES CARTE MASTER D = 1.5	AUFLAGESTIFT BUCHSE 56-WEGE-VERBINDER MASTERPLATINE D = 1.5	CONECTOR PUNTA HEMBRA 56 VÍAS TARJETA MASTER D=1,5
46	17473800	PUNTALINO FEMMINA PER CONNETTORE 24 VIE SCHEDE CELLA DI CARICO D=2.8	FERRULE FEMALE CONNECTOR 24 WAY BOARD LOAD CELL D = 2.8	EMBOUT FEMELLE POUR CONNECTEUR 24 VOIES CARTE CELLULE DE CHARGE D=2.8	VERSCHRAUBUNG BUCHSE FÜR 24-WEGE-VERBINDER KORBLAST-PLATINE D=2,8	PUNTAL HEMBRA PARA CONECTOR 24 VÍAS CELULA DE CARGA D=2.8
48	1730720083	CUSTODIA 3 POLI GRIGIA VOLANTE PER CONN.PM 4+1VIE 230/110V (X29)	HOUSING 3 POLE GREY FOR CONN. PM 4 + 1 WAY 230V / 110V (X29)	LOGEMENT	GEHÄUSE	ALOJAMIENTO
49	1730720082	FRUTTO CONN.PM 4+1VIE 230/110V (X29)	CONNECTOR PM 4 + 1 WAY 230V / 110V (X29)	CONNECTEUR	VERBINDER	CONECTADOR



Main color codes:  J1 - JLG Cream,  J2 - JLG Orange,  C4 - Green



 IMPIANTO ELETTRICO
 ELECTRICAL SYSTEM
 INSTALLATION ÉLECTRIQUE





ELEKTRISCHE ANLAGE 
 INSTALACIÓN ELÉCTRICA 



POS	Codice	 Descrizione	 Description	 Designation	 Benennung	 Descripción
50	1730720080	FRUTTO CONN. PF 4+1 VIA 230/110V (X29)	CONNECTOR PF 4 + 1 WAY 230V / 110V (X29)	CONNECTEUR	VERBINDER	CONECTADOR
51	1730720081	CUSTODIA 3 POLI GRIGIA CON GANCIO PER CONN. PF 4+1 VIA 230/110V (X29)	HOUSING 3 POLE GREY WITH HOOK FOR CONN. PF 4 + 1 ROUTE 230 / 110V (X29)	LOGEMENT	GEHÄUSE	ALOJAMIENTO
52	1730720032	TERMINALE MASCHIO CAVO 0.75-1.5	TERMINAL MALE CABLE 0.75-1.5	MALE TERMINAL	TERMINAL MALE	MALE TERMINAL
52	1730720036	TERMINALE FEMMINA CONNETTORE M CAVO 0.5-1	TERMINAL FEMALE MALE CONNECTOR CABLE 0.5-1	BORNE FEMELLE	TERMINAL FEMALE	TERMINAL HEMBRA
52	1730720040	TERMINALE FEMMINA (X24)	TERMINAL FEMALE (X24)	BORNE FEMELLE (X24)	TERMINAL FEMALE (X24)	TERMINAL HEMBRA (X24)
52	1730720043	TERMINALE MASCHIO (X24) DA 0.5 A 0.75	TERMINAL MALE (X24) DA 0.5 A 0.75	BORNE MALE (X24)	TERMINAL MALE (X24)	TERMINAL MACHO (X24)
52	1730720055	CONTATTO MASCHIO 25A CAVO 2.5-4	CONTACT MALE 25A CABLE 2.5-4	CONTACT MALE 25A	CONTACT MALE 25A	CONTACT MALE 25A
52	1730720056	TAPPO SIZE 12-16 (X26)	CAP SIZE 12-16 (X26)	CAP TAILLE 12-16 (X26)	CAP SIZE 12-16 (X26)	CAP TAMAÑO 12-16 (X26)
52	1730720057	TAPPO SIZE 16 (X26)	CAP SIZE 16 (X26)	PLUG SIZE 16 (X26)	PLUG SIZE 16 (X26)	MACHO TALLA 16 (X26)
52	1730720058	CONTATTO MASCHIO 7.5A (X26)	CONTACT PIN 7.5A (X26)	CONTACT PIN 7.5A (X26)	CONTACT PIN 7.5A (X26)	CONTACT 7.5A (X26)
52	1730720061	CONTATTO FEMMINA 7.5A (X26)	CONTACT FEMALE 7.5A (X26)	CONTACTER 7,5 FEMELLE (X26)	CONTACT FEMALE 7.5A (X26)	CONTACT 7.5A FEMENINO (X26)
52	1730720068	TAPPO SIZE 20 (X1)	CAP SIZE 20 (X1)	PLUG SIZE 20 (X1)	PLUG SIZE 20 (X1)	TAMAÑO DE ENCHUFE 20 (X1)



Main color codes:  J1 - JLG Cream,  J2 - JLG Orange,  C4 - Green

 IMPIANTO ELETTRICO
 ELECTRICAL SYSTEM
 INSTALLATION ÉLECTRIQUE



ELEKTRISCHE ANLAGE 
 INSTALACIÓN ELÉCTRICA 



POS	Codice	 Descrizione	 Description	 Designation	 Benennung	 Descripción
52	1730720069	CONTATTO FEMMINA 25A CONNETTORE M CAVO 2.5-4	CONTACT FEMALE 25A MALE CONNECTOR CABLE 2.5-4	CONTACT FEMELLE 25A	KONTAKT BUCHSE 25A	CONTACT HEMBRA 25A
53	1757250048	PUNTALINO FEMMINA PER SUPERSEAL	FERRULE FEMALE FOR SUPERSEAL	FERRULE	NUTMUTTER	ANILLO
56	1757250049	PUNTALINO MASCHIO PER SUPERSEAL	FERRULE MALE FOR SUPERSEAL	FERRULE	NUTMUTTER	ANILLO
57	1739150047	CONTATTO FEMMINA PER CONNETTORE JPT	CONTACT FEMALE FOR CONNECTOR JPT	CONTACT FEMELLE POUR CONNECTEUR JPT	KONTAKT BUCHSE FÜR JPT VERBINDER	CONTACTO HEMBRA PARA CONECTOR JPT

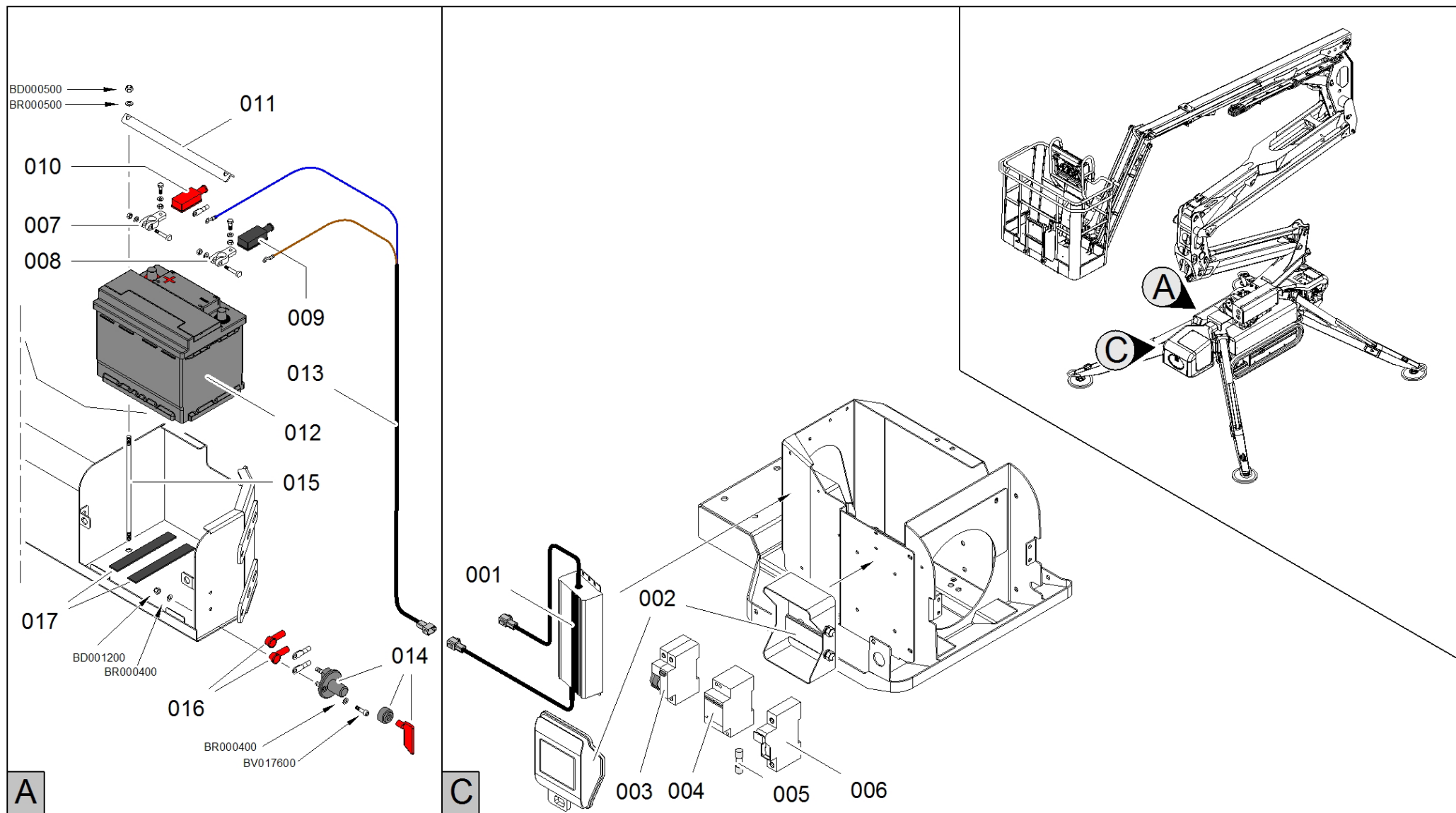

 IMPIANTO ELETTRICO
 ELECTRICAL SYSTEM
 INSTALLATION ÉLECTRIQUE





ELEKTRISCHE ANLAGE 
 INSTALACIÓN ELÉCTRICA 









Main color codes:  J1 - JLG Cream,  J2 - JLG Orange,  C4 - Green



 IMPIANTO ELETTRICO
 ELECTRICAL SYSTEM
 INSTALLATION ÉLECTRIQUE





ELEKTRISCHE ANLAGE 
 INSTALACIÓN ELÉCTRICA 

POS	Codice	 Descrizione	 Description	 Designation	 Benennung	 Descripción
1	1757250007	ALIMENTATORE ELETTRONICO 285W REGOLABILE IP65 PER BATTERIE 55-75 AH COMPLETO DI CONNETTORI	ELECTRONIC BALLAST	ALIMENTATEUR ÉLECTRONIQUE	ELEKTRONISCHES NETZGERÄT	ALIMENTADOR ELETRÓNICO
2	1757250008	SCATOLA ELETTRICO PLASTICA 6 MODULI BI COPERCHIO TRASPARENTE	ELECTRICAL BOX	BOÎTE ÉLECTRIQUE	SCHALTKASTEN	CAJA ELÉCTRICA
3	1556350063	INTERUTTORE AUTOMATICO MAGNETOTERMICO 110-120V 25A (FINO A C170000355 MONTATO C16 SU MACCHINE 120V)	AUTOMATIC THERMAL SWITCH 110-120V 25A (UNTIL C170000355 MOUNTED C16 ON 120V MACHINES)	INTERRUPTEUR	SCHALTER	INTERRUPTOR
4	1757250006	TELERUTTORE 4POLI 63A CA/CC	RELAY	RELAIS	RELAIS	RELÉ
5	1730720017	FUSIBILE A TUBO 10A	TUBE FUSE 10A	FUSIBLE	SICHERUNG	FUSIBLE
6	1730720015	PORTAFUSIBILE A TUBO 220/110V	FUSE HOLDER TUBE 220/110V	BOÎTE À FUSIBLES	SICHERUNGSKASTEN	PORTAFUSIBLES
7	1739150023	MORSETTO POSITIVO A C PER BATTERIA M10	POSITIVE BATTERY CLAMP "C" M10	BORNE POSITIVE A C POUR BATTERIE M10	POSITIVE KLEMME FÜR BATTERIE M10	BORNE POSITIVO A C PARA BATERÍA M10
8	1739150025	MORSETTO NEGATIVO A C PER BATTERIA M10	NEGATIVE BATTERY TERMINAL C M10	BORNE NEGATIVE A C POUR BATTERIE M10	NEGATIVE KLEMME FÜR BATTERIE M10	BORNE NEGATIVO A C PARA BATERÍA M10
9	2632920008	COPRI POLI BATTERIA QUADRATO NERO	POLE BATTERY COVER BLACK SQUARE	POLE BATTERIE COUVERTURE CARRÉ NOIR	POLE BATTERY COVER BLACK SQUARE	TAPAS BATERIA
10	2632920007	COPRI POLI BATTERIA QUADRATO ROSSO	POLE BATTERY COVER RED SQUARE	POLE CACHE BATTERIE RED SQUARE	POLE BATTERY COVER RED SQUARE	TAPAS DE LA BATERIA



Main color codes:  J1 - JLG Cream,  J2 - JLG Orange,  C4 - Green



 IMPIANTO ELETTRICO
 ELECTRICAL SYSTEM
 INSTALLATION ÉLECTRIQUE

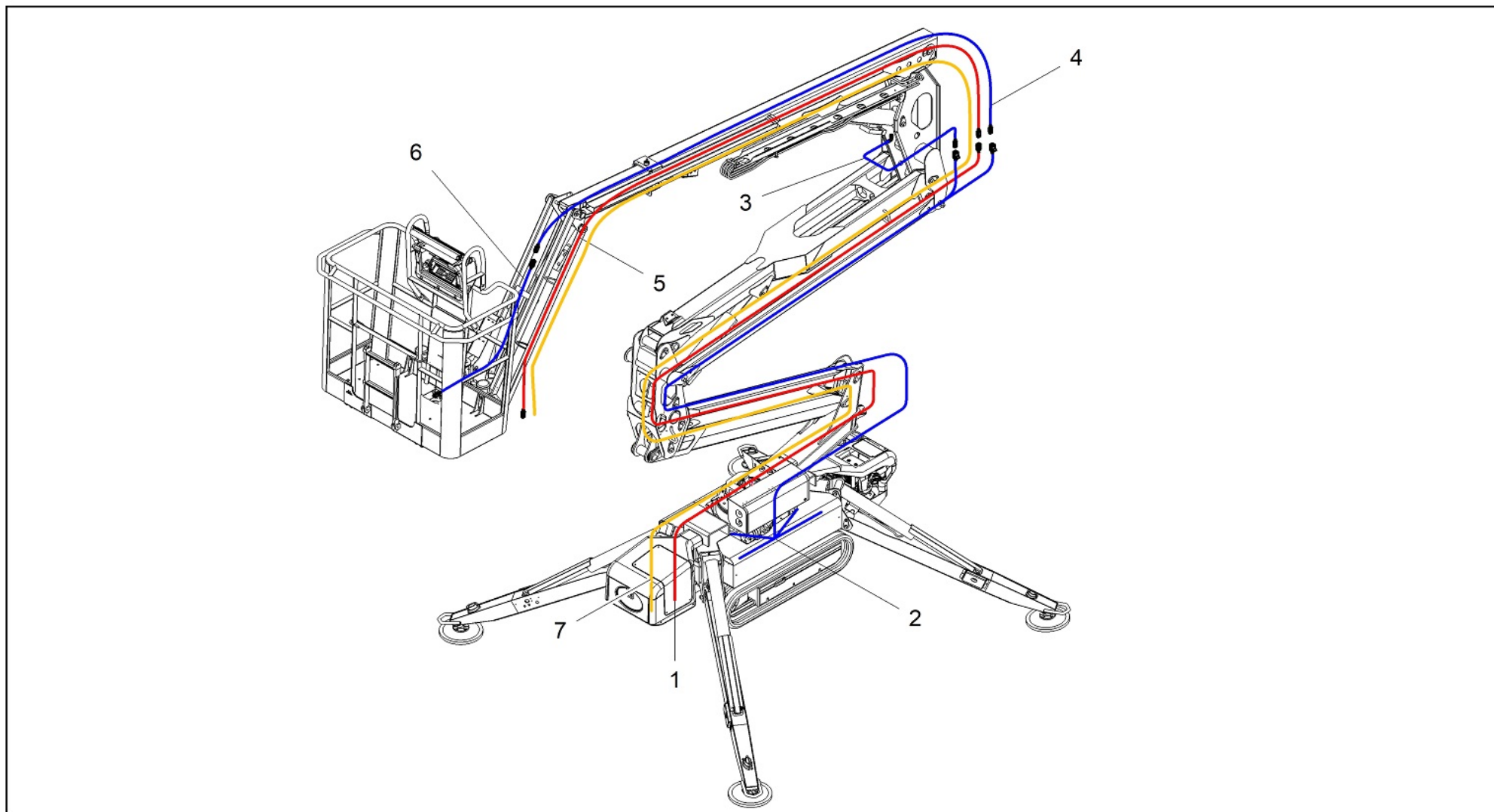

ELEKTRISCHE ANLAGE 
 INSTALACIÓN ELÉCTRICA 





POS	Codice	 Descrizione	 Description	 Designation	 Benennung	 Descripción
11	077483Y1	PIEGATO FISSAGGIO BATTERIA LL1570	BENT FIXING BATTERY LL1570	SUPPORT	HALTERUNG	SOPORTE
12	27668600	BATTERIA AGM S&S 12V 60AH 680A L02	BATTERY AGM S&S 12V 60AH 680A L02	BATTERIE AGM S&S 12V 60AH 680A L02	BATTERIE AGM S&S 12V 60AH 680A L02	BATERÍA AGM S&S 12V 60AH 680A L02
13	17572600081	CONNETTORE DEUTSCH 2 VIE COMPLETO DI DIODO CON PROTEZIONE	DEUTSCH CONNECTOR 2 WAYS OF COMPLETE WITH PROTECTION DIODE	CONNECTEUR	VERBINDER	CONECTOR
13	1772950020	LINEA DA ALIMENTATORE A BATTERIA COMPLETA DI CONNETTORI E DIODO LL1570-X15JP- X430AJ	LINE FROM CHARGER TO BATTERY WITH CONNECTORS AND DIODE LL1570-X15JP- X430AJ	LIGNE	LEITUNG	LÍNEA
14	04774900	STACCA BATTERIA	BATTERY CUT-OFF DEVICE	COUPE BATTERIE	BATTERIETRENNSCH ALTER	CORTA-BATERÍA
15	06551000	TIRANTE	TIE ROD	TIRANT	TURMGESTÄNGE	TIRANTE
16	1733730029	COPRIPOLO BATTERIA ROSSO GRANDE	BIG RED COVER FOR BATTERY POLE	PROTECTION PÔLE ROUGE GRAND	ROTE POLKAPPE BATTERIE	CUBREPOLO BATERÍA ROJO GRANDE









Main color codes:  J1 - JLG Cream,  J2 - JLG Orange,  C4 - Green



 IMPIANTO ELETTRICO
 ELECTRICAL SYSTEM
 INSTALLATION ÉLECTRIQUE

ELEKTRISCHE ANLAGE 
 INSTALACIÓN ELÉCTRICA 



POS	Codice	 Descrizione	 Description	 Designation	 Benennung	 Descripción
1	1772980001	CAVO PROLUNGA 220-110V DA BASE A PRIMO BRACCIO LL1570 TTC CONNETTORI SOURIAU	EXTENSION CABLE 220-110V FROM BASE TO FIRST BOOM LL1570 TTC CONNECTORS SOURIAU	CÂBLE	KABEL	CABLE
2	17729500	KIT ELETTRICO	ELECTRIC KIT	KIT COMPOSANTS ÉLECTRIQUES	SATZ ELEKTRISCHE BAUTEILE	KIT COMPONENTES ELÉCTRICOS
3	1730720094	CAVO COMPLETO PER SENSORE DI POSIZIONE 3 CILINDRO BRACCIO	CABLE ASSEMBLY FOR POSITION SENSOR 3 BOOM CYLINDER	CÂBLE COMPLET POUR CAPTEUR DE POSITION 3° CYLINDRE BRAS	KABEL KOMPLETT FÜR POSITIONSSENSOR 3. AUSLEGERARM- ZYLINDER	CABLE COMPLETO PARA SENSOR DE POSICIÓN 3ERO CILINDRO BRAZO
4	1772950014	CAVO PROLUNGA 7 POLI SFILO LL1570- X15JP-X430AJ	EXTENSION CABLE 7 WIRES EXTENSION BOOM LL1570-X15JP- X430AJ	CÂBLE	KABEL	CABLE
5	1772950013	CAVO PROLUNGA 220-110V SFILO LL1570-X15JP-X430AJ	EXTENSION CABLE 220V-110V EXTENSION BOOM LL1570-X15JP-X430AJ	CÂBLE	KABEL	CABLE
6	1772980002	KIT ELETTRICO JIB LL1570-X15JP-X430AJ TTC (0A055075)	ELECTRIC KIT JIB LL1570-X15JP-X430AJ TTC (0A055075)	CÂBLE	KABEL	CABLE



Main color codes:  J1 - JLG Cream,  J2 - JLG Orange,  C4 - Green



 ADESIVI
 STICKER
 AUTOCOLLANT





AUFKLEBER 
PEGATINA 



DECALS LIST



Main color codes:  **J1** - JLG Cream,  **J2** - JLG Orange,  **C4** - Green

 ADESIVI
 STICKER
 AUTOCOLLANT



AUFKLEBER 
 PEGATINA 



POS	Codice	 Descrizione	 Description	 Designation	 Benennung	 Descripción
0	06039600	ADESIVO	STICKER	AUTOCOLLANT	AUFKLEBER	PEGATINA
0	06039700	ADESIVO	STICKER	AUTOCOLLANT	AUFKLEBER	PEGATINA
0	06040100	ADESIVO	STICKER	AUTOCOLLANT	AUFKLEBER	PEGATINA
0	06040300	ADESIVO	STICKER	AUTOCOLLANT	AUFKLEBER	PEGATINA
0	06040500	ADESIVO	STICKER	AUTOCOLLANT	AUFKLEBER	PEGATINA
0	06040900	ADESIVO	STICKER	AUTOCOLLANT	AUFKLEBER	PEGATINA
0	06041200	ADESIVO	STICKER	AUTOCOLLANT	AUFKLEBER	PEGATINA
0	06041300	ADESIVO	STICKER	AUTOCOLLANT	AUFKLEBER	PEGATINA
0	06041600	ADESIVO CARBURANTE BENZINA COLORE VERDE L=60 X 80 (**)	DECAL	AUTOCOLLANT	AUFKLEBER	PEGATINA
0	06042400	ADESIVO	STICKER	AUTOCOLLANT	AUFKLEBER	PEGATINA
0	06043900	ADESIVO	STICKER	AUTOCOLLANT	AUFKLEBER	PEGATINA
0	06056300	ADESIVO	STICKER	AUTOCOLLANT	AUFKLEBER	PEGATINA
0	06060000	ADESIVO	STICKER	AUTOCOLLANT	AUFKLEBER	PEGATINA
0	06085900	ADESIVO	STICKER	AUTOCOLLANT	AUFKLEBER	PEGATINA
0	06086000	ADESIVO	STICKER	AUTOCOLLANT	AUFKLEBER	PEGATINA
0	06086700	ADESIVO	STICKER	AUTOCOLLANT	AUFKLEBER	PEGATINA
0	06136900	ADESIVO PUNTI INGRASSAGGIO Ø 55 TESTO NERO - SFONDO BIANCO (**)	STICKER GREASE POINTS Ø 55	AUTOCOLLANT POINTS GRAISSANGE Ø 55 TEXTE NOIR - FOND BLANC (**)	AUFKLEBER SCHMIERPUNKTE Ø 55, SCHWARZER TEXT - WEIßER UNTERGRUND	PEGATINS PUNTOS ENGRASE Ø 55 TEXTO NEGRO - FONDO BLANCO (**)
0	06164600	ADESIVO	STICKER	AUTOCOLLANT	AUFKLEBER	PEGATINA
0	06164700	ADESIVO	STICKER	AUTOCOLLANT	AUFKLEBER	PEGATINA
0	06165000	ADESIVO	STICKER	AUTOCOLLANT	AUFKLEBER	PEGATINA
0	06207700	ADESIVO	STICKER	AUTOCOLLANT	AUFKLEBER	PEGATINA
0	06227200	ADESIVO "CONTROLLARE LIVELLO OLIO MOTORE " 7 LINGUE GIALLO L=82X108 (**)	DECAL	AUTOCOLLANT	AUFKLEBER	PEGATINA



 ADESIVI
 STICKER
 AUTOCOLLANT

AUFKLEBER 
 PEGATINA 



POS	Codice	 Descrizione	 Description	 Designation	 Benennung	 Descripción
0	06232100	ADESIVO	STICKER	AUTOCOLLANT	AUFKLEBER	PEGATINA
0	06254800	ADESIVO" STOP EMERGENZA" SFONDO GIALLO L=100X50 (**)	DECAL	AUTOCOLLANT	AUFKLEBER	PEGATINA
0	06448100	ADESIVO	STICKER	AUTOCOLLANT	AUFKLEBER	PEGATINA
0	06448200	ADESIVO	STICKER	AUTOCOLLANT	AUFKLEBER	PEGATINA
0	06506400	ADESIVO	STICKER	AUTOCOLLANT	AUFKLEBER	PEGATINA
0	06520600	ADESIVO	STICKER	AUTOCOLLANT	AUFKLEBER	PEGATINA
0	06555500	ADESIVO	STICKER	AUTOCOLLANT	AUFKLEBER	PEGATINA
0	06555600	ADESIVO	STICKER	AUTOCOLLANT	AUFKLEBER	PEGATINA
0	06555700	ADESIVO	STICKER	AUTOCOLLANT	AUFKLEBER	PEGATINA
0	06555800	ADESIVO	STICKER	AUTOCOLLANT	AUFKLEBER	PEGATINA
0	06561200	ADESIVO	STICKER	AUTOCOLLANT	AUFKLEBER	PEGATINA
0	06706500	ADESIVO	STICKER	AUTOCOLLANT	AUFKLEBER	PEGATINA
0	06840400	ADESIVO	STICKER	AUTOCOLLANT	AUFKLEBER	PEGATINA
0	06922700	ADESIVO	STICKER	AUTOCOLLANT	AUFKLEBER	PEGATINA
0	06998800	ADESIVO	STICKER	AUTOCOLLANT	AUFKLEBER	PEGATINA
0	07034200	ADESIVO	STICKER	AUTOCOLLANT	AUFKLEBER	PEGATINA
0	07050700	ADESIVO	STICKER	AUTOCOLLANT	AUFKLEBER	PEGATINA
0	07056300	ADESIVO	STICKER	AUTOCOLLANT	AUFKLEBER	PEGATINA
0	07056400	ADESIVO	STICKER	AUTOCOLLANT	AUFKLEBER	PEGATINA
0	07056700	ADESIVO	STICKER	AUTOCOLLANT	AUFKLEBER	PEGATINA
0	07056800	ADESIVO	STICKER	AUTOCOLLANT	AUFKLEBER	PEGATINA
0	07058800	ADESIVO	STICKER	AUTOCOLLANT	AUFKLEBER	PEGATINA
0	07060500	ADESIVO	STICKER	AUTOCOLLANT	AUFKLEBER	PEGATINA
0	07060600	ADESIVO	STICKER	AUTOCOLLANT	AUFKLEBER	PEGATINA
0	07071000	ADESIVO	STICKER	AUTOCOLLANT	AUFKLEBER	PEGATINA
0	07071200	ADESIVO	STICKER	AUTOCOLLANT	AUFKLEBER	PEGATINA
0	07194400	ADESIVO	DECAL	AUTOCOLLANT	AUFKLEBER	PEGATINA
0	07240300	ADESIVO	STICKER	AUTOCOLLANT	AUFKLEBER	PEGATINA



Main color codes:  J1 - JLG Cream,  J2 - JLG Orange,  C4 - Green



 ADESIVI
 STICKER
 AUTOCOLLANT





AUFKLEBER 
 PEGATINA 



POS	Codice	 Descrizione	 Description	 Designation	 Benennung	 Descripción
0	07264700	ADESIVO INDICATORE LED CARICABATTERIE 48V (Ø EST.31MM Ø INT.6 MM) VECCHIO BMS (FINO A C170000329)	DECAL	AUTOCOLLANT	AUFKLEBER	PEGATINA
0	07264800	ADESIVO	DECAL	AUTOCOLLANT	AUFKLEBER	PEGATINA
0	07268300	ADESIVO	DECAL	AUTOCOLLANT	AUFKLEBER	PEGATINA
0	07268400	ADESIVO	DECAL	AUTOCOLLANT	AUFKLEBER	PEGATINA
0	07394800	ADESIVO INDICATORE LED CARICABATTERIE 48V (Ø EST.31MM Ø INT.6 MM) NUOVO BMS/4 (DA C170000330)	DECAL	AUTOCOLLANT	AUFKLEBER	PEGATINA
0	07499300	ADESIVO DON'T OPEN THE CASE SFONDO GIALLO L=60X17 MM	DECAL	AUTOCOLLANT	AUFKLEBER	PEGATINA
0	076358GB	ADESIVO	DECAL	AUTOCOLLANT	AUFKLEBER	PEGATINA
0	07668000	ADESIVO PERICOLO 110 VOLT 32A GIALLO	DECAL	AUTOCOLLANT	AUFKLEBER	PEGATINA
0	07668100	ADESIVO PULSANTI DISTRIBUTORE PARTE AEREA LL2614 L=318X52 MM	DECAL	AUTOCOLLANT	AUFKLEBER	PEGATINA
0	07668200	ADESIVO EMERGENCY STOP E BLOCCHETTO ACCENSIONE L=85X160 MM	DECAL	AUTOCOLLANT	AUFKLEBER	PEGATINA
0	07668300	ADESIVO	DECAL	AUTOCOLLANT	AUFKLEBER	PEGATINA
0	07669000	ADESIVO	DECAL	AUTOCOLLANT	AUFKLEBER	PEGATINA
0	07669100	ADESIVO	DECAL	AUTOCOLLANT	AUFKLEBER	PEGATINA
0	07676200	ADESIVO	DECAL	AUTOCOLLANT	AUFKLEBER	PEGATINA



Main color codes:  J1 - JLG Cream,  J2 - JLG Orange,  C4 - Green



 ADESIVI
 STICKER
 AUTOCOLLANT





AUFKLEBER 
 PEGATINA 

POS	Codice	 Descrizione	 Description	 Designation	 Benennung	 Descripción
0	07690100	ADESIVO	DECAL	AUTOCOLLANT	AUFKLEBER	PEGATINA
0	07691500	ADESIVO	DECAL	AUTOCOLLANT	AUFKLEBER	PEGATINA
0	07787800	ADESIVO	STICKER	AUTOCOLLANT	AUFKLEBER	PEGATINA
0	07788500	ADESIVO	DECAL	AUTOCOLLANT	AUFKLEBER	PEGATINA
0	07799200	ADESIVO	DECAL	AUTOCOLLANT	AUFKLEBER	PEGATINA
0	07799400	ADESIVO	DECAL	AUTOCOLLANT	AUFKLEBER	PEGATINA
0	07802200	ADESIVO RUMORE 102 DB L=90X100 MM	STICKER NOISE 102 DB L = 90 X 100 MM	AUTOCOLLANT	AUFKLEBER	PEGATINA
0	07808100	ADESIVO	DECAL	AUTOCOLLANT	AUFKLEBER	PEGATINA
0	07839500	ADESIVO	DECAL	AUTOCOLLANT	AUFKLEBER	PEGATINA
0	07878400	ADESIVO CASCO IMBRAGATURA E DIVIETI LL1370 L=175X118 MM	STICKER HELMET HARNESS AND BANS	AUTOCOLLANT CASQUE HARNAIS ET INTERDICTION	STICKER HELMGURT UND VERBOTE	ETIQUETA ARNÉS CASCO Y PROHIBICIONES
0	08069800	ADESIVO	STICKER	AUTOCOLLANT	AUFKLEBER	PEGATINA
0	08141300	ADESIVO	DECAL	AUTOCOLLANT	AUFKLEBER	PEGATINA
0	08318500	ADESIVO	DECAL	AUTOCOLLANT	AUFKLEBER	PEGATINA
0	08347400	STRISCIA BIANCA E ROSSA	DECAL	AUTOCOLLANT	AUFKLEBER	PEGATINA
0	08347500	STRISCIA BIANCA E ROSSA	DECAL	AUTOCOLLANT	AUFKLEBER	PEGATINA
0	1001125483	ADESIVO	STICKER	AUTOCOLLANT	AUFKLEBER	PEGATINA
0	1001223055	ADESIVO ISPEZIONE ANNUALE	DECAL YEARLY INSPECTION	INSPECTION ANNUELLE DES DÉCALQUES	AUFKLEBER JAHRESKONTROLLE	INSPECCIÓN ANUAL DE LA CALCOMANÍA
0	1001223453	ADESIVO NORMATIVA CANADESE ICES-002	CANADIAN REGULATIONS DECAL ICES-002	AUTOCOLLANT RÉGLEMENTAIRE CANADIEN ICES-002	KANADISCHE VORSCHRIFT AUFKLEBER	PEGATINA REGULATORIO CANADIENSE
0	1001228370	ADESIVO NORMATIVA CANADESE ICES-001	CANADIAN REGULATIONS DECAL ICES-001	AUTOCOLLANT RÉGLEMENTAIRE CANADIEN ICES-001	KANADISCHE VORSCHRIFTEN AUFKLEBER ICES-001	PEGATINA REGULATORIO CANADIENSE ICES- 001
0	1608710001	ADESIVO	STICKER	AUTOCOLLANT	AUFKLEBER	PEGATINA
0	1608710002	ADESIVO	STICKER	AUTOCOLLANT	AUFKLEBER	PEGATINA

Main color codes:  J1 - JLG Cream,  J2 - JLG Orange,  C4 - Green

 ADESIVI
 STICKER
 AUTOCOLLANT

AUFKLEBER 
 PEGATINA 

POS	Codice	 Descrizione	 Description	 Designation	 Benennung	 Descripcìon
0	1701504	ADESIVO	STICKER	AUTOCOLLANT	AUFKLEBER	PEGATINA
0	1701505	ADESIVO	STICKER	AUTOCOLLANT	AUFKLEBER	PEGATINA
0	1701640	ADESIVO	STICKER	AUTOCOLLANT	AUFKLEBER	PEGATINA
0	1701644	ADESIVO JLG CAVO CARICABATTERIA	STICKER JLG CABLE CHARGER	AUTOCOLLANT	AUFKLEBER	PEGATINA
0	1702155	ADESIVO	STICKER	AUTOCOLLANT	AUFKLEBER	PEGATINA
0	1703813	ADESIVO	STICKER	AUTOCOLLANT	AUFKLEBER	PEGATINA
0	1703814	ADESIVO	STICKER	AUTOCOLLANT	AUFKLEBER	PEGATINA
0	1704125	ADESIVO	DECAL	AUTOCOLLANT	AUFKLEBER	PEGATINA
0	1704277	ADESIVO	STICKER	AUTOCOLLANT	AUFKLEBER	PEGATINA
0	1705828	ADESIVO	STICKER	AUTOCOLLANT	AUFKLEBER	PEGATINA
0	1706098	ADESIVO	STICKER	AUTOCOLLANT	AUFKLEBER	PEGATINA
0	1706493	ADESIVO	STICKER	AUTOCOLLANT	AUFKLEBER	PEGATINA
0	1752770001	ADESIVO PER MACCHINE CON OLIO BIODEGRADABILE	STICKER FOR MACHINES WITH OIL BIODEGRADABLE	AUTOCOLLANT	AUFKLEBER	PEGATINA

Cod. 17107300

KIT INTEGRAZIONE ADESIVI PER PIATTAFORME AEREE LITHIUM-ANSI
INTEGRATION KIT STICKERS PLATFORMS LITHIUM-ANSI

X370AJ • X390AJ • X430AJ • X500AJ • X550AJ • X600AJ • X700AJ • X770AJ

Da usare in aggiunta ai seguenti kit di sicurezza /
To use in addition to the following safety kit

X370AJcod.17788300
X390AJcod.17065200
X430AJ.....cod.17788300
X500AJ / MK2.....cod. 17776800
X550AJ.....cod. 17065300
X600AJ / MK2.....cod. 17777000
X700AJ.....cod. 17065400
X770AJ.....cod. 17633600

+ kit in lingua non inclusi nel codice generale / language code not included in the standard kit

+171073GB + 171073FR + 171073ES + 171073PT

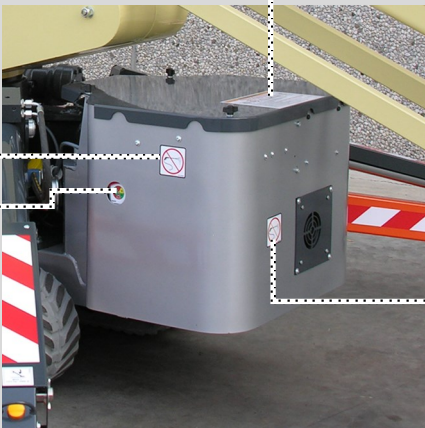

KIT ADESIVI - X390AJ

SET OF DECALS - X390AJ

KIT COLLANTS - X390AJ

AUFKLEBERSATZ - X390AJ

KIT ADHESIVOS - X390AJ

ADHESIEKIT - X390AJ

cod. 17107300

Tav 01

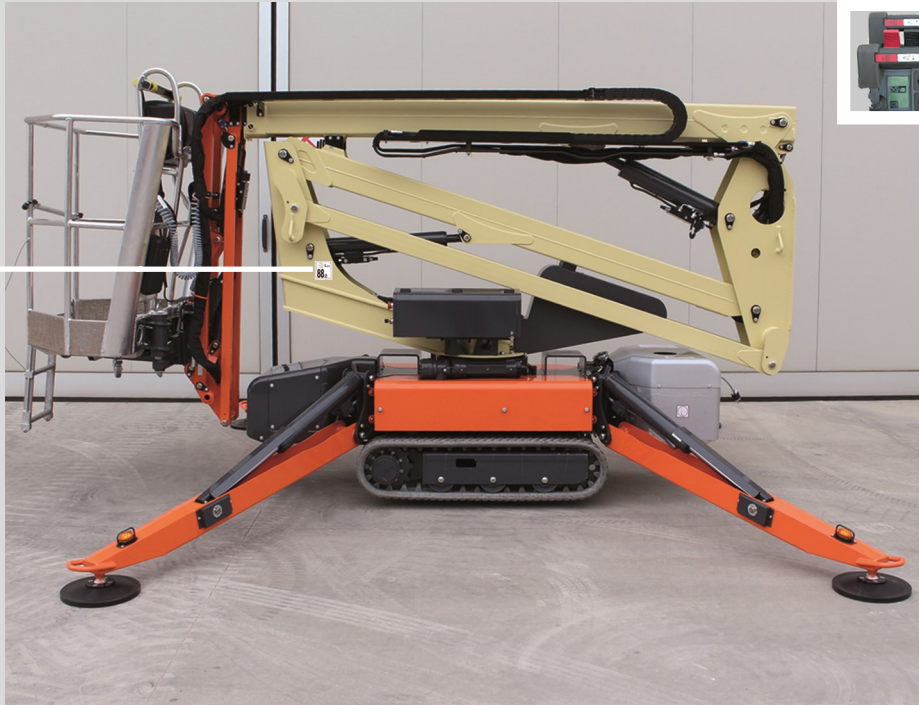

3

11

3

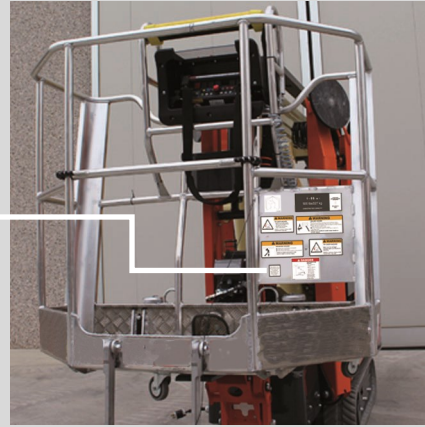
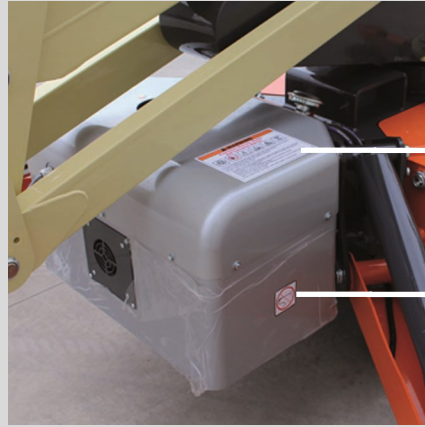
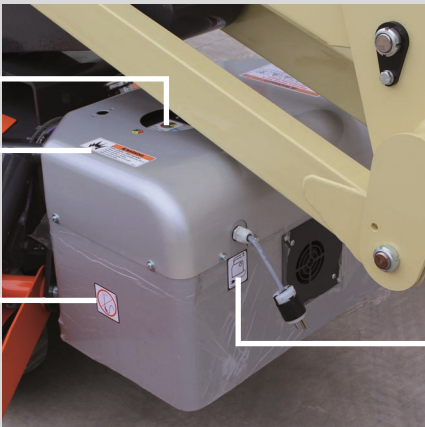

4

7

1

6

8

9

2

10

KIT ADESIVI - X370AJ / X430AJ

SET OF DECALS - X370AJ / X430AJ

KIT COLLANTS - X370AJ / X430AJ

AUFKLEBERSATZ - X370AJ / X430AJ

KIT ADHESIVOS - X370AJ / X430AJ

ADHESIEKIT - X370AJ / X430AJ

cod. 17107300

Tav 01



3

11

3

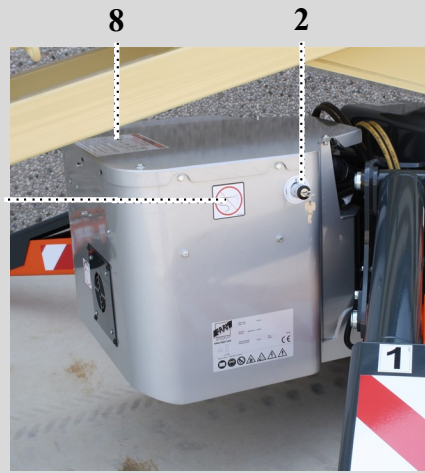
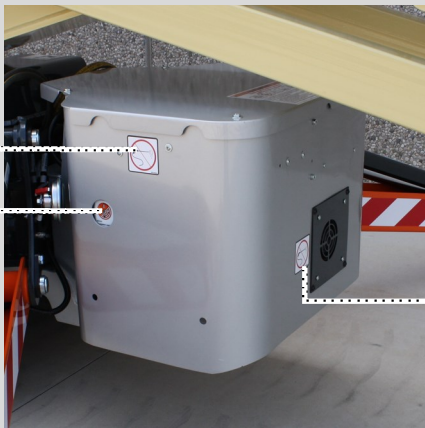

1

4

1

8

2

1

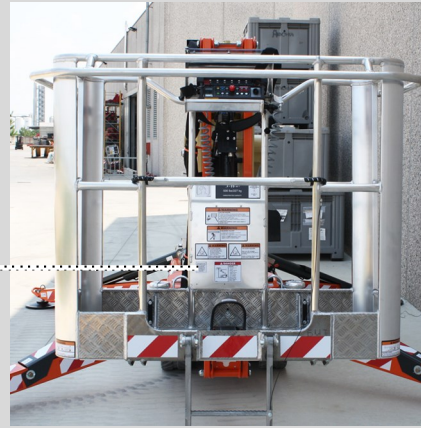

9

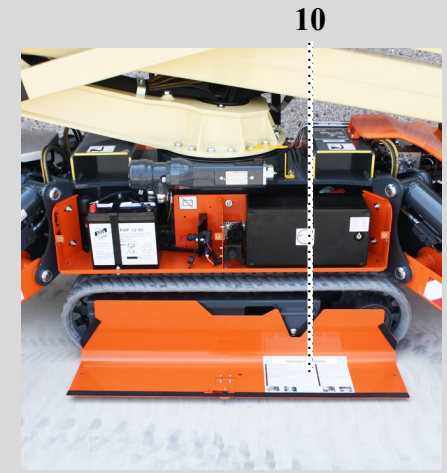

10

KIT ADESIVI - X500AJ

SET OF DECALS - X500AJ

KIT COLLANTS - X500AJ

AUFKLEBERSATZ - X500AJ

KIT ADHESIVOS - X500AJ

ADHESIEKIT - X500AJ

cod. 17107300

Tav 01



3

Sotto il coperchio /
under the cover



11



3

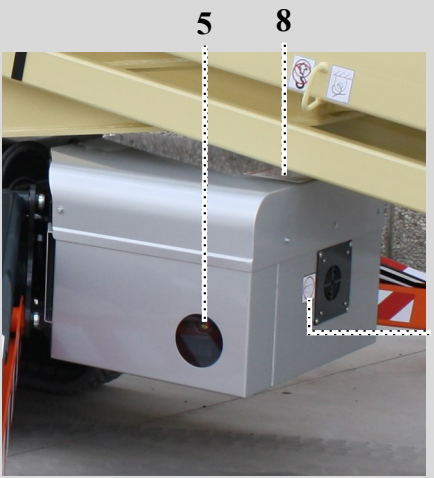

5

8

1



2

1

1



9



10

KIT ADESIVI - X600AJ

SET OF DECALS - X600AJ

KIT COLLANTS - X600AJ

AUFKLEBERSATZ - X600AJ

KIT ADHESIVOS - X600AJ

ADHESIEKIT - X600AJ

cod. 17107300

Tav 01



11

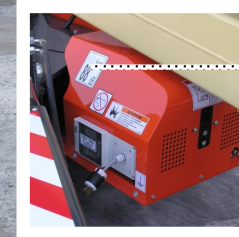

Sotto il coperchio /
under the cover

3

3



8



2

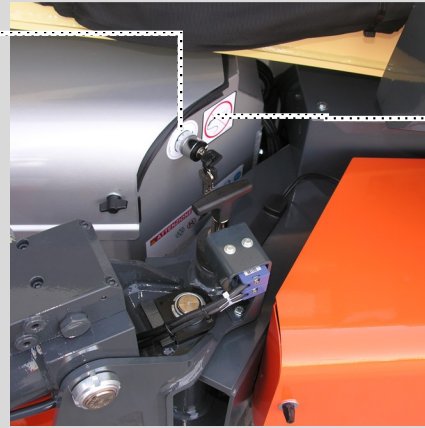

1

9

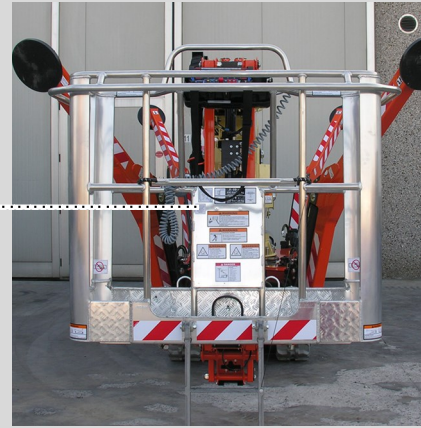

5 5 1

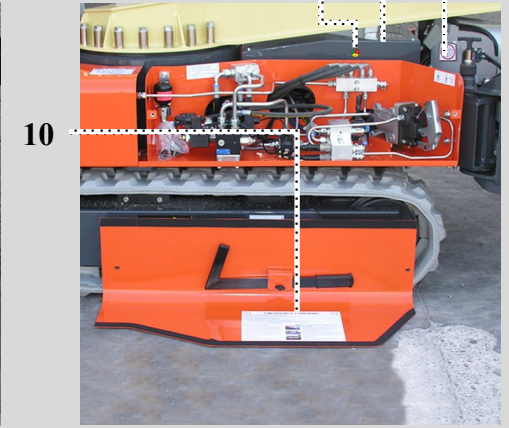

10

KIT ADESIVI - X700AJ

SET OF DECALS - X700AJ

KIT COLLANTS - X700AJ

AUFKLEBERSATZ - X700AJ

KIT ADHESIVOS - X700AJ

ADHESIEKIT - X700AJ

cod. 17107300

Tav 01



Sotto il coperchio /
under the cover

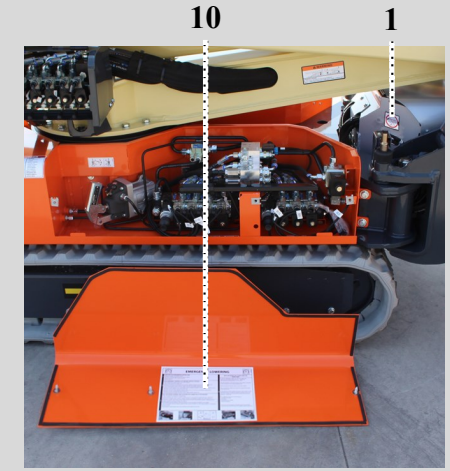
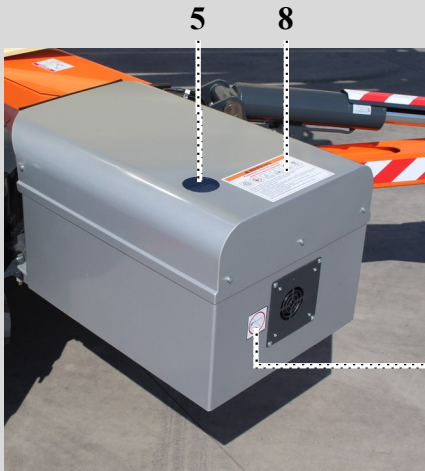

KIT ADESIVI - X770AJ

SET OF DECALS - X770AJ

KIT COLLANTS - X770AJ

AUFKLEBERSATZ - X770AJ

KIT ADHESIVOS - X770AJ

ADHESIEKIT - X770AJ

cod. 17107300

Tav 01

POS.	COD.	DESCRIZIONE / DESCRIPTION	Q.tà
01	1001125483	ADESIVO JLG VIETATO LAVARE L=63,5X63,5 MM	03
02	06506400	ADESIVO " CHIAVE DI ACCENSIONE" ESTERNO Ø 49 FORO Ø 22 SERIE LITHIUM ION _MOD_B (**)	01
03	06520600	ADESIVO RUMORE 88 dB L=90x100 MM _MOD_B (**)	02
04	07264700	ADESIVO INDICATORE LED CARICABATTERIE 48V (Ø EST.31MM Ø INT.6 MM) VECCHIO BMS (FINO A C170000329)	01
	07394800	ADESIVO INDICATORE LED CARICABATTERIE 48V (Ø EST.31MM Ø INT.6 MM) NUOVO BMS/4 (DA C170000330)	01
05	07264800	ADESIVO INDICATORE LED RICARICA BATTERIE Ø EST.21MM Ø INT.4 MM	02
06	1701644	ADESIVO JLG CAVO CARICABATTERIA L: 50,8X63,5 MM	01
07	1703813	ADESIVO JLG PERICOLO ESPLOSIONE BATTERIE - ING L=149,25X47,62 MM	01
08			
09			
10			
11	07194400	ADESIVO BOLLINO PER TELECOMANDO SERE IIIS COLORE GRIGIO Ø 10,50 MM	03
12			
13			
14			
15			
16			
17			
18			
19			
20			
21			

Cod. 17187700

KIT INTEGRAZIONE ADESIVI PER PIATTAFORME AEREE LITHIUM-CE /
INTEGRATION KIT STICKERS PLATFORMS LITHIUM-CE

X14J - X17J - X19J - X23J

X13JPLUS - X15JPLUS - X17JPLUS - X20JPLUS - X26JPLUS

Da usare in aggiunta a / To use in added to

X14J - cod.17063500

X14J-H - cod.17065000

X17J cod.17063700

X19J cod.17063200

X23J cod.17062700

X13JPLUS cod. 17788100

X15JPLUS cod. 17788100

X17JPLUS cod. 17242800

X20JPLUS cod. 17351800

X26JPLUS cod. 17633400

+ kit in lingua non inclusi nel codice generale + language code not included in the standard kit

171877IT / 171877GB / 171877FR / 171877DE / 171877ES / 171877NL / 171877SW / 171877PT /
171877DA / 171877NO / 171877RU / 171877PL / 171877SL / 171877FI / 171877CE / 171877JA



KIT ADESIVI X14J LITHIUM
 SET OF DECALS X14J LITHIUM
 KIT COLLANTS X14J LITHIUM

AUFKLEBERSATZ X14J LITHIUM
 KIT ADHESIVOS X14J LITHIUM
 ADHESIEKIT X14J LITHIUM

cod. 17187700

Tav 01



9



8



1
4

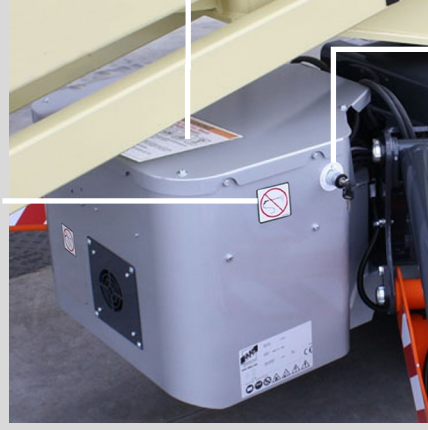

1
1

2



7



3

KIT ADESIVI X17J LITHIUM

SET OF DECALS X17J LITHIUM

KIT COLLANTS X17J LITHIUM

AUFKLEBERSATZ X17J LITHIUM

KIT ADHESIVOS X17J LITHIUM

ADHESIEKIT X17J LITHIUM

cod. 17187700

Tav 01



9

3

3

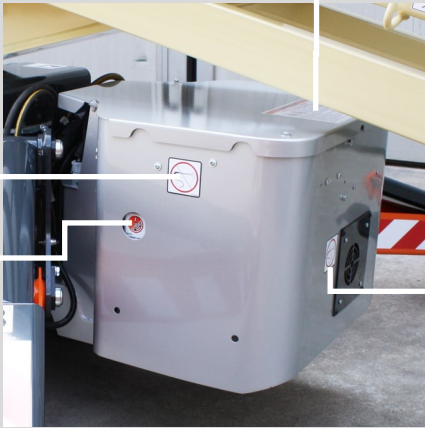

6

1

4



1

1

2



7



8

KIT ADESIVI X19J LITHIUM

SET OF DECALS X19J LITHIUM

KIT COLLANTS X19J LITHIUM

AUFKLEBERSATZ X19J LITHIUM

KIT ADHESIVOS X19J LITHIUM

ADHESIEKIT X19J LITHIUM

cod. 17187700

Tav 01

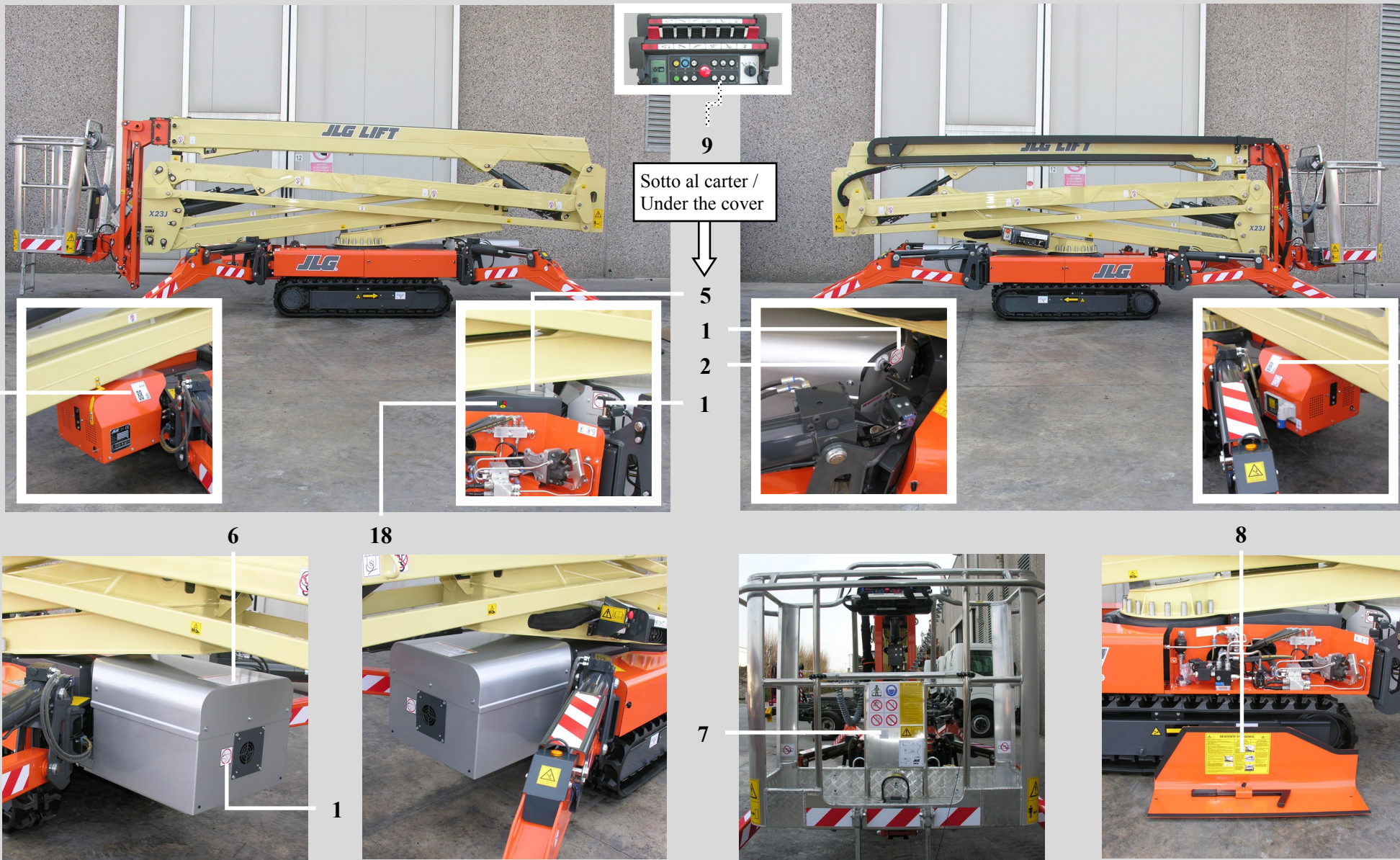

KIT ADESIVI X23J LITHIUM

SET OF DECALS X23J LITHIUM

KIT COLLANTS X23J LITHIUM

AUFKLEBERSATZ X23J LITHIUM

KIT ADHESIVOS X23J LITHIUM

ADHESIEKIT X23J LITHIUM

cod. 17187700

Tav 01



9



3

3



4

1



1

6

7

1



8

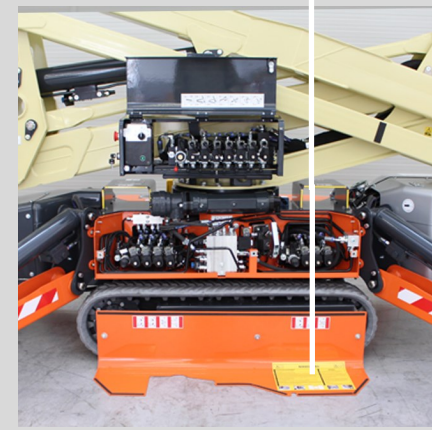

KIT ADESIVI - X13JPLUS LITHIUM
 SET OF DECALS - X13JPLUS LITHIUM
 KIT COLLANTS - X13JPLUS LITHIUM

AUFKLEBERSATZ X - X13JPLUS LITHIUM
 KIT ADHESIVOS - X13JPLUS LITHIUM
 ADHESIEKIT - X13JPLUS LITHIUM

cod. 17187700

Tav 01

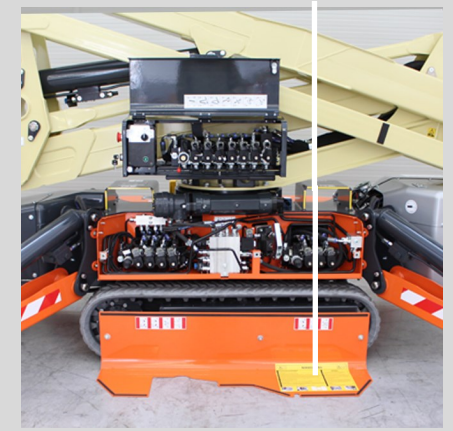

KIT ADESIVI - X15JPLUS LITHIUM
 SET OF DECALS - X15JPLUS LITHIUM
 KIT COLLANTS - X15JPLUS LITHIUM

AUFKLEBERSATZ X - X15JPLUS LITHIUM
 KIT ADHESIVOS - X15JPLUS LITHIUM
 ADHESIEKIT - X15JPLUS LITHIUM

cod. 17187700

Tav 01

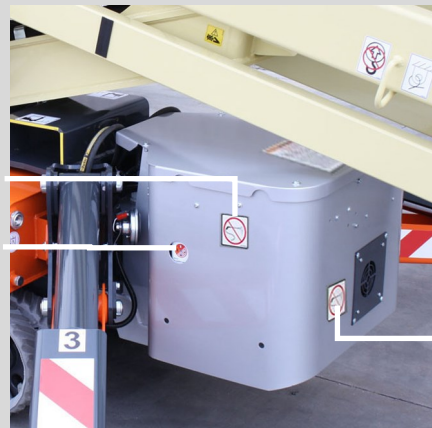

KIT ADESIVI X17JPLUS LITHIUM

SET OF DECALS X17JPLUS LITHIUM

KIT COLLANTS X17JPLUS LITHIUM

AUFKLEBERSATZ X17JPLUS LITHIUM

KIT ADHESIVOS X17JPLUS LITHIUM

ADHESIEKIT X17JPLUS LITHIUM

cod. 17187700

Tav 01



9

6



1

5

1



2

1

1

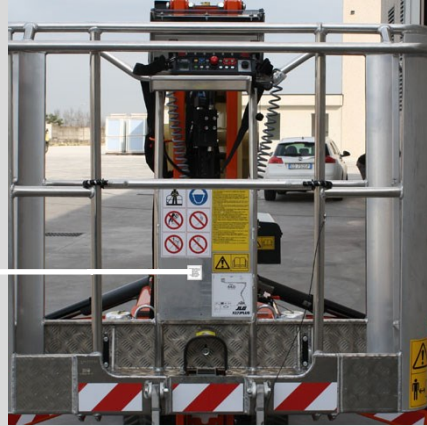

7

8



KIT ADESIVI X20JPLUS LITHIUM

SET OF DECALS X20JPLUS LITHIUM

KIT COLLANTS X20JPLUS LITHIUM

AUFKLEBERSATZ X20JPLUS LITHIUM

KIT ADHESIVOS X20JPLUS LITHIUM

ADHESIEKIT X20JPLUS LITHIUM

cod. 17187700

Tav 01

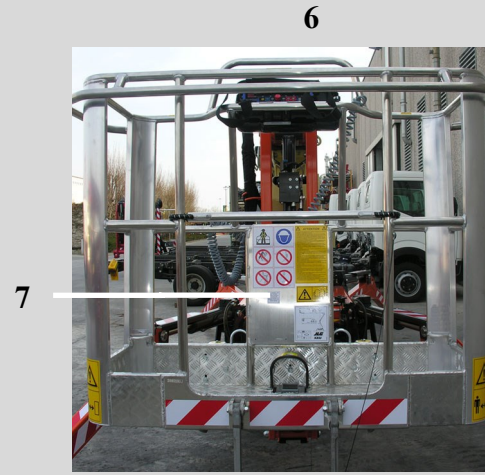
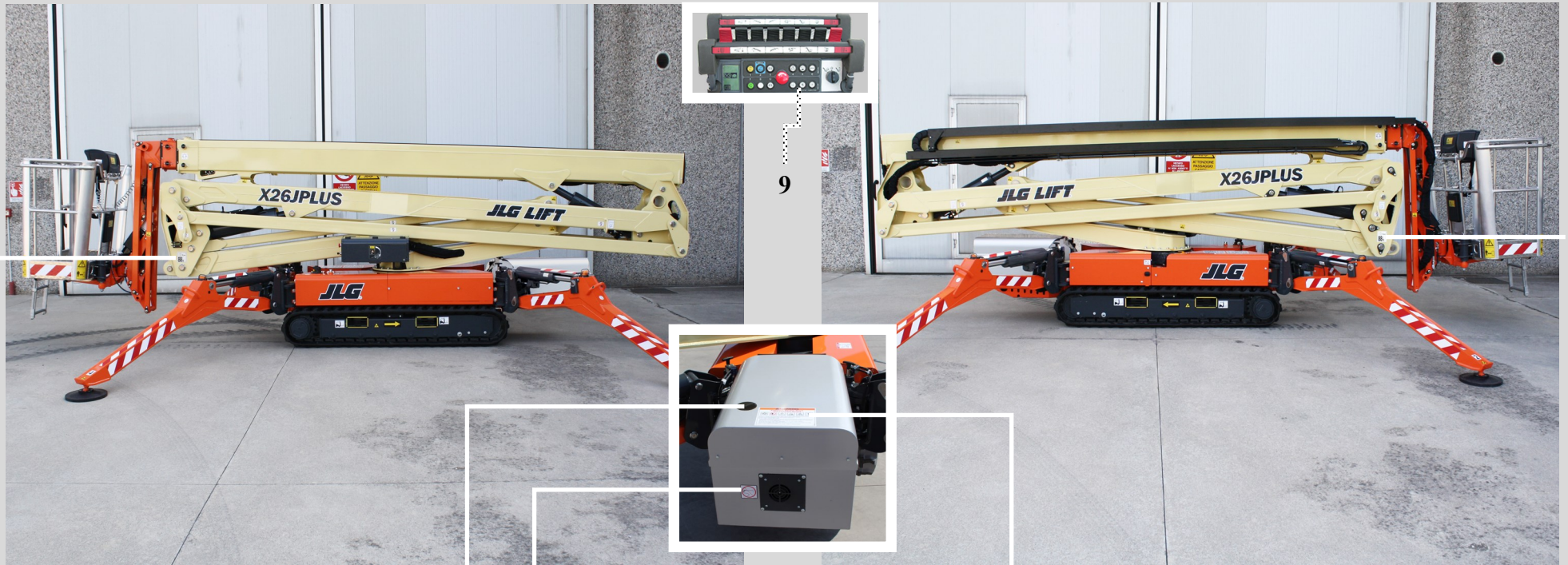

KIT ADESIVI X26JPLUS LITHIUM	AUFKLEBERSATZ X26JPLUS LITHIUM	cod. 17187700
SET OF DECALS X26JPLUS LITHIUM	KIT ADHESIVOS X26JPLUS LITHIUM	
KIT COLLANTS X26JPLUS LITHIUM	ADHESIEKIT X26JPLUS LITHIUM	Tav 01

KIT LITHIUM SERIE JLG/CE COD. 171877 POSIZIONE ADESIVI IN LINGUA / POSITION LANGUAGE STICKERS**

POS.	COD.	REV.	DESCRIZIONE / DESCRIPTION	Q.tà
	171877IT		KIT ADESIVI INTEGRAZIONE PIATTAFORME AEREE JLG/CE LITHIUM - LINGUA ITALIANO	
06	07188700	A	ADESIVO JLG ATTENZIONE PERICOLO BATTERIE - ITA L=210X145 MM	01
07	07188100	A	ADESIVO JLG RICARICARE LE BATTERIE DOPO L'USO O ALMENO OGNI 3 MESI L=50x50 MM – ITA	01
08 solo X17J	1705720001	A	ADESIVO ISTRUZIONI DISCESA DI EMERGENZA GL14703S LITHIUM ITALIANO L=290X175 MM (**)	01
08			Per le / for X14J-X19J-X23J • X13JP-X15JP-X17JP-X20JP-X26JP Vedere discesa di emergenza motore termico / See emergency lowering heat engine	
	171877GB		KIT ADESIVI INTEGRAZIONE PIATTAFORME AEREE JLG/CE LITHIUM - LINGUA INGLESE	
06	07201700	A	ADESIVO JLG ATTENZIONE PERICOLO BATTERIE - ING L=210X145 MM	01
07	07202100	A	ADESIVO JLG-CE RICARICARE LE BATTERIE DOPO L'USO ALMENO OGNI 3 MESI - ING L=50x50 MM	01
08 per X17J	1705720002	A	ADESIVO ISTRUZIONI DISCESA DI EMERGENZA GL14703S LITHIUM INGLESE L=290X175 MM	01
08			Per le / for X14J-X19J-X23J • X13JP-X15JP-X17JP-X20JP-X26JP Vedere discesa di emergenza motore termico / See emergency lowering heat engine	
	171877FR		KIT ADESIVI INTEGRAZIONE PIATTAFORME AEREE JLG/CE LITHIUM - LINGUA FRANCESE	
06	07201800	A	ADESIVO JLG ADESIVO ATTENZIONE PERICOLO BATTERIE - FRA L=210X145 MM	01
07	07202200	A	ADESIVO JLG RICARICARE LE BATTERIE DOPO L'USO ALMENO OGNI 3 MESI - FRA L=50x50 MM	01
08 per X17J	1705720003	A	ADESIVO ISTRUZIONI DISCESA DI EMERGENZA GL14703S LITHIUM FRANCESE L=290X175 MM (**)	01
08			Per le / for X14J-X19J-X23J • X13JP-X15JP-X17JP-X20JP-X26JP Vedere discesa di emergenza motore termico / See emergency lowering heat engine	

KIT LITHIUM SERIE JLG/CE COD. 171877 POSIZIONE ADESIVI IN LINGUA / POSITION LANGUAGE STICKERS**

POS.	COD.	REV.	DESCRIZIONE / DESCRIPTION	Q.tà
	171877DE		KIT ADESIVI INTEGRAZIONE PIATTAFORME AEREE JLG/CE LITHIUM - LINGUA TEDESCO	
06	07188800	A	ADESIVO JLG ATTENZIONE PERICOLO BATTERIE - TED L=210X145 MM	01
07	07188200	A	ADESIVO JLG RICARICARE LE BATTERIE DOPO L'USO O ALMENO OGNI 3 MESI L=50x50 MM –TED	01
08 per X17J	1705720004	A	ADESIVO ISTRUZIONI DISCESA DI EMERGENZA GL14703S LITHIUM TEDESCO L=290X175 MM (**)	01
08	Per le / for X14J-X19J-X23J • X13JP-X15JP-X17JP-X20JP-X26JP Vedere discesa di emergenza motore termico / See emergency lowering heat engine			
	171877ES		KIT ADESIVI INTEGRAZIONE PIATTAFORME AEREE JLG/CE LITHIUM - LINGUA SPAGNOLO	
06	07201900	A	ADESIVO JLG ATTENZIONE PERICOLO BATTERIE - SPA L=210X145 MM -	01
07	07202300	A	ADESIVO JLG RICARICARE LE BATTERIE DOPO L'USO ALMENO OGNI 3 MESI - SPA L=50x50 MM	01
08 per X17J	1705720005	A	ADESIVO ISTRUZIONI DISCESA DI EMERGENZA GL14703S LITHIUM SPAGNOLO L=290X175 MM (**)	01
08	Per le / for X14J-X19J-X23J • X13JP-X15JP-X17JP-X20JP-X26JP Vedere discesa di emergenza motore termico / See emergency lowering heat engine			
	171877NL		KIT ADESIVI INTEGRAZIONE PIATTAFORME AEREE JLG/CE LITHIUM - LINGUA OLANDESE	
06	07188900	A	ADESIVO JLG ATTENZIONE PERICOLO BATTERIE - OLA L=210X145 MM	01
07	07188300	A	ADESIVO JLG RICARICARE LE BATTERIE DOPO L'USO O ALMENO OGNI 3 MESI L=50x50 MM – OLA	01
08 per X17J	1705720006	A	ADESIVO ISTRUZIONI DISCESA DI EMERGENZA GL14703S LITHIUM OLANDESE L=290X175 MM (**)	01
08	Per le / for X14J-X19J-X23J • X13JP-X15JP-X17JP-X20JP-X26JP Vedere discesa di emergenza motore termico / See emergency lowering heat engine			

KIT LITHIUM SERIE JLG/CE COD. 171877 POSIZIONE ADESIVI IN LINGUA / POSITION LANGUAGE STICKERS**

POS.	COD.	REV.	DESCRIZIONE / DESCRIPTION	Q.tà
	171877SW		KIT ADESIVI INTEGRAZIONE PIATTAFORME AEREE JLG/CE LITHIUM - LINGUA SVEDESE	
06	07189000	A	ADESIVO JLG ATTENZIONE PERICOLO BATTERIE - SVE L=210X145 MM	01
07	07188400	A	ADESIVO JLG RICARICARE LE BATTERIE DOPO L'USO O ALMENO OGNI 3 MESI L=50x50 MM – SVE	01
08 per X17J	1705720010	A	ADESIVO ISTRUZ. DISCESA DI EMERGENZA GL14703S LITHIUM SVEDESE L=290X175 MM (**)	01
08	Per le / for X14J-X19J-X23J • X13JP-X15JP-X17JP-X20JP-X26JP			
	Vedere discesa di emergenza motore termico / See emergency lowering heat engine			
	171877PT		KIT ADESIVI INTEGRAZIONE PIATTAFORME AEREE JLG/CE LITHIUM - LINGUA PORTOGHESE	
06	07202000	A	ADESIVO JLG ATTENZIONE PERICOLO BATTERIE - POR L=210X145 MM	01
07	07202400	A	ADESIVO JLG RICARICARE LE BATTERIE DOPO L'USO O ALMENO OGNI 3 MESI L=50x50 MM – POR	01
08 per X17J	1705720007	A	ADESIVO ISTRUZ. DISCESA DI EMERGENZA GL14703S LITHIUM PORTOGHESE L=290X175 MM (**)	01
08	Per le / for X14J-X19J-X23J • X13JP-X15JP-X17JP-X20JP-X26JP			
	Vedere discesa di emergenza motore termico / See emergency lowering heat engine			
	171877DA		KIT ADESIVI INTEGRAZIONE PIATTAFORME AEREE JLG/CE LITHIUM - LINGUA DANESE	
06	07189100	A	ADESIVO JLG ATTENZIONE PERICOLO BATTERIE - DAN L=210X145 MM	01
07	07188500	A	ADESIVO JLG RICARICARE LE BATTERIE DOPO L'USO O ALMENO OGNI 3 MESI L=50x50 MM – DAN	01
08 per X17J	1705720011	A	ADESIVO ISTRUZ. DISCESA DI EMERGENZA GL14703S LITHIUM DANESE L=290X175 MM (**)	01
08	Per le / for X14J-X19J-X23J • X13JP-X15JP-X17JP-X20JP-X26JP			
	Vedere discesa di emergenza motore termico / See emergency lowering heat engine			

KIT LITHIUM SERIE JLG/CE COD. 171877 POSIZIONE ADESIVI IN LINGUA / POSITION LANGUAGE STICKERS**

POS.	COD.	REV.	DESCRIZIONE / DESCRIPTION	Q.tà
	171877NO		KIT ADESIVI INTEGRAZIONE PIATTAFORME AEREE JLG/CE LITHIUM - LINGUA NORVEGESE	
06	07189200	A	ADESIVO JLG ATTENZIONE PERICOLO BATTERIE - NOR L=210X145 MM	01
07	07188600	A	ADESIVO JLG RICARICARE LE BATTERIE DOPO L'USO O ALMENO OGNI 3 MESI L=50x50 MM – NOR	01
08 per X17J	1705720012	A	ADESIVO ISTRUZ. DISCESA DI EMERGENZA GL14703S LITHIUM NORVEGESE L=290X175 MM (**)	01
08	Per le / for X14J - X17JPLUS - X19J - X20JPLUS - X23J - X26JPLUS Vedere discesa di emergenza motore termico / See emergency lowering heat engine			
	171877RU		KIT ADESIVI INTEGRAZIONE PIATTAFORME AEREE JLG/CE LITHIUM - LINGUA RUSSO	
06	07920800	A	ADESIVO JLG ATTENZIONE PERICOLO BATTERIE - RUSSO L=210X145 MM	01
07	07910300	A	ADESIVO JLG RICARICARE LE BATTERIE DOPO L'USO O ALMENO OGNI 3 MESI L=50x50 MM – RUS	01
08 per X17J	/		/	/
08	Per le / for X14J - X17JPLUS - X19J - X20JPLUS - X23J - X26JPLUS Vedere discesa di emergenza motore termico / See emergency lowering heat engine			
	171877PL		KIT ADESIVI INTEGRAZIONE PIATTAFORME AEREE JLG/CE LITHIUM - LINGUA POLACCO	
06	07508000	A	ADESIVO JLG-ANSI ATTENZIONE PERICOLO BATTERIE - POLACCO L=210X145 MM	01
07	07508100	A	ADESIVO JLG-CE RICARICARE LE BATTERIE DOPO L'USO - POLACCO L=50x50 MM	01
08 per X17J	/		/	/
08	Per le / for X14J - X17JPLUS - X19J - X20JPLUS - X23J - X26JPLUS Vedere discesa di emergenza motore termico / See emergency lowering heat engine			

KIT LITHIUM SERIE JLG/CE COD. 171877 POSIZIONE ADESIVI IN LINGUA / POSITION LANGUAGE STICKERS**

POS.	COD.	REV.	DESCRIZIONE / DESCRIPTION	Q.tà
	171877SL		KIT ADESIVI INTEGRAZIONE PIATTAFORME AEREE JLG/CE LITHIUM - LINGUA SLOVENO	
06	07920900	A	ADESIVO JLG / CE ATTENZIONE PERICOLO BATTERIE - SLOVENO L=210X145 MM	01
07	07910500	A	ADESIVO JLG RICARICARE LE BATTERIE DOPO L'USO O ALMENO OGNI 3 MESI L=50x50 MM – SLO	01
08 per X17J	/	/	/	/
08	Per le / for X14J - X17JPLUS - X19J - X20JPLUS - X23J - X26JPLUS Vedere discesa di emergenza motore termico / See emergency lowering heat engine			
	171877FI		KIT ADESIVI INTEGRAZIONE PIATTAFORME AEREE JLG/CE LITHIUM - LINGUA FINLANDESE	
06	07921000	A	ADESIVO JLG / CE ATTENZIONE PERICOLO BATTERIE - FINLANDESE L=210X145 MM	01
07	07910600	A	ADESIVO JLG RICAR. LE BATTERIE DOPO L'USO O ALMENO OGNI 3 MESI L=50x50 MM – FINLANDE	01
08 per X17J	/	/	/	/
08	Per le / for X14J - X17JPLUS - X19J - X20JPLUS - X23J - X26JPLUS Vedere discesa di emergenza motore termico / See emergency lowering heat engine			
	171877CE		KIT ADESIVI INTEGRAZIONE PIATTAFORME AEREE JLG/CE LITHIUM - LINGUA CECO	
06	07921100	A	ADESIVO JLG-CE ATTENZIONE PERICOLO BATTERIE - CECO L=210X145 MM	01
07	07910700	A	ADESIVO JLG-CE RICARICARE LE BATTERIE DOPO L'USO ALMENO OGNI 3 MESI - JAPAN L=50x50 MM	01
08 per X17J	/	/	/	/
08	Per le / for X14J - X17JPLUS - X19J - X20JPLUS - X23J - X26JPLUS Vedere discesa di emergenza motore termico / See emergency lowering heat engine			
	171877JA		KIT ADESIVI INTEGRAZIONE PIATTAFORME AEREE JLG/CE LITHIUM - LINGUA GIAPPONESE	
06	07341100	A	ADESIVO JLG - CE ATTENZIONE PERICOLO BATTERIE - JAPAN L=210X145 MM	01
07	07341200	A	ADESIVO JLG-CE RICARICARE LE BATTERIE DOPO L'USO - JAPAN L=50x50 MM	01
08 per X17J	/	/	/	/
08	Per le / for X14J - X17JPLUS - X19J - X20JPLUS - X23J - X26JPLUS Vedere discesa di emergenza motore termico / See emergency lowering heat engine			

**KIT ADESIVI SICUREZZA PER PIATTAFORMA AEREA /
*STICKERS KIT SECURITY FOR AERIAL PLATFORM***

JLG/CE - X15JPLUS / X13JPLUS

Cod. 17788100

+ kit in lingua non incluso nel codice generale / *kit in the language not included in the general code*

**177881IT / 177881GB / 177881FR / 177881DE / 177881ES / 177881NL / 177881SW /
177881PT / 177881DA / 177881NO / 177881RU / 177881PL / 177881SL / 177881FI
177881CE / 177881JA**

DA USARE CON / FOR USE WITH

**COD. 17788200 KIT ADESIVI COMMERCIALI PER PIATTAFORMA AEREA / *STICKER KITS COMMERCIAL AERIAL PLATFORM*
JLG/CE X15JPLUS**

DA USARE CON / FOR USE WITH

**COD. 17788400 KIT ADESIVI COMMERCIALI PER PIATTAFORMA AEREA / *STICKER KITS COMMERCIAL AERIAL PLATFORM*
JLG/CE X13JPLUS**

**COD. 17187700 KIT INTEGRAZIONE ADESIVI PER PIATTAFORME AEREE JLG/CE LITHIUM /
*INTEGRATION KIT STICKERS PLATFORMS JLG / CE LITHIUM STICKER KIT INTEGRATION PLATFORM LITHIUM***

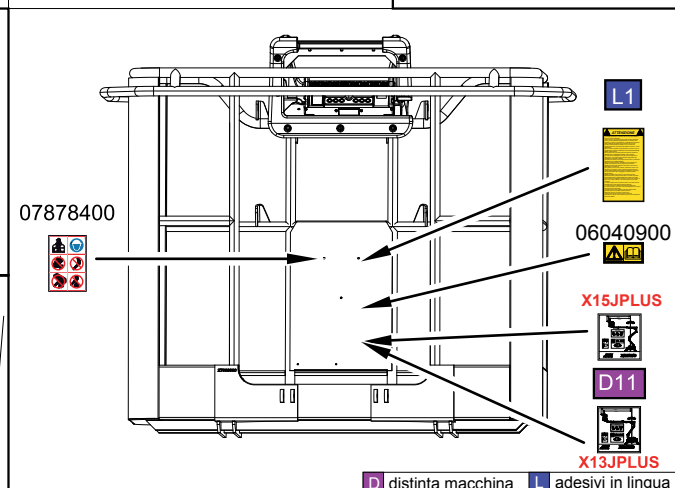
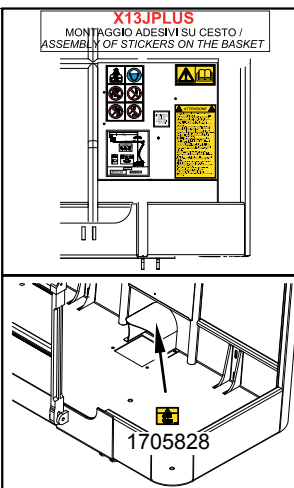
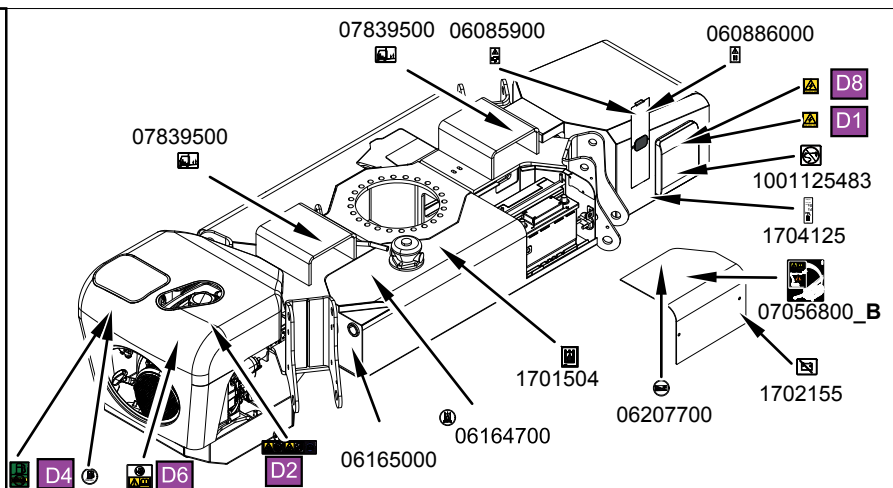
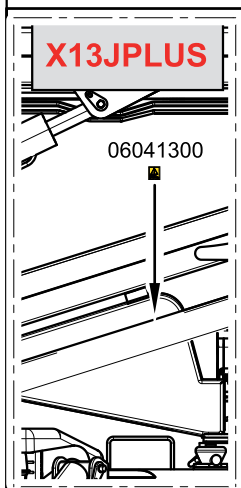
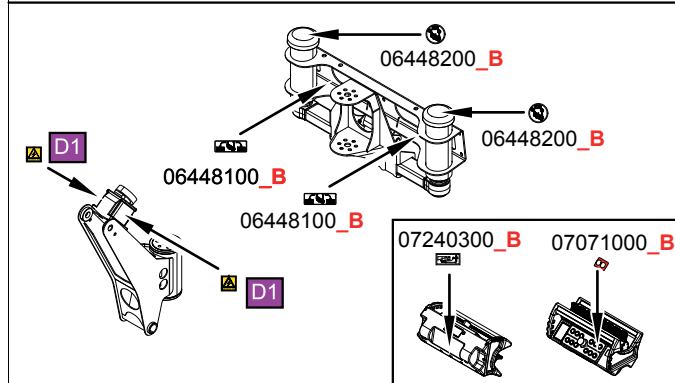
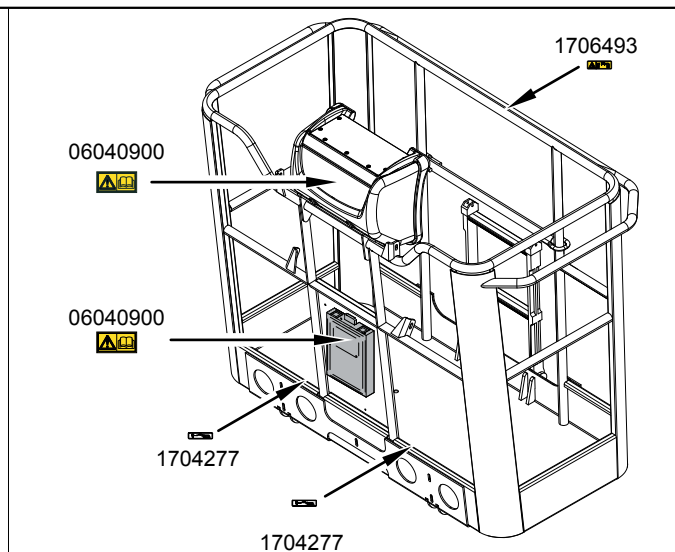
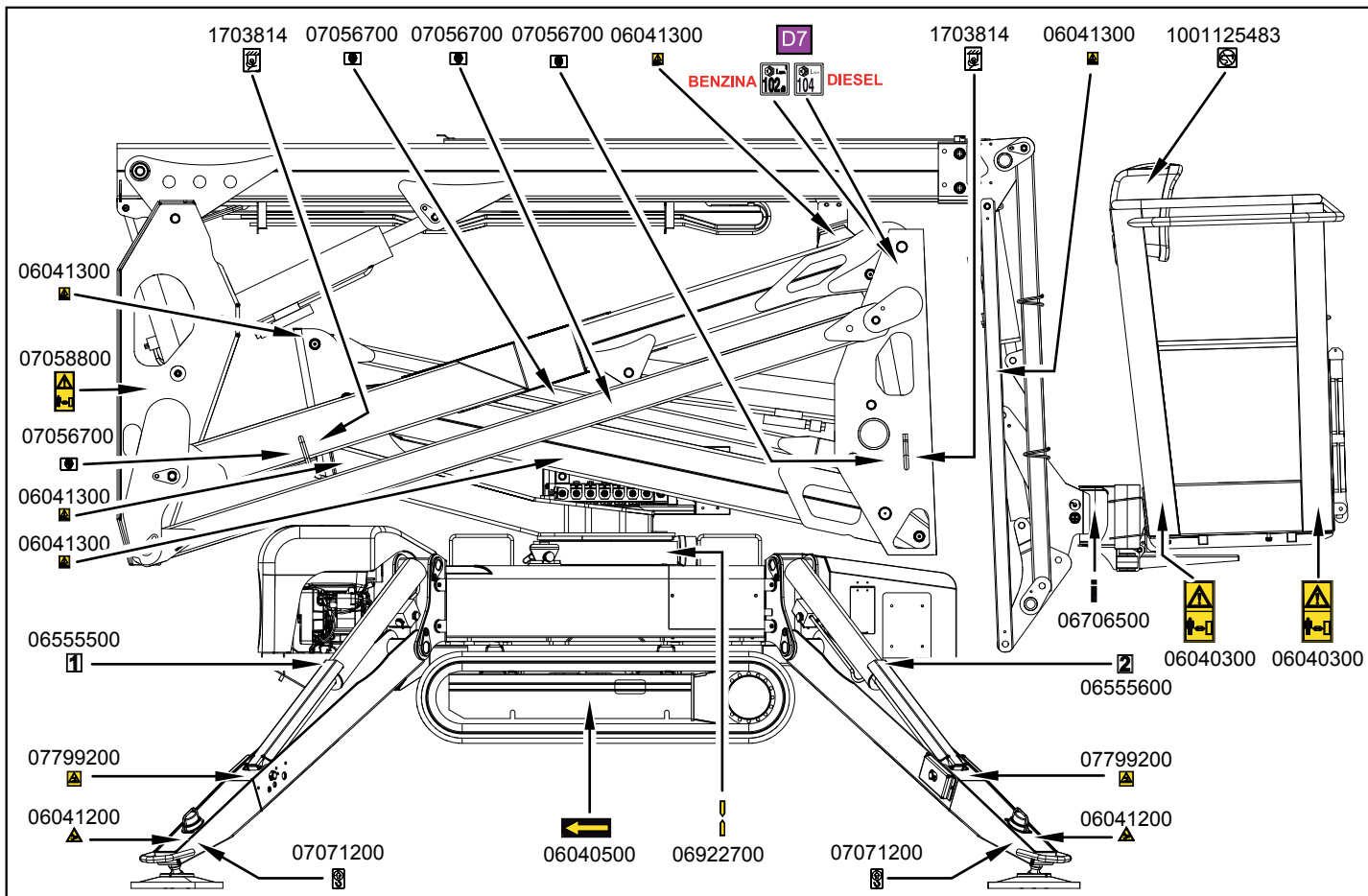

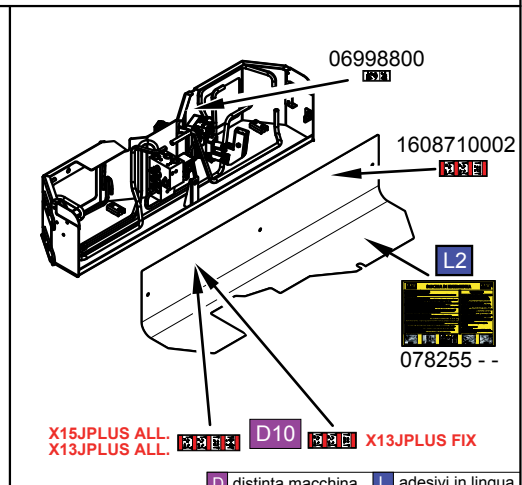
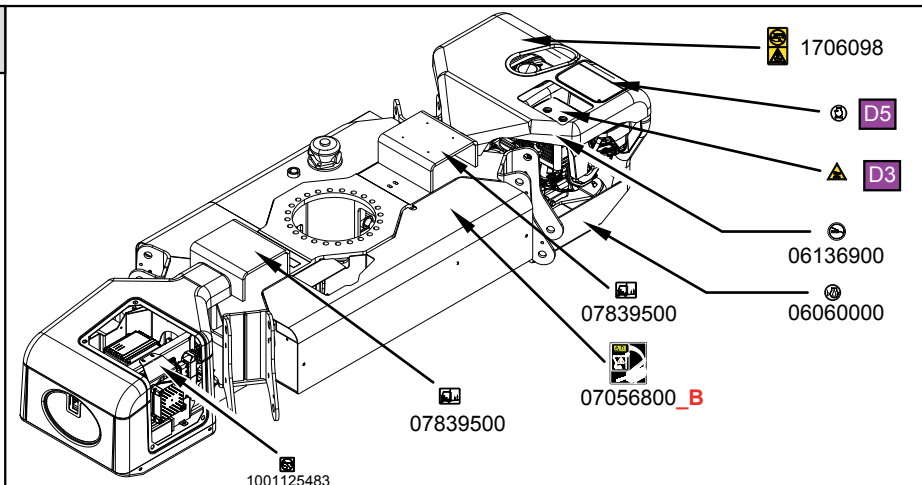
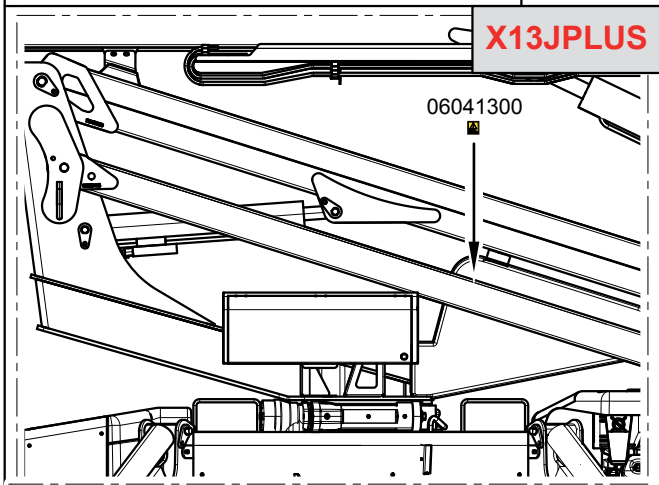
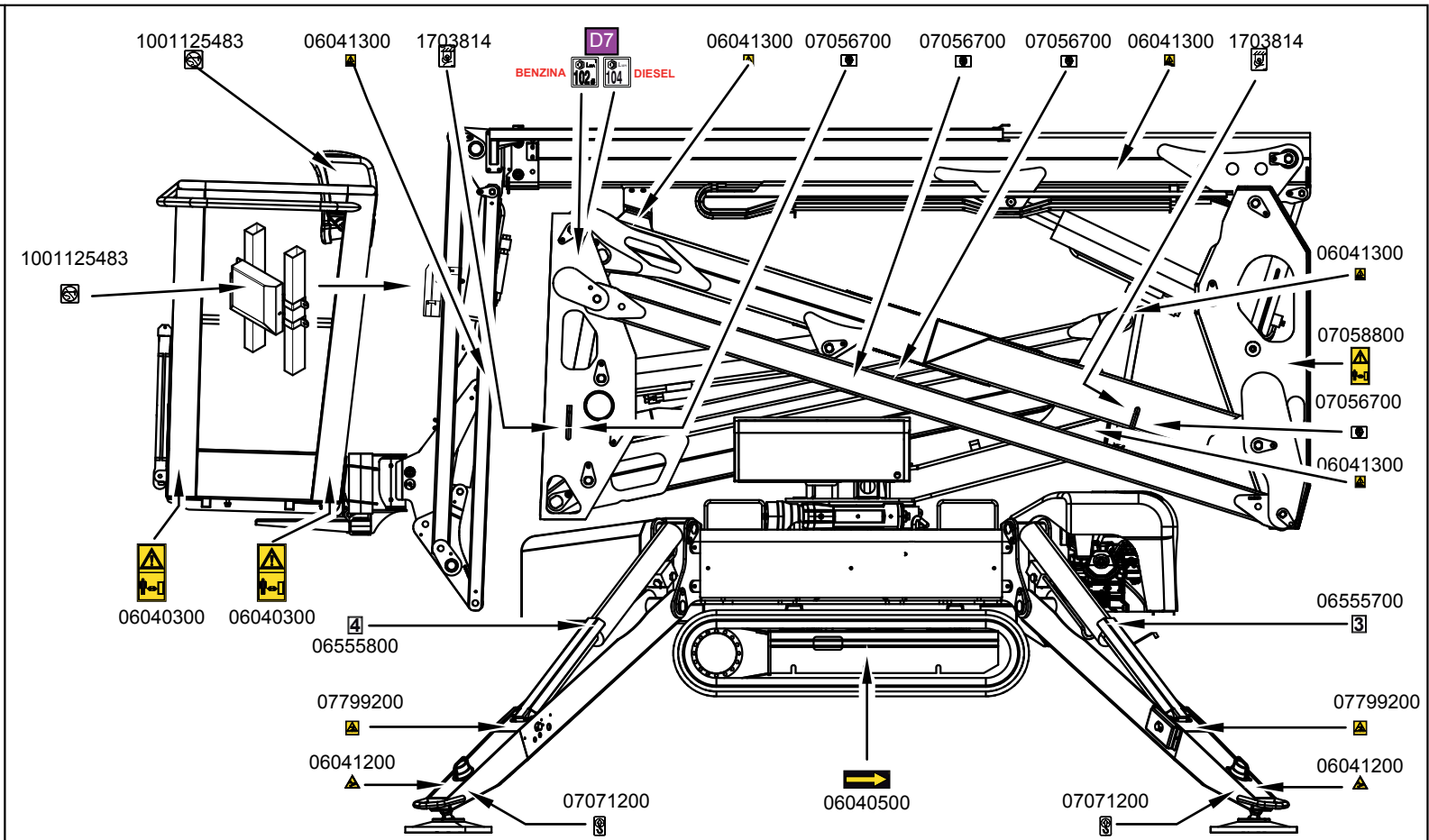
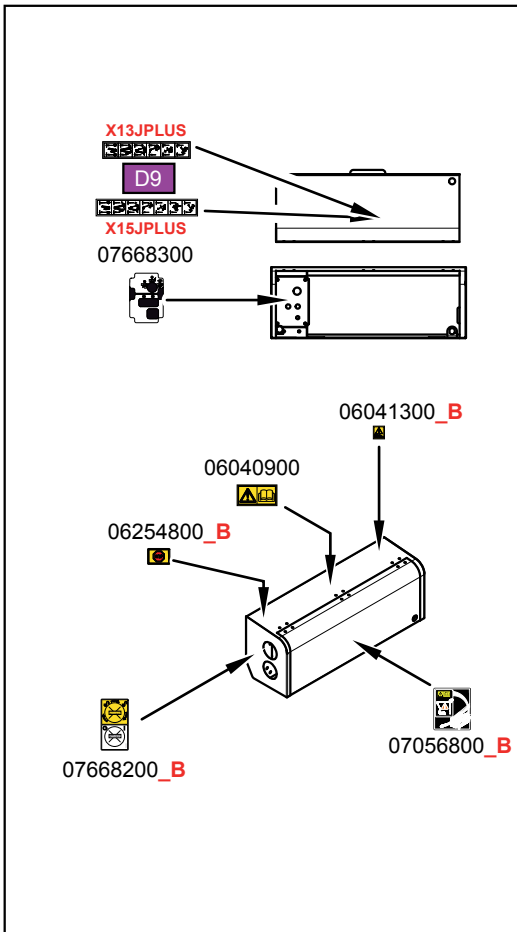

COD. 17788100 ADESIVI IN DISTINTA MACCHINA / STICKERS IN THE MACHINE LIST

VOLT

Num.	COD.	DESCRIZIONE / DESCRIPTION	Q.tà
D1	06042400	ADESIVO PERICOLO 110 VOLT 16A GIALLO _MOD_B	3
D1	06257300	ADESIVO PERICOLO 240 VOLT GIALLO L=47 X 47 MM	3
D1	06561200	ADESIVO PERICOLO 230 VOLT 16 AMPERE GIALLO L=47X47 MM _MOD_B	3
D2	06232100	ADESIVO ATTENZIONE BENZINA INFIAMMABILE L=170X42 MM _MOD_B	1
D3	06056300	ADESIVO PERICOLO SCOTTATURE TRIANGOLARE SFONDO GIALLO	1
D4	06041600	ADESIVO CARBURANTE BENZINA COLORE VERDE L=60 X 80 MM _MOD_B	1
D4	06043900	ADESIVO CARBURANTE DIESEL SFONDO BIANCO Ø 50 MM	1
D5	06164600	ADESIVO FILTRO ARIA SFONDO BIANCO Ø50 MM	1
D6	06227200	ADESIVO CONTROLLARE LIVELLO OLIO MOTORE L=80X80 MM _MOD_B	1
D7	07802200	ADESIVO RUMORE 102 dB L=90X100 MM (MOTORE BENZINA)	2
	07034200	ADESIVO RUMORE 104 dB L=90X100 MM (MOTORE DIESEL _MOD_B	
D8	07668000	ADESIVO PERICOLO 110 VOLT 32A GIALLO L=47 X 47 MM	1
D9	07668100	ADESIVO PULSANTI DISTRIBUTORE PARTE AEREA LL2614 L=318X52 MM - (PER 1570)	1
	07864500	ADESIVO PULSANTI DISTRIBUTORE PARTE AEREA LL13.70 L=274X52 MM - (PER 1370)	1
D10	1608710001	ADESIVO PULSANTI DISTRIBUTORE A TERRA LATO SX GL17.80 L= 194X50 MM _MOD_C - (PER 1570)	1
	07864600	ADESIVO PULSANTI DISTRIBUTORE A TERRA LATO SX LL13.70 L= 150X50 MM - (PER 1370)	1
D11	07799400	ADESIVO PORTATA CESTO 2 PERSONE X15JPLUS L=135X145 MM	1
	07868200	ADESIVO PORTATA CESTO 2 PERSONE X13JPLUS L=135X145 MM	1
			1

COD. 17788100 ELENCO ADESIVI / LIST STICKERS

---	COD.	DESCRIZIONE / DESCRIPTION	Q.tà
	06040300	ADESIVO PERICOLO MANTENERE LE DISTANZE GIALLO L=100 X 200 MM	4
	06040500	ADESIVO DIREZ. TRASLAZIONE FRECCIA GIALLA SFONDO NERO L=61 X 160 MM	2
	06040900	ADESIVO LEGGERE IL MANUALE GIALLO L=125 X 65 MM	5
	06041200	ADESIVO SCHIACCIAMENTO PIEDI TRIANGOLARE L=53X46 MM	4
	06041300	ADESIVO ATTENZIONE PERICOLO TAGLI L=35 X 40 MM GIALLO_ MOD_B	13
	06060000	ADESIVO LIVELLO OLIO MOTORE Ø50 MM	1
	06085900	ADESIVO SISTEMA BYPASS PARTE AEREA L=30X50 MM	1
	06086000	ADESIVO SISTEMA BYPASS TRASLAZIONE L=30X50 MM (**)	1
	06136900	ADESIVO PUNTI INGRASSAGGIO Ø 55 TESTO NERO - SFONDO BIANCO	1
	06164700	ADESIVO FILTRO OLIO IDRAULICO BIANCO Ø50 MM	1
	06165000	ADESIVO LIVELLO OLIO IDRAULICO SFONDO BIANCO Ø50 MM	1
	06207700	ADESIVO BATTERIA POLO POSITIVO POLO NEGATIVO BIANCO Ø50 (**)	1
	06254800	ADESIVO STOP EMERGENZA SFONDO GIALLO L=70X50 MM_ MOD_B	1
	06448100	ADESIVO RIPRISTINARE I TAPPI FERMO GUIDA L= 100X35 MM_ MOD_B	2
	06448200	ADESIVO "SBLOCCARE SOLO NEI CASI PREVISTI" Ø 60 MM_ MOD_B	2
	06555500	ADESIVO NR 1 BIANCO L=50X60 MM	1
	06555600	ADESIVO NR 2 BIANCO L=50X60 MM	1
	06555700	ADESIVO NR 3 BIANCO L=50X60 MM	1
	06555800	ADESIVO NR 4 BIANCO L=50X60 MM	1
	06706500	ADESIVO ALLINEAMENTO CESTO (2 PEZZI) L=16X50+13(**)	1
	06922700	ADESIVO FRECCIA ALLINEAMENTO L=50x15 (**)	2
	06998800	ADESIVO DEVIATORE POMPA MANUALE PIATTAFORMA GL17. 80XL L=86X34 MM	1
	07056700	ADESIVO JLG DIVIETO DI SOLLEVAMENTO L=54,88X40	8
	07056800	ADESIVO JLG DISCESA DI EMERGENZA ALL'INTERNO L=114X130 MM_ MOD_B	3

COD. 17788100 ELENCO ADESIVI / LIST STICKERS

---	COD.	DESCRIZIONE / DESCRIPTION	Q.tà
	07058800	ADESIVO PERICOLO MANTENERE LE DISTANZE L=65X130 MM - GIALLO	2
	07071000	ADESIVO JLG CLAXON SU PIATTAFORME L=39,3X28,55 MM_ MOD_B	1
	07071200	ADESIVO JLG PUNTO DI SOLLEVAMENTO L= 40X66 MM	8
	07240300	ADESIVO DISTANZA 1 METRO SU TELE/RADIO COMANDI L= 75x35 MM_ MOD_B	1
	07668200	ADESIVO EMERGENCY STOP E BLOCCHETTO ACCENSIONE L= 85x160 MM_ MOD_B	1
	07668300	ADESIVO SELETTORE SCATOLA COMANDI TERRA / CESTO L= 105X155 MM	1
	07799200	ADESIVO REAZIONE AL SUOLO STABILIZZATORI LL1570 1670 daN L=45x48 MM	4
	07839500	ADESIVO SOLLEVAMENTO PIATTAFORMA CON MULETTO - PICCOLO L=65X50 MM	4
	07878400	ADESIVO CASCO IMBRAGATURA E DIVIETI LL1370 L=175X118 MM	1
	1001125483	ADESIVO JLG VIETATO LAVARE L=63,5X63,5 MM	7
	1608710002	ADESIVO PULSANTI DISTRIBUTORE A TERRA LATO DX GL17.80 L L=150X50 MM_ MOD_C	1
	1701504	ADESIVO JLG OLIO IDRAULICO L=50,8x63,5 MM (**)	1
	1702155	ADESIVO JLG STACCABATTERIA L= 63,5X50,80 MM	1
	1703814	ADESIVO JLG ATTACCO ANCORAGGIO L=55,56X76,2 MM	4
	1704125	ADESIVO JLG ATTACCO ARIA E OLIO L=25,4X76,2 MM	1
	1704277	ADESIVO JLG ATTACCO CINTURE DI SICUREZZA L= 76,2X19,05 MM	2
	1705828	ADESIVO JLG INTERUTTORE PEDALE L= 69,85X54 _ MOD_B	1
	1706098	ADESIVO JLG PERICOLO ESPLOSIONE L=63,5X117,475 MM_ MOD_B	1
	1706493	ADESIVO JLG SCORRIMENTO SBARRA CHIUSURA CESTO L= 76, 2X25,4 MM_ MOD_B	1
	07799500	ADESIVO JLG PORTATA CESTO 1 PERSONA X15JPLUS L=135X145 MM “ non in distinta “	1
	07868400	ADESIVO JLG PORTATA CESTO 1 PERSONA X13JPLUS L=135X145 MM “ non in distinta “	1

ELENCO ADESIVI IN LINGUA / LIST LANGUAGE STICKERS

Num.	COD.	DESCRIZIONE / DESCRIPTION	Q.tà
	177881IT	ADESIVI IN LINGUA PER JLG/CE X15JPLUS - LINGUA ITALIANO	
L1	06555300	ADESIVO USO PIATTAFORMA AEREA CINGOLATA - ITALIANO L=128X230 _MOD_C	01
L2	078255IT	ADESIVO DISCESA DI EMERG. LL15.70 MOTORE TERMICO E LITHIUM - ITALIANO L=290X205 MM	01
	177881GB	ADESIVI IN LINGUA PER JLG/CE X15JPLUS - LINGUA INGLESE	
L1	06562600	ADESIVO USO PIATTAFORMA AEREA CINGOLATA - INGLESE L=128X230 _MOD_C	01
L2	078255GB	ADESIVO DISCESA DI EMERG. LL15.70 MOTORE TERMICO E LITHIUM - INGLESE L=290X205 MM	01
	177881FR	ADESIVI IN LINGUA PER JLG/CE X15JPLUS - LINGUA FRANCESE	
L1	06562700	ADESIVO USO PIATTAFORMA AEREA CINGOLATA - FRANCESE L=128X230 _MOD_C	01
L2	078255FR	ADESIVO DISCESA DI EMERG. LL15.70 MOTORE TERMICO E LITHIUM - FRANCESE L=290X205 MM	01
	177881DE	ADESIVI IN LINGUA PER JLG/CE X15JPLUS - LINGUA TEDESCO	
L1	06562800	ADESIVO USO PIATTAFORMA AEREA CINGOLATA - TEDESCO L=128X230 _MOD_C	01
L2	078255DE	ADESIVO DISCESA DI EMERG.LL15.70 MOTORE TERMICO E LITHIUM - TEDESCO L=290X205 MM	01
	177881ES	ADESIVI IN LINGUA PER JLG/CE X15JPLUS - LINGUA SPAGNOLO	
L1	06562900	ADESIVO USO PIATTAFORMA AEREA CINGOLATA - SPAGNOLO L=128X230 _MOD_C	01
L2	078255ES	ADESIVO DISCESA DI EMERG. LL15.70 MOTORE TERMICO E LITHIUM - SPAGNOLO L=290X205 MM	01
	177881NL	ADESIVI IN LINGUA PER JLG/CE X15JPLUS - LINGUA OLANDESE	
L1	06563000	ADESIVO USO PIATTAFORMA AEREA CINGOLATA - OLANDESE L=128X230 _MOD_C	01
L2	078255NL	ADESIVO DISCESA DI EMERG. LL15.70 MOTORE TERMICO E LITHIUM - OLANDESE L=290X205 MM	01

ELENCO ADESIVI IN LINGUA / LIST LANGUAGE STICKERS

Num.	COD.	DESCRIZIONE / DESCRIPTION	Q.tà
	177881SW	ADESIVI IN LINGUA PER JLG/CE X15JPLUS - LINGUA SVEDESE	
L1	07137300	ADESIVO USO PIATTAFORMA AEREA CINGOLATA - SVEDESE L= 128X230 MM _MOD_C	01
L2	078255SW	ADESIVO DISCESA DI EMERG. LL15.70 MOTORE TERMICO E LITHIUM - SVEDESE L=290X205 MM	01
	177881PT	ADESIVI IN LINGUA PER JLG/CE X15JPLUS - LINGUA PORTOGHESE	
L1	06563100	ADESIVO USO PIATTAFORMA AEREA CINGOLATA - PORTOGHESE L=128X230 _MOD_C	01
L2	078255PT	ADESIVO DISCESA DI EMERG. LL15.70 MOTORE TERMICO E LITHIUM - PORTOGHESE L=290X205 MM	01
	177881DA	ADESIVI IN LINGUA PER JLG/CE X15JPLUS - LINGUA DANESE	
L1	07138100	ADESIVO USO PIATTAFORMA AEREA CINGOLATA - DANESE L= 128X230 MM _MOD_C	01
L2	078255DA	ADESIVO DISCESA DI EMERG. LL15.70 MOTORE TERMICO E LITHIUM - DANESE L=290X205 MM	01
	177881NO	ADESIVI IN LINGUA PER JLG/CE X15JPLUS - LINGUA NORVEGESE	
L1	07162000	ADESIVO USO PIATTAFORMA AEREA CINGOLATA - NORVEGESE L=128X230 MM _MOD_C	01
L2	078255NO	ADESIVO DISCESA DI EMERG. LL15.70 MOTORE TERMICO E LITHIUM - NORVEGESE L=290X205 MM	01
	177881RU	ADESIVI IN LINGUA PER JLG/CE X15JPLUS - LINGUA RUSSO	
L1	07514800	ADESIVO USO PIATTAFORMA AEREA CINGOLATA - RUSSO L=128X230 MM	01
L2	078255RU	ADESIVO DISCESA DI EMERG. LL15.70 MOTORE TERMICO E LITHIUM - RUSSO L=290X205 MM	01
	177881PL	ADESIVI IN LINGUA PER JLG/CE X15JPLUS - LINGUA POLACCO	
L1	07506600	ADESIVO USO PIATTAFORMA AEREA CINGOLATA - POLACCO L= 128X230 MM _MOD_B**	01
L2	078255PL	ADESIVO DISCESA DI EMERG. LL15.70 MOTORE TERMICO E LITHIUM - POLACCO L=290X205 MM	01

F gwci riq'f kuvpvc

distinta 17788100	Descrizione KIT ADESIVI DI SICUREZZA PER PIATTAFORMA AEREA JLG/CE - X			quantità componenti percentuale <input type="checkbox"/>	Disegno
Tipo Articolo	Data creazione 06/04/2016	Data ultimo aggiorn 03/10/2017	Unità di misura NR	Nota	

Tipo	Componente	Descrizione	N.F.	Da Espl.	Quantità	Qtà perc.	Un. mis.	Quantità sfridi	Un. mis.	Nota
Articolo	06040300	ADESIVO PERICOLO MANTENERE LE DISTANZE GIALLO L=100 X 200 MM		Si	4,00	0,00	NR	0,00	NR	
Articolo	06040500	ADESIVO DIREZIONE TRASLAZIONE FRECCIA GIALLA SFONDO NERO L=61 X 160 MM		Si	2,00	0,00	NR	0,00	NR	
Articolo	06040900	ADESIVO LEGGERE IL MANUALE GIALLO L=125 X 65 MM		Si	5,00	0,00	NR	0,00	NR	
Articolo	06041200	ADESIVO SCHIACCIAMENTO PIEDI TRIANGOLARE L=53X46 MM		Si	4,00	0,00	NR	0,00	NR	
Articolo	06041300	ADESIVO ATTENZIONE PERICOLO TAGLI L=35 X 40 MM GIALLO_ MOD_B		Si	13,00	0,00	NR	0,00	NR	
Articolo	06060000	ADESIVO LIVELLO OLIO MOTORE Ø50 MM		Si	1,00	0,00	NR	0,00	NR	
Articolo	06085900	ADESIVO SISTEMA BYPASS PARTE AEREA L=30X50 MM		Si	1,00	0,00	NR	0,00	NR	
Articolo	06086000	ADESIVO SISTEMA BYPASS TRASLAZIONE L=30X50 MM (**)		Si	1,00	0,00	NR	0,00	NR	
Articolo	06136900	ADESIVO PUNTI INGRASSAGGIO Ø 55 MM		Si	1,00	0,00	NR	0,00	NR	
Articolo	06164700	ADESIVO FILTRO OLIO IDRAULICO BIANCO Ø50 MM		Si	1,00	0,00	NR	0,00	NR	
Articolo	06165000	ADESIVO LIVELLO OLIO IDRAULICO SFONDO BIANCO Ø50 MM		Si	1,00	0,00	NR	0,00	NR	
Articolo	06207700	ADESIVO BATTERIA POLO POSITIVO POLO NEGATIVO BIANCO Ø50 MM (**)		Si	1,00	0,00	NR	0,00	NR	
Articolo	06254800	ADESIVO STOP EMERGENZA SFONDO GIALLO L=70X50 MM_MOD_ B		Si	1,00	0,00	NR	0,00	NR	
Articolo	06448100	ADESIVO RIPRISTINARE I TAPPI FERMO GUIDA L= 100X35 MM_ MOD_B		Si	2,00	0,00	NR	0,00	NR	
Articolo	06448200	ADESIVO "SBLOCCARE SOLO NEI CASI PREVISTI" Ø 60 MM_MOD_B		Si	2,00	0,00	NR	0,00	NR	
Articolo	06555500	ADESIVO NR 1 BIANCO L=50X60 MM		Si	1,00	0,00	NR	0,00	NR	
Articolo	06555600	ADESIVO NR 2 BIANCO L=50X60 MM		Si	1,00	0,00	NR	0,00	NR	
Articolo	06555700	ADESIVO NR 3 BIANCO L=50X60 MM		Si	1,00	0,00	NR	0,00	NR	
Articolo	06555800	ADESIVO NR 4 BIANCO L=50X60 MM		Si	1,00	0,00	NR	0,00	NR	
Articolo	06706500	ADESIVO ALLINEAMENTO CESTO (2 PEZZI) L=16X50+13(**)		Si	1,00	0,00	NR	0,00	NR	
Articolo	06922700	ADESIVO FRECCIA ALLINEAMENTO L=50x15 (**)		Si	2,00	0,00	NR	0,00	NR	
Articolo	06998800	ADESIVO DEVIATORE POMPA MANUALE PIATTAFORMA GL17.		Si	1,00	0,00	NR	0,00	NR	

F g w c i r t q ' f k u v p v c

distinta 17788100	Descrizione KIT ADESIVI DI SICUREZZA PER PIATTAFORMA AEREA JLG/CE - X			quantità componenti percentuale <input type="checkbox"/>	Disegno
Tipo Articolo	Data creazione 06/04/2016	Data ultimo aggiorn 03/10/2017	Unità di misura NR	Nota	

Tipo	Componente	Descrizione	N.F.	Da Espl.	Quantità	Qtà perc.	Un. mis.	Quantità sfridi	Un. mis.	Nota
		80XL L=86X34 MM								
Articolo	07056700	ADESIVO JLG DIVIETO DI SOLLEVAMENTO L=54,88X40		Si	8,00	0,00	NR	0,00	NR	
Articolo	07056800	ADESIVO JLG DISCESA DI EMERGENZA ALL'INTERNO L=114X130 MM_MOD_B		Si	3,00	0,00	NR	0,00	NR	
Articolo	07058800	ADESIVO PERICOLO MANTENERE LE DISTANZE L=65X130 MM - GIALLO		Si	2,00	0,00	NR	0,00	NR	
Articolo	07071000	ADESIVO JLG CLAXON SU PIATTAFORME L=39,3X28,55 MM_MOD_ B		Si	1,00	0,00	NR	0,00	NR	
Articolo	07071200	ADESIVO JLG PUNTO DI SOLLEVAMENTO L= 40X66 MM		Si	8,00	0,00	NR	0,00	NR	
Articolo	07240300	ADESIVO DISTANZA 1 METRO SU TELE/RADIO COMANDI L= 75x35 MM_MOD_B		Si	1,00	0,00	NR	0,00	NR	
Articolo	07668200	ADESIVO EMERGENCY STOP E BLOCCHETTO ACCENSIONE L= 85x160 MM_MOD_B		Si	1,00	0,00	NR	0,00	NR	
Articolo	07668300	ADESIVO SELETTORE SCATOLA COMANDI TERRA / CESTO L= 105X155 MM		Si	1,00	0,00	NR	0,00	NR	
Articolo	07799200	ADESIVO REAZIONE AL SUOLO STABILIZZATORI LL1570 1670 daN L=45x48 MM		Si	4,00	0,00	NR	0,00	NR	
Articolo	07878400	ADESIVO CASCO IMBRAGATURA E DIVIETI LL1370 L=175X118 MM		Si	1,00	0,00	NR	0,00	NR	
Articolo	07839500	ADESIVO SOLLEVAMENTO PIATTAFORMA CON MULETTO - PICCOLO L=65X50 MM		Si	4,00	0,00	NR	0,00	NR	
Articolo	1001125483	ADESIVO JLG VIETATO LAVARE L=63,5X63,5 MM		Si	7,00	0,00	NR	0,00	NR	
Articolo	1608710002	ADESIVO PULSANTI DISTRIBUTORE A TERRA LATO DX GL17.80 L L=150X50 MM_MOD_C		Si	1,00	0,00	NR	0,00	NR	
Articolo	1701504	ADESIVO JLG OLIO IDRAULICO L=50,8x63,5 MM (**)		Si	1,00	0,00	NR	0,00	NR	
Articolo	1702155	ADESIVO JLG STACCABATTERIA L= 63,5X50,80 MM		Si	1,00	0,00	NR	0,00	NR	
Articolo	1703814	ADESIVO JLG ATTACCO ANCORAGGIO L=55,56X76,2 MM		Si	4,00	0,00	NR	0,00	NR	
Articolo	1704125	ADESIVO JLG ATTACCO ARIA E ACQUA L=25,4X76,2 MM		Si	1,00	0,00	NR	0,00	NR	
Articolo	1704277	ADESIVO JLG ATTACCO CINTURE DI SICUREZZA L= 76,2X19,05 MM		Si	2,00	0,00	NR	0,00	NR	

AGGIORNATO IL / UPDATED 02/11/2016

**KIT ADESIVI COMMERCIALI PER PIATTAFORMA AEREA /
*STICKERS KIT COMMERCIAL FOR AERIAL PLATFORM***

JLG/CE X15JPLUS

Cod. 17788200

DA USARE CON / FOR USE WITH
COD. 17788100 *KIT ADESIVI DI SICUREZZA PER PIATTAFORMA AEREA / STICKER KITS SECURITY AERIAL
PLATFORM*

A STABILIZZATORI CHIUSI CENTRARE SUL BRACCIO SIA IN ALTEZZA CHE IN LARGHEZZA IL LOGO JLG LIFT
A CLOSED CENTRALISE REGULATORS ON ARM IS IN HEIGHT TO WIDTH IN THE LOGO JLG LIFT

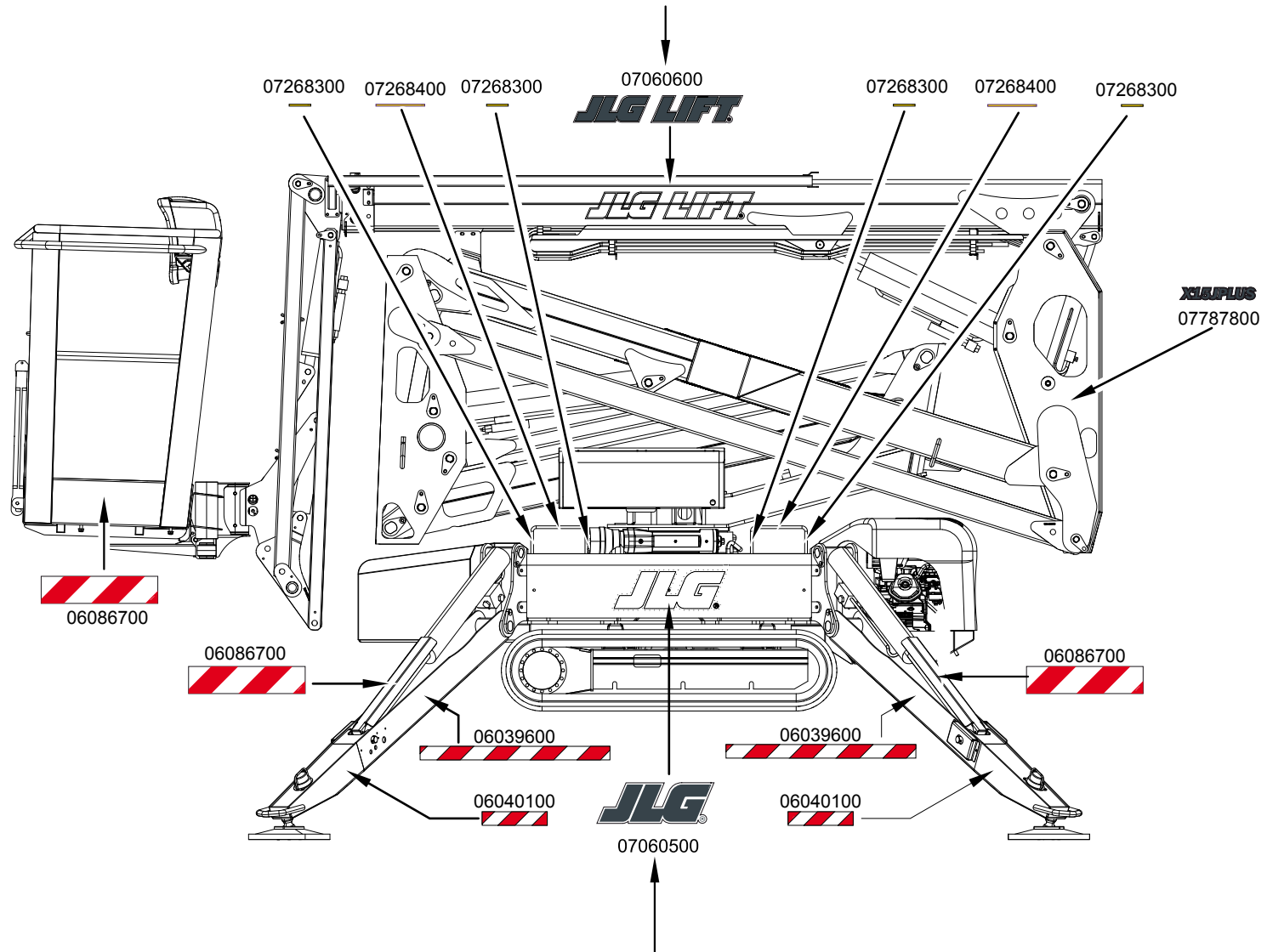

A STABILIZZATORI CHIUSI CENTRARE SUL COPERCHIO SIA IN ALTEZZA CHE IN LARGHEZZA IL LOGO JLG
A CLOSED CENTRALISE REGULATORS ON THE COVER IS IN HEIGHT TO WIDTH IN THE LOGO JLG

A STABILIZZATORI CHIUSI CENTRARE SUL BRACCIO SIA IN ALTEZZA CHE IN LARGHEZZA IL LOGO JLG LIFT
A CLOSED CENTRALISE REGULATORS ON ARM IS IN HEIGHT TO WIDTH IN THE LOGO JLG LIFT

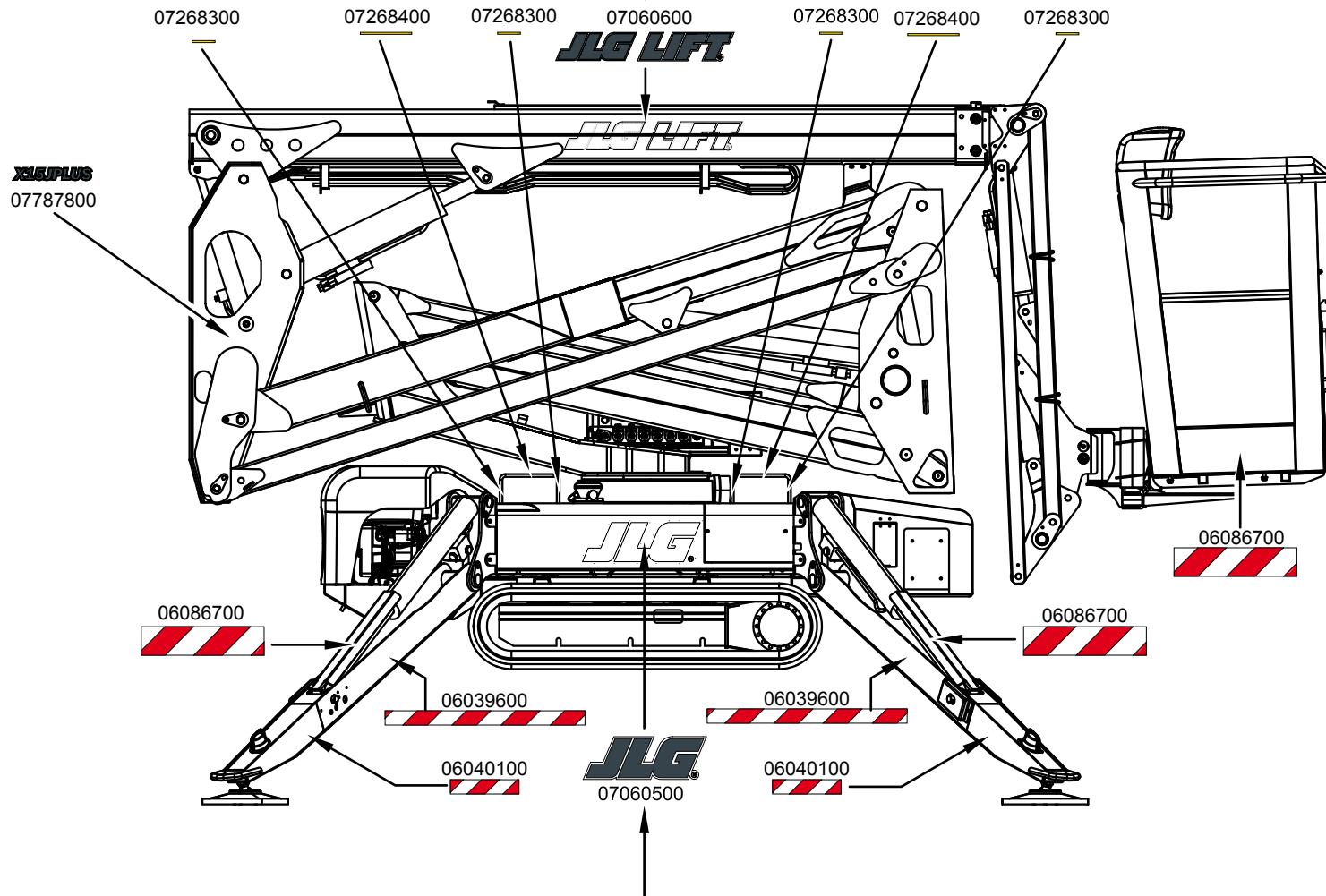

A STABILIZZATORI CHIUSI CENTRARE SUL COPERCHIO SIA IN ALTEZZA CHE IN LARGHEZZA IL LOGO JLG
A CLOSED CENTRALISE REGULATORS ON THE COVER IS IN HEIGHT TO WIDTH IN THE LOGO JLG

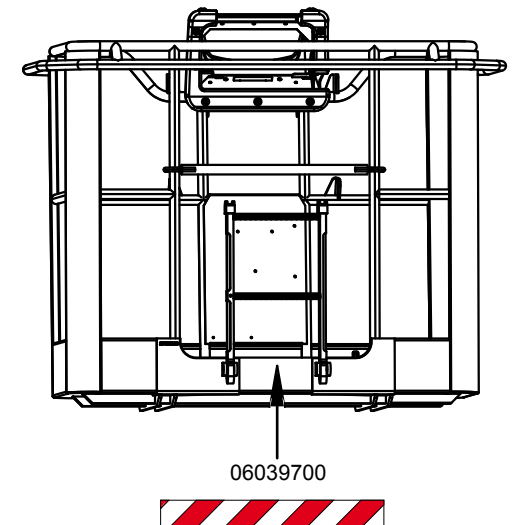



AGGIORNATO IL / UPDATED 28/11/2019

**KIT ADESIVI SICUREZZA PER PIATTAFORMA AEREA /
*STICKERS KIT SECURITY FOR AERIAL PLATFORM***

JLG/ANSI - X370AJ - JLG/ANSI X430AJ

Cod. 17788300

+ kit in lingua non incluso nel codice generale / *kit in the language not included in the general code*

177883GB / 177883FR / 177883ES / 177883PT

DA USARE CON / FOR USE WITH

**COD. 17859200 KIT ADESIVI COMMERCIALI PER PIATTAFORMA AEREA / *STICKER KITS COMMERCIAL AERIAL PLATFORM*
JLG/CE X370AJ**

DA USARE CON / FOR USE WITH

**COD. 17788400 KIT ADESIVI COMMERCIALI PER PIATTAFORMA AEREA / *STICKER KITS COMMERCIAL AERIAL PLATFORM*
JLG/CE X430AJ**

**16924900 KIT INTEGRAZIONE ADESIVI PIATTAFORME 3S LITHIUM /
*STICKER KIT INTEGRATION PLATFORM LITHIUM***

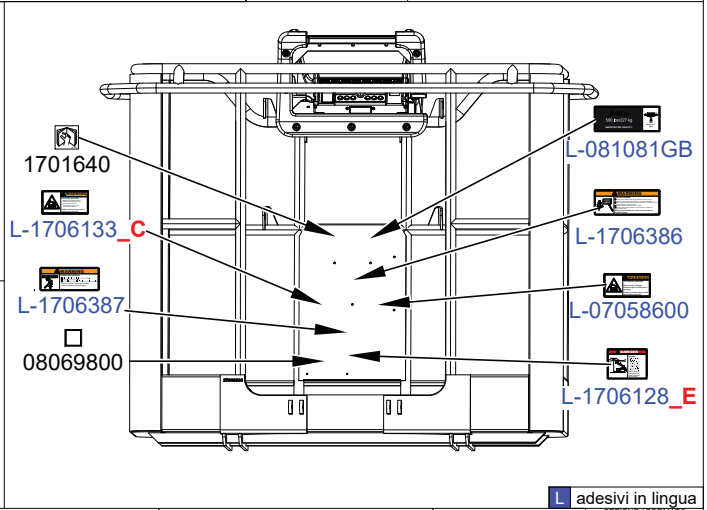
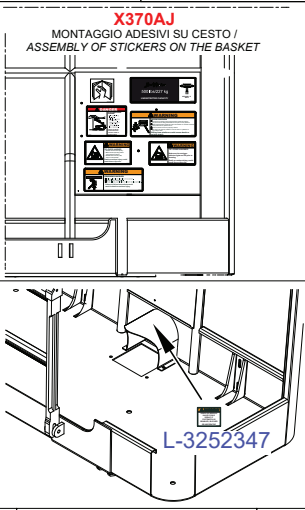
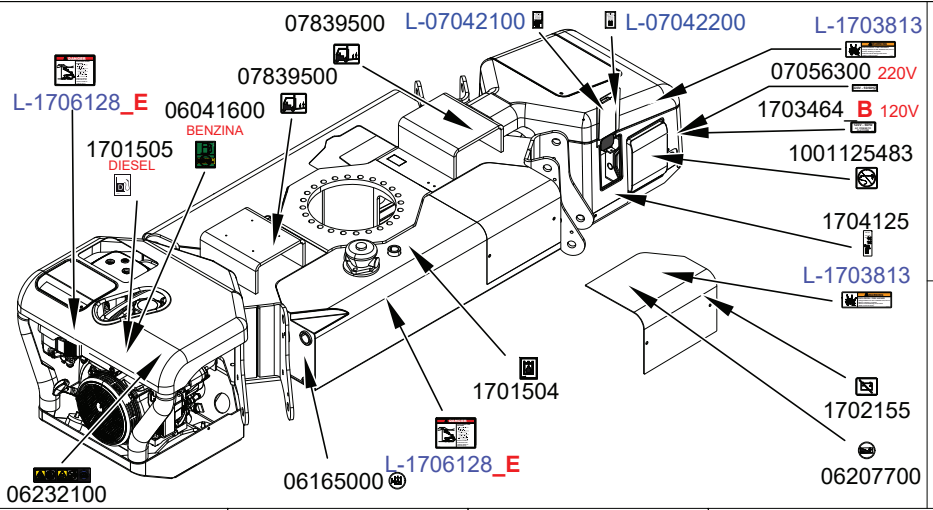
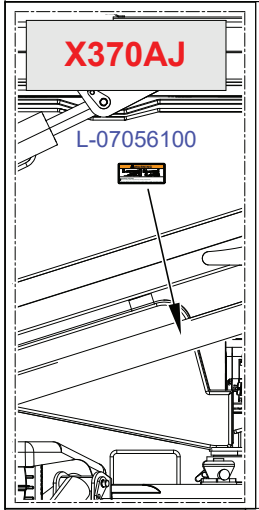
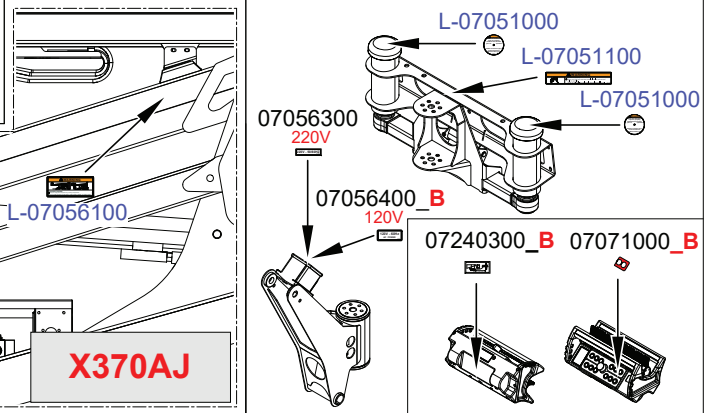
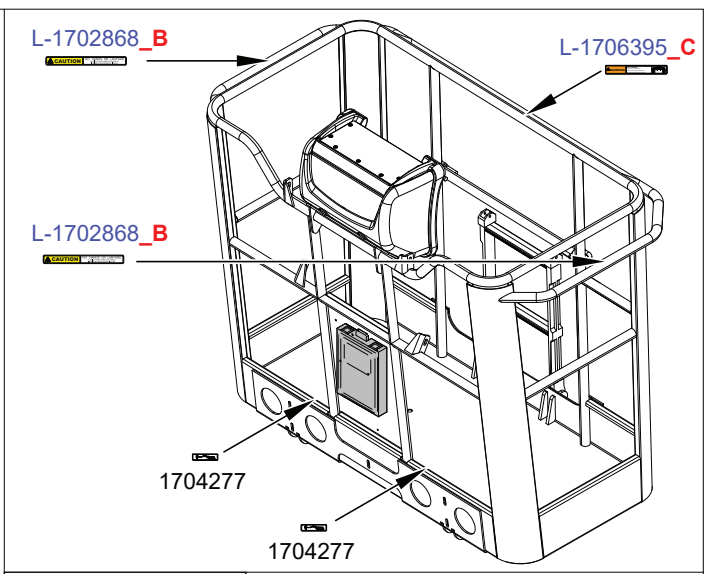
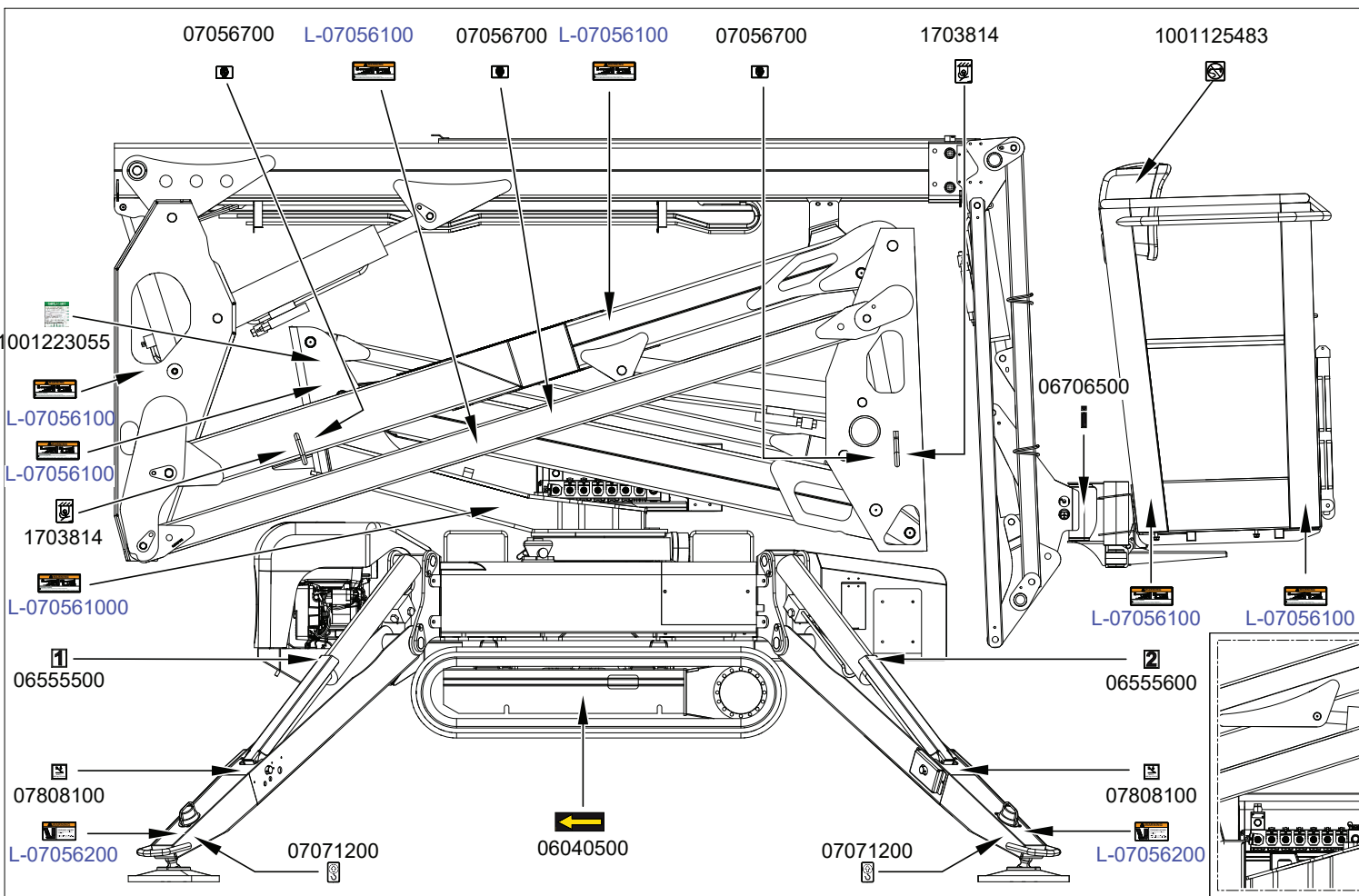

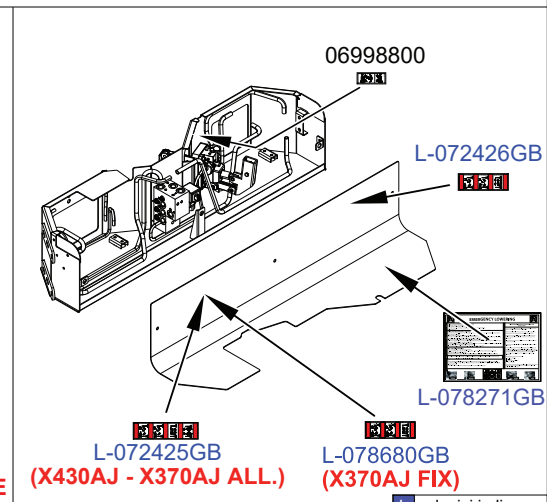
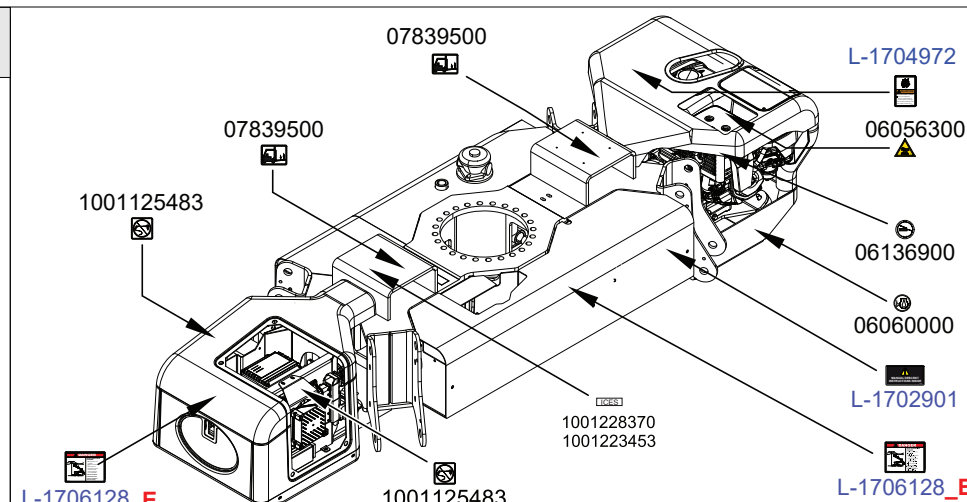
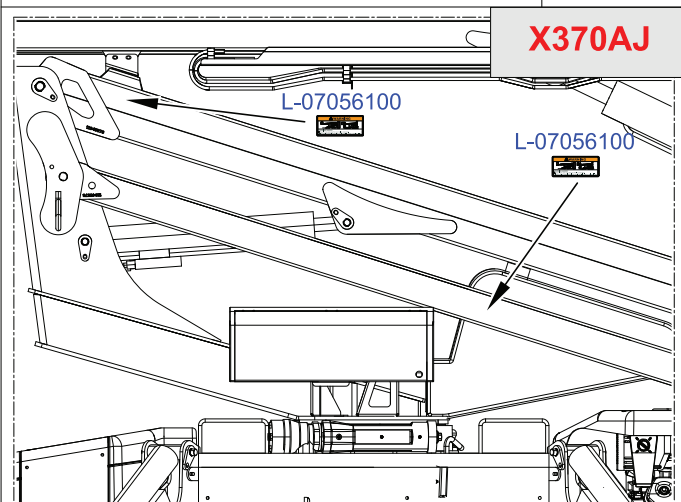
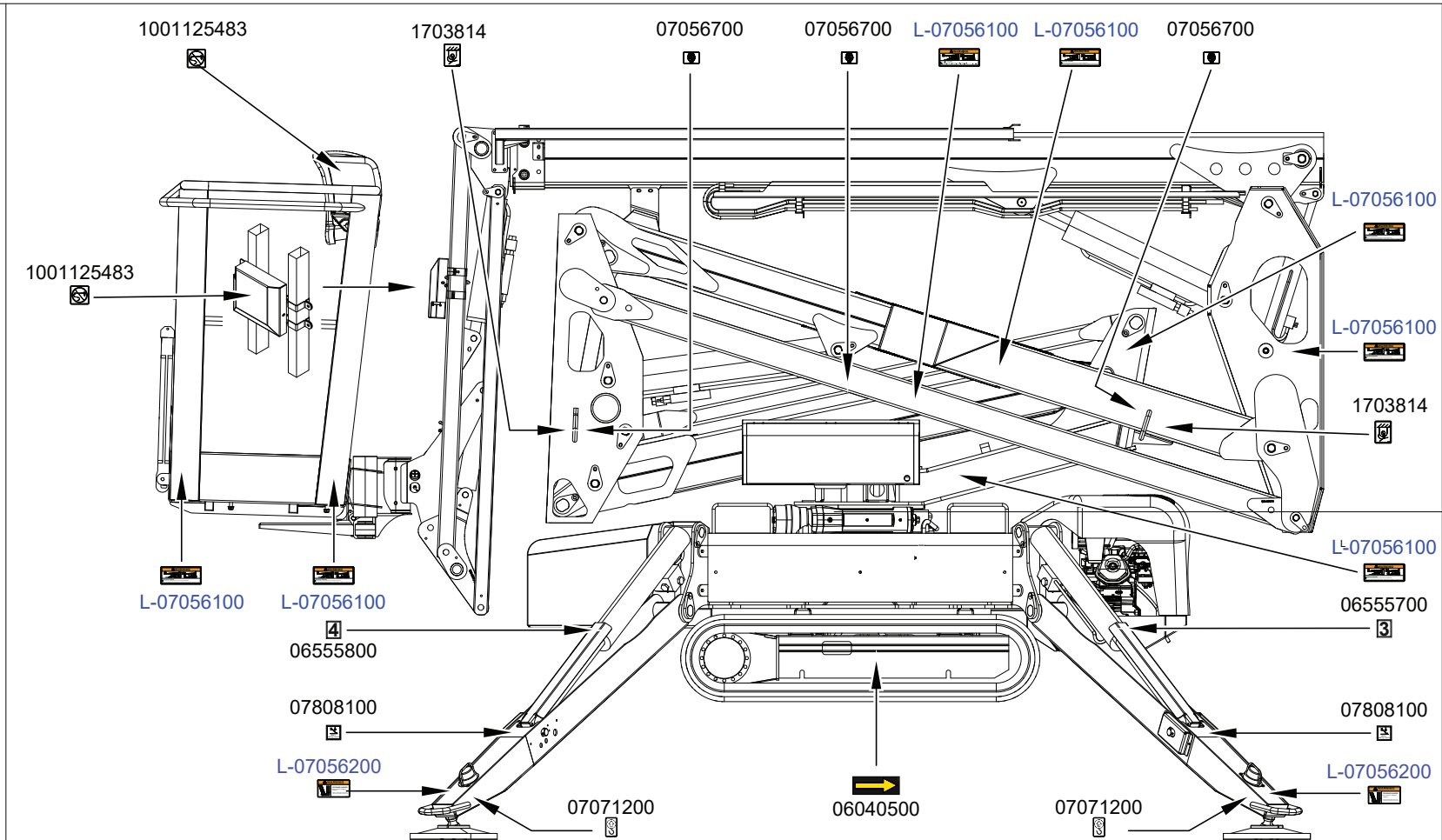
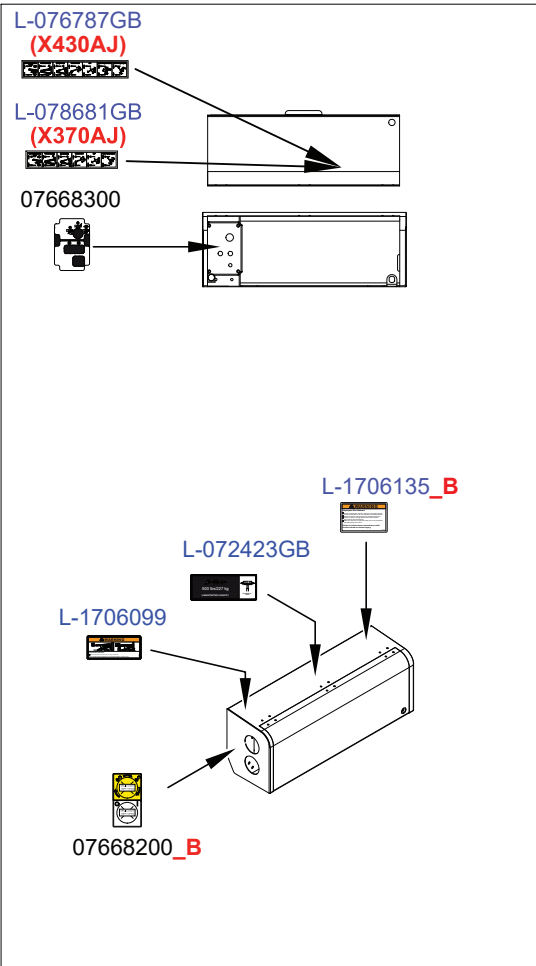

JLG/ANSI - X370AJ / X430AJ ELENCO ADESIVI / LIST STICKERS COD. 17788300

----	COD.	DESCRIZIONE / DESCRIPTION	Q.tà
	06040500	ADESIVO DIREZ. TRASLAZIONE FRECCIA GIALLA SFONDO NERO L=61 X 160	02
	06041600	ADESIVO CARBURANTE BENZINA COLORE VERDE L=60 X 80 MM _MOD_B	01
	06056300	ADESIVO PERICOLO SCOTTATURE TRIANGOLARE SFONDO GIALLO L=60X51 MM	01
	06060000	ADESIVO LIVELLO OLIO MOTORE Ø50 MM	01
	06136900	ADESIVO PUNTI INGRASSAGGIO Ø 55 TESTO NERO - SFONDO BIANCO	01
	06165000	ADESIVO LIVELLO OLIO IDRAULICO Ø50 MM	01
	06207700	ADESIVO BATTERIA POLO POSITIVO POLO NEGATIVO BIANCO Ø50	01
	06232100	ADESIVO JLG CARBURANTE BENZINA L= 101X63,5 (**) _MOD_B	01
	06555500	ADESIVO NR 1 L=50X60 BIANCO	01
	06555600	ADESIVO NR 2 L=50X60 BIANCO	01
	06555700	ADESIVO N° 3 L=50X60 BIANCO	01
	06555800	ADESIVO N° 4 L=50X60 BIANCO	01
	06706500	ADESIVO ALLINEAMENTO CESTO (2 PEZZI) L=16X50+13 MM	01
	06998800	ADESIVO DEVIATORE POMPA MANUALE PIATTAFORMA GL17.80XL L=86X34 MM	01
	07056300	ADESIVO JLG PERICOLO 220V - 50/60HZ L= 75X18,75 MM	02
	07056700	ADESIVO JLG DIVIETO DI SOLLEVAMENTO L=40X54,88 MM	06
	07071000	ADESIVO JLG CLAXON SU PIATTAFORME L=39,3X28,55 MM _MOD_B	01
	07071200	ADESIVO JLG PUNTO DI SOLLEVAMENTO L= 40X66 MM	08
	07240300	ADESIVO DISTANZA 1 METRO SU TELE/RADIO COMANDI L= 75x35 MM _MOD_B	01
	07808100	ADESIVO REAZIONE AL SUOLO STABILIZZATORI X430AJ L= 50X50 MM	04
	07668200	ADESIVO EMERGENCY STOP E BLOCCHETTO ACCENSIONE L=85x160 MM _MOD_B	01
	07668300	ADESIVO SELETTORE SCATOLA COMANDI TERRA / CESTO L=105X155 MM	01
	07839500	ADESIVO SOLLEVAMENTO PIATTAFORMA CON MULETTO - PICCOLO L=65X50 MM	04
	1001125483	ADESIVO JLG VIETATO LAVARE L=63,5X63,5 MM	06

ELENCO ADESIVI IN LINGUA / LIST LANGUAGE STICKERS COD. / CODE 177883GB_177883FR_177883ES_177883PT

JLG

COD.				DESCRIZIONE / DESCRIPTION	Q.tà
177883FR	177883PT	177883ES	177883GB	ADESIVI IN LINGUA PER JLG/ANSI X430AJ - LINGUA INGLESE / FRANCESE / PORTOGHESE / SPAGNOLO	
07115200	07119800		07042100	ADESIVO JLG SISTEMA BYPASS PARTE AEREA - ING L=30X50 (**)	01
07115300	07119900		07042200	ADESIVO JLG SISTEMA BYPASS TRASLAZIONE - ING L= 30X50 (**)	01
07116600	07121200		07051000	ADESIVO JLG ATTENZ.CADUTE - SBLOCCARE SOLO NEI CASI PREVISTI - ING D Ø 60 FORO 4 MM (**)	02
07116700	07121300		07051100_B	ADESIVO JLG PERICOLO CADUTA - RIPRISTINARE I TAPPI - ING L=196,5x35 MM _MOD_B	01
07116800	07121400		07056100	ADESIVO JLG PERICOLO SCHIACCIAMENTO - ING L= 140x60,71 MM	16
07116900	07121500		07056200	ADESIVO JLG ATTACCO SCHIACCIAMENTO ARTO INFERIORE - ING L= 110x60 MM (PRES. STABILIZZAZTORI	04
07117200	07121800		07058600	ADESIVO JLG POSIZIONE STABILIZZATORI X390 - X550 - ING L= 139,7X69,85 MM	01
081081FR	081081PT		081081GB	ADESIVO JLG/ ANSI CARICO MAX IN CESTA X1000AJ - L=196, 85x76,2 MM	02
072425FR	072425PT		072425GB	ADESIVO JLG ANSI PULSANTI DISTRIBUTORI A TERRA LATO SX X500AJ - ING L=194X50 MM	01
072426FR	072426PT		072426GB	ADESIVO JLG ANSI PULSANTI DISTRIBUTORI A TERRA LATO DX X500AJ - ING L=150X50 MM	01
078271FR	078271PT		078271GB	ADESIVO JLG DISCESA DI EMERGENZA X430AJ MOTORE TERMICO E LITHIUM - ING L=290X205 MM	01
076787FR	076787PT		076787GB	ADESIVO JLG ANSI PULSANTI DISTRIBUTORE PARTE AEREA X770AJ - ING L=318X52 MM	01
078680FR	078680PT		078680GB	ADESIVO JLG/ANSI PULSANTI DISTRIBUTORE A TERRA X430AJ LATO SX - ING L=150X50 MM	01
078681FR	078681PT		078681GB	ADESIVO JLG/ANSI PULSANTI DISTRIBUTORE PARTE AEREA X430AJ - ING L=274X52 MM	01
07117800	07122400		1702868_B	ADESIVO JLG PERICOLO SCHIACCIAMENTO MANO - ING L= 241,30X25.40 MM _MOD_B (**)	02
07117900	07122500		1702901	ADESIVO JLG ISTRUZIONI DISCESA EMERGENZA / POMPA MANUALE - ING L=114,3x58,73MM	01
07118200	07122800		1703813	ADESIVO JLG PERICOLO ESPLOSIONE BATTERIE - ING L=149, 25X47,62 MM	02
07892700	07892800		1703464	ADESIVO JLG PERICOLO 120 VOLT 60HZ - ING L= 75x32.68 MM _MOD_B	02
07118300	07122900		1704972_C	ADESIVO JLG PERICOLO ESPLOSIONE - ING L=63,5x92,07 MM _MOD_C	01
08069800	08069800		08069800	ADESIVO JLG ATTENZIONE PROP.65 L=101,6X57,1 MM RIF JLG CODE. 1001231801C	01
07118500	07123100		1706099	ADESIVO JLG PERICOLO SCHIACCIAMENTO - ING L= 161,925X69, 85 MM (A TERRA)	01
07118600	07123200		1706128_E	ADESIVO JLG PERICOLO FOLGORAZIONE - ING L=120,65x91,50 MM _MOD_E	05
07118700	07123300		1706133_C	ADESIVO JLG PERICOLO RIBALTAMENTO - ING L=139,7X68,85 MM _MOD_C	01



AGGIORNATO IL / UPDATED 29/11/2019

**KIT ADESIVI COMMERCIALI PER PIATTAFORMA AEREA /
*STICKERS KIT COMMERCIAL FOR AERIAL PLATFORM***

JLG/ANSI X430AJ

Cod. 17788400

COD. 17788300 *DA USARE CON / FOR USE WITH*
**KIT ADESIVI DI SICUREZZA PER PIATTAFORMA AEREA / STICKER KITS SECURITY AERIAL PLAT-
FORM**

A STABILIZZATORI CHIUSI CENTRARE SUL BRACCIO SIA IN ALTEZZA CHE IN LARGHEZZA IL LOGO JLG LIFT
A CLOSED CENTRALISE REGULATORS ON ARM IS IN HEIGHT TO WIDTH IN THE LOGO JLG LIFT

centrare il logo in altezza e larghezza fra lo spazio rimanente
 center the logo in height and width among the remaining space

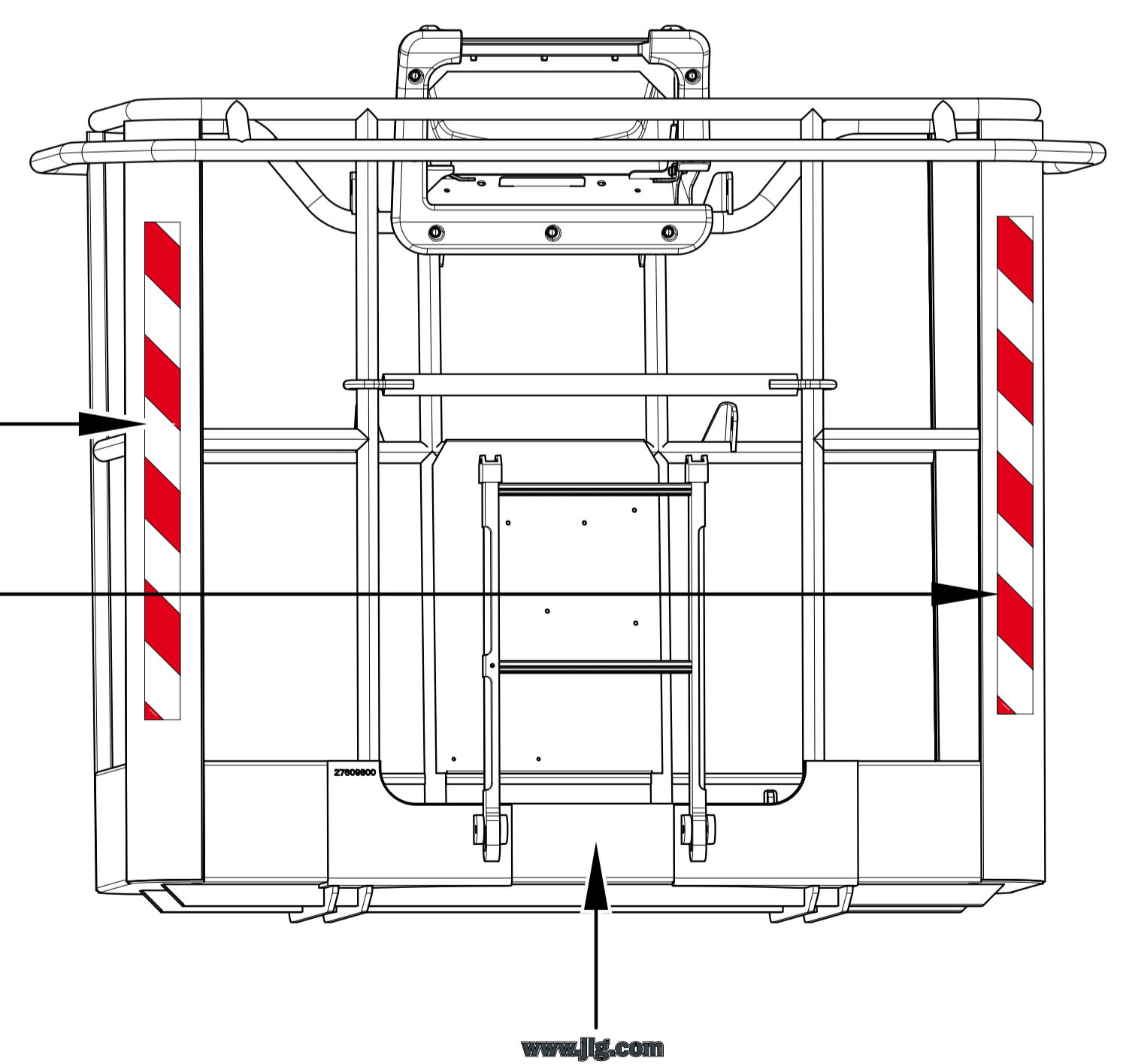
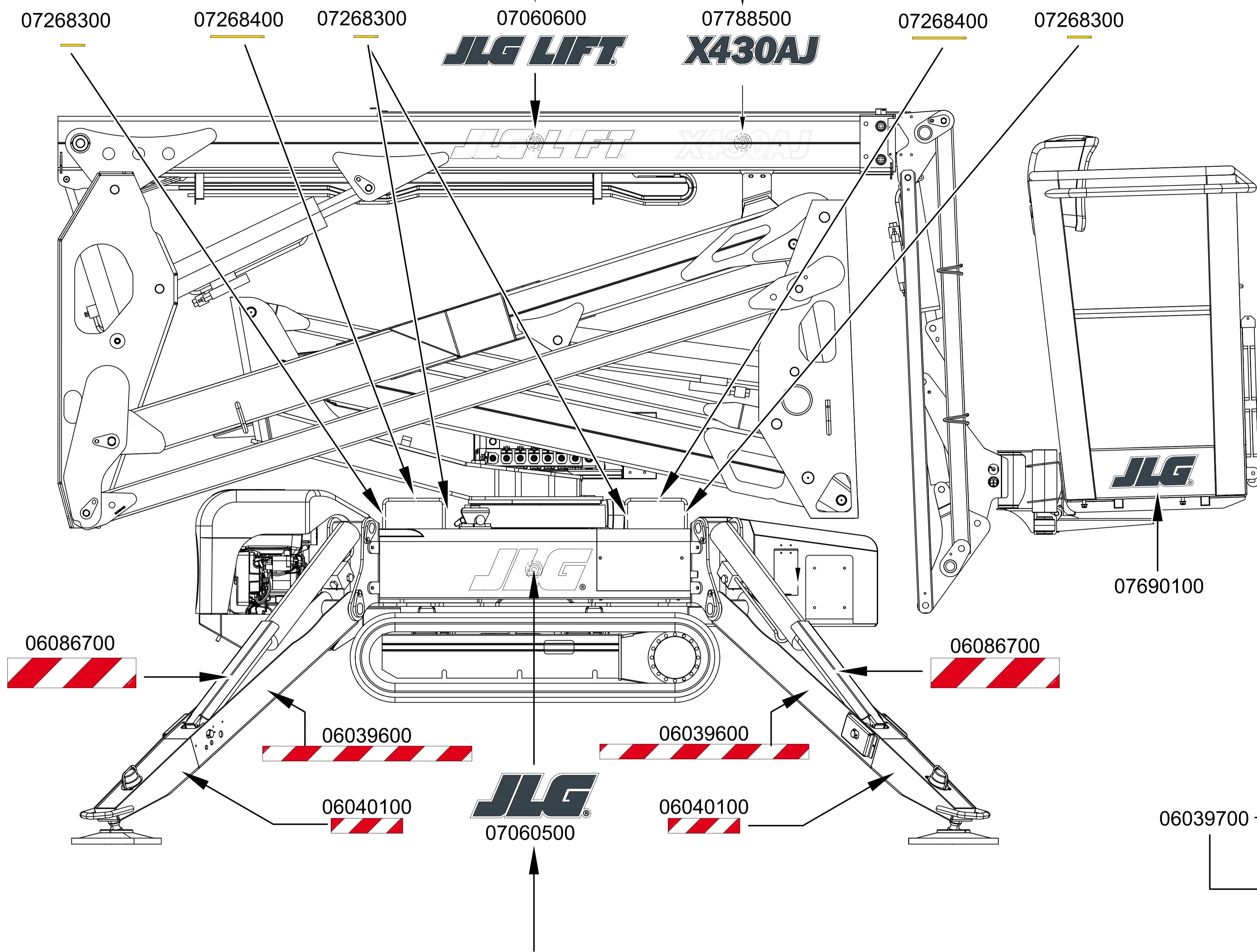

A STABILIZZATORI CHIUSI CENTRARE SUL COPERCHIO SIA IN ALTEZZA CHE IN LARGHEZZA IL LOGO JLG
A CLOSED CENTRALISE REGULATORS ON THE COVER IS IN HEIGHT TO WIDTH IN THE LOGO JLG



AGGIORNATO IL / UPDATED 30/10/2019

KIT ADESIVI CESTO MONOPOSTO E BIPOSTO PER PIATTAFORME AEREE /
BASKET KIT STICKERS SINGLE POSTAND TANDEM FOR PLATFORMS

SERIE/SERIES JLG/CE

X14J • X17J • X19J • X23J
X13JPLUS • X15JPLUS • X17JPLUS • X20JPLUS • X26JPLUS

CON MOTORE TERMICO E LITHIUM / WITH HEAT ENGINE AND LITHIUM

Cod. 17876800

+ kit adesivi portata cesto non inclusi nel codice generale
Sticker kits basket capacity not included in the standard kit

178768X14J / 178768X17J / 178768X19J / 178768X23J
178768X13JP / 178768X15JP / 178768X17JP / 178768X20JP / 178768X26JP

+ kit in lingua non inclusi nel codice generale
language code not included in the standard kit

174164IT / 1174164GB / 174164FR / 174164DE / 174164ES / 174164NL / 174164SW / 174164PT /
174164DA / 174164NO / 174164RU / 174164PL / 174164SL / 174164FI / 174164CE / 174164JA

JLG/CE X13JPLUS • X15JPLUS • X17JPLUS • X20JPLUS • X26JPLUS

JLG/CE 14J • X17J • X19J • X23J

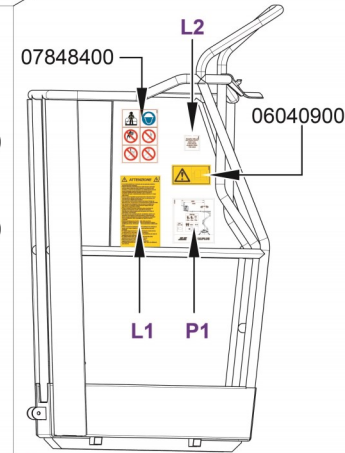
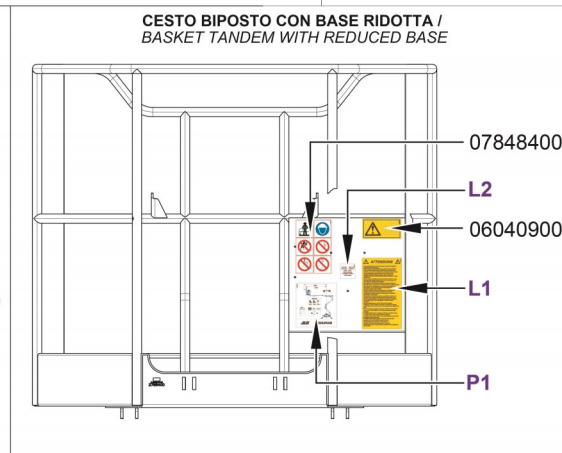
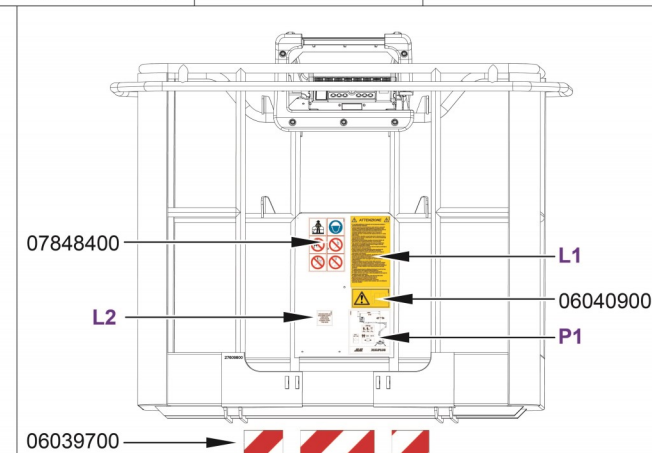
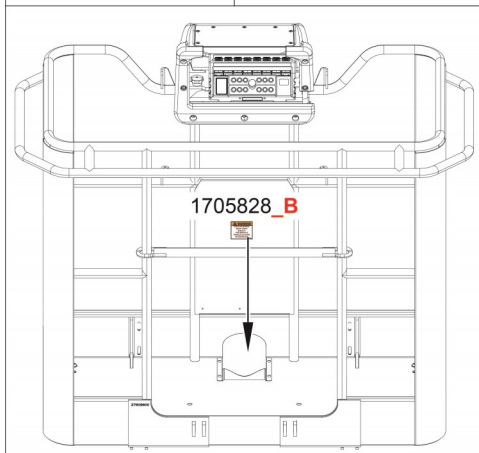
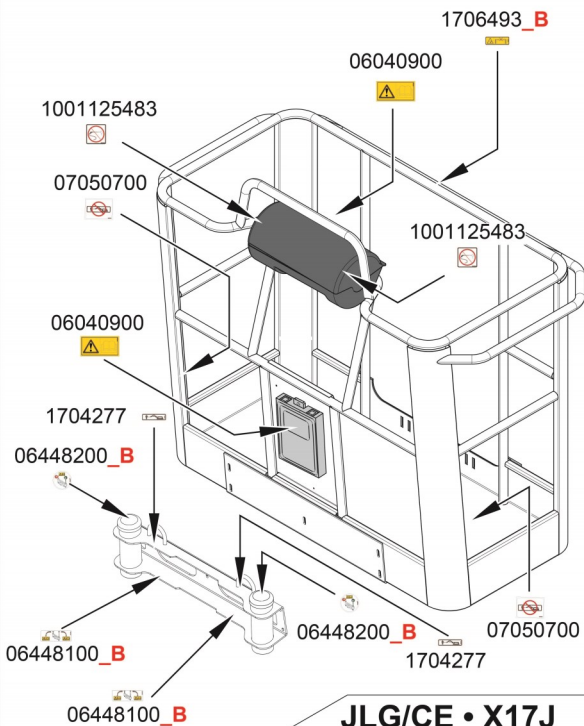
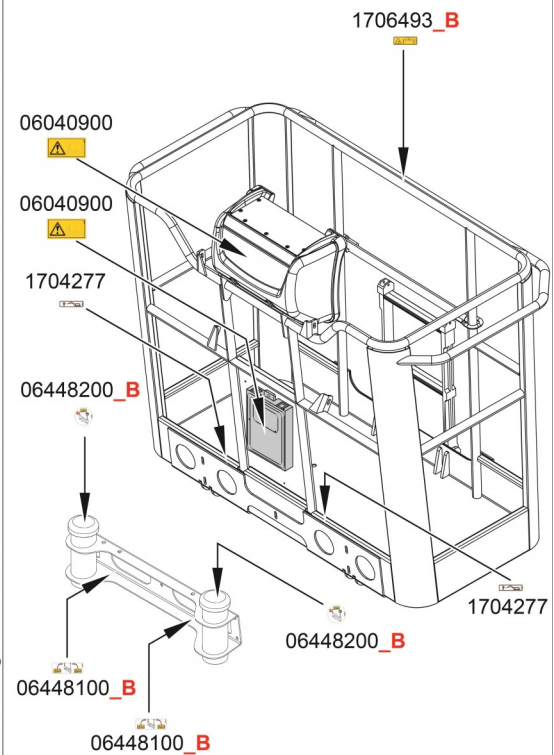
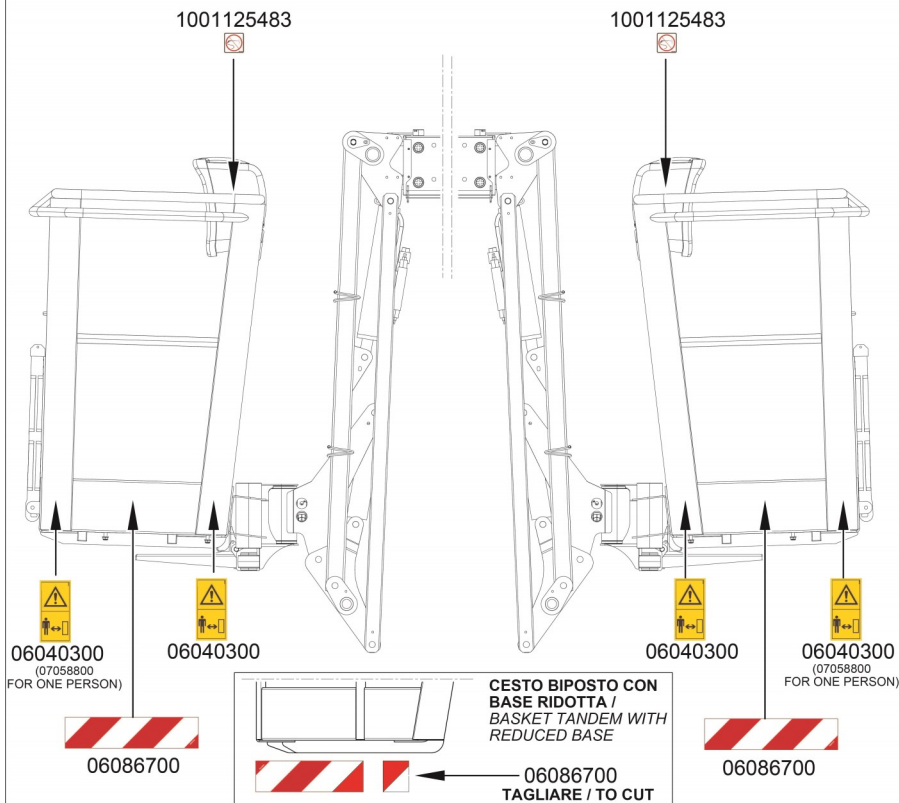

JLG/CE • X17J

KIT ADESIVI CESTO / ADHESIVE KIT BASKET / AUTOCOLLANTS PANIER KIT / AUFKLEBER-KIT BASKET / KIT DE ETIQUETA CESTA / STICKERS KIT DE MAND VAN
X14J_X17J_X19J_X23J ... X13JPLUS_X15JPLUS_X17JPLUS_X20JPLUS_X26JPLUS

SCALA 1:8 COD. 17878600 TAV. 01 A1

P Kit portata cesto L Kit adesivi in lingua

SERIE / SERIES JLG /CE COD. 178768 POSIZIONE ADESIVI PORTATA CESTO /POSITION ADHESIVE**

POS.	COD.	REV.	DESCRIZIONE / DESCRIPTION	Q.tà
P1	178768X14J		KIT ADESIVI PORTATA CESTO X14J CON MOTORE TERMICO E LITHIUM	
	07059400	A	ADESIVO JLG PORTATA CESTO 2 PERSONE X14J L=135X145 MM	01
	07059300	A	ADESIVO JLG PORTATA CESTO 1 PERSONA X14J L=135X145 MM	01
P1	178768X17J		KIT ADESIVI PORTATA CESTO X17J CON MOTORE TERMICO E LITHIUM	
	07059600	A	ADESIVO JLG PORTATA CESTO 2 PERSONE X17J L=135X145 MM	01
	07059500	A	ADESIVO JLG PORTATA CESTO 1 PERSONA X17J L=135X145 MM	01
P1	178768X19J		KIT ADESIVI PORTATA CESTO X19J CON MOTORE TERMICO E LITHIUM	
	07059800	A	ADESIVO JLG PORTATA CESTO 2 PERSONE X19J L=135X145 MM	01
	07059700	A	ADESIVO JLG PORTATA CESTO 1 PERSONA X19J L=135X145 MM	01
P1	178768X23J		KIT ADESIVI PORTATA CESTO X23J CON MOTORE TERMICO E LITHIUM	
	07060000	A	ADESIVO JLG PORTATA CESTO 2 PERSONE X23J L=135X145 MM	01
	07059900	A	ADESIVO JLG PORTATA CESTO 1 PERSONA X23J L=135X145 MM	01
P1	178768X13JP		KIT ADESIVI PORTATA CESTO X13JPLUS CON MOTORE TERMICO E LITHIUM	
	07868200	A	ADESIVO JLG PORTATA CESTO 2 PERSONE X13JPLUS L=135X145 MM	01
	07868400	A	ADESIVO JLG PORTATA CESTO 1 PERSONA X13JPLUS L=135X145 MM	01
P1	178768X15JP		KIT ADESIVI PORTATA CESTO X15JPLUS CON MOTORE TERMICO E LITHIUM	
	07799400	A	ADESIVO JLG PORTATA CESTO 2 PERSONE X15JPLUS L=135X145 MM	01
	07799500	A	ADESIVO JLG PORTATA CESTO 1 PERSONA X15JPLUS L=135X145 MM	01

SERIE / SERIES JLG / CE COD. 178768 POSIZIONE ADESIVI IN LINGUA / POSITION LANGUAGE STICKERS**

POS.	COD.	REV.	DESCRIZIONE / DESCRIPTION	Q.tà
	178768IT		ADESIVI IN LINGUA PER KIT CESTO SERIE JLG/CE X13_X15_X17_X20_X26 - ITALIANO	
L1	06555300	C	ADESIVO USO PIATTAFORMA AEREA CINGOLATA - ITALIANO L=128X230_MOD_C	01
L2	07188100	A	ADESIVO JLG-CE RICARICARE LE BATTERIE DOPO L'USO ALMENO OGNI 3 MESI - ITALIANO L=50x50 MM	01
	178768GB		ADESIVI IN LINGUA PER KIT CESTO SERIE JLG/CE X13_X15_X17_X20_X26 - INGLESE	
L1	06562600	C	ADESIVO USO PIATTAFORMA AEREA CINGOLATA - INGLESE L=128X230_MOD_C	01
L2	07202100	A	ADESIVO JLG-CE RICARICARE LE BATTERIE DOPO L'USO ALMENO OGNI 3 MESI - INGLESE L=50x50 MM	01
	178768FR		ADESIVI IN LINGUA PER KIT CESTO SERIE JLG/CE X13_X15_X17_X20_X26 - FRANCESE	
L1	06562700	C	ADESIVO USO PIATTAFORMA AEREA CINGOLATA - FRANCESE L=128X230_MOD_C	01
L2	07202200	A	ADESIVO JLG-CE RICARICARE LE BATTERIE DOPO L'USO ALMENO OGNI 3 MESI - FRANCESE L=50x50 MM	01
	178768DE		ADESIVI IN LINGUA PER KIT CESTO SERIE JLG/CE X13_X15_X17_X20_X26 - TEDESCO	
L1	06562800	C	ADESIVO USO PIATTAFORMA AEREA CINGOLATA - TEDESCO L=128X230_MOD_C	01
L2	07188200	A	ADESIVO JLG-CE RICARICARE LE BATTERIE DOPO L'USO ALMENO OGNI 3 MESI - TEDESCO L=50x50 MM	01
	178768ES		ADESIVI IN LINGUA PER KIT CESTO SERIE JLG/CE X13_X15_X17_X20_X26 - SPAGNOLO	
L1	06562900	C	ADESIVO USO PIATTAFORMA AEREA CINGOLATA - SPAGNOLO L=128X230_MOD_C	01
L2	07202300	A	ADESIVO JLG-CE RICARICARE LE BATTERIE DOPO L'USO ALMENO OGNI 3 MESI - SPAGNOLO L=50x50 MM	01
	178768NL		ADESIVI IN LINGUA PER KIT CESTO SERIE JLG/CE X13_X15_X17_X20_X26 - OLANDESE	
L1	06563000	C	ADESIVO USO PIATTAFORMA AEREA CINGOLATA - OLANDESE L=128X230_MOD_C	01
L2	07188300	A	ADESIVO JLG-CE RICARICARE LE BATTERIE DOPO L'USO ALMENO OGNI 3 MESI - OLANDESE L=50x50 MM	01

SERIE / SERIES JLG / CE COD. 178768 POSIZIONE ADESIVI IN LINGUA / POSITION LANGUAGE STICKERS**

POS.	COD.	REV.	DESCRIZIONE / DESCRIPTION	Q.tà
	178768SW		ADESIVI IN LINGUA PER KIT CESTO SERIE JLG/CE X13_X15_X17_X20_X26 - SVEDESE	
L1	07137300	C	ADESIVO USO PIATTAFORMA AEREA CINGOLATA - SVEDESE L= 128X230 MM _MOD_C	01
L2	07188400	A	ADESIVO JLG-CE RICARICARE LE BATTERIE DOPO L'USO ALMENO OGNI 3 MESI - SVEDESE L=50x50 MM	01
	178768PT		ADESIVI IN LINGUA PER KIT CESTO SERIE JLG/CE X13_X15_X17_X20_X26 - PORTOGHESE	
L1	06563100	C	ADESIVO USO PIATTAFORMA AEREA CINGOLATA - PORTOGHESE L=128X230 _MOD_C	01
L2	07202400	A	ADESIVO JLG-CE RICARICARE LE BATTERIE DOPO L'USO ALMENO OGNI 3 MESI - PORTOGHESE L=50x50 MM	01
	178768DA		ADESIVI IN LINGUA PER KIT CESTO SERIE JLG/CE X13_X15_X17_X20_X26 - DANESE	
L1	07138100	C	ADESIVO USO PIATTAFORMA AEREA CINGOLATA - DANESE L= 128X230 MM _MOD_C	01
L2	07188500	A	ADESIVO JLG-CE RICARICARE LE BATTERIE DOPO L'USO ALMENO OGNI 3 MESI - DANESE L=50x50 MM	01
	178768NO		ADESIVI IN LINGUA PER KIT CESTO SERIE JLG/CE X13_X15_X17_X20_X26 - NORVEGESE	
L1	07162000	C	ADESIVO USO PIATTAFORMA AEREA CINGOLATA - NORVEGESE L=128X230 MM _MOD_C	01
L2	07188600	A	ADESIVO JLG-CE RICARICARE LE BATTERIE DOPO L'USO ALMENO OGNI 3 MESI - NORVEGESE L=50x50 MM	01
	178768RU		ADESIVI IN LINGUA PER KIT CESTO SERIE JLG/CE X13_X15_X17_X20_X26 - RUSSO	
L1	07514800	A	ADESIVO USO PIATTAFORMA AEREA CINGOLATA - RUSSO L=128X230 MM	01
L2	07910300	A	ADESIVO JLG-CE RICARICARE LE BATTERIE DOPO L'USO ALMENO OGNI 3 MESI - RUSSO L=50x50 MM	01
	178768PL		ADESIVI IN LINGUA PER KIT CESTO SERIE JLG/CE X13_X15_X17_X20_X26 - POLACCO	
L1	07506600	B	ADESIVO USO PIATTAFORMA CINGOLATA LINGUA POLACCO L= 128X230MM _MOD_B	01
L2	07508100	A	ADESIVO JLG-CE RICARICARE LE BATTERIE DOPO L'USO ALMENO OGNI 3 MESI - POL ACCO L=50x50 MM	01

KIT INTEGRAZIONE ADESIVI
CESTO RETTANGOLARE DSE

DECALS KIT INTEGRATION
RECTANGULAR DSE BASKET

18374500

HISTORY REVISION

DATA/DATE	VERSION	MODIFICHE/CHANGES	AUTORE
01/04/2021	1.0	Realizzata nuova versione senza foto. New version without photos.	Masaggia Mattia

LISTA ADESIVI
DECALS LIST

CODE	DESCRIZIONE	QTA'
07058800	ADESIVO PERICOLO MANTENERE LE DISTANZE L=65X130 MM - GIALLO	2,00
08141300	ADESIVO NEW LOGO HINOWA GRAFFIATO H=40mm L=100mm	1,00
08347400	ADESIVO STRISCIA BIANCA E ROSSA H100 X L220 MM	2,00
08347500	ADESIVO STRISCIA BIANCA E ROSSA H100 X L350 MM	2,00
08318500	ADESIVO PRESPAZIATO CESTO DSE NERO	1,00

VEDI
MODELLO
MACCHINA

06040900

07878400

06040400

VEDI
MODELLO
MACCHINA

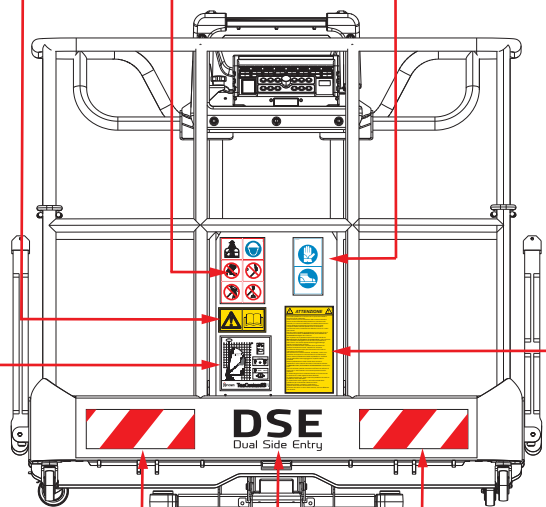

08347500

08318500

08347500

08141300

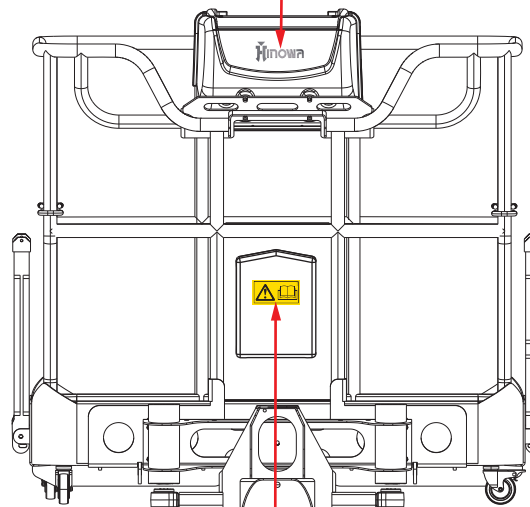

06040900

06448100

06448200



06448200

06448100

1001125483

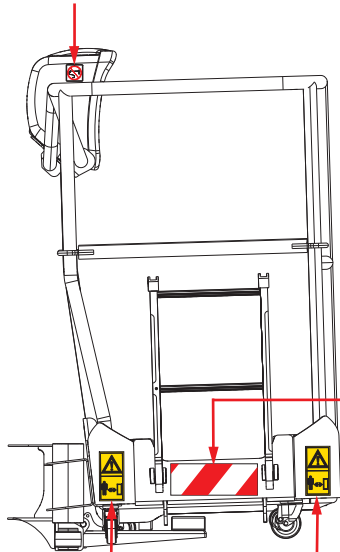

07058800

1001125483

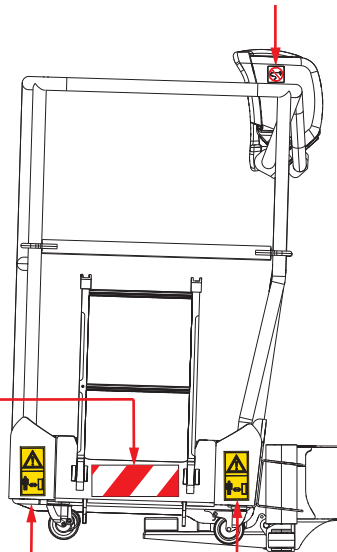

07058800

08347400

1704277

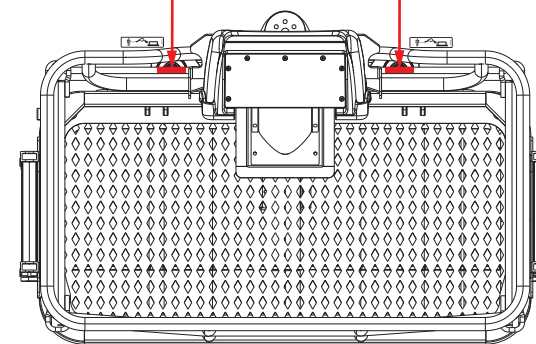

1704277

TABELLA PERNI/SPINE (PINS TABLE)

LOCKING SYSTEM
GHIERA
(LOCKNUTS CODE)
REF. TABLE BELOW

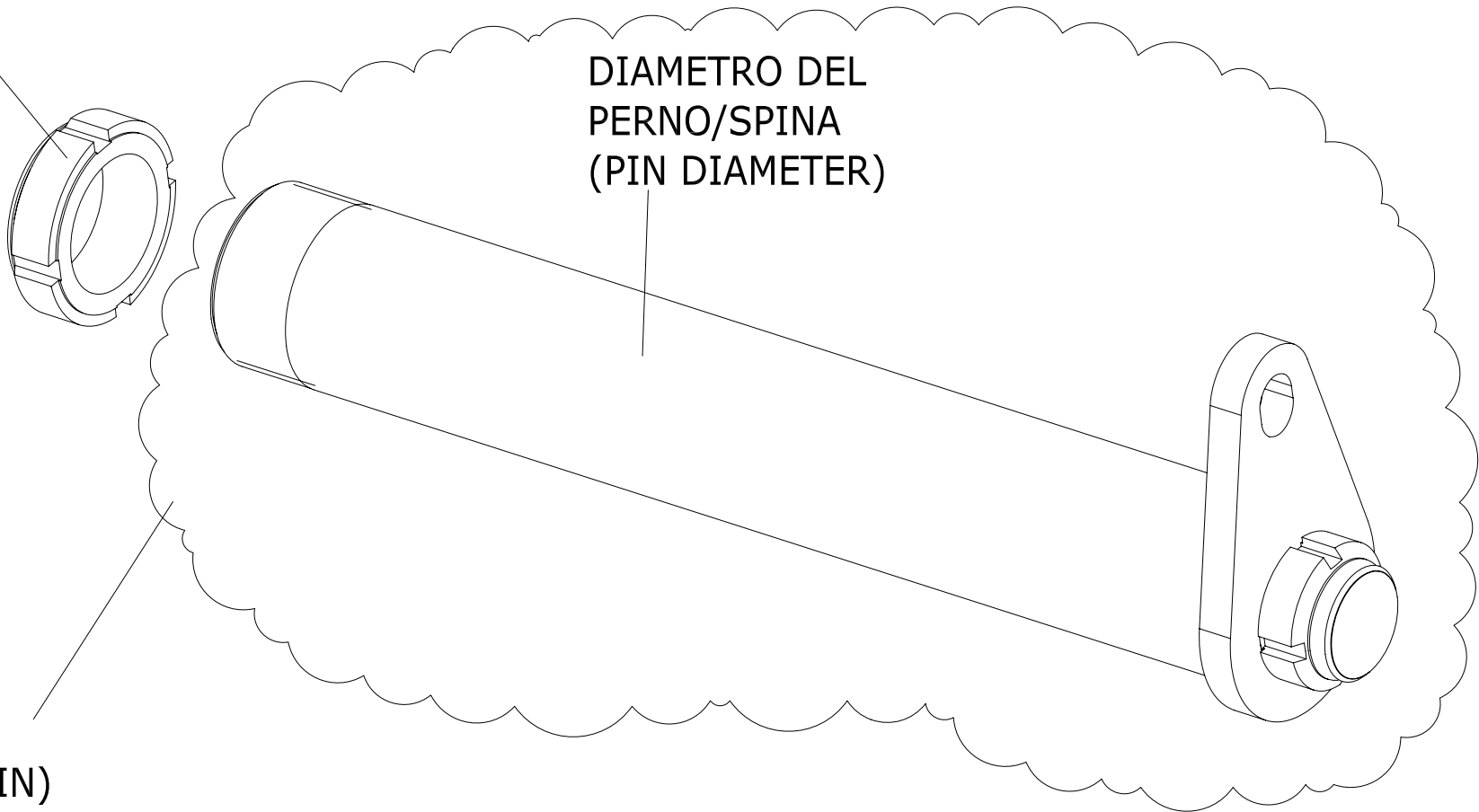





PERNO/SPINA (PIN)





IL CODICE DEL PERNO A RICAMBIO COMPRENDE LA GOCCIA MONTATA E LA GHIERA DI FISSAGGIO DELLA GOCCIA

THE CODE OF A PIN INCLUDES DROP PARTS MOUNTED AND THE LOCK NUT TO FIXING THE DROP, ALL THESE PARTS ARE SHIPPED ALREADY MOUNTED TOGETHER

DIAMETRO DEL PERNO/SPINA mm SISTEMA METRICO (PIN DIAMETER mm METRIC)	GHIERA (LOCKNUTS CODE)	DADO (NUTS CODE)
25	BG4	
30	BG5	
35	BG3	
40	BG2	
45	BG7	
50	BG8	
20 (DIAMETER OF THREADED PART M17 PITCH=1)	BG1	
20 (DIAMETER OF THREADED PART M20 PITCH=1)	BG6	
20 (DIAMETER OF THREADED PART M20 PITCH=1,5)	BG12	

07825700 BUSSOLA PER GHIERE S12GU
 07825800 BUSSOLA PER GHIERE S17GU
 07825900 BUSSOLA PER GHIERE S20GU
 07826000 BUSSOLA PER GHIERE S25GU
 07826100 BUSSOLA PER GHIERE S30GU
 07826200 BUSSOLA PER GHIERE S35GU
 07826300 BUSSOLA PER GHIERE S40GU
 07826400 BUSSOLA PER GHIERE S45GU
 07826500 BUSSOLA PER GHIERE S50GU
 07826600 BUSSOLA PER GHIERE S55GU
 07826700 BUSSOLA PER CHIÈRE S65GU

POS	Codice	U.M.	 Descrizione	 Description	 Designation	 Benennung	 Descripción
BC1	BC000100	NR	COPPIGLIA 4X40	COTTER PIN 4X40	GOUPILLE 4X40	SPLINT 4X40	CLAVIJA 4X40
BC2	BC000200	NR	COPPIGLIA 5X40	COTTER PIN 5X40			
BC3	BC000300	NR	SEEGER ESTERNO Ø20 GEOMET	SEEGER EXTERNAL Ø20 GEOMET			
BC4	BC000400	NR	SEEGER ESTERNO Ø8	SEEGER EXTERNAL Ø8	CIRCLIP	RING	ANILLO
BC5	BC000500	NR	SEEGER ESTERNO Ø25 GEOMET	SEEGER EXTERNAL Ø25 GEOMET	SEEGER CIRCLIP	SEEGERRING	ANILLO DE RETENCIÓN SEEGER
BC6	BC000600	NR	COPPIGLIA 1,8X8	COTTER PIN 1,8X8			
BC7	BC000700	NR	COPPIGLIA 4X55	COTTER PIN 4X55	GOUPILLE 4X55	SPLINT 4X55	CLAVIJA 4X55
BC8	BC000800	NR	SEEGER ESTERNO Ø15	SEEGER EXTERNAL Ø15	CIRCLIP	RING	ANILLO
BC9	BC000900	NR	SEEGER ESTERNO Ø30	SEEGER EXTERNAL Ø30	CIRCLIP	RING	ANILLO
BC11	BC001100	NR	ANELLI ELASTICI X ALBERI (SEEGER) DIN 471 ACC.MOLLE 10 ZINCATA D. BIANCA	SNAP RINGS FOR SHAFTS (SEEGER) DIN 471 ACC. SPRINGS 10 Z WITHE	CIRCLIP	RING	ANILLO
BC12	BC001200	NR	ANELLI ELASTICI X ALBERI (SEEGER) DIN 471 ACC.MOLLE 12 GEO 321A	SNAP RINGS FOR SHAFTS (SEEGER) DIN 471 ACC. SPRINGS 12 GEO 321A	CIRCLIP	RING	ANILLO
BC13	BC001300	NR	ANELLI ELASTICI X FORI (SEEGER) DIN 472 ACC.MOLLE 33 GEO 321A	SNAP RINGS FOR HOLES (SEEGER) DIN 472 ACC. SPRINGS 33 GEO 321A	CIRCLIP	RING	ANILLO
BC14	BC001400	NR	ANELLI ELASTICI X FORI (SEEGER) DIN 472 ACC.MOLLE 62 GEO 321A	SNAP RINGS FOR HOLES (SEEGER) DIN 472 ACC. SPRINGS 62 GEO 321A	CIRCLIP	RING	ANILLO
BC15	BC001500	NR	ANELLI ELASTICI X FORI (SEEGER) DIN 472 ACC.MOLLE 75 GEO 321A	SNAP RINGS FOR HOLES (SEEGER) DIN 472 ACC. SPRINGS 75 GEO 321A	CIRCLIP	RING	ANILLO
BC16	BC001600	NR	COPIGLIA RICOTTA DIN 94 FERRO RICOTTO D 5 X 70 Z.BIANCA	COTTER PIN DIN 94 IRON ANNEALED D 5 X 70 Z. WHITE	CIRCLIP	RING	ANILLO

POS	Codice	U.M.	 Descrizione	 Description	 Designation	 Benennung	 Descripción
BC17	BC001700	NR	COPIGLIA ELASTICA DI SICUREZZA ACC.MOLLE D 2 Z.BIANCA	ELASTIC COTTER PIN ACC. SPRINGS D 2 Z. WHITE	CIRCLIP	RING	ANILLO
BC18	BC001800	NR	ANELLI ELASTICI X ALBERI (SEEGER) DIN 471 ACC.MOLLE 35 GEO 321A	SNAP RINGS FOR SHAFTS (SEEGER) DIN 471 ACC. SPRINGS 35 GEO 321A	CIRCLIP	RING	ANILLO
BC19	BC001900	NR	ANELLI ELASTICI X ALBERI (SEEGER) DIN 471 ACC.MOLLE 70 GEO 321A	SNAP RINGS FOR SHAFTS (SEEGER) DIN 471 ACC. SPRINGS 70 GEO 321A	CIRCLIP	RING	ANILLO
BC20	BC002000	NR	COPIGLIA RICOTTA DIN 94 FERRO RICOTTO D 5 X 50 Z.BIANCA	COTTER PIN DIN 94 IRON ANNEALED D 5 X 50 Z. WHITE	CIRCLIP	RING	ANILLO
BC21	BC002100	NR	ANELLI ELASTICI X FORI (SEEGER) DIN 472 ACC.MOLLE 55 GEO 321A	SNAP RINGS FOR HOLES (SEEGER) DIN 472 ACC. SPRINGS 55 GEO 321A	CIRCLIP	RING	ANILLO
BD1	BD000100	NR	DADO ESAGONALE FLANGIATO LISCIO PG DIN 6923 CL 8 M 14 Z.BIANCA	HEX FLANGE NUT DIN 6923 CL SMOOTH PG 8 M 14 Z. WHITE	ÉCROU HEXAGONAL BRIDÉ LISSE PG DIN 6923 CL 8 M 14 Z.BLANCHE	GEWINDE SECHSKANTMUTTER DIN 6923 CL SMOOTH PG 8 M 14 Z. WEIß	ARANDELA HEXAGONAL ROSCADA LISA DIN 6923 CL 8 M 14 GALVANIZADA BLANCA
BD2	BD000200	NR	DADO ESAGONALE BASSO PG DIN 936 CL 04 M 8 Z.BIANCA	LOW HEX NUT DIN 936 PG 04 M CL 8 Z. WHITE	ÉCROU HEXAGONAL BAS PG DIN 936 CL 04 M 8 GALVANISÉ BLANC	NUTTER	TUERCA
BD3	BD000300	NR	DADO ESAGONALE ALTO PG UNI 5587 CL 8 M 8 Z.BIANCA	HEX NUT HIGH PG UNI 5587 CL 8 M 8 Z. WHITE	ÉCROU HEXAGONAL PG UNI 5587 CL 8 M 8 Z.BLANCHE	HOHE SECHSKANTMUTTER PG UNI 5587 CL 8 M 8 Z. WEIß	ARANDELA ALTA HEXAGONAL UNI 5587 CL 8 M 8 GALVANIZADA BLANCA
BD4	BD000400	NR	DADO ALTO AUTOBLOCCANTE PG DIN 982 CL 8 M 12 Z.BIANCA	HIGH SELF LOCKING NUT DIN 982 PG 12 CL 8 M Z. WHITE	HAUT ÉCROU AUTOBLOQUANT DIN 982 PG 12 CL 8 M Z. BLANCHE	HOHE SELBSTSICHERUNGSMUTTER DIN 982 PG 12 CL 8 M Z. WEIß	ARANDELA ALTA AUTOBLOCANTE DIN 982 CL 8 M 12 GALVANIZADA BLANCA
BD5	BD000500	NR	DADO ALTO AUTOBLOCCANTE PG DIN 982 CL 8 M 8 Z.BIANCA	HIGH SELF LOCKING NUT DIN 982 PG CL 8 M 8 Z. WHITE	HAUT ÉCROU AUTOBLOQUAND DIN 982 PG CL 8 M 8 Z. BLANCHE	HOHE SELBSTSICHERUNGSMUTTER DIN 982 PG CL 8 M 8 Z. WEIß	ARANDELA ALTA AUTOBLOCANTE DIN 982 CL 8 M 8 GALVANIZADA BLANCA
BD6	BD000600	NR	DADO ESAGONALE ALTO PG UNI 5587 CL 8 M 4 Z.BIANCA	HEX NUT HIGH PG UNI 5587 M 4 CL 8 Z. WHITE	ÉCROU HEXAGONAL HAUT PG UNI 5587 CL 8 M 4 GALVANISÉ BLANC	NUTTER	TUERCA

POS	Codice	U.M.	 Descrizione	 Description	 Designation	 Benennung	 Descripción
BD7	BD000700	NR	DADO ESAGONALE BASSO PG DIN 936 CL 04 M 6 Z.BIANCA	LOW HEX NUT DIN 936 PG 6 CL 04 M Z. WHITE	ÉCROU BAS HEXAGONAL DIN 936 PG 6 CL 04 M Z. BLANCHE	NIEDRIGE SECHSKANTMUTTER DIN 936 PG 6 CL 04 M Z. WEIß	ARANDELA BAJA HEXAGONAL DIN 936 CL 04 M 6 GALVANIZADA BLANCA
BD8	BD000800	NR	DADO BASSO AUTOBLOCCANTE PG DIN 985 CL 8 M 6 Z.BIANCA	LOW SELF-LOCKING NUT DIN 985 PG 6 CL 8 M Z. WHITE	ÉCROU BAS AUTOBLOQUANT DIN 985 PG 6 CL 8 M Z. BLANCHE	NIEDRIGE SELBSTSICHERUNGSMUTTER DIN 985 PG 6 CL 8 M Z. WEIß	ARANDELA BAJA AUTOBLOCANTE DIN 985 CL 8 M 6 GALVANIZADA BLANCA
BD9	BD000900	NR	DADO ALTO AUTOBLOCCANTE PG DIN 982 CL 8 M 6 Z.BIANCA	HIGH SELF LOCKING NUT DIN 982 PG CL 8 M6 Z. WHITE	ÉCROU HAUT AUTOBLOQUANT NUT DIN 982 PG CL 8 M6 Z. BLANCHE	SELBSTSICHERUNGSMUTTER DIN 982 PG CL 8 M6 Z. WEIß	TUERCA AUTOBLOCANTE ALTA DIN 982 CL 8 M 6 GALVANIZADA BLANCA
BD10	BD001000	NR	DADO BASSO AUTOBLOCCANTE PG DIN 985 CL 8 M 5 Z.BIANCA	LOW SELF-LOCKING NUT DIN 985 PG CL 8 M5 Z. WHITE	ÉCROU BAS AUTOBLOQUANT PG DIN 985 CL 8 M 5 GALVANISÉ BLANC	NUTTER	TUERCA
BD11	BD001100	NR	DADO ALTO AUTOBLOCCANTE PG DIN 982 CL 8 M 5 Z.BIANCA	HIGH SELF LOCKING NUT DIN 982 PG CL 8 M5 Z. WHITE	ÉCROU HAUT AUTOBLOQUANT PG DIN 982 CL 8 M 5 Z.BLANCHE	SELBSTSICHERUNGSMUTTER DIN 982 PG CL 8 M5 Z. WEIß	TUERCA AUTOBLOCANTE ALTA PG DIN 982 CL 8 M 5 GALVANIZADA BLANCA
BD12	BD001200	NR	DADO ALTO AUTOBLOCCANTE PG DIN 982 CL 8 M 4 Z.BIANCA	HIGH SELF LOCKING NUT DIN 982 PG CL 8 M4 Z. WHITE	ÉCROU HAUT AUTOBLOQUANT PG DIN 982 CL 8 M 4 Z.BLANCHE	SELBSTSICHERUNGSMUTTER DIN 982 PG CL 8 M4 Z. WEIß	TUERCA ALTA AUTOBLOCANTE PG DIN 982 CL 8 M 4 GALVANIZADO BLANCA
BD13	BD001300	NR	DADO ALTO AUTOBLOCCANTE PG DIN 982 CL 8 M 3 Z.BIANCA	HIGH SELF LOCKING NUT DIN 982 PG CL 8 M3 Z. WHITE	ÉCROU HAUT AUTOBLOQUANT PG DIN 982 CL 8 M 3 GALVANISÉ BLANC	NUTTER	TUERCA
BD14	BD001400	NR	DADO ALTO AUTOBLOCCANTE PF DIN 982 CL 8 M 20 X 1,5 Z.BIANCA	HIGH SELF LOCKING NUT DIN 982 PF CL 8 M 20 X 1.5 Z WHITE	ÉCROU HAUT AUTOBLOQUANT PF DIN 982 CL 8 M 20 X 1,5 Z.BLANCHE	SELBSTSICHERUNGSMUTTER DIN 982 PF CL 8 M 20 X 1.5 Z WEIß	TUERCA AUTOBLOCANTE ALTA DIN 982 CL 8 M 20 X 1,5 GALVANIZADA BLANCA
BD15	BD001500	NR	DADO ALTO AUTOBLOCCANTE PG DIN 982 CL 8 M 10 Z.BIANCA	HIGH SELF LOCKING NUT DIN 982 PG CL 8 M10 Z. WHITE	ÉCROU HAUT AUTOBLOQUANT DIN 982 PG CL 8 M10 Z. BLANCHE	SELBSTSICHERUNGSMUTTER DIN 982 PG CL 8 M10 Z. WEIß	TUERCA AUTOBLOCANTE ALTA DIN 982 CL 8 M 10 GALVANIZADA BLANCA
BD16	BD001600	NR	DADO ESAGONALE ALTO PG UNI 5587 CL 8 M 3 Z.BIANCA	HEX NUT HIGH PG UNI 5587 CL 8 M3 Z. WHITE	ÉCROU HEXAGONAL HAUT PG UNI 5587 CL 8 M 3 GALVANISÉ BLANC	NUTTER	TUERCA
BD17	BD001700	NR	DADO BASSO AUTOBLOCCANTE PG DIN 985 CL 8 M 8 Z.BIANCA	LOW SELF-LOCKING NUT DIN 985 PG CL 8 M8 Z. WHITE	ÉCROU BAS AUTOBLOQUANT PG DIN 985 CL 8 M 8 Z.BLANCHE	SELBSTSICHERUNGSMUTTER DIN 985 PG CL 8 M8 Z. WEIß	TUERCA BAJA AUTOBLOCANTE DIN 985 CL 8 M 8 GALVANIZADA BLANCA

POS	Codice	U.M.	 Descrizione	 Description	 Designation	 Benennung	 Descripción
BD18	BD001800	NR	DADO ALTO AUTOBLOCCANTE PG DIN 982 CL 8 M 16 Z.BIANCA	HIGH SELF LOCKING NUT DIN 982 PG CL 8 M16 Z. WHITE	ÉCROU AUTOBLOQUANT PG DIN 982 CL 8 M 16 GALVANISÉ BLANC	NUTTER	TUERCA
BD22	BD002200	NR	DADO ALTO AUTOBLOCCANTE PG DIN 982 CL 8 M 14 Z.BIANCA	HEX FLANGE NUT DIN 982 CL 8 M 14 Z. WHITE	ÉCROU HAUT AUTOBLOQUANT PG DIN 982 CL 8 M 14 Z.BLANCHE	SELBSTSICHERUNGSMUTTER DIN 982 CL 8 M 14 Z. WEIß	TUERCA ALTA AUTOBLOCANTE 982 CL 8 M 14 GALVANIZADA BLANCA
BD23	BD002300	NR	DADO BASSO AUTOBLOCCANTE PG DIN 985 CL 8 M 10 Z.BIANCA	LOW SELF-LOCKING NUT DIN 985 PG CL 8 M 10 Z. WHITE	ÉCROU BAS AUTOBLAQUANT PG DIN 985 CL 8 M 10 GALVANISÉ BLANC	NUTTER	TUERCA
BD24	BD002400	NR	DADO ALTO AUTOBLOCCANTE PG DIN 982 CL 8 M 24 Z.BIANCA	HIGH SELF LOCKING NUT DIN 982 PG CL 8 M24 Z. WHITE	ÉCROU HAUT AUTOBLOQUANT PG DIN 982 CL 8 M 24 GALVANISÉ BLANC	NUTTER	TUERCA
BD25	BD002500	NR	DADO ESAGONALE ALTO PG UNI 5587 CL 8 M 6 Z.BIANCA	HEX NUT HIGH PG UNI 5587 M 6 CL 8 Z. WHITE	ÉCROU HEXAGONAL HAUT PG UNI 5587 CL 8 M 6 Z.BLANCHE	SECHSKANTMUTTER PG UNI 5587 M 6 CL 8 Z. WEIß	TUERCA ALTA HEXAGONAL UNI 5587 CL 8 M 6 GALVANIZADA BLANCA
BD26	BD002600	NR	DADO ESAGONALE ALTO PG UNI 5587 CL 10 M 10 Z.BIANCA	HEX NUT HIGH PG UNI 5587 M 10 CL 10 Z. WHITE	ÉCROU HEXAGONAL HAUT PG UNI 5587 CL 10 M 10 Z.BLANCHE	SECHSKANTMUTTER PG UNI 5587 M 10 CL 10 Z. WEIß	TUERCA ALTA HEXAGONAL UNI 5587 CL 10 M 10 GALVANIZADA BLANCA
BD27	BD002700	NR	DADO ALTO AUTOBLOCCANTE PG DIN 982 CL 8 M 18 Z.BIANCA	HIGH SELF LOCKING NUT DIN 982 PG CL 8 M18 Z. WHITE	ÉCROU HAUT AUTOBLOQUANT PG DIN 982 CL 8 M 18 Z.BLANCHE	SELBSTSICHERUNGSMUTTER DIN 982 PG CL 8 M18 Z. WEIß	TUERCA ALTA AUTOBLOCANTE DIN 982 CL 8 M 18 GALVANIZADA BLANCA
BD28	BD002800	NR	DADO BASSO AUTOBLOCCANTE PG DIN 985 CL 8 M 16 Z.BIANCA	LOW SELF-LOCKING NUT DIN 985 PG CL 8 M 16 Z. WHITE	ÉCROU BAS AUTOBLOQUANT PG DIN 985 CL 8 M 16 GALVANISÉ BLANC	NIEDRIGE SELBSTSICHERUNGSMUTTER DIN 985 PG CL 8 M 16 Z. WEIß	TUERCA BAJA AUTOBLOCANTE PG DIN 985 CL 8 M 16 GALVANIZADA BLANCA
BD29	BD002900	NR	DADO ESAGONALE ALTO PG UNI 5587 CL 8 M 5 Z.BIANCA	HEX NUT HIGH PG UNI 5587 M 5 CL 8 Z. WHITE	ÉCROU HEXAGONAL HAUT PG UNI 5587 CL 8 M 5 Z.BLANCHE	SECHSKANTMUTTER PG UNI 5587 M 5 CL 8 Z. WEIß	TUERCA ALTA HEXAGONAL UNI 5587 CL 8 M 5 GALVANIZADA BLANCA
BD30	BD003000	NR	DADO ESAGONALE ALTO PG UNI 5587 CL 12 M 5 Z.BIANCA	HEX NUT HIGH PG UNI 5587 M 5 CL 12 Z. WHITE	ÉCROU HEXAGONAL HAUT PG UNI 5587 CL 12 M 5 Z.BLANCHE	SECHSKANTMUTTER PG UNI 5587 M 5 CL 12 Z. WEIß	TUERCA ALTA HEXAGONAL UNI 5587 CL 12 M 5 GALVANIZADA BLANCA
BD31	BD003100	NR	DADO ESAGONALE ALTO PG UNI 5587 CL 16 M 5 Z.BIANCA	HEX NUT HIGH PG UNI 5587 M 5 CL 16 Z. WHITE	ÉCROU HEXAGONAL HAUT PG UNI 5587 CL 16 M 5 Z.BLANCHE	SECHSKANTMUTTER PG UNI 5587 M 5 CL 16 Z. WEIß	TUERCA ALTA HEXAGONAL UNI 5587 CL 16 M 5 GALVANIZADA BLANCA

POS	Codice	U.M.	 Descrizione	 Description	 Designation	 Benennung	 Descripción
BD32	BD003200	NR	DADO ALTO AUTOBLOCCANTE PG DIN 982 CL 8 M 20 Z.BIANCA	HIGH SELF LOCKING NUT DIN 982 PG CL 8 M20 Z. WHITE	ÉCROU HAUT AUTOBLOQUANT PG DIN 982 CL 8 M 20 GALVANISÉ BLANC	NUTTER	TUERCA
BD33	BD003300	NR	DADO BASSO AUTOBLOCCANTE PG DIN 985 CL 8 M 12 Z.BIANCA	LOW SELF-LOCKING NUT DIN 985 PG CL 8 M 12 Z. WHITE	ÉCROU BAS AUTOBLAQUANT PG DIN 985 CL 8 M 12 GALVANISÉ BLANC	NUTTER	TUERCA
BD35	BD003500	NR	DADO ESAGONALE ALTO PG UNI 5587 CL 10 M 12 Z.BIANCA	HEXAGON NUT ALTO UNI 5587 CL 10 M 12 Z. WHITE	ÉCROU	NUTTER	TUERCA
BD36	BD003600	NR	DADO ESAGONALE ALTO PG UNI 5587 CL 10 M 16 Z.BIANCA	HEXAGON NUT ALTO UNI 5587 CL 10 M 16 Z. WHITE	ÉCROU	NUTTER	TUERCA
BD37	BD003700	NR	DADO ESAGONALE ALTO PG UNI 5587 CL 8 M 20 Z.BIANCA	HEXAGON NUT ALTO UNI 5587 CL 8 M 20 Z. WHITE	ÉCROU	NUTTER	TUERCA
BD39	BD003900	NR	DADO ALTO AUTOBLOCCANTE PG DIN 982 CL 8 M 22 Z.BIANCA	HIGH SELF-LOCKING NUT DIN 982 CL 8 M 22 Z. WHITE	ÉCROU	NUTTER	TUERCA
BD40	BD004000	NR	DADO BASSO AUTOBLOCCANTE PG DIN 985 CL 8 M 14 Z.BIANCA	LOW SELF-LOCKING NUT DIN 985 CL 8 M 14 Z. WHITE	ÉCROU	NUTTER	TUERCA
BD41	BD004100	NR	DADO ESAGONALE MEDIO PF DIN 934 CL 10 M 16 X 1,5 Z.BIANCA	MEDIUM HEXAGONAL NUT PF DIN 934 CL 10 M 16 X 1.5 Z.BIANCA	ÉCROU HEXAGONAL	NUTTER	TUERCA
BD42	BD004200	NR	DADO ALTO PG DIN 982 CL 8 M 24 Z.BIANCA	HIGH NUT DIN 982 PG CL 8 M24 Z. WHITE	ÉCROU PG DIN 982 CL 8 M 24 GALVANISÉ BLANC	NUTTER	TUERCA
BD45	BD004500	NR	DADO ESAGONALE BASSO MB DIN439 INOX A2 M10 X 1	LOW NUT DIN439 INOX MB M10 X 1	ÉCROU BAS DIN439 INOX MB M10 X 1	NUTTER	TUERCA
BD46	BD004600	NR	DADO ALTO AUTOBLOCCANTE PG DIN 982 INOX A2 M4	NUT PG DIN 982 INOX A2 M4	ÉCROU PG DIN 982 INOX A2 M4	NUTTER	TUERCA
BG1	BG000100	NR	GHIERA AUTOBLOCCANTE GN CL 6 GN 3 D. 17 X 1 Z.BIANCA	SELF-LOCKING NUT GN GN 3 CL 6 D. 17 X 1 Z. WHITE			
BG2	BG000200	NR	GHIERA AUTOBLOCCANTE PESANTE CL 6 GUP 40 X 1,5 Z.BIANCA	SELF-LOCKING NUT HEAVY CL 6 GUP 40 X 1.5 Z WHITE			







Viteria



Fasteners







POS	Codice	U.M.	Descrizione	Description	Designation	Benennung	Descripción
BG3	BG000300	NR	GHIERA AUTOBLOCCANTE PESANTE CL 6 GUP 35 X 1,5 Z.BIANCA	SELF-LOCKING NUT HEAVY CL 6 GUP 35 X 1.5 Z WHITE			
BG4	BG000400	NR	GHIERA AUTOBLOCCANTE PESANTE CL 6 GUP 25 X 1,5 Z.BIANCA	SELF-LOCKING NUT HEAVY CL 6 GUP 25 X 1.5 Z WHITE			
BG5	BG000500	NR	GHIERA AUTOBLOCCANTE PESANTE CL 6 GUP 30 X 1,5 Z.BIANCA	SELF-LOCKING NUT HEAVY CL 6 GUP 30 X 1.5 Z WHITE	BAGUE AUTOBLOQUANT LOURDE CL 6 GUP 30 X 1,5 Z.BLANCHE	SELBSTSICHERUNGSNUTMUTTER CL 6 GUP 30 X 1.5 Z WEIß	CASQUILLO AUTOBLOCANTE CL 6 GUP 30 X 1,5 GALVANIZADO BLANCO
BG6	BG000600	NR	GHIERA AUTOBLOCCANTE PESANTE CL 6 GUP 20 X 1 Z.BIANCA	SELF-LOCKING NUT HEAVY CL 6 GUP 20 X 1 Z. WHITE	BAGUE AUTOBLOQUANTE CL 6 GUP 20 X 1 Z.BLANCHE	SELBSTSICHERUNGSNUTMUTTER CL 6 GUP 20 X 1 Z. WEIß	CASQUILLO AUTOBLOCANTE CL 6 GUP 20 X 1 GALVANIZADO BLANCO
BG7	BG000700	NR	GHIERA AUTOBLOCCANTE GN CL 6 GN 3 D. 45 X 1,5 Z.BIANCA	NUT	BAGUE	NUTMUTTER	TUERCA
BG8	BG000800	NR	GHIERA AUTOBLOCCANTE GN CL 6 GN 3 D. 50 X 1,5 Z.BIANCA	NUT	BAGUE	NUTMUTTER	TUERCA
BG9	BG000900	NR	GHIERA AUTOBLOCCANTE GN CL 6 GN 3 D. 20 X 1,5 Z.BIANCA	NUT	BAGUE	NUTMUTTER	TUERCA
BG10	BG001000	NR	GHIERA AUTOBLOCCANTE RIBASSATA CL 6 GUK 25 X 1,5 Z.BIANCA	SELF-LOCKING NUT LOWERED CL 6 GUK 25 X 1.5 Z.BIANCA	BAGUE	NUTMUTTER	TUERCA
BG11	BG001100	NR	GHIERA AUTOBLOCCANTE RIBASSATA CL 6 GUK 20 X 1 Z.BIANCA	SELF-LOCKING NUT LOWERED CL 6 GUK 20 X 1 Z.BIANCA	BAGUE	NUTMUTTER	TUERCA
BG12	BG001200	NR	GHIERA AUTOBLOCCANTE RIBASSATA CL 6 GUA 20 X 1.5 Z.BIANCA	SELF-LOCKING NUT LOWERED CL 6 GUA 20 X 1.5 Z.BIANCA	BAGUE	NUTMUTTER	TUERCA
BG13	BG001300	NR	GHIERA AUTOBLOCCANTE RIBASSATA CL 6 GUK 30 X 1.5 Z.BIANCA	SELF-LOCKING NUT LOWERED CL 6 GUK 30 X 1.5 Z.BIANCA	BAGUE	NUTMUTTER	TUERCA
BG14	BG001400	NR	GHIERA AUTOBLOCCANTE RIBASSATA CL 6 GUK 45 X 1.5 Z.BIANCA	SELF-LOCKING NUT LOWERED CL 6 GUK 45 X 1.5 Z.BIANCA	BAGUE	NUTMUTTER	TUERCA





POS	Codice	U.M.	 Descrizione	 Description	 Designation	 Benennung	 Descripción
BG15	BG001500	NR	GHIERA AUTOBLOCCANTE RIBASSATA CL 6 GUK 50 X 1.5 Z.BIANCA	SELF-LOCKING NUT LOWERED CL 6 GUK 50 X 1.5 Z.BIANCA	BAGUE	NUTMUTTER	TUERCA
BG16	BG001600	NR	GHIERA AUTOBLOCCANTE RIBASSATA CL 6 GUK 55 X 1.5 Z.BIANCA	SELF-LOCKING NUT LOWERED CL 6 GUK 55 X 1.5 Z.BIANCA	BAGUE	NUTMUTTER	TUERCA
BG17	BG001700	NR	GHIERA AUTOBLOCCANTE GN CL 6 GN 1 D. 12 X 1 Z.BIANCA	SELF-LOCKING NUT GN CL 6 GN 1 D. 12 X 1 Z. WHITE	BAGUE	NUTMUTTER	TUERCA
BG18	BG001800	NR	GHIERA AUTOBLOCCANTE GN CL 6 GN 3 D. 65 X 2 Z.BIANCA	NUT	BAGUE	NUTMUTTER	TUERCA
BI1	BI000100	NR	INSERTO ESAGONALE M6	INSERT HEX M6			
BI2	BI000200	NR	INSERTO ESAGONALE M5	INSERT HEX M5			
BI3	BI000300	NR	INSERTO CILINDRICO M4	INSERT M4			
BI4	BI000400	NR	INSERTO CILINDRICO M6	INSERT M6			
BI5	BI000500	NR	INSERTO ESAGONALE M8	INSERT HEX M8			
BI6	BI000600	NR	INSERTO ESAGONALE M4	INSERT HEX M4			
BI7	BI000700	NR	INSERTO CILINDRICO M8	INSERT M8			
BR1	BR000100	NR	GROWER SEZ.RETT.SPIGOLI VIVI PESANTE UNI 9195 ACC.MOLLE D 6 Z.D.BIANCA	GROWER SEZ.RETT. SHARP HEAVY UNI 9195 ACC.MOLLE D 6 Z.D. WHITE	RONDELLE GROWER SECT.RECT. UNI 9195 ACC.MOLLE D 6 GALVANISÉE BLANCHE	GROWER UNTERLEGSCHIEBE UNI 9195 D 6 Z.D. WEIß	ARANDELA GROWER SEC. RECT. UNI 9195 D 6 GALVANIZADA BLANCA
BR2	BR000200	NR	RONDELLA PIANA DIN 125-A HV100 D 4 Z.BIANCA	PLAIN WASHER DIN 125-A HV100 D 4 Z. WHITE	RONDELLE PLATE DIN 125-A HV100 D 4 Z.BLANCHE	FLACHE UNTERLEGSCHIEBE DIN 125-A HV100 D 4 Z.WEIß	ARANDELA PLANA DIN 125-A HV100 D 4 GALVANIZADA BLANCA
BR3	BR000300	NR	RONDELLA PIANA DIN 125-A HV100 D 5 Z.BIANCA	PLAIN WASHER DIN 125-A HV100 D 5 Z. WHITE	RONDELLE PLATE DIN 125-A HV100 D 5 Z.BLANCHE	FLACHE UNTERLEGSCHIEBE DIN 125-A HV100 D 5 Z.WEIß	ARANDELA PLANA DIN 125-A HV100 D 5 GALVANIZADA BLANCA
BR4	BR000400	NR	RONDELLA PIANA DIN 125-A HV100 D 6 Z.BIANCA	PLAIN WASHER DIN 125-A HV100 D 6 Z. WHITE	RONDELLE PLATE DIN 125-A HV100 D 6 Z.BLANCHE	FLACHE UNTERLEGSCHIEBE DIN 125-A HV100 D 6 Z. WEIß	ARANDELA PLANA DIN 125-A HV100 D 6 GALVANIZADA BLANCA





POS	Codice	U.M.	 Descrizione	 Description	 Designation	 Benennung	 Descripción
BR5	BR000500	NR	RONDELLA PIANA DIN 125-A HV100 D 8 Z.BIANCA	PLAIN WASHER DIN 125-A HV100 D 8 Z. WHITE	RONDELLE PLATE DIN 125-A HV100 D 8 Z.BLANCHE	FLACHE UNTERLEGSCHIEBE DIN 125-A HV100 D 8 Z. WEIß	ARANDELA PLANA DIN 125-A HV100 D 8 GALVANIZADA BLANCA
BR6	BR000600	NR	RONDELLA PIANA DIN 125-A HV100 D 10 Z.BIANCA	PLAIN WASHER DIN 125-A HV100 D 10 Z. WHITE	RONDELLE PLATE DIN 125-A HV100 D 10 Z.BLANCHE	FLACHE UNTERLEGSCHIEBE DIN 125-A HV100 D 10 Z. WEIß	ARANDELA PLANA DIN 125-A HV100 D 10 GALVANIZADA BLANCA
BR7	BR000700	NR	RONDELLA PIANA DIN 125-A HV100 D 12 Z.BIANCA	PLAIN WASHER DIN 125-A HV100 D 12 Z. WHITE	RONDELLE PLATE DIN 125-A HV100 D 12 Z.BLANCHE	FLACHE UNTERLEGSCHIEBE DIN 125-A HV100 D 12 Z. WEIß	ARANDELA PLANA DIN 125-A HV100 D 12 GALVANIZADA BLANCA
BR8	BR000800	NR	ROSETTA PIANA FASCIA LARGA E=3D DIN 9021 HV100 D 10 X 30 X 2,5 Z.BIANCA	WIDE BAND AND FLAT WASHER DIN 9021 HV100 3D = D 10 X 30 X 2.5 Z WHITE	RONDELLE PLATE BANDE LARGE E=3D DIN 9021 HV100 D 10 X 30 X 2,5 Z.BLANCHE	FLACHE UNTERLEGSCHIEBE DIN 9021 HV100 3D = D 10 X 30 X 2.5 Z WEIß	ARANDELA DE BANDA ANCHA DIN 9021 HV100 D 10 X 30 X 2,5 GALVANIZADA BLANCA
BR9	BR000900	NR	ROSETTA PIANA FASCIA LARGA E=3D DIN 9021 HV100 D 12 X 36 X 2,5 Z.BIANCA	WIDE BAND AND FLAT WASHER DIN 9021 HV100 3D = D 12 X 36 X 2.5 Z WHITE	RONDELLE PLATE LARGE BANDE =3D DIN 9021 HV100 D 12 X 36 X 2,5 GALVANISÉE BLANCHE	SCHEIBE	ARANDELA
BR10	BR001000	NR	RONDELLA X CARPENTERIA DIN 6916 HV 300 D 16 Z.BIANCA	CARPENTRY WASHER DIN 6916 HV 300 D 16 Z WHITE	RONDELLE POUR CHARPENTERIE DIN 6916 HV 300 D 16 Z.BLANCHE	ZIMMEREI UNTERLEGSCHIEBE DIN 6916 HV 300 D 16 Z WEIß	ARANDELA DE CARPINTERÍA DIN 6916 HV 300 D 16 GALVANIZADA BLANCA
BR11	BR001100	NR	ROSETTE SPECIALI HV100 D 25 X 51 X 1 Z.BIANCA	SPECIAL WASHERS HV100 D 25 X 51 X 1 Z. WHITE	RONDELLES SPÉCIALES HV100 D 25 X 51 X 1 GALVANISATION BLANCHE	SCHEIBE	ARANDELA
BR13	BR001300	NR	RONDELLA DENTELLATURA ESTERNA DIN 6798-A ACC.MOLLE D 3 Z.D.BIANCA	WASHER EXTERNAL SERRATION DIN 6798-A ACC.MOLLE D 3 ZD WHITE	RONDELLE À DENTURE EXTÉRIEURE DIN 6798-A ACC.MOLLE D 3 Z.D GALVANISATION BLANCHE	SCHEIBE	ARANDELA
BR14	BR001400	NR	ROSETTA PIANA FASCIA LARGA E=3D DIN 9021 HV100 D 5 X 15 X 1,2 Z.BIANCA	WIDE BAND AND FLAT WASHER DIN 9021 HV100 3D = D 5 X 15 X 1.2 Z WHIT	RONDELLE PLATE BANDE LARGE E=3D DIN 9021 HV100 D 5 X 15 X 1,2 Z.BLANCHE	UNTERLEGSCHIEBE DIN 9021 HV100 3D = D 5 X 15 X 1.2 Z WEIß	ARANDELA PLANA CINTA LUNGA DIN 9021 HV100 D 5 X 15 X 1,2 GALVANIZADA BLANCA
BR15	BR001500	NR	ROSETTA PIANA FASCIA LARGA E=3D DIN 9021 HV100 D 6 X 18 X 1,5 Z.BIANCA	WIDE BAND AND FLAT WASHER DIN 9021 HV100 3D = D 6 X 18 X 1.5 Z WHITE	RONDELLE PLATE BANDE LARGE E=3D DIN 9021 HV100 D 6 X 18 X 1,5 Z.BLANCHE	UNTERLEGSCHIEBE DIN 9021 HV100 3D = D 6 X 18 X 1.5 Z WEIß	ARANDELA PLANA CINTA LUNGA E=3D DIN 9021 HV100 D 6 X 18 X 1,5 GALVANIZADA BLANCA



POS	Codice	U.M.	 Descrizione	 Description	 Designation	 Benennung	 Descripción
BR16	BR001600	NR	ROSETTA PIANA FASCIA LARGA E=3D DIN 9021 HV100 D 8 X 24 X 2 Z.BIANCA	WIDE BAND AND FLAT WASHER DIN 9021 HV100 3D = D 8 X 24 X 2 Z. WHITE	RONDELLE PLATE BANDE LARGE E=3D DIN 9021 HV100 D 8 X 24 X 2 Z.BLANCHE	UNTERLEGSCHEIBE DIN 9021 HV100 3D = D 8 X 24 X 2 Z. WEIß	ARANDELA PLANA CINTA LUNGA E=3D DIN 9021 HV100 D 8 X 24 X 2 GALVANIZADA BLANCA
BR17	BR001700	NR	ROSETTA PIANA FASCIA LARGA E=3D DIN 9021 HV100 D 4 X 12 X 1 Z.BIANCA	WIDE BAND AND FLAT WASHER DIN 9021 HV100 D = 3D 4 X 12 X 1 Z. WHITE	RONDELLE PLASTE BANDE LARGEDIN 9021 HV100 D 4 X 12 X 1 GALVANISATION BLANCHE	SCHEIBE	ARANDELA
BR18	BR001800	NR	RONDELLA PIANA DIN 125-A NYLON D 4	PLAIN WASHER DIN 125-A NYLON D 4	RONDELLE PLATE DIN 125-A NYLON D 4	SCHEIBE	ARANDELA
BR19	BR001900	NR	RONDELLA PIANA DIN 125-A HV100 D 3 Z.BIANCA	PLAIN WASHER DIN 125-A HV100 D 3 Z. WHITE	RONDELLE PLATE DIN 125-A HV100 D 3 GALVANISATION BLANCHE	SCHEIBE	ARANDELA
BR20	BR002000	NR	RONDELLA PIANA DIN 125-A HV100 D 16 Z.BIANCA	PLAIN WASHER DIN 125-A HV100 D 16 Z. WHITE	RONDELLE PLATE DIN 125-A HV100 D 16 GALVANISATION BLANCHE	SCHEIBE	ARANDELA
BR21	BR002100	NR	ROSETTA PIANA FASCIA LARGA E=3D DIN 9021 HV100 D 16 X 48 X 4 Z.BIANCA	WIDE BAND AND FLAT WASHER DIN 9021 HV100 3D = D 16 X 48 X 4 Z. WHITE	RONDELLE PLATE BANDE LARGE E=3D DIN 9021 HV100 D 16 X 48 X 4 GALVANISÉE BLANCHE	FLACHE UNTERLEGSCHEIBE DIN 9021 HV100 3D = D 16 X 48 X 4 Z. WEIß	ARANDELA PLANA BANDA ANCHA DIN 9021 HV100 D 16 X 48 X 4 GALVANIZADA BLANCA
BR22	BR002200	NR	GROWER SEZ.RETT.SPIGOLI VIVI PESANTE UNI 9195 ACC.MOLLE D 8 Z.D.BIANCA	GROWER SECTION. RECT. SHARP HEAVY UNI 9195 STAINLESS SPRINGS D 8 Z.D. WHITE	RONDELLE GROWER SECT. RECT. ARÊTES AIGUËS D 8 Z.D. BLANC	GROWER UNTERLEGSCHEIBE - WEIß	ARANDELA GROWER SECT. RECT. ÁNGULOS VIVOS UNI 9195 GALVANIZADA BLANCA
BR23	BR002300	NR	ROSETTA PIANA FASCIA LARGA E=3D DIN 9021 HV100 D 3 X 12 X 1 Z.BIANCA	WIDE BAND AND FLAT WASHER DIN 9021 HV100 D = 3D 3 X 12 X 1 Z. WHITE	RONDELLE PLATE BANDE LARGE DIN 9021 HV100 D 3 X 12 X 1 GALVANISATION BLANCHE	SCHEIBE	ARANDELA
BR24	BR002400	NR	ROSETTA PIANA FASCIA LARGA E=3D DIN 9021 HV100 D 14 X 42 X 3 Z.BIANCA	WIDE BAND AND FLAT WASHER DIN 9021 HV100 D = 3D 14 X 42 X 3 Z. WHITE	RONDELLE PLATE BANDE LARGE DIN 9021 HV100 D 14 X 42 X 3 GALVANISATION BLANCHE	SCHEIBE	ARANDELA
BR25	BR002500	NR	GROWER SEZ.RETT.SPIGOLI VIVI PESANTE UNI 9195 ACC.MOLLE D 10 Z.D.BIANCA	GROWER SEZ.RETT. SHARP HEAVY UNI 9195 ACC.MOLLE D 10 Z.D. WHITE	RONDELLE GROWER SECT. RECT. ARÊTES AIGUËS UNI 9195 D 10 Z.D. BLANC	GROWER UNTERLEGSCHEIBE - WEIß	ARANDELA GROWER SECT. RECT. ÁNGULOS VIVOS UNI 9195 GALVANIZADA BLANCA





POS	Codice	U.M.	 Descrizione	 Description	 Designation	 Benennung	 Descripción
BR26	BR002600	NR	RONDELLA PIANA DIN 125-A D 30 Z.BIANCA	PLAIN WASHER DIN 125-A D 30 Z. WHITE	RONDELLE PLATE DIN 125-A D 30 GALVANISATION BLANCHE	SCHEIBE	ARANDELA
BR27	BR002700	NR	RONDELLA PIANA DIN 125-A HV100 D 14 Z.BIANCA	PLAIN WASHER DIN 125-A HV100 D 14 Z. WHITE	RONDELLE PLATE DIN 125-A HV100 D 14 Z.BLANCHE	FLACHE UNTERLEGSCHIEBE DIN 125-A HV100 D 14 Z. - WEIß	ARANDELA PLANA DIN 125-A HV100 D 14 GALVANIZADA BLANCA
BR28	BR002800	NR	ROSETTA PIANA FASCIA LARGA D 6 X 24 X 2 Z.BIANCA	WIDE BAND AND FLAT WASHER D 6 X 24 X 2 Z WHITE	RONDELLE PLATE BANDE LARGE D 6 X 24 X 2 Z BLANCHE	UNTERLEGSCHIEBE D 6 X 24 X 2 Z - WEIß	ARANDELA PLANA CINTA LUNGA D 6 X 24 X 2 GALVANIZADA BLANCA
BR29	BR002900	NR	RONDELLA PIANA DIN 125-A HV100 D 18 Z.BIANCA	PLAIN WASHER DIN 125-A HV100 D 18 Z. WHITE	RONDELLE PLATE DIN 125-A HV100 D 18 Z. BLANC	FLACHE UNTERLEGSCHIEBE DIN 125-A HV100 D 18 Z. WEIß	ARANDELA PLANA DIN 125-A HV100 D 18 GALVANIZADA BLANCA
BR30	BR003000	NR	RONDELLA PIANA DIN 125-A HV100 D 20 Z.BIANCA	PLAIN WASHER DIN 125-A HV100 D 20 Z. WHITE	RONDELLE PLATE DIN 125-A HV100 D 20 GALVANISÉE BLANCHE	FLACHE UNTERLEGSCHIEBE DIN 125-A HV100 D 20 Z. WEIß	ARANDELA PLANA DIN 125-A HV100 D 20 GALVANIZADA BLANCA
BR31	BR003100	NR	GROWER SEZ.RETT.SPIGOLI VIVI PESANTE UNI 9195 ACC.MOLLE D 12 Z.D.BIANCA	GROWER SEZ.RETT. SHARP HEAVY UNI 9195 ACC.MOLLE D 12 Z.D. WHITE	RONDELLE GROWER SECT. RECT. ARÊTE AIGUË UNI 9195 ACC.MOLLE D 12 Z.D.BLANC	GROWER UNTERLEGSCHIEBE UNI 9195 ACC.MOLLE D 12 Z.D. WEIß	ARANDELA GROWER SECT. RECT. ÁNGULOS VIVOS UNI 9195 D 12 GALVANIZADA BLANCA
BR32	BR003200	NR	ROSETTE SPECIALI HV100 D 30 X 42 X 0.5 Z.BIANCA	SPECIAL WASHERS HV100 D 30 X 42 X 0.5 Z. WHITE	RONDELLES SPÉCIALES HV100 D 30 X 42 X 0.5 GALVANISATION BLANCHE	SCHEIBE	ARANDELA
BR33	BR003300	NR	ROSETTE SPECIALI HV100 D 30 X 61 X 1 Z.BIANCA	SPECIAL WASHERS HV100 D 30 X 61 X 1 Z. WHITE	RONDELLES SPÉCIALES HV100 D 30 X 61 X 1 GALVANISATION BLANCHE	SCHEIBE	ARANDELA
BR34	BR003400	NR	ROSETTE SPECIALI HV100 D 42 X 52 X 0.2 Z.BIANCA	SPECIAL WASHERS HV100 D 42 X 52 X 0.2 Z. WHITE	RONDELLES SPÉCIALES HV100 D 42 X 52 X 0.2 GALVANISATION BLANCHE	SCHEIBE	ARANDELA
BR35	BR003500	NR	ROSETTE SPECIALI HV100 D 42 X 52 X 0.3 Z.BIANCA	SPECIAL WASHERS HV100 D 42 X 52 X 0.3 Z. WHITE	RONDELLES SPÉCIALES HV100 D 42 X 52 X 0.3 GALVANISATION BLANCHE	SCHEIBE	ARANDELA
BR36	BR003600	NR	ROSETTE SPECIALI HV100 D 42 X 52 X 1 Z.BIANCA	SPECIAL WASHERS HV100 D 42 X 52 X 1 Z. WHITE	RONDELLES SPÉCIALES HV100 D 42 X 52 X 1 GALVANISATION BLANCHE	SCHEIBE	ARANDELA

POS	Codice	U.M.	 Descrizione	 Description	 Designation	 Benennung	 Descripción
BR37	BR003700	NR	ROSETTE SPECIALI HV100 D 42 X 52 X 1.5 Z.BIANCA	SPECIAL WASHERS HV100 D 42 X 52 X 1.5 Z. WHITE	RONDELLES SPÉCIALES HV100 D 42 X 52 X 1.5 GALVANISATION BLANCHE	SCHEIBE	ARANDELA
BR38	BR003800	NR	ROSETTE SPECIALI HV100 D 42 X 52 X 2 Z.BIANCA	SPECIAL WASHERS HV100 D 42 X 52 X 2 Z. WHITE	RONDELLES SPÉCIALES HV100 D 42 X 52 X 2 GALVANISATION BLANCHE	SCHEIBE	ARANDELA
BR39	BR003900	NR	ROSETTA PIANA FASCIA LARGA E=3D DIN 9021 HV100 D 18 X 48 X 4 Z.BIANCA	WIDE BAND AND FLAT WASHER DIN 9021 HV100 3D = D 18 X 48 X 4 Z. WHITE	RONDELLE PLATE BANDE LARGE E=3D DIN 9021 HV100 D 18 X 48 X 4 GALVANISÉE BLANCHE	FLACHE UNTERLEGSCHIEBE DIN 9021 HV100 3D = D 18 X 48 X 4 Z. WEIß	ARANDELA PLANA BANDA ANCHA DIN 9021 HV100 D 18 X 48 X 4 GALVANIZADA BLANCA
BR40	BR004000	NR	ROSETTA SCHNORR ZINCATE D 6	WASHER	RONDELLE	SCHEIBE	ARANDELA
BR41	BR004100	NR	GROWER SEZ.RETT.SPIGOLI VIVI PESANTE UNI 9195 ACC.MOLLE D 14 Z.D.BIANCA	GROWER SEZ.RETT. SHARP HEAVY UNI 9195 ACC.MOLLE D 14 Z.D. WHITE	RONDELLE GROWER SECT. RECT. ARÊTE AIGUË UNI 9195 ACC.MOLLE D 14 Z.D.BLANC	GROWER UNTERLEGSCHIEBE UNI 9195 ACC.MOLLE D 14 Z.D. WEIß	ARANDELA GROWER SECT. RECT. ÁNGULOS VIVOS UNI 9195 D 14 GALVANIZADA BLANCA
BR42	BR004200	NR	RONDELLA X CARPENTERIA DIN 6916 HV 300 D 14 Z.BIANCA	CARPENTRY WASHER DIN 6916 HV 300 D 14 Z WHITE	RONDELLE POUR CHARPENTERIE DIN 6916 HV 300 D 14 Z.BLANCHE	ZIMMEREI UNTERLEGSCHIEBE DIN 6916 HV 300 D 14 Z WEIß	ARANDELA DE CARPINTERÍA DIN 6916 HV 300 D 14 GALVANIZADA BLANCA
BR43	BR004300	NR	RONDELLA X CARPENTERIA DIN 125-A HV 300 D 10 Z.BIANCA	CARPENTRY WASHER DIN 125-A HV 300 D 10 Z WHITE	RONDELLE POUR CHARPENTERIE DIN 125-A HV 300 D 10 Z.BLANCHE	ZIMMEREI UNTERLEGSCHIEBE DIN 125-A HV 300 D 10 Z WEIß	ARANDELA DE CARPINTERÍA DIN 125-A HV 300 D 10 GALVANIZADA BLANCA
BR44	BR004400	NR	RONDELLA X CARPENTERIA DIN 125-A HV 300 D 20 Z.BIANCA	CARPENTRY WASHER DIN 125-A HV 300 D 20 Z WHITE	RONDELLE POUR CHARPENTERIE DIN 125-A HV 300 D 20 Z.BLANCHE	ZIMMEREI UNTERLEGSCHIEBE DIN 125-A HV 300 D 20 Z WEIß	ARANDELA DE CARPINTERÍA DIN 125-A HV 300 D 20 GALVANIZADA BLANCA
BR45	BR004500	NR	RONDELLA PIANA DIN 125-A HV200 D 10 Z.BIANCA	PLAIN WASHER DIN 125-A HV200 D 10 Z. WHITE	RONDELLE POUR CHARPENTERIE	ZIMMEREI UNTERLEGSCHIEBE	ARANDELA DE CARPINTERÍA
BR48	BR004800	NR	RONDELLA PIANA DIN 125-A HV100 D 22 Z.BIANCA	PLAIN WASHER DIN 125-A HV100 D 22 Z. WHITE	RONDELLE POUR CHARPENTERIE	ZIMMEREI UNTERLEGSCHIEBE	ARANDELA DE CARPINTERÍA
BR49	BR004900	NR	ROSETTA PIANA FASCIA LARGA E=4D DIN 9021 HV100 D 12 X 48 X 2,5 Z.BIANCA	WASHER FLAT AND WIDE BAND E = 4D DIN 9021 HV100 D 12 X 48 X 2.5 Z. WHITE	RONDELLE POUR CHARPENTERIE	ZIMMEREI UNTERLEGSCHIEBE	ARANDELA DE CARPINTERÍA

POS	Codice	U.M.	 Descrizione	 Description	 Designation	 Benennung	 Descripción
BR50	BR005000	NR	ROSETTA PIANA FASCIA LARGA E=3D DIN 9021 HV100 D 20 X 60 X 4 Z.BIANCA	WASHER FLAT AND WIDE BAND E = 3D DIN 9021 HV100 D 20 X 60 X 4 Z. WHITE	RONDELLE POUR CHARPENTERIE	ZIMMEREI UNTERLEGSCHIEBE	ARANDELA DE CARPINTERÍA
BR53	BR005300	NR	RONDELLE ELASTICHE GROWER DIN 127-B ACC.MOLLE D 6 Z.D.BIANCA	ELASTIC WASHERS GROWER DIN 127-B ACC. SPRINGS D 6 Z.D. WHITE	RONDELLE POUR CHARPENTERIE	ZIMMEREI UNTERLEGSCHIEBE	ARANDELA DE CARPINTERÍA
BR54	BR005400	NR	ROSETTA DI SICUREZZA TIPO SCHNORR TIPO S INOX D 6	WASHER SCHNORR TYPE S INOX D 6 SECURITY	RONDELLE POUR CHARPENTERIE	ZIMMEREI UNTERLEGSCHIEBE	ARANDELA DE CARPINTERÍA
BR55	BR005500	NR	RONDELLA DENTELLATURA ESTERNA DIN 6798-A ACC.MOLLE D 5 Z.D.BIANCA	WASHER EXTERNAL SERRATION DIN 6798-A ACC. SPRINGS D 5 Z.D. WHITE	RONDELLE POUR CHARPENTERIE	ZIMMEREI UNTERLEGSCHIEBE	ARANDELA DE CARPINTERÍA
BR56	BR005600	NR	RONDELLA X CARPENTERIA DIN 6916 HV 300 D 12 Z.BIANCA	WASHER DIN 6916 HV 300 D 12 Z. WHITE	RONDELLE POUR CHARPENTERIE	ZIMMEREI UNTERLEGSCHIEBE	ARANDELA DE CARPINTERÍA
BR57	BR005700	NR	ROSETTE SPECIALI HV100 D 36 X 65 X 1 Z.BIANCA	SPECIAL WASHERS HV100 D 36 X 65 X 1 Z. WHITE	RONDELLES SPÉCIALES HV100 D 36 X 65 X 1 GALVANISATION BLANCHE	SCHEIBE	ARANDELA
BR58	BR005800	NR	ROSETTE SPECIALI HV100 D 50 X 60 X 1 Z.BIANCA	SPECIAL WASHERS HV100 D 50 X 60 X 1 Z. WHITE	RONDELLES SPÉCIALES HV100 D 50 X 60 X 1 GALVANISATION BLANCHE	SCHEIBE	ARANDELA
BR59	BR005900	NR	ROSETTE SPECIALI HV300 D 20 X 54 X 3 Z.BIANCA	SPECIAL WASHERS HV300 D 20 X 54 X 3 Z. WHITE	RONDELLES SPÉCIALES HV300 D 20 X 54 X 3 GALVANISATION BLANCHE	SCHEIBE HV300 D 20 X 54 X 3	ARANDELA HV300 D 20 X 54 X 3 Z.
BR60	BR006000	NR	RONDELLA PIANA DIN 125-A NYLON D 12	PLAIN WASHER DIN 125-A NYLON D 12	RONDELLE PLATE DIN 125-A NYLON D 12	SCHEIBE	ARANDELA
BR61	BR006100	NR	RONDELLA PIANA DIN 125-A INOX A2 D4	PLAIN WASHER DIN 125-A INOX A2 D4	RONDELLE POUR CHARPENTERIE	ZIMMEREI UNTERLEGSCHIEBE	ARANDELA DE CARPINTERÍA
BR62	BR006200	NR	RONDELLA PIANA DIN 125-A HV300 D 20 Z.BIANCA	PLAIN WASHER DIN 125-A HV300 D 20 Z. WHITE	RONDELLE POUR CHARPENTERIE	ZIMMEREI UNTERLEGSCHIEBE	ARANDELA DE CARPINTERÍA
BR63	BR006300	NR	RONDELLA ANTIROTAZIONE DIN463 HV100 D6.4 X M6	WASHER DIN463 HV100 D6.4 X M6	RONDELLE POUR CHARPENTERIE	ZIMMEREI UNTERLEGSCHIEBE	ARANDELA DE CARPINTERÍA
BS1	BS000100	NR	GRANO FILETTATO M6X12	SCREW	VIS	SCHRAUBE	TORNILLO





POS	Codice	U.M.	 Descrizione	 Description	 Designation	 Benennung	 Descripción
BS2	BS000200	NR	SPINA CIL. 8X16 UNI 6364-A H6 CMT + TMP	PIN CYLINDER 8 X 16 UNI 6364-A CMT H6 + TMP			
BS3	BS000300	NR	PRIGIONIERO M10X35	PIN	AXE	GEWINDESTIFT	CLAVIJA
BS4	BS000400	NR	SPINA ELASTICA 6X60 UNI 6873	PIN	AXE	STIFT	CLAVIJA
BS5	BS000500	NR	SPINA ELASTICA 6X14 UNI 6873	PIN	AXE	STIFT	CLAVIJA
BS6	BS000600	NR	SPINA SPIROL NORMALE DIN 7343 INOX A2 D 5X10	PIN	AXE	STIFT	CLAVIJA
BS7	BS000700	NR	RIVETTO ALLUMINIO Ø3X12	ALUMINUM RIVET Ø3X12			
BS8	BS000800	NR	MOLLA COMPRESSIONE INOX AISI 302 D10.668 S1.066 L31.75	SPRING COMPRESSION AISI 302 D10.668 S1.066 L31.75			
BS13	BS001300	NR	SPINA ELASTICA DIN 1481 ACC.MOLLE D 8 X 50	ELASTIC PIN DIN 1481 ACC SPRINGS D 8 X 50			
BS14	BS001400	NR	SPINA SPIROL NORMALE DIN 7343 ACC.MOLLE D 5 X 10	PIN SPIROL NORMAL DIN 7343 ACC. SPRINGS D 5 X 10			
BS15	BS001500	NR	RIVETTI A STRAPPO TB AL/AC DIN 7337 D 3,2 X 12	BLIND RIVETS TB AL / AC DIN 7337 D 3.2 X 12			
BS16	BS001600	NR	RIVETTI A STRAPPO TB AL/AC DIN 7337 D 4,8 X 12	BLIND RIVETS TB AL / AC DIN 7337 D 4.8 X 12			
BS17	BS001700	NR	RIVETTI A STRAPPO TB A2/A2 DIN 7337 D 4,8 X 12	BLIND RIVETS TB A2 / A2 DIN 7337 D 4.8 X 12			
BS21	BS002100	NR	RIVETTO ALLUMINIO Ø4X10	ALUMINUM RIVET Ø4X10			
BS22	BS002200	NR	PRIGIONIERO M10X80	PIN M10X80	AXE M10X80	GEWINDESTIFT M10X80	CLAVIJA M10X80
BV1	BV000100	NR	VITE TE PARZIALE FILETTO PG DIN 931 CL 8.8 M 8 X 80 Z.BIANCA	SCREW PARTIAL THREAD DIN 931 PG CL 8.8 M 8 X 80 Z. WHITE	VIS PARTIELLEMENT FILETÉE DIN 931 CL 8.8 M 8 X 80 GALVANISATION BLANCHE	SCHRAUBE	TORNILLO
BV2	BV000200	NR	VITE TE TUTTO FILETTO PG DIN 933 CL 8.8 M 8 X 60 Z.BIANCA	SCREW ALL THREAD DIN 933 PG CL 8.8 M 8 X 60 Z. WHITE	VIS ENTIÈREMENT FILETÉE DIN 933 CL 8.8 M 8 X 60 GALVANISATION BLANCHE	SCHRAUBE	TORNILLO
BV3	BV000300	NR	VITE TCEI PG DIN 912 CL 8.8 M 8 X 60 Z.BIANCA	SCREW DIN 912 PG CL 8.8 M 8 X 60 Z. WHITE	VIS DIN 912 CL 8.8 M 8 X 60 GALVANISATION BLANCHE	SCHRAUBE	TORNILLO





POS	Codice	U.M.	 Descrizione	 Description	 Designation	 Benennung	 Descripción
BV4	BV000400	NR	VITE TE PARZIALE FILETTO PG DIN 931 CL 8.8 M 8 X 50 Z.BIANCA	SCREW PARTIAL THREAD DIN 931 PG CL 8.8 M 8 X 50 Z. WHITE	VIS PARTIELLEMENT FILETÉE BLANC	TEILGEWINDESCHRAUBE DIN 931 PG CL 8.8 M 8 X 50 Z. WEIß	TORNILLO PARCIALMENTE ROSCADO PG DIN 931 CL 8.8 M 8 X 50 GALVANIZADO BLANCO
BV5	BV000500	NR	VITE TCEI PG DIN 912 CL 8.8 M 8 X 45 Z.BIANCA	SCREW DIN 912 PG CL 8.8 M8 X 45 Z. WHITE	VIS DIN 912 CL 8.8 M 8 X 45 GALVANISATION BLANCHE	SCHRAUBE	TORNILLOL
BV6	BV000600	NR	VITE TCEI PG DIN 912 CL 8.8 M 8 X 40 Z.BIANCA	SCREW DIN 912 PG CL 8.8 M8 X 40 Z.BIANCA	VIS DIN 912 CL 8.8 M 8 X 40 GALVANISATION BLANCHE	SCHRAUBE	TORNILLO
BV7	BV000700	NR	VITE TE TUTTO FILETTO PG DIN 933 CL 8.8 M 8 X 35 Z.BIANCA	SCREW ALL THREAD DIN 933 PG CL 8.8 M 8 X 35 Z. WHITE	VIS TE ENTIÈREMENT FILETÉE DIN 933 PG CL 8.8 M 8 X 35 Z. BLANC	VOLLGEWINDESCHRAUBE DIN 933 PG CL 8.8 M 8 X 35 Z. WEIß	TORNILLO TOTALMENTE ROSCADO PG DIN 933 CL 8.8 M 8 X 35 GALVANIZADO BLANCO
BV8	BV000800	NR	VITE TE TUTTO FILETTO PG DIN 933 CL 8.8 M 8 X 30 Z.BIANCA	SCREW ALL THREAD DIN 933 PG CL 8.8 M 8 X 30 Z. WHITE	VIS TE ENTIÈREMENT FILETÉE DIN 933 PG CL 8.8 M 8 X 30 Z. BLANC	VOLLGEWINDESCHRAUBE DIN 933 PG CL 8.8 M 8 X 30 Z. WEIß	TORNILLO TOTALMENTE ROSCADO PG DIN 933 CL 8.8 M 8 X 30 GALVANIZADO BLANCO
BV9	BV000900	NR	VITE TE TUTTO FILETTO PG DIN 933 CL 8.8 M 8 X 25 Z.BIANCA	SCREW ALL THREAD DIN 933 PG CL 8.8 M 8 X 25 Z. WHITE	VIS TE ENTIÈREMENT FILETÉE PG DIN 933 CL 8.8 M 8 X 25 Z.BLANC	VOLLGEWINDESCHRAUBE DIN 933 PG CL 8.8 M 8 X 25 Z. WEIß	TORNILLO TOTALMENTE ROSCADO PG DIN 933 CL 8.8 M 8 X 25 GALVANIZADO BLANCO
BV10	BV001000	NR	VITE TCEI PG DIN 912 CL 8.8 M 8 X 25 Z.BIANCA	SCREW DIN 912 PG CL 8.8 M8 X 25 Z. WHITE	VIS TCEI PG DIN 912 CL 8.8 M 8 X 25 Z.BLANC	SCHRAUBE DIN 912 PG CL 8.8 M8 X 25 Z. WEIß	TORNILLO TCEI PG DIN 912 CL 8.8 M 8 X 25 GALVANIZADO BLANCO
BV11	BV001100	NR	VITE TE TUTTO FILETTO PG DIN 933 CL 8.8 M 8 X 20 Z.BIANCA	SCREW ALL THREAD DIN 933 PG CL 8.8 M 8 X 20 Z. WHITE	VIS TE ENTIÈREMENT FILETÉE PG DIN 933 CL 8.8 M 8 X 20 Z.BLANC	VOLLGEWINDESCHRAUBE DIN 933 PG CL 8.8 M 8 X 20 Z. WEIß	TORNILLO TOTALMENTE ROSCADO PG DIN 933 CL 8.8 M 8 X 20 GALVANIZADO BLANCO
BV12	BV001200	NR	VITE TE TUTTO FILETTO PG DIN 933 CL 8.8 M 8 X 16 Z.BIANCA	SCREW ALL THREAD DIN 933 PG CL 8.8 M 8 X 16 Z. WHITE	VIS TE ENTIÈREMENT FILETÉE PG DIN 933 CL 8.8 M 8 X 16 Z.BLANC	VOLLGEWINDESCHREUBE DIN 933 PG CL 8.8 M 8 X 16 Z. WEIß	TORNILLO TOTALMENTE ROSCADO PG DIN 933 CL 8.8 M 8 X 16 GALVANIZADO BLANCO
BV13	BV001300	NR	VITE TCEI PG DIN 912 CL 8.8 M 8 X 16 Z.BIANCA	SCREW DIN 912 PG CL 8.8 M8 X 16 Z. WHITE	VIS TCEI PG DIN 912 CL 8.8 M 8 X 16 GALVANISÉE BLANCHE	SCHRAUBE DIN 912 PG CL 8.8 M8 X 16 Z. WEIß	TORNILLO DIN 912 CL 8.8 M 8 X 16 GALVANIZADO BLANCO
BV14	BV001400	NR	VITE TE TUTTO FILETTO PG DIN 933 CL 8.8 M 8 X 14 Z.BIANCA	SCREW ALL THREAD DIN 933 PG CL 8.8 M 8 X 14 Z. WHITE	VIS ENTIÈREMENT FILETÉE DIN 933 CL 8.8 M 8 X 14 GALVANISATION BLANCHE	SCHRAUBE	TORNILLO
BV15	BV001500	NR	VITE TCEI PG DIN 912 CL 8.8 M 6 X 45 Z.BIANCA	SCREW DIN 912 M6 X 45 CL 8.8 Z. WHITE	VIS DIN 912 CL 8.8 M 6 X 45 GALVANISATION BLANCHE	SCHRAUBE	TORNILLO

POS	Codice	U.M.	 Descrizione	 Description	 Designation	 Benennung	 Descripción
BV16	BV001600	NR	VITE TCEI PG DIN 912 CL 8.8 M 6 X 30 Z.BIANCA	SCREW DIN 912 M6 X 30 CL 8.8 Z. WHITE	VIS TCEI PG DIN 912 CL 8.8 M 6 X 30 Z.BLANC	SCHRAUBE DIN 912 M6 X 30 CL 8.8 Z. WEIß	TORNILLO TCEI PG DIN 912 CL 8.8 M 6 X 30 GALVANIZADO BLANCO
BV17	BV001700	NR	VITE TSPEI PG DIN 7991 CL 10.9 M 6 X 30 Z.BIANCA	SCREW DIN 7991 CL 10.9 M 6 X 30 Z. WHITE	VIS DIN 7991 CL 10.9 M 6 X 30 GALVANISATION BLANCHE	SCHRAUBE	TORNILLO
BV18	BV001800	NR	VITE TE TUTTO FILETTO PG DIN 933 CL 8.8 M 6 X 30 Z.BIANCA	SCREW ALL THREAD DIN 933 PG CL 8.8 M 6 X 30 Z. WHITE	VIS ENTIÈREMENT FILETÉE DIN 933 CL 8.8 M 6 X 30 GALVANISÉE BLANCHE	VOLLGEWINDESCHRAUBE DIN 933 PG CL 8.8 M 6 X 30 Z. WEIß	TORNILLO TOTALMENTE ROSCADO DIN 933 CL 8.8 M 6 X 30 GALVANIZADO BLANCO
BV19	BV001900	NR	VITE TBEI PG ISO 7380 CL 10.9 M 6 X 30 Z.BIANCA	SCREW ISO 7380 CL 10.9 M 6 X 30 Z. WHITE	VIS ISO 7380 CL 10.9 M 6 X 30 GALVANISATION BLANCHE	SCHRAUBE	TORNILLO
BV20	BV002000	NR	VITE TE TUTTO FILETTO PG DIN 933 CL 8.8 M 6 X 12 Z.BIANCA	SCREW ALL THREAD DIN 933 PG CL 8.8 M 6 X 12 Z. WHITE	VIS TE ENTIÈREMENT FILETÉE PG DIN 933 CL 8.8 M 6 X 12 Z.BIANCA	VOLLGEWINDESCHRAUBE DIN 933 PG CL 8.8 M 6 X 12 Z. WEIß	TORNILLO TOTALMENTE ROSCADO PG DIN 933 CL 8.8 M 6 X 12 GALVANIZADO BLANCO
BV21	BV002100	NR	VITE TCEI PG DIN 912 CL 8.8 M 6 X 12 Z.BIANCA	SCREW DIN 912 PG CL 8.8 M 6 X 12 Z. WHITE	VIS DIN 912 CL 8.8 M 6 X 12 GALVANISATION BLANCHE	SCHRAUBE	TORNILLO
BV22	BV002200	NR	VITE TCEI PG DIN 912 CL 8.8 M 5 X 45 Z.BIANCA	SCREW DIN 912 PG CL 8.8 M 5 X 45 Z. WHITE	VIS DIN 912 CL 8.8 M 5 X 45 GALVANISATION BLANCHE	SCHRAUBE	TORNILLO
BV23	BV002300	NR	VITE TE UNF ANSI B18.2.1 GR.5 5/16 X 1" Z.BIANCA	SCREW UNF ANSI B18.2.1 GR.5 5/16 X 1 "Z. WHITE	VIS UNF ANSI B18.2.1 GR.5 5/16 X 1" GALVANISATION BLANCHE	SCHRAUBE	TORNILLO
BV24	BV002400	NR	VITE TC CROCE PG DIN 7985 CL 4.8 M 4 X 8 Z.BIANCA	CROSS HEAD SCREW DIN 7985 PG CL 4.8 M 4 X 8 Z. WHITE	VIS TC EN CROIX PG DIN 7985 CL 4.8 M 4 X 8 Z.BLANC	KREUZSCHLITZCHRAUBE DIN 7985 PG CL 4.8 M 4 X 8 Z. WEIß	TORNILLO TC DE CRUZ PG DIN 7985 CL 4.8 M 4 X 8 GALVANIZADO BLANCO
BV25	BV002500	NR	VITE TCEI PG DIN 912 CL 8.8 M 4 X 16 Z.BIANCA	SCREW DIN 912 PG CL 8.8 M 4 X 16 Z. WHITE	VIS DIN 912 CL 8.8 M 4 X 16 GALVANISATION BLANCHE	SCHRAUBE	TORNILLO
BV26	BV002600	NR	VITE TCEI PG DIN 912 CL 8.8 M 6 X 50 Z.BIANCA	SCREW DIN 912 PG CL 8.8 M 6 X 50 Z. WHITE	VIS DIN 912 CL 8.8 M 6 X 50 GALVANISATION BLANCHE	SCHRAUBE	TORNILLO
BV27	BV002700	NR	VITE TSPEI PG DIN 7991 CL 10.9 M 6 X 40 Z.BIANCA	SCREW DIN 7991 CL 10.9 M 6 X 40 Z. WHITE	VIS DIN 7991 CL 10.9 M 6 X 40 GALVANISÉE BLANCHE	SCHRAUBE DIN 7991 CL 10.9 M 6 X 40 Z. WEIß	TORNILLO DIN 7991 CL 10.9 M 6 X 40 GALVANIZADO BLANCO
BV28	BV002800	NR	VITE TSPEI PG DIN 7991 CL 10.9 M 6 X 25 Z.BIANCA	SCREW DIN 7991 CL 10.9 M 6 X 25 Z. WHITE	VIS TSPEI PG DIN 7991 CL 10.9 M 6 X 25 Z.BLANC	SCHRAUBE DIN 7991 CL 10.9 M 6 X 25 Z. WEIß	TORNILLO TSPEI PG DIN 7991 CL 10.9 M 6 X 25 GALVANIZADO BLANCO





POS	Codice	U.M.	 Descrizione	 Description	 Designation	 Benennung	 Descripción
BV29	BV002900	NR	VITE TE TUTTO FILETTO PG DIN 933 CL 8.8 M 6 X 25 Z.BIANCA	SCREW ALL THREAD DIN 933 PG CL 8.8 M 6 X 25 Z. WHITE	VIS TE ENTIÈREMENT FILETÉE PG DIN 933 CL 8.8 M 6 X 25 Z.BLANC	VOLLGEWINDESCHRAUBE DIN 933 PG CL 8.8 M 6 X 25 Z. WEIß	TORNILLO TOTALMENTE ROSCADO PG DIN 933 CL 8.8 M 6 X 25 GALVANIZADO BLANCO
BV30	BV003000	NR	VITE TE TUTTO FILETTO PG DIN 933 CL 8.8 M 6 X 22 Z.BIANCA	SCREW ALL THREAD DIN 933 PG CL 8.8 M 6 X 22 Z. WHITE	VIS TE ENTIÈREMENT FILETÉE PG DIN 933 CL 8.8 M 6 X 22 Z.BLANC	VOLLGEWINDESCHRAUBE DIN 933 PG CL 8.8 M 6 X 22 Z. WEIß	TORNILLO TE TOTALMENTE ROSCADO PG DIN 933 CL 8.8 M 6 X 22 GALVANIZADO BLANCO
BV31	BV003100	NR	VITE TSPEI PG DIN 7991 CL 10.9 M 6 X 20 Z.BIANCA	SCREW DIN 7991 CL 10.9 M 6 X 20 Z. WHITE	VIS TSPEI PG DIN 7991 CL 10.9 M 6 X 20 Z.BLANC	SCHRAUBE DIN 7991 CL 10.9 M 6 X 20 Z. WEIß	TORNILLO TSPEI PG DIN 7991 CL 10.9 M 6 X 20 GALVANIZADO BLANCO
BV32	BV003200	NR	VITE TE TUTTO FILETTO PG DIN 933 CL 8.8 M 6 X 20 Z.BIANCA	SCREW ALL THREAD DIN 933 PG CL 8.8 M 6 X 20 Z. WHITE	VIS TE ENTIÈREMENT FILETÉE PG DIN 933 CL 8.8 M 6 X 20 Z.BLANC	VOLLGEWINDESCHRAUBE DIN 933 PG CL 8.8 M 6 X 20 Z. WEIß	TORNILLO TOTALMENTE ROSCADO PG DIN 933 CL 8.8 M 6 X 20 GALVANIZADO BLANCO
BV33	BV003300	NR	VITE TCEI PG DIN 912 CL 8.8 M 6 X 20 Z.BIANCA	SCREW DIN 912 PG CL 8.8 M 6 X 20 Z. WHITE	VIS TCEI PG DIN 912 CL 8.8 M 6 X 20 Z.BLANC	SCHRAUBE DIN 912 PG CL 8.8 M 6 X 20 Z. WEIß	TORNILLO TCEI PG DIN 912 CL 8.8 M 6 X 20 GALVANIZADO BLANCO
BV34	BV003400	NR	VITE TE TUTTO FILETTO PG DIN 933 CL 8.8 M 6 X 16 Z.BIANCA	SCREW ALL THREAD DIN 933 PG CL 8.8 M 6 X 16 Z. WHITE	VIS TE ENTIÈREMENT FILETÉE G DIN 933 CL 8.8 M 6 X 16 Z.BLANC	VOLLGEWINDESCHRAUBE DIN 933 PG CL 8.8 M 6 X 16 Z. WEIß	TORNILLO TOTALMENTE ROSCADO PG DIN 933 CL 8.8 M 6 X 16 GALVANIZADO BLANCO
BV35	BV003500	NR	VITE TBEI PG ISO 7380 CL 10.9 M 6 X 16 Z.BIANCA	SCREW ISO 7380 CL 10.9 M 6 X 16 Z. WHITE	VIS TBEI PG ISO 7380 CL 10.9 M 6 X 16 Z.BLANC	SCHRAUBE ISO 7380 CL 10.9 M 6 X 16 Z. WEIß	TORNILLO TBEI PG ISO 7380 CL 10.9 M 6 X 16 GALVANIZADO BLANCO
BV36	BV003600	NR	VITE TCEI PG DIN 912 CL 8.8 M 5 X 8 Z.BIANCA	SCREW DIN 912 PG CL 8.8 M 5 X 8 Z. WHITE	VIS DIN 912 CL 8.8 M 5 X 8 GALVANISATION BLANCHE	SCHRAUBE	TORNILLO
BV37	BV003700	NR	VITE TSPEI PG DIN 7991 CL 10.9 M 5 X 60 Z.BIANCA	SCREW DIN 7991 CL 10.9 M 5 X 60 Z. WHITE	VIS DIN 7991 CL 10.9 M 5 X 60 GALVANISATION BLANCHE	SCHRAUBE	TORNILLO
BV38	BV003800	NR	VITE TE PARZIALE FILETTO PG DIN 931 CL 8.8 M 5 X 60 Z.BIANCA	SCREW PARTIAL THREAD DIN 931 PG CL 8.8 M 5 X 60 Z. WHITE	VIS PARTILLEMENT FILETÉE DIN 931 CL 8.8 M 5 X 60 GALVANISATION BLANCHE	SCHRAUBE	TORNILLO
BV39	BV003900	NR	VITE TCEI PG DIN 912 CL 8.8 M 5 X 60 Z.BIANCA	SCREW DIN 912 PG CL 8.8 M 5 X 60 Z. WHITE	VIS DIN 912 CL 8.8 M 5 X 60 GALVANISATION BLANCHE	SCHRAUBE	TORNILLO
BV40	BV004000	NR	VITE TE PARZIALE FILETTO PG DIN 931 CL 8.8 M 5 X 55 Z.BIANCA	SCREW PARTIAL THREAD DIN 931 PG CL 8.8 M 5 X 55 Z. WHITE	VIS PARTIELLEMENT FILETÉE DIN 931 CL 8.8 M 5 X 55 GALVANISATION BLANCHE	SCHRAUBE	TORNILLO





POS	Codice	U.M.	 Descrizione	 Description	 Designation	 Benennung	 Descripción
BV41	BV004100	NR	VITE TE TUTTO FILETTO PG DIN 933 CL 8.8 M 5 X 16 Z.BIANCA	SCREW ALL THREAD DIN 933 PG CL 8.8 M 5 X 16 Z. WHITE	VIS TE ENTIÈREMENT FILETÉE PG DIN 933 CL 8.8 M 5 X 16 Z.BLANC	VOLLGEWINDESCHRAUBE DIN 933 PG CL 8.8 M 5 X 16 Z. WEIß	TORNILLO TOTALMENTE ROSCADO PG DIN 933 CL 8.8 M 5 X 16 GALVANIZADO BLANCO
BV42	BV004200	NR	VITE TC CROCE PG DIN 7985 CL 4.8 M 5 X 16 Z.BIANCA	CROSS HEAD SCREW DIN 7985 PG CL 4.8 M 5 X 16 Z. WHITE	VIS TC EN CROIX PG DIN 7985 CL 4.8 M 5 X 16 Z.BLANC	KREUZSCHLITZSCHRAUBE DIN 7985 PG CL 4.8 M 5 X 16 Z. WEIß	TORNILLO TC DE CRUZ PG DIN 7985 CL 4.8 M 5 X 16 GALVANIZADO BLANCO
BV43	BV004300	NR	VITE TE TUTTO FILETTO PG DIN 933 CL 8.8 M 5 X 12 Z.BIANCA	SCREW ALL THREAD DIN 933 PG CL 8.8 M 5 X 12 Z. WHITE	VIS ENTIÈREMENT FILETÉE DIN 933 CL 8.8 M 5 X 12 GALVANISATION BLANCHE	SCHRAUBE	TORNILLO
BV44	BV004400	NR	VITE TE UNF ANSI B18.2.1 GR.5 5/16 X 1"1/4 Z.BIANCA	SCREW UNF ANSI B18.2.1 GR.5 5/16 X 1 "1/4 Z. WHITE	VIS UNF ANSI B18.2.1 GR.5 5/16 X 1"1/4 GALVANISATION BLANCHE	SCHRAUBE	TORNILLO
BV45	BV004500	NR	VITE TE UNF ANSI B18.2.1 GR.5 5/16 X 1"1/4 Z.BIANCA	SCREW UNF ANSI B18.2.1 GR.5 5/16 X 1 "1/4 Z. WHITE	VIS UNF ANSI B18.2.1 GR.5 5/16 X 1"1/4 GALVANISATION BLANCHE	SCHRAUBE	TORNILLO
BV46	BV004600	NR	VITE TCEI PG DIN 912 CL 8.8 M 4 X 40 Z.BIANCA	SCREW DIN 912 PG CL 8.8 M 4 X 40 Z. WHITE	VIS DIN 912 CL 8.8 M 4 X 40 GALVANISATION BLANCHE	SCHRAUBE	TORNILLO
BV47	BV004700	NR	VITE TRILOB. AUTOFORM. TC CROCE PG DIN 7500-C C15 M 4 X 40 Z.BIANCA	TRILOB SCREW. AUTOFORM. TC CROSS PH DIN 7500-C C 15 M 4 X 40 Z. WHITE	VIS TRILOB. AUTOFORM. TC CROIX PG DIN 7500-C C15 M 4 X 40 GALVANISATION BLANCHE	SCHRAUBE	TORNILLO
BV48	BV004800	NR	VITE TRILOB. AUTOFORM. TC CROCE PG DIN 7500-C C15 M 4 X 20 Z.BIANCA	TRILOB SCREW. AUTOFORM. TC CROSS PG DIN 7500-C C15 M 4 X 20 Z. WHITE	VIS TRILOB. AUTOFORM. TC CROIX PG DIN 7500-C C15 M 4 X 20 GALVANISATION BLANCHE	SCHRAUBE	TORNILLO
BV49	BV004900	NR	VITE TC CROCE PG DIN 7985 CL 4.8 M 4 X 16 Z.BIANCA	CROSS HEAD SCREW DIN 7985 PG CL 4.8 M 4 X 16 Z. WHITE	VIS TC CROIX DIN 7985 CL 4.8 M 4 X 16 GALVANISATION BLANCHE	SCHRAUBE	TORNILLO
BV50	BV005000	NR	VITE AUTOFILETTANTE TE C/BORDINO DIN 6928 C15 4,8X50 Z.BIANCA	TAPPING SCREW TE C / BORDINO DIN 6928 C15 4.8 X50 Z. WHITE	VIS AUTOFILETÉE TE C/BORDINO DIN 6928 C15 4,8X50 GALVANISATION BLANCHE	SCHRAUBE	TORNILLO
BV51	BV005100	NR	VITE AUTOFILETTANTE TE C/BORDINO DIN 6928 C15 4,8X25 Z.BIANCA	TAPPING SCREW TE C / BORDINO DIN 6928 C15 4.8 X25 Z. WHITE	VIS AUTOFILETÉE TE C/BORDINO DIN 6928 C15 4,8X25 GALVANISATION BLANCHE	SCHRAUBE	TORNILLO





POS	Codice	U.M.	 Descrizione	 Description	 Designation	 Benennung	 Descripción
BV52	BV005200	NR	VITE TCEI PG DIN 912 CL 12.9 M 3 X 25 Z.D.BIANCA	SCREW DIN 912 M 3 CL 12.9 X 25 Z.D. WHITE	VIS TCEI PG DIN 912 CL 12.9 M 3 X 25 GALVANISATION BLANCHE	SCHRAUBE	TORNILLO
BV53	BV005300	NR	VITE TSPEI PG DIN 7991 CL 10.9 M 3 X 14 Z.BIANCA	SCREW DIN 7991 CL 10.9 M 3 X 14 Z. WHITE	VIS DIN 7991 CL 10.9 M 3 X 14 GALVANISATION BLANCHE	SCHRAUBLE	TORNILLO
BV54	BV005400	NR	VITE AUTOFIL.TC CROCE DIN 7981 C15 3,5 X 6,5 Z.BIANCA	AUTOFIL.TC CROSS SCREW DIN 7981 C15 3.5 X 6.5 Z. WHITE	VIS AUTOFILETÉE CROIX DIN 7981 C15 3,5 X 6,5 GALVANISATION BLANCHE	SCHRAUBE	TORNILLO
BV55	BV005500	NR	VITE TE PARZIALE FILETTO PG DIN 931 CL 10.9 M 16 X 55	SCREW PARTIAL THREAD DIN 931 PG CL 10.9 M 16 X 55	VIS TE PARTIELLEMENT FILETÉE PG DIN 931 CL 10.9 M 16 X 55	TEILGEWINDESCHRAUBE DIN 931 PG CL 10.9 M 16 X 55	TORNILLO PARCIALMENTE ROSCADO PG DIN 931 CL 10.9 M 16 X 55
BV56	BV005600	NR	VITE TE TUTTO FILETTO PG DIN 933 CL 8.8 M 16 X 40 Z.BIANCA	SCREW ALL THREAD DIN 933 PG CL 8.8 M 16 X 40 Z. WHITE	VIS ENTIÈREMENT FILETÉE DIN 933 CL 8.8 M 16 X 40 GALVANISATION BLANCHE	SCHRAUBE	TORNILLO
BV57	BV005700	NR	VITE TE PARZIALE FILETTO PG DIN 931 CL 10.9 M 16 X 220	SCREW PARTIAL THREAD DIN 931 PG CL 10.9 M 16 X 220	VIS PARTIELLEMENT FILETÉE DIN 931 CL 10.9 M 16 X 220	SCHRAUBE	TORNILLO
BV58	BV005800	NR	VITE TE 8.8 DIN933 M16X20 TESTA ALTA 8 ZN BIANCA	SCREW M16X20 DIN933 8.8 HEAD HIGH 8 ZN WHITE	VIS 8.8 DIN933 M16X20 TÊTE HAUTE 8 GALVANISATION BLANCHE	SCHRAUBE	TORNILLO
BV59	BV005900	NR	VITE TE TUTTO FILETTO PG DIN 933 CL 8.8 M 12 X 16 Z.BIANCA	SCREW ALL THREAD DIN 933 PG CL 8.8 M 12 X 16 Z. WHITE	VIS ENTIÈREMENT FILETÉE DIN 933 CL 8.8 M 12 X 16 GALVANISATION BLANCHE	SCHRAUBE	TORNILLO
BV60	BV006000	NR	VITE TE PARZIALE FILETTO PG DIN 931 CL 8.8 M 12 X 120 Z.BIANCA	SCREW PARTIAL THREAD DIN 931 PG CL 8.8 M 12 X 120 Z. WHITE	VIS PARTIELLEMENT FILETÉE DIN 931 CL 8.8 M 12 X 120 GALVANISATION BLANCHE	SCHRAUBE	TORNILLO
BV61	BV006100	NR	VITE TE PARZIALE FILETTO PG DIN 931 CL 8.8 M 10 X 50 Z.BIANCA	SCREW PARTIAL THREAD DIN 931 PG CL 8.8 M 10 X 50 Z. WHITE	VIS TE PARTIELLEMENT FILETÉE PG DIN 931 CL 8.8 M 10 X 50 Z.BLANC	TEILGEWINDESCHRAUBE DIN 931 PG CL 8.8 M 10 X 50 Z. WEIß	TORNILLO PARCIALMENTE ROSCADO PG DIN 931 CL 8.8 M 10 X 50 GALVANIZADO BLANCO
BV62	BV006200	NR	VITE TE TUTTO FILETTO PG DIN 933 CL 8.8 M 10 X 35 Z.BIANCA	SCREW ALL THREAD DIN 933 PG CL 8.8 M 10 X 35 Z. WHITE	VIS TE ENTIÈREMENT FILETÉE PG DIN 933 CL 8.8 M 10 X 35 Z.BLANC	VOLLGEWINDESCHRAUBE DIN 933 PG CL 8.8 M 10 X 35 Z. WEIß	TORNILLO TOTALMENTE ROSCADO PG DIN 933 CL 8.8 M 10 X 35 GALVANIZADO BLANCO





POS	Codice	U.M.	 Descrizione	 Description	 Designation	 Benennung	 Descripción
BV63	BV006300	NR	VITE TSPEI PG DIN 7991 CL 10.9 M 10 X 30 Z.BIANCA	SCREW DIN 7991 CL 10.9 M 10 X 30 Z. WHITE	VIS DIN 7991 CL 10.9 M 10 X 30 GALVANISATION BLANCHE	SCHRAUBE	TORNILLO
BV64	BV006400	NR	VITE TE TUTTO FILETTO PG DIN 933 CL 8.8 M 10 X 30 Z.BIANCA	SCREW ALL THREAD DIN 933 PG CL 8.8 M 10 X 30 Z. WHITE	VIS TE ENTIÈREMENT FILETÉE PG DIN 933 CL 8.8 M 10 X 30 Z.BLANC	VOLLGEWINDESCHRAUBE DIN 933 PG CL 8.8 M 10 X 30 Z. WEIß	TORNILLO PG DIN 933 CL 8.8 M 10 X 30 GALVANIZADO BLANCO
BV65	BV006500	NR	VITE TCEI PG DIN 912 CL 12.9 M 10 X 25 GEO 321 A	SCREW DIN 912 PG CL 12.9 M 10 X 25 GEO 321 A	VIS DIN 912 PG CL 12.9 M 10 X 25 GEO 321 A	SCHRAUBE DIN 912 PG CL 12.9 M 10 X 25 GEO 321 A	TORNILLO TCEI PG DIN 912 CL 12.9 M 10 X 25 GEO 321 A
BV66	BV006600	NR	VITE TCEI PG DIN 912 CL 8.8 M 10 X 25 Z.BIANCA	SCREW DIN 912 PG CL 8.8 M 10 X 25 Z. WHITE	VIS DIN 912 CL 8.8 M 10 X 25 GALVANISATION BLANCHE	SCHRAUBE	TORNILLO
BV67	BV006700	NR	VITE TE TUTTO FILETTO PG DIN 933 CL 8.8 M 10 X 20 Z.BIANCA	SCREW ALL THREAD DIN 933 PG CL 8.8 M 10 X 20 Z. WHITE	VIS ENTIÈREMENT FILETÉE PG DIN 933 CL 8.8 M 10 X 20 Z.BLANC	VOLLGEWINDESCHRAUBE DIN 933 PG CL 8.8 M 10 X 20 Z. WEIß	TORNILLO TOTALMENTE ROSCADO PG DIN 933 CL 8.8 M 10 X 20 GALVANIZADO BLANCO
BV68	BV006800	NR	VITE TE TUTTO FILETTO PG DIN 933 CL 8.8 M 10 X 18 Z.BIANCA	SCREW ALL THREAD DIN 933 PG CL 8.8 M 10 X 18 Z. WHITE	VIS ENTIÈREMENT FILETÉE DIN 933 PG CL 8.8 M 10 X 18 Z. BLANC	VOLLGEWINDESCHRAUBE DIN 933 PG CL 8.8 M 10 X 18 Z. WEIß	TORNILLO TOTALMENTE ROSCADO PG DIN 933 CL 8.8 M 10 X 18 GALVANIZADO BLANCO
BV69	BV006900	NR	VITE TRILOB. AUTOFORM. TSP CROCE PG DIN 7500-M C15 M 5 X 16 Z.BIANCA	TRILOB SCREW. AUTOFORM. TSP CROSS PG DIN 7500-M C15 M 5 X 16 Z. WHITE	VIS TRILOB. AUTOFORM. TSP CROIX PG DIN 7500-M C15 M 5 X 16 GALVANISATION BLANCHE	SCHRAUBE	TORNILLO
BV70	BV007000	NR	VITE TE PARZIALE FILETTO PG DIN 931 CL 8.8 M 8 X 70 Z.BIANCA	SCREW PARTIAL THREAD DIN 931 PG CL 8.8 M 8 X 70 Z. WHITE	VIS PARTIELLEMENT FILETÉE DIN 931 PG CL 8.8 M 8 X 70 Z. BLANC	TEILGEWINDESCHRAUBE DIN 931 PG CL 8.8 M 8 X 70 Z. WEIß	TORNILLO PARCIALMENTE ROSCADO PG DIN 931 CL 8.8 M 8 X 70 GALVANIZADO BLANCO
BV71	BV007100	NR	VITE TE PARZIALE FILETTO PG DIN 931 CL 8.8 M 8 X 65 Z.BIANCA	SCREW PARTIAL THREAD DIN 931 PG CL 8.8 M 8 X 65 Z. WHITE	VIS PARTIELLEMENT FILETÉE DIN 931 CL 8.8 M 8 X 65 GALVANISÉE BLANCHE	TEILGEWINDESCHRAUBE DIN 931 PG CL 8.8 M 8 X 65 Z. WEIß	TORNILLO PARCIALMENTE ROSCADO DIN 931 CL 8.8 M 8 X 65 GALVANIZADO BLANCO
BV72	BV007200	NR	VITE TE PARZIALE FILETTO PG DIN 931 CL 8.8 M 6 X 55 Z.BIANCA	SCREW PARTIAL THREAD DIN 931 PG CL 8.8 M 6 X 55 Z. WHITE	VIS PARTIELLEMENT FILETÉE DIN 931 CL 8.8 M 6 X 55 GALVANISÉE BLANCHE	TEILGEWINDESCHRAUBE DIN 931 PG CL 8.8 M 6 X 55 Z. WEIß	TORNILLO PARCIALMENTE ROSCADO DIN 931 CL 8.8 M 6 X 55 GALVANIZADO BLANCO
BV73	BV007300	NR	VITE TCEI PG DIN 912 CL 8.8 M 6 X 55 Z.BIANCA	SCREW DIN 912 PG CL 8.8 M 6 X 55 Z. WHITE	VIS TCEI PG DIN 912 CL 8.8 M 6 X 55 GALVANISATION BLANCHE	SCHRAUBE	TORNILLO





POS	Codice	U.M.	 Descrizione	 Description	 Designation	 Benennung	 Descripción
BV74	BV007400	NR	VITE TCEI PG DIN 912 CL 8.8 M 6 X 16 Z.BIANCA	SCREW DIN 912 PG CL 8.8 M 6 X 16 Z. WHITE	VIS DIN 912 CL 8.8 M 6 X 16 GALVANISATION BLANCHE	SCHRAUBE	TORNILLO
BV75	BV007500	NR	VITE TSPEI PG DIN 7991 CL 10.9 M 6 X 10 Z.BIANCA	SCREW DIN 7991 CL 10.9 M 6 X 10 Z. WHITE	VIS DIN 7991 CL 10.9 M 6 X 10 GALVANISATION BLANCHE	SCHRAUBE	TORNILLO
BV76	BV007600	NR	VITE TCEI PG DIN 912 CL 8.8 M 5 X 55 Z.BIANCA	SCREW DIN 912 PG CL 8.8 M 5 X 55 Z. WHITE	VIS DIN 912 CL 8.8 M 5 X 55 GALVANISATION BLANCHE	SCHRAUBE	TORNILLO
BV77	BV007700	NR	VITE TC CROCE PG DIN 7985 CL 4.8 M 6 X 16 Z.BIANCA	CROSS HEAD SCREW DIN 7985 PG CL 4.8 M 6 X 16 Z. WHITE	VIS DIN 7985 CL 4.8 M 6 X 16 GALVANISATION BLANCHE	SCHRAUBE	TORNILLO
BV78	BV007800	NR	VITE TRILOB. AUTOFORM. TC CROCE PG DIN 7500-C C15 M 5 X 12 Z.BIANCA	TRILOB SCREW. AUTOFORM. TC CROSS PG DIN 7500-C C15 M 5 X 12 Z. WHITE	VIS TRILOB. AUTOFORM. TC CROIX PG DIN 7500-C C15 M 5 X 12 GALVANISATION BLANCHE	SCHRAUBE	TORNILLO
BV79	BV007900	NR	VITE TE TUTTO FILETTO PG DIN 933 CL 8.8 M 4 X 35 Z.BIANCA	SCREW ALL THREAD DIN 933 PG CL 8.8 M 4 X 35 Z. WHITE	VIS ENTIÈREMENT FILETÉE DIN 933 CL 8.8 M 4 X 35 GALVANISATION BLANCHE	SCHRAUBE	TORNILLO
BV80	BV008000	NR	VITE AUTOFILETTANTE TE C/BORDINO DIN 6928 C15 4,8X35 Z.BIANCA	TAPPING SCREW TE C / BORDINO DIN 6928 C15 4.8 X35 Z. WHITE	VIS AUTOFILETÉE TE C/BORDINO DIN 6928 C15 4,8X35 GALVANISATION BLANCHE	SCHRAUBE	TORNILLO
BV81	BV008100	NR	VITE TCEI PG DIN 912 CL 12.9 M 3 X 14 Z.D.BIANCA	SCREW DIN 912 M 3 CL 12.9 X 14 Z.D. WHITE	VIS DIN 912 CL 12.9 M 3 X 14 GALVANISATION BLANCHE	SCHRAUBE	TORNILLO
BV82	BV008200	NR	VITE TE PARZIALE FILETTO PG DIN 931 CL 8.8 M 16 X 70 Z.BIANCA	SCREW PARTIAL THREAD DIN 931 PG CL 8.8 M 16 X 70 Z. WHITE	VIS PARTIELLEMENT FILETÉE PG DIN 931 CL 8.8 M 16 X 70 GALVANISATION BLANCHE	SCHRAUBE	TORNILLO
BV83	BV008300	NR	VITE TE PARZIALE FILETTO PG DIN 931 CL 8.8 M 16 X 260 Z.BIANCA	SCREW PARTIAL THREAD DIN 931 PG CL 8.8 M 16 X 260 Z. WHITE	VIS PARTIELLEMENT FILETÉE PG DIN 931 CL 8.8 M 16 X 260 GALVANISATION BLANCHE	SCHRAUBE	TORNILLO
BV84	BV008400	NR	VITE TE PARZIALE FILETTO PG DIN 931 CL 8.8 M 12 X 110 Z.BIANCA	SCREW PARTIAL THREAD DIN 931 PG CL 8.8 M 12 X 110 Z. WHITE	VIS PARTIELLEMENT FILETÉE DIN 931 CL 8.8 M 12 X 110 GALVANISATION BLANCHE	SCHRAUBE	TORNILLO
BV85	BV008500	NR	VITE TE TUTTO FILETTO PG DIN 933 CL 8.8 M 10 X 40 Z.BIANCA	SCREW THREAD DIN 933 PG CL 8.8 M 10 X 40 Z. WHITE	VIS FILETÉE DIN 933 PG CL 8.8 M 10 X 40 Z. BLANC	TEILGEWINDESCHRAUBE DIN 933 PG CL 8.8 M 10 X 40 Z. WEIß	TORNILLO ROSCADO PG DIN 933 CL 8.8 M 10 X 40 GALVANIZADO BLANCO

POS	Codice	U.M.	 Descrizione	 Description	 Designation	 Benennung	 Descripción
BV86	BV008600	NR	VITE TCEI PG DIN 912 CL 8.8 M 8 X 65 Z.BIANCA	SCREW DIN 912 PG CL 8.8 M 8 X 65 Z. WHITE	VIS DIN 912 CL 8.8 M 8 X 65 GALVANISATION BLANCHE	SCHRAUBE	TORNILLO
BV87	BV008700	NR	VITE TCEI PG DIN 912 CL 8.8 M 8 X 20 Z.BIANCA	SCREW DIN 931 PG CL 8.8 M 10 X 40 Z. WHITE	VIS DIN 931 PG CL 8.8 M 10 X 40 Z. BLANC	SCHRAUBE DIN 931 PG CL 8.8 M 10 X 40 Z. WEIß	TORNILLO TCEI PG DIN 912 CL 8.8 M 8 X 20 GALVANIZADO BLANCO
BV88	BV008800	NR	VITE TCEI PG DIN 912 CL 10.9 M 10 X 18 Z.BIANCA	SCREW DIN 912 PG CL 10.9 M 10 X 18 Z. WHITE	VIS DIN 912 CL 10.9 M 10 X 18 GALVANISATION BLANCHE	SCHRAUBE	TORNILLO
BV89	BV008900	NR	VITE TCEI PG DIN 912 CL 8.8 M 8 X 70 Z.BIANCA	SCREW DIN 912 PG CL 8.8 M 8 X 70 Z. WHITE	VIS DIN 912 CL 8.8 M 8 X 70 GALVANISATION BLANCHE	SCHRAUBE	TORNILLO
BV91	BV009100	NR	VITE TE PARZIALE FILETTO PG DIN 931 CL 8.8 M 6 X 40 Z.BIANCA	SCREW PARTIAL THREAD DIN 931 PG CL 8.8 M 6 X 40 Z. WHITE	VIS FILETÉE DIN 931 PG CL 8.8 M 6 X 40 Z. BLANC	VOLLGEWINDESCHRAUBE DIN 931 PG CL 8.8 M 6 X 40 Z. WEIß	TORNILLO PG DIN 931 CL 8.8 M 6 X 40 GALVANIZADO BLANCO
BV92	BV009200	NR	VITE TE TUTTO FILETTO PG DIN 933 CL 8.8 M 10 X 60 Z.BIANCA	SCREW ALL THREAD DIN 933 PG CL 8.8 M 10 X 60 Z. WHITE	VIS	SCHRAUBE	TORNILLO
BV93	BV009300	NR	VITE TSPEI PG DIN 7991 CL 10.9 M 5 X 20 Z.BIANCA	SCREW DIN 7991 CL 10.9 M 5 X 20 Z. WHITE	VIS DIN 7991 CL 10.9 M 5 X 20 GALVANISATION BLANCHE	SCHRAUBE	TORNILLO
BV94	BV009400	NR	VITE TC CROCE PG DIN 7985 CL 4.8 M 4 X 12 Z.BIANCA	CROSS HEAD SCREW DIN 7985 PG CL 4.8 M 4 X 12 Z. WHITE	VIS CROIX DIN 7985 CL 4.8 M 4 X 12 GALVANISATION BLANCHE	SCHRAUBE	TORNILLO
BV95	BV009500	NR	VITE TE TUTTO FILETTO PG DIN 933 CL 8.8 M 4 X 12 Z.BIANCA	SCREW ALL THREAD DIN 933 PG CL 8.8 M 4 X 12 Z. WHITE	VIS ENTIÈREMENT FILETÉE DIN 933 CL 8.8 M 4 X 12 GALVANISATION BLANCHE	SCHRAUBE	TORNILLO
BV96	BV009600	NR	VITE TCEI PG DIN 912 CL 12.9 M 12 X 30 DAC 320A	SCREW DIN 912 CL 12.9 M 12 X 30 DAC 320A	VIS DIN 912 CL 12.9 M 12 X 30 DAC 320A	SCHRAUBE DIN 912 CL 12.9 M 12 X 30 DAC 320A	TORNILLO TCEI PG DIN 912 CL 12.9 M 12 X 30 DAC 320A
BV97	BV009700	NR	VITE AUTOFIL.TESTA MEZZA TONDA C15 4,8 X 13 Z.BIANCA	HALF ROUND HEAD SELF TAPPING SCREW C15 4,8 X 13	VIS AUTOFILETÉE TÊTE DEMI-RONDE C15 4,8 X 13 GALVANISATION BLANCHE	SCHRAUBE	TORNILLO
BV98	BV009800	NR	VITE TC CROCE PG DIN 7985 CL 4.8 M 4 X 14 Z.BIANCA	SCREW DIN 7985 CL 4.8 M 4 X 14	VIS EN CROIX PG DIN 7985 CL 4.8 M 4 X 14 GALVANISÉE BLANCHE	KREUZSCHLITZSCHRAUBE DIN 7985 CL 4.8 M 4 X 14	TORNILLO CRUZ 7985 CL 4.8 M 4 X 14 GALVANIZADO BLANCO

POS	Codice	U.M.	 Descrizione	 Description	 Designation	 Benennung	 Descripción
BV99	BV009900	NR	VITE TE PARZIALE FILETTO PG DIN 931 CL 8.8 M 5 X 65 Z.BIANCA	SCREW PARTIAL THREAD DIN 931 PG CL 8.8 M 5 X 65 Z. WHITE	VIS PARTIELLEMENT FILETÉE DIN 931 CL 8.8 M 5 X 65 GALVANISATION BLANCHE	SCHRAUBE	TORNILLO
BV100	BV010000	NR	VITE AUTOFIL.TESTA MEZZA TONDA C15 4,8 X 16 Z.BIANCA	HALF ROUND HEAD SELF TAPPING SCREW C15 4,8 X 16	VIS AUTOFILETÉE TÊTE DEMI-RONDE C15 4,8 X 16 GALVANISATION BLANCHE	SCHRAUBE	TORNILLO
BV101	BV010100	NR	VITE TSPEI PG DIN 7991 CL 10.9 M 8 X 25 Z.BIANCA	SCREW DIN 7991 CL 10.9 M 8 X 25 Z. WHITE	VIS DIN 7991 CL 10.9 M 8 X 25 GALVANISATION BLANCHE		
BV102	BV010200	NR	VITE TCEI PG DIN 912 CL 8.8 M 4 X 30 Z.BIANCA	SCREW DIN 912 PG CL 8.8 M 4 X 30 WHITE Z	VIS DIN 912 CL 8.8 M 4 X 30 GALVANISATION BLANCHE	SCHRAUBE	TORNILLO
BV103	BV010300	NR	VITE TSPEI PG DIN 7991 CL 10.9 M 5 X 16 Z.BIANCA	SCREW DIN 7991 CL 10.9 M 5 X 16 Z. WHITE	VIS DIN 7991 CL 10.9 M 5 X 16 GALVANISATION BLANCHE	SCHRAUBE	TORNILLO
BV104	BV010400	NR	VITE TCEI BASSA PG DIN 7984 CL 10.9 M 12 X 18 Z.D.BIANCA	SCREW DIN 7984 LOW PG CL 10.9 M 12 X 18 Z. D. WHITE	VIS BASSE DIN 7984 CL 10.9 M 12 X 18 Z. BLANCHE	SCHRAUBE	TORNILLO
BV105	BV010500	NR	VITE TE PARZIALE FILETTO PG DIN 931 CL 8.8 M 12 X 75 Z.BIANCA	SCREW PARTIAL THREAD DIN 931 PG CL 8.8 M 12 X 75 Z. WHITE	VIS PARTIELLEMENT FILETÉE DIN 931 CL 8.8 M 12 X 75 GALVANISATION BLANCHE	SCHRAUBE	TORNILLO
BV106	BV010600	NR	VITE TE TUTTO FILETTO PG DIN 933 CL 8.8 M 8 X 22 Z.BIANCA	SCREW ALL THREAD DIN 933 PG CL 8.8 M 8 X 22 Z. WHITE	VIS ENTIÈREMENT FILETÉE DIN 933 PG CL 8.8 M 8 X 22 Z. BLANC	VOLLGEWINDESCHRAUBE DIN 933 PG CL 8.8 M 8 X 22 Z. WEIß	TORNILLO TOTALMENTE ROSCADO PG DIN 933 CL 8.8 M 8 X 22 GALVANIZADO BLANCO
BV107	BV010700	NR	VITE TE TUTTO FILETTO PG DIN 933 CL 8.8 M 6 X 35 Z.BIANCA	SCREW ALL THREAD DIN 933 PG CL 8.8 M 6 X 35 Z. WHITE	VIS ENTIÈREMENT FILETÉE DIN 933 CL 8.8 M 6 X 35 GALVANISATION BLANCHE	SCHRAUBE	TORNILLO
BV108	BV010800	NR	VITE TE PARZIALE FILETTO PG DIN 931 CL 8.8 M 4 X 45 Z.BIANCA	SCREW PARTIAL THREAD DIN 931 PG CL 8.8 M 4 X 45 Z. WHITE	VIS PARTIELLEMENT FILETÉE DIN 931 CL 8.8 M 4 X 45 GALVANISATION BLANCHE	SCHRAUBE	TORNILLO
BV109	BV010900	NR	VITE TE TUTTO FILETTO PG DIN 933 CL 10.9 M 16 X 45 Z.D.BIANCA	SCREW ALL THREAD DIN 933 PG CL 10.9 M 16 X 45 ZD WHITE	VIS ENTIÈREMENT FILETÉE DIN 933 CL 10.9 M 16 X 45 GALVANISATION BLANCHE	SCHRAUBE	TORNILLO
BV110	BV011000	NR	VITE TE PARZIALE FILETTO PG DIN 931 CL 10.9 M 16 X 100	SCREW PARTIAL THREAD DIN 931 PG CL 10.9 M 16 X 100	VIS PARTIELLEMENT FILETÉE DIN 931 CL 10.9 M 16 X 100	SCHRAUBE	TORNILLO
BV111	BV011100	NR	VITE TE PARZIALE FILETTO PG DIN 931 CL 10.9 M 16 X 105	SCREW PARTIAL THREAD DIN 931 PG CL 10.9 M 16 X 105	VIS PARTIELLEMENT FILETÉE DIN 931 CL 10.9 M 16 X 105	SCHRAUBE	TORNILLO

POS	Codice	U.M.	 Descrizione	 Description	 Designation	 Benennung	 Descripción
BV112	BV011200	NR	VITE TE TUTTO FILETTO PG DIN 933 CL 8.8 M 10 X 25 Z.BIANCA	SCREW ALL THREAD DIN 933 PG CL 8.8 M 10 X 25 Z. WHITE	VIS ENTIÈREMENT FILETÉE DIN 933 PG CL 8.8 M 10 X 25 Z. BLANC	VOLLGEWINDESCHRAUBE DIN 933 PG CL 8.8 M 10 X 25 Z. WEIß	TORNILLO TOTALMENTE ROSCADO PG DIN 933 CL 8.8 M 10 X 25 GALVANIZADO BLANCO
BV113	BV011300	NR	VITE TSPEI PG DIN 7991 CL 10.9 M 6 X 50 Z.BIANCA	TSPEI PG SCREW DIN 7991 CL 10.9 M 6 X 50 Z. WHITE	VIS DIN 7991 CL 10.9 M 6 X 50 Z. BLANC	TSPEI PG SCHRAUBE DIN 7991 CL 10.9 M 6 X 50 Z. WEIß	TORNILLO TSPEI PG DIN 7991 CL 10.9 M 6 X 50 GALVANIZADO BLANCO
BV114	BV011400	NR	VITE TSPEI PG DIN 7991 CL 10.9 M 8 X 25 Z.BIANCA	TSPEI PG SCREW DIN 7991 CL 10.9 M 8 X 25 Z. WHITE	VIS DIN 7991 CL 10.9 M 8 X 25 GALVANISATION BLANCHE	SCHRAUBE	TORNILLO
BV115	BV011500	NR	VITE TE TUTTO FILETTO PG DIN 933 CL 8.8 M 10 X 45 Z.BIANCA	SCREW ALL THREAD DIN 933 PG CL 8.8 M 10 X 45 Z. WHITE	VIS ENTIÈREMENT FILETÉE DIN 933 CL 8.8 M 10 X 45 GALVANISATION BLANCHE	SCHRAUBE	TORNILLO
BV116	BV011600	NR	VITE TE TUTTO FILETTO PG DIN 933 CL 8.8 M 5 X 8 Z.BIANCA	SCREW ALL THREAD DIN 933 PG CL 8.8 M 5 X 8 Z. WHITE	VIS ENTIÈREMENT FILETÉE DIN 933 CL 8.8 M 5 X 8 GALVANISATION BLANCHE	SCHRAUBE	TORNILLO
BV117	BV011700	NR	VITE TE TUTTO FILETTO PG DIN 933 CL 8.8 M 8 X 18 Z.BIANCA	SCREW ALL THREAD DIN 933 PG CL 8.8 M 8 X 18 Z. WHITE	VIS ENTIÈREMENT FILETÉE DIN 933 CL 8.8 M 8 X 18 GALVANISATION BLANCHE	SCHRAUBE	TORNILLO
BV118	BV011800	NR	VITE TE TUTTO FILETTO PG DIN 933 CL 8.8 M 8 X 40 Z.BIANCA	SCREW ALL THREAD DIN 933 PG CL 8.8 M 8 X 40 Z. WHITE	VIS ENTIÈREMENT FILETÉE DIN 933 PG CL 8.8 M 8 X 40 Z. BLANC	VOLLGEWINDESCHRAUBE DIN 933 PG CL 8.8 M 8 X 40 Z. WEIß	TORNILLO DIN 933 CL 8.8 M 8 X 40 GALVANIZADO BLANCO
BV119	BV011900	NR	VITE TCEI PG DIN 912 CL 8.8 M 8 X 100 Z.BIANCA	SCREW DIN 912 PG CL 8.8 M 8 X 100 Z. WHITE	VIS DIN 912 CL 8.8 M 8 X 100 GALVANISATION BLANCHE	SCHRAUBE	TORNILLO
BV120	BV012000	NR	VITE TCEI PG DIN 912 CL 8.8 M 8 X 110 Z.BIANCA	SCREW DIN 912 PG CL 8.8 M 8 X 110 Z. WHITE	VIS DIN 912 CL 8.8 M 8 X 110 GALVANISATION BLANCHE	SCHRAUBE	TORNILLO
BV121	BV012100	NR	VITE TE PARZIALE FILETTO PG DIN 931 CL 8.8 M 5 X 75 Z.BIANCA	SCREW PARTIAL THREAD DIN 931 PG CL 8.8 M 5 X 75 Z. WHITE	VIS PARTIELLEMENT FILETÉE DIN 931 CL 8.8 M 5 X 75 GALVANISATION BLANCHE	SCHRAUBE	TORNILLO
BV122	BV012200	NR	VITE TE PARZIALE FILETTO PG DIN 931 CL 8.8 M 12 X 130 Z.BIANCA	SCREW PARTIAL THREAD DIN 931 PG CL 8.8 M 12 X 130 Z. WHITE	VIS PARTIELLEMENT FILETÉE DIN 931 CL 8.8 M 12 X 130 GALVANISATION BLANCHE	SCHRAUBE	TORNILLO
BV123	BV012300	NR	VITE TC CROCE PG DIN 7985 CL 4.8 M 4 X 8 Z.BIANCA	CROSS HEAD SCREW DIN 7985 PG CL 4.8 M 4 X 8 Z. WHITE	VIS TC EN CROIX PG DIN 7985 CL 4.8 M 4 X 8 Z.BLANC	KREUZSCHLITZCHRAUBE DIN 7985 PG CL 4.8 M 4 X 8 Z. WEIß	TORNILLO TC DE CRUZ PG DIN 7985 CL 4.8 M 4 X 8 GALVANIZADO BLANCO





POS	Codice	U.M.	 Descrizione	 Description	 Designation	 Benennung	 Descripción
BV124	BV012400	NR	VITE TCEI PG DIN 912 CL 8.8 M 6 X 40 Z.BIANCA	SCREW DIN 912 PG CL 8.8 M 6 X 40 Z. WHITE	VIS DIN 912 CL 8.8 M 6 X 40 GALVANISATION BLANCHE	SCHRAUBE	TORNILLO
BV125	BV012500	NR	VITE TE TUTTO FILETTO PG DIN 933 CL 8.8 M 4 X 20 Z.BIANCA	SCREW ALL THREAD DIN 933 PG CL 8.8 M 4 X 20 Z. WHITE	VIS ENTIÈREMENT FILETÉE DIN 933 CL 8.8 M 4 X 20 GALVANISATION BLANCHE	SCHRAUBE	TORNILLO
BV126	BV012600	NR	VITE TE UNC ANSI B18.2.1 GR.5 3/8 X 1" Z.BIANCA	SCREW UNC ANSI B18.2.1 GR.5 3/8 X 1 "Z. WHITE	VIS UNC ANSI B18.2.1 GR.5 3/8 X 1" GALVANISATION BLANCHE	SCHRAUBE	TORNILLO
BV127	BV012700	NR	VITE TE UNC ANSI B18.2.1 GR.5 3/8 X 1" 1/4Z.BIANCA	SCREW UNC ANSI B18.2.1 GR.5 3/8 X 1 "1/4 Z. WHITE	VIS UNC ANSI B18.2.1 GR.5 3/8 X 1" 1/4 GALVANISATION BLANCHE	SCHRAUBE	TORNILLO
BV128	BV012800	NR	VITE TE TUTTO FILETTO PG DIN 933 CL 8.8 M 4 X 16 Z.BIANCA	SCREW ALL THREAD DIN 933 PG CL 8.8 M 4 X 16 Z. WHITE	VIS ENTIÈREMENT FILETÉE DIN 933 CL 8.8 M 4 X 16 GALVANISATION BLANCHE	SCHRAUBE	TORNILLO
BV129	BV012900	NR	VITE TCEI PG DIN 912 CL 8.8 M 5 X 16 Z.BIANCA	SCREW DIN 912 PG CL 8.8 M 5 X 16 Z. WHITE	VIS DIN 912 CL 8.8 M 5 X 16 GALVANISATION BLANCHE	SCHRAUBE	TORNILLO
BV130	BV013000	NR	VITE TCEI PG DIN 912 CL 8.8 M 3 X 12 Z.BIANCA	SCREW DIN 912 PG CL 8.8 M 3 X 12 Z. WHITE	VIS DIN 912 CL 8.8 M 3 X 12 GALVANISATION BLANCHE	SCHRAUBE	TORNILLO
BV131	BV013100	NR	VITE TSPEI PG DIN 7991 CL 10.9 M 5 X 30 Z.BIANCA	TSPEI PG SCREW DIN 7991 CL 10.9 M 5 X 30 Z. WHITE	VIS DIN 7991 CL 10.9 M 5 X 30 GALVANISATION BLANCHE	SCHRAUBE	TORNILLO
BV132	BV013200	NR	VITE TSPEI PG DIN 7991 CL 10.9 M 5 X 55 Z.BIANCA	TSPEI PG SCREW DIN 7991 CL 10.9 M 5 X 55 Z. WHITE	VIS DIN 7991 CL 10.9 M 5 X 55 GALVANISATION BLANCHE	SCHRAUBE	TORNILLO
BV133	BV013300	NR	VITE TE TUTTO FILETTO PG DIN 933 CL 8.8 M 3 X 25 Z.BIANCA	SCREW ALL THREAD DIN 933 PG CL 8.8 M 3 X 25 Z. WHITE	VIS ENTIÈREMENT FILETÉE DIN 933 CL 8.8 M 3 X 25 GALVANISATION BLANCHE	SCHRAUBE	TORNILLO
BV134	BV013400	NR	VITE TE PARZIALE FILETTO PG DIN 931 CL 8.8 M 10 X 65 Z.BIANCA	SCREW PARTIAL THREAD DIN 931 PG CL 8.8 M 10 X 65 Z. WHITE	VIS PARTIELLEMENT FILETÉE DIN 931 CL 8.8 M 10 X 65 GALVANISATION BLANCHE	SCHRAUBE	TORNILLO
BV135	BV013500	NR	VITE TCEI PG DIN 912 CL 8.8 M 12 X 50	SCREW DIN 912 CL 9.8 M 12 X 50	VIS DIN 912 CL 8.8 M 12 X 50	SCHRAUBE DIN 912 CL 8.8 M 12 X 50	TORNILLO DIN 912 CL 8.8 M 12 X 50
BV136	BV013600	NR	VITE TSPEI PG DIN 7991 CL 10.9 M 5 X 25 Z.BIANCA	TSPEI PG SCREW DIN 7991 CL 10.9 M 5 X 25 Z. WHITE	VIS DIN 7991 CL 10.9 M 5 X 25 GALVANISATION BLANCHE	SCHRAUBE	TORNILLO



POS	Codice	U.M.	 Descrizione	 Description	 Designation	 Benennung	 Descripción
BV137	BV013700	NR	VITE TCEI PG DIN 912 CL 8.8 M 8 X 30	SCREW DIN 912 CL 8.8 M 8 X 30	VIS DIN 912 CL 8.8 M 8 X 30	SCHRAUBE DIN 912 CL 8.8 M 8 X 30	TORNILLO DIN 912 CL 8.8 M 8 X 30
BV138	BV013800	NR	VITE TC CROCE PG DIN 7985 CL 4.8 M 5 X 10 Z.BIANCA	SCREW DIN 7985 CL 4.8 M 5 X 10	VIS CROIX DIN 7985 CL 4.8 M 5 X 10 GALVANISATION BLANCHE	SCHRAUBE	TORNILLO
BV139	BV013900	NR	VITE TCEI PG DIN 912 CL 8.8 M 4 X 25 Z. BIANCA	SCREW DIN 912 CL 8.8 M 4 X 25 Z.WITHE	VIS DIN 912 CL 8.8 M 4 X 25 GALVANISATION BLANCHE	SCHRAUBE	TONILLO
BV140	BV014000	NR	VITE TE PARZIALE FILETTO PG DIN 931 CL 8.8 M 5 X 70 Z.BIANCA	SCREW PARTIAL THREAD DIN 931 PG CL 8.8 M 5 X 70 Z. WHITE	VIS PARTIELLEMENT FILETÉE DIN 931 CL 8.8 M 5 X 70 GALVANISATION BLANCHE	SCHRAUBE	TORNILLO
BV141	BV014100	NR	VITE TE PARZIALE FILETTO PG DIN 931 CL 8.8 M 12 X 90 Z.BIANCA	SCREW PARTIAL THREAD DIN 931 PG CL 8.8 M 12 X 90 Z. WHITE	VIS PARTIELLEMENT FILETÉE DIN 931 CL 8.8 M 12 X 90 GALVANISATION BLANCHE	SCHRAUBE	TORNILLO
BV142	BV014200	NR	VITE TE PARZIALE FILETTO PG DIN 931 CL 8.8 M 8 X 55 Z.BIANCA	SCREW PARTIAL THREAD DIN 931 PG CL 8.8 M 8 X 55 Z. WHITE	VIS PARTIELLEMENT FILETÉE DIN 931 CL 8.8 M 8 X 55 GALVANISATION BLANCHE	SCHRAUBE	TORNILLO
BV143	BV014300	NR	VITE TSPEI PG DIN 7991 CL 10.9 M 10 X 20 Z.BIANCA	TSPEI PG SCREW DIN 7991 CL 10.9 M 10 X 20 Z. WHITE	VIS DIN 7991 CL 10.9 M 10 X 20 GALVANISATION BLANCHE	SCHRAUBE	TORNILLO
BV144	BV014400	NR	VITE TE TUTTO FILETTO PG DIN 933 CL 8.8 M 12 X 20 Z.BIANCA	SCREW ALL THREAD DIN 933 PG CL 8.8 M 12 X 20 Z. WHITE	VIS ENTIÈREMENT FILETÉE DIN 933 CL 8.8 M 12 X 20 GALVANISATION BLANCHE	SCHRAUBE	TORNILLO
BV145	BV014500	NR	VITE TE TUTTO FILETTO PG DIN 933 CL 8.8 M 12 X 35 Z.BIANCA	SCREW ALL THREAD DIN 933 PG CL 8.8 M 12 X 35 Z. WHITE	VIS ENTIÈREMENT FILETÉE DIN 933 PG CL 8.8 M 12 X 35 Z. BLANC	VOLLGEWINDESCHRAUBE DIN 933 PG CL 8.8 M 12 X 35 Z. WEIß	TORNILLO TOTALMENTE ROSCADO DIN 933 CL 8.8 M 12 X 35 GALVANIZADO BLANCO
BV146	BV014600	NR	VITE TE TUTTO FILETTO PF DIN 961 CL 10.9 M 10 X 1,25 X 25 Z.D.BIANCO	ALL PF THREAD HEX HEAD SCREW DIN 961 CL 10.9 M 10 X 1,25 X 25 Z.BIANCA	VIS ENTIÈREMENT FILETÉE DIN 961 CL 10.9 M 10 X 1,25 X 25 GALVANISÉE BLANCHE	VOLLGEWINDESCHRAUBE DIN 961 CL 10.9 M 10 X 1,25 X 25 Z. WEIß	TORNILLO TOTALMENTE ROSCADO DIN 961 CL 10.9 M 10 X 1,25 X 25 GALVANIZADO BLANCO
BV147	BV014700	NR	VITE TSPEI PARZIALE FILETTO PG DIN 7991 CL 10.9 M 12 X 90 Z.BIANCA	TSPEI PARTIAL THREAD PG SCREW DIN 7991 CL 10.9 M12 X 90 Z. WHITE	VIS TSPEI PG DIN 7991 CL 10.9 M 12 X 90 GALVANISATION BLANCHE	SCHRAUBE	TORNILLO
BV148	BV014800	NR	VITE TSPEI PG DIN 7991 CL 10.9 M 6 X 16 Z.BIANCA	TSPEI PG SCREW DIN 7991 CL 10.9 M6 X 16 Z. WHITE	VIS TSPEI PG DIN 7991 CL 10.9 M 6 X 16 GALVANISATION BLANCHE	SCHRAUBE	TORNILLO

POS	Codice	U.M.	 Descrizione	 Description	 Designation	 Benennung	 Descripción
BV149	BV014900	NR	VITE TBEI PG ISO 7380 CL 10.9 M 6 X 20 Z.BIANCA	HEX SOCKET SCREW ISO 7380 PG CL 10.9 M 6 X 20 Z. WHITE	VIS ISO 7380 CL 10.9 M 6 X 20 GALVANISATION BLANCHE	SCHRAUBE	TORNILLO
BV150	BV015000	NR	VITE TE TUTTO FILETTO PG DIN 933 CL 10.9 M 14 X 40 Z.BIANCA	SCREW ALL THREAD DIN 933 PG CL 10.9 M 14 X 40 Z. WHITE	VIS ENTIÈREMENT FILETÉE DIN 933 CL 10.9 M 14 X 40 GALVANISATION BLANCHE	SCHRAUBE	TORNILLO
BV151	BV015100	NR	VITE TE PARZIALE FILETTO PG DIN 931 CL 8.8 M 10 X 85 Z.BIANCA	SCREW PARTIAL THREAD DIN 931 PG CL 8.8 M 10 X 85 Z. WHITE	VIS PARTIELLEMENT FILETÉE DIN 931 PG CL 8.8 M 10 X 85 Z. BLANC	TEILGEWINDESCHRAUBE DIN 931 PG CL 8.8 M 10 X 85 Z. WEIß	TORNILLO PARCIALMENTE ROSCADO PG DIN 931 CL 8.8 M 10 X 85 GALVANIZADO BLANCO
BV152	BV015200	NR	VITE TE PARZIALE FILETTO PG DIN 931 CL 8.8 M 10 X 75 Z.BIANCA	SCREW PARTIAL THREAD DIN 931 PG CL 8.8 M 10 X 75 Z. WHITE	VIS PARTIELLEMENT FILETÉE DIN 931 PG CL 8.8 M 10 X 75 Z. BLANC	TEILGEWINDESCHRAUBE DIN 931 PG CL 8.8 M 10 X 75 Z. WEIß	TORNILLO PARCIALMENTE ROSCADO PG DIN 931 CL 8.8 M 10 X 75 GALVANIZADO BLANCO
BV154	BV015400	NR	VITE TCEI PG DIN 912 CL 8.8 M 8 X 35	SCREW DIN 912 CL 8.8 M 8 X 35	VIS DIN 912 CL 8.8 M 8 X 35	SCHRAUBE DIN 912 CL 8.8 M 8 X 35	TORNILLO TCEI PG DIN 912 CL 8.8 M 8 X 35
BV155	BV015500	NR	VITE TCEI PG DIN 912 CL 8.8 M 5 X 20 GEOMET 321A	SCREW DIN 912 CL 8.8 M 5 X 20 GEOMET 321A	VIS DIN 912 CL 8.8 M 5 X 20 GEOMET 321A	SCHRAUBE DIN 912 CL 8.8 M 5 X 20 GEOMET 321A	TORNILLO TCEI PG DIN 912 CL 8.8 M 5 X 20 GEOMET 321A
BV156	BV015600	NR	VITE TBEI PG ISO 7380 CL 10.9 M 6 X 25 Z.BIANCA	HEX SOCKET SCREW ISO 7380 PG CL 10.9 M 6 X 25 Z. WHITE	VIS ISO 7380 PG CL 10.9 M 6 X 25 Z. BLANC	SCHRAUBE ISO 7380 PG CL 10.9 M 6 X 25 Z. WEIß	TORNILLO TBEI PG ISO 7380 CL 10.9 M 6 X 25 GALVANIZADO BLANCO
BV157	BV015700	NR	VITE TBEI PG ISO 7380 CL 10.9 M 8 X 20 Z.BIANCA	HEX SOCKET SCREW ISO 7380 PG CL 10.9 M 8 X 20 Z. WHITE	VIS ISO 7380 PG CL 10.9 M 8 X 20 Z. BLANC	TBEI PG SCHRAUBE ISO 7380 CL 10.9 M 8 X 20 Z. WEIß	TORNILLO TBEI PG ISO 7380 CL 10.9 M 8 X 20 GALVANIZADO BLANCO
BV158	BV015800	NR	VITE TBEI PG ISO 7380 CL 10.9 M 6 X 70 Z.BIANCA	HEX SOCKET SCREW ISO 7380 PG CL 10.9 M 6 X 70 Z. WHITE	VIS ISO 7380 PG CL 10.9 M 6 X 70 Z. BLANC	TBEI PG SCHRAUBE ISO 7380 PG CL 10.9 M 6 X 70 Z. WEIß	TORNILLO TBEI PG ISO 7380 CL 10.9 M 6 X 70 GALVANIZADO BLANCO
BV159	BV015900	NR	VITE TBEI PG ISO 7380 CL 10.9 M 10 X 20 Z.BIANCA	HEX SOCKET SCREW ISO 7380 PG CL 10.9 M 10 X 20 Z. WHITE	VIS SO 7380 PG CL 10.9 M 10 X 20 Z. BLANC	TBEI PG SCHRAUBE ISO 7380 PG CL 10.9 M 10 X 20 Z. WEIß	TORNILLO TBEI PG ISO 7380 CL 10.9 M 10 X 20 GALVANIZADO BLANCO
BV160	BV016000	NR	VITE TSPEI PG DIN 7991 CL 10.9 M 4 X 16 Z.BIANCA	TSPEI PG SCREW DIN 7991 CL 10.9 M 4 X 16 Z. WHITE	VIS DIN 7991 CL 10.9 M 4 X 16 Z. WHITE	TSPEI PG SCHRAUBE DIN 7991 CL 10.9 M 4 X 16 Z. WEIß	TORNILLO TSPEI PG DIN 7991 CL 10.9 M 4 X 16 GALVANIZADO BLANCO
BV162	BV016200	NR	VITE TCEI PG DIN 912 CL 12.9 M14 X 45 GEOMET 321A	SCREW DIN 912 CL 12.9 M14 X 45 GEOMET 321A	VIS TCEI PG DIN 912 CL 12.9 M14 X 45 GEOMET 321A	SCHRAUBE TCEI PG DIN 912 CL 12.9 M14 X 45 GEOMET 321A	TORNILLO TCEI PG DIN 912 CL 12.9 M14 X 45 GEOMET 321A





POS	Codice	U.M.	 Descrizione	 Description	 Designation	 Benennung	 Descripción
BV163	BV016300	NR	VITE TCEI PG DIN 912 CL 8.8 M6 X 35	SCREW DIN 912 CL 8.8 M6 X 35	VIS DIN 912 CL 8.8 M6 X 35	SCHRAUBE DIN 912 CL 8.8 M6 X 35	TORNILLO DIN 912 CL 8.8 M6 X 35
BV164	BV016400	NR	VITE TCEI PG DIN 912 CL 8.8 M10 X 35	SCREW DIN 912 CL 8.8 M10 X 35	VIS DIN 912 CL 8.8 M10 X 35	SCHRAUBE DIN 912 CL 8.8 M10 X 35	TORNILLO DIN 912 CL 8.8 M10 X 35
BV165	BV016500	NR	VITE TE TUTTO FILETTO PG DIN 933 CL 8.8 M8 X 12 Z.BIANCA	SCREW ALL THREAD DIN 933 PG CL 8.8 M8 X 12 Z. WHITE	VIS ENTIÈREMENT FILETÉE DIN 933 PG CL 8.8 M8 X 12 Z. BLANC	VOLLGEWINDESCHRAUBE DIN 933 PG CL 8.8 M8 X 12 Z. WEIß	TORNILLO TOTALMENTE ROSCADO PG DIN 933 CL 8.8 M8 X 12 GALVANIZADO BLANCO
BV166	BV016600	NR	VITE TCEI PG DIN 912 CL 8.8 M4 X 20 Z. BIANCA	SCREW DIN 912 CL 8.8 M4 X 20 Z. WITHE	VIS DIN 912 CL 8.8 M4 X 20	SCHRAUBE DIN 912 CL 8.8 M4 X 20	TORNILLO TCEI PG DIN 912 CL 8.8 M4 X 20
BV167	BV016700	NR	VITE TCEI PG DIN 912 CL 8.8 M4 X 20 GEOMET 321A	ALL PF THREAD HEX HEAD SCREW DIN 961 CL 8.8 M 12 X 1,25 X 30 Z.BIANCA	VIS ENTIÈREMENT FILETÉE DIN 961 CL 8.8 M 12 X 1,25 X 30 Z.BLANC	VOLLGEWINDESCHRAUBE DIN 961 CL 8.8 M 12 X 1,25 X 30 Z. WEIß	TORNILLO TOTALMENTE ROSCADO TCEI PG DIN 912 CL 8.8 M4 X 20 GEOMET 321A
BV168	BV016800	NR	VITE TE TUTTO FILETTO PF DIN 961 CL 8.8 M 10 X 1,25 X 30 Z.BIANCA	ALL PF THREAD HEX HEAD SCREW DIN 961 CL 8.8 M 10 X 1,25 X 30 Z.BIANCA	VIS ENTIÈREMENT FILETÉE DIN 961 CL 8.8 M 10 X 1,25 X 30 Z.BLANC	VOLLGEWINDESCHRAUBE DIN 961 CL 8.8 M 10 X 1,25 X 30 Z. WEIß	TORNILLO TOTALMENTE ROSCADO PF DIN 961 CL 8.8 M 10 X 1,25 X 30 GALVANIZADO BLANCO
BV169	BV016900	NR	VITE TCEI PG DIN 912 CL 8.8 M 10 X 1,25 X 30 ZINCATA BIANCA	SCREW DIN 912 CL 8.8 M10 X 1,25 X 30	VIS DIN 912 CL 8.8 M10 X 1,25 X 30	SCHRAUBE DIN 912 CL 8.8 M10 X 1,25 X 30	TORNILLO TCEI PG DIN 912 CL 8.8 M 10 X 1,25 X 30
BV170	BV017000	NR	VITE TE PARZIALE FILETTO PF DIN 960 CL 8.8 M 10 X 1,25 X 60 Z.BIANCA	PARTIAL PF THREAD HEX HEAD SCREW DIN 960 CL 8.8 M 10 X 1,25 X 60 Z.BIANCA	VIS FILETÉE DIN 960 CL 8.8 M 10 X 1,25 X 60 Z.BLANC	VOLLGEWINDESCHRAUBE DIN 960 CL 8.8 M 10 X 1,25 X 60 Z. WEIß	TORNILLO ROSCADO DIN 960 CL 8.8 M 10 X 1,25 X 30 GALVANIZADO BLANCO
BV171	BV017100	NR	VITE TE TUTTO FILETTO PF DIN 961 CL 10.9 M 12 X 1,25 X 25 Z.BIANCA	ALL PF THREAD HEX HEAD SCREW DIN 961 CL 10.9 M 12 X 1,25 X 25 Z.BIANCA	VIS ENTIÈREMENT FILETÉE DIN 961 CL 10.9 M 12 X 1,25 X 25 Z.BLANC	VOLLGEWINDESCHRAUBE DIN 961 CL 10.9 M 12 X 1,25 X 25 Z. WEIß	TORNILLO TOTALMENTE ROSCADO DIN 961 CL 10.9 M 12 X 1,25 X 25 GALVANIZADO BLANCO
BV172	BV017200	NR	VITE TCEI UNC ASME/ANSI B18.3 ASTM A 574 5/8 X 11/2 GEO 321A	VITE TCEI UNC ASME/ANSI B18.3 ASTM A 574 5/8 X 11/2 GEO 321A	VIS TCEI UNC ASME/ANSI B18.3 ASTM A 574 5/8 X 11/2 GEO 321A	SCHRAUBE TCEI UNC ASME/ANSI B18.3 ASTM A 574 5/8 X 11/2 GEO 321A	TORNILLO TCEI UNC ASME/ANSI B18.3 ASTM A 574 5/8 X 11/2 GEO 321A
BV173	BV017300	NR	VITE TE TUTTO FILETTO PG DIN 933 CL 8.8 M12 X 30 Z.BIANCA	SCREW ALL THREAD DIN 933 PG CL 8.8 M12 X 30 Z. WHITE	VIS ENTIÈREMENT FILETÉE DIN 933 PG CL 8.8 M12 X 30 Z. BLANC	VOLLGEWINDESCHRAUBE DIN 933 PG CL 8.8 M12 X 30 Z. WEIß	TORNILLO TOTALMENTE ROSCADO DIN 933 CL 8.8 M12 X 30 GALVANIZADO BLANCO





POS	Codice	U.M.	 Descrizione	 Description	 Designation	 Benennung	 Descripción
BV174	BV017400	NR	VITE TE TUTTO FILETTO PG DIN 933 CL 8.8 M5 X 45 Z.BIANCA	SCREW ALL THREAD DIN 933 PG CL 8.8 M5 X 45 Z. WHITE	VIS ENTIÈREMENT FILETÉE DIN 933 PG CL 8.8 M5 X 45 Z. BLANC	VOLLGEWINDESCHRAUBE DIN 933 PG CL 8.8 M5 X 45 Z. WEIß	TORNILLO TOTALMENTE ROSCADO DIN 933 CL 8.8 M5 X 45 GALVANIZADO BLANCO
BV175	BV017500	NR	VITE TE PARZIALE FILETTO PG DIN 931 CL 8.8 M 12 X 80 Z.BIANCA	SCREW PARTIAL THREAD DIN 931 PG CL 8.8 M12 X 80 Z. WHITE	VIS FILETÉE DIN 931 PG CL 8.8 M12 X 80 Z. BLANC	VOLLGEWINDESCHRAUBE DIN 931 PG CL 8.8 M12 X 80 Z. WEIßE	VIS ROSCADO DIN 931 CL 8.8 M12 X 80 GALVANIZADO BLANCO
BV176	BV017600	NR	VITE TCEI PG DIN 912 CL 8.8 M 6 X 25 Z.BIANCA	SCREW DIN 912 CL 8.8 M6 X 25	VIS DIN 912 CL 8.8 M6 X 25	SCHRAUBE DIN 912 CL 8.8 M6 X 25	TORNILLO TCEI PG DIN 912 CL 8.8 M6 X 25
BV177	BV017700	NR	VITE TE PARZIALE FILETTO PG DIN 931 CL 8.8 M 12 X 85 Z.BIANCA	SCREW PARTIAL THREAD DIN 931 PG CL 8.8 M12 X 85 Z. WHITE	VIS FILETÉE DIN 931 PG CL 8.8 M12 X 85 Z. BLANC	VOLLGEWINDESCHRAUBE DIN 931 PG CL 8.8 M12 X 85 Z. WEIßE	TORNILLO ROSCADO DIN 931 CL 8.8 M12 X 85 GALVANIZADO BLANCO
BV178	BV017800	NR	VITE TE TUTTO FILETTO PG DIN 933 CL 8.8 M8 X 90 Z.BIANCA	SCREW ALL THREAD DIN 933 PG CL 8.8 M8 X 90 Z. WHITE	VIS ENTIÈREMENT FILETÉE DIN 933 PG CL 8.8 M8 X 90 Z. BLANC	VOLLGEWINDESCHRAUBE DIN 933 PG CL 8.8 M8 X 90 Z. WEIßE	TORNILLO TOTALMENTE ROSCADO DIN 933 CL 8.8 M8 X 90 GALVANIZADO BLANCO
BV179	BV017900	NR	VITE TE TUTTO FILETTO PG DIN 933 CL 8.8 M5 X 40 Z.BIANCA	SCREW ALL THREAD DIN 933 PG CL 8.8 M5 X 40 Z. WHITE	VIS ENTIÈREMENT FILETÉE DIN 933 PG CL 8.8 M5 X 40 Z. BLANC	VOLLGEWINDESCHRAUBE DIN 933 PG CL 8.8 M5 X 40 Z. WEIßE	TORNILLO TOTALMENTE ROSCADO PG DIN 933 CL 8.8 M5 X 40 GALVANIZADO BLANCO
BV180	BV018000	NR	VITE TE TUTTO FILETTO PG DIN 933 CL 8.8 M6 X 75 Z.BIANCA	SCREW ALL THREAD DIN 933 PG CL 8.8 M6 X 75 Z. WHITE	VIS ENTIÈREMENT FILETÉE DIN 933 PG CL 8.8 M6 X 75 Z. BLANC	VOLLGEWINDESCHRAUBE DIN 933 PG CL 8.8 M6 X 75 Z. WEIß	TORNILLO TOTALMENTE ROSCADO DIN 933 CL 8.8 M6 X 75 GALVANIZADO BLANCO
BV182	BV018200	NR	VITE TE TUTTO FILETTO PG DIN 933 CL 10.9 M 16 X 70 Z.BIANCA	SCREW ALL THREAD DIN 933 PG CL 10.9 M 16 X 70 Z. WHITE	VIS ENTIÈREMENT FILETÉE DIN 933 CL 10.9 M 16 X 70 GALVANISÉE BLANCHE	VOLLGEWINDESCHRAUBE DIN 933 PG CL 10.9 M 16 X 70 Z. WEIß	TORNILLO TOTALMENTE FILETADO DIN 933 CL 10.9 M 16 X 70 TOTALMENTE ROSCADO
BV183	BV018300	NR	VITE TE TUTTO FILETTO PG DIN 933 CL 8.8 M5 X 10 Z.BIANCA	SCREW ALL THREAD DIN 933 PG CL 8.8 M5 X 10 Z. WHITE	VIS ENTIÈREMENT FILETÉE DIN 933 PG CL 8.8 M5 X 10 Z. BLANC	VOLLGEWINDESCHRAUBE DIN 933 PG CL 8.8 M5 X 10 Z. WEIß	TORNILLO TOTALMENTE ROSCADO DIN 933 CL 8.8 M5 X 10 GALVANIZADO BLANCO
BV184	BV018400	NR	VITE TE TUTTO FILETTO PG DIN 933 CL 8.8 M10 X 16 Z.BIANCA	SCREW ALL THREAD DIN 933 PG CL 8.8 M10 X 16 Z. WHITE	VIS ENTIÈREMENT FILETÉE DIN 933 PG CL 8.8 M10 X 16 Z. BLANC	VOLLGEWINDESCHRAUBE DIN 933 PG CL 8.8 M10 X 16 Z. WEIß	TORNILLO TOTALMENTE ROSCADO DIN 933 CL 8.8 M10 X 16 GALVANIZADO BLANCO
BV185	BV018500	NR	VITE TCEI PG DIN 912 CL 8.8 M 8 X 55 Z.BIANCA	SCREW DIN 912 CL 8.8 M8 X 55	VIS DIN 912 CL 8.8 M8 X 55	SCHRAUBE DIN 912 CL 8.8 M8 X 55	TORNILLO DIN 912 CL 8.8 M8 X 55
BV186	BV018600	NR	VITE TCEI PG DIN 912 CL 12.9 M10 X 30 GEOMET 321A	SCREW DIN 912 CL 12.9 M10 X 30 GEOMET 321A	VIS DIN 912 CL 12.9 M10 X 30 GEOMET 321A	SCHRAUBE DIN 912 CL 12.9 M10 X 30 GEOMET 321A	TORNILLO DIN 912 CL 12.9 M10 X 30 GEOMET 321A

POS	Codice	U.M.	 Descrizione	 Description	 Designation	 Benennung	 Descripción
BV187	BV018700	NR	VITE TCEI PG DIN 912 CL 12.9 M14 X 40 GEOMET 321A	SCREW DIN 912 CL 12.9 M14 X 40 GEOMET 321A	VIS TCEI PG DIN 912 CL 12.9 M14 X 40 GEOMET 321A	SCHRAUBE DIN 912 CL 12.9 M14 X 40 GEOMET 321A	TORNILLO DIN 912 CL 12.9 M14 X 40 GEOMET 321A
BV188	BV018800	NR	VITE TE TUTTO FILETTO PG DIN 933 CL 8.8 M 12 X 60 Z.BIANCA	SCREW ALL THREAD DIN 933 PG CL 8.8 M12 X 60 Z. WHITE	VIS ENTIÈREMENT FILETÉE DIN 933 PG CL 8.8 M12 X 60 Z. BLANC	VOLLGEWINDESCHRAUBE DIN 933 PG CL 8.8 M12 X 60 Z. WEIÙE	VIS TOTALMENTE ROSCADO DIN 933 CL 8.8 M12 X 60 GALVANIZADO BLANCO
BV189	BV018900	NR	VITE TE TUTTO FILETTO PG DIN 933 CL 8.8 M 12 X 55 Z.BIANCA	SCREW ALL THREAD DIN 933 PG CL 8.8 M12 X 55 Z. WHITE	VIS ENTIÈREMENT FILETÉE DIN 933 PG CL 8.8 M12 X 55 Z. BLANC	VOLLGEWINDESCHRAUBE DIN 933 PG CL 8.8 M12 X 55 Z. WEIÙE	VIS TOTALMENTE ROSCADO DIN 933 CL 8.8 M12 X 55 GALVANIZADO BLANCO
BV190	BV019000	NR	VITE TE TUTTO FILETTO PG DIN 933 CL 8.8 M 12 X 50 Z.BIANCA	SCREW ALL THREAD DIN 933 PG CL 8.8 M12 X 50 Z. WHITE	VIS ENTIÈREMENT FILETÉE DIN 933 PG CL 8.8 M12 X 50 Z. BLANC	VOLLGEWINDESCHRAUBE DIN 933 PG CL 8.8 M12 X 50 Z. WEIÙE	VIS TOTALMENTE ROSCADO DIN 933 CL 8.8 M12 X 50 GALVANIZADO BLANCO
BV191	BV019100	NR	VITE TE TUTTO FILETTO PG DIN 933 CL 8.8 M 16 X 50 Z.BIANCA	SCREW ALL THREAD DIN 933 PG CL 8.8 M16 X 50 Z. WHITE	VIS ENTIÈREMENT FILETÉE DIN 933 PG CL 8.8 M16 X 50 Z. BLANC	VOLLGEWINDESCHRAUBE DIN 933 PG CL 8.8 M16 X 50 Z. WEIÙE	VIS TOTALMENTE ROSCADO DIN 933 CL 8.8 M16 X 50 GALVANIZADO BLANCO
BV192	BV019200	NR	VITE TE TUTTO FILETTO PG DIN 933 CL 8.8 M 16 X 55 Z.BIANCA	SCREW ALL THREAD DIN 933 PG CL 8.8 M16 X 55 Z. WHITE	VIS ENTIÈREMENT FILETÉE DIN 933 PG CL 8.8 M16 X 55 Z. BLANC	VOLLGEWINDESCHRAUBE DIN 933 PG CL 8.8 M16 X 55 Z. WEIÙE	VIS TOTALMENTE ROSCADO DIN 933 CL 8.8 M16 X 55 GALVANIZADO BLANCO
BV193	BV019300	NR	VITE TE PARZIALE FILETTO PG DIN 931 CL 8.8 M 10 X 55 Z.BIANCA	SCREW PARTIAL THREAD DIN 931 PG CL 8.8 M 10 X 55 Z. WHITE	VIS PARTIELLEMENT FILETÉE DIN 931 PG CL 8.8 M 10 X 55 Z. BLANC	TEILGEWINDESCHRAUBE DIN 931 PG CL 8.8 M 10 X 55 Z. WEIÙ	TORNILLO PARCIALMENTE ROSCADO PG DIN 931 CL 8.8 M 10 X 55 GALVANIZADO BLANCO
BV194	BV019400	NR	VITE TE PARZIALE FILETTO PG DIN 931 CL 8.8 M 16 X 230 Z.BIANCA	SCREW PARTIAL THREAD DIN 931 PG CL 8.8 M 16 X 230 Z. WHITE	VIS PARTIELLEMENT FILETÉE DIN 931 PG CL 8.8 M 16 X 230 Z. BLANC	TEILGEWINDESCHRAUBE DIN 931 PG CL 8.8 M 16 X 230 Z. WEIÙ	TORNILLO PARCIALMENTE ROSCADO PG DIN 931 CL 8.8 M 16 X 230 GALVANIZADO BLANCO
BV195	BV019500	NR	VITE TE PARZIALE FILETTO PG DIN 931 CL 8.8 M 6 X 50 Z.BIANCA	SCREW PARTIAL THREAD DIN 931 PG CL 8.8 M 6 X 50 Z. WHITE	VIS PARTIELLEMENT FILETÉE DIN 931 PG CL 8.8 M 6 X 50 Z. BLANC	TEILGEWINDESCHRAUBE DIN 931 PG CL 8.8 M 6 X 50 Z. WEIÙ	TORNILLO PARCIALMENTE ROSCADO PG DIN 931 CL 8.8 M 6 X 50 GALVANIZADO BLANCO
BV196	BV019600	NR	VITE TE PARZIALE FILETTO PG DIN 931 CL 8.8 M 6 X 65 Z.BIANCA	SCREW PARTIAL THREAD DIN 931 PG CL 8.8 M 6 X 65 Z. WHITE	VIS PARTIELLEMENT FILETÉE DIN 931 PG CL 8.8 M 6 X 65 Z. BLANC	TEILGEWINDESCHRAUBE DIN 931 PG CL 8.8 M 6 X 65 Z. WEIÙ	TORNILLO PARCIALMENTE ROSCADO PG DIN 931 CL 8.8 M 6 X 65 GALVANIZADO BLANCO
BV197	BV019700	NR	VITE TE PARZIALE FILETTO PG DIN 931 CL 8.8 M 8 X 45 Z.BIANCA	SCREW PARTIAL THREAD DIN 931 PG CL 8.8 M 8 X 45 Z. WHITE	VIS PARTIELLEMENT FILETÉE DIN 931 PG CL 8.8 M 8 X 45 Z. BLANC	TEILGEWINDESCHRAUBE DIN 931 PG CL 8.8 M 8 X 45 Z. WEIÙ	TORNILLO PARCIALMENTE ROSCADO PG DIN 931 CL 8.8 M 8 X 45 GALVANIZADO BLANCO

POS	Codice	U.M.	 Descrizione	 Description	 Designation	 Benennung	 Descripción
BV198	BV019800	NR	VITE TE PARZIALE FILETTO PG DIN 931 CL 8.8 M 8 X 55 Z.BIANCA	SCREW PARTIAL THREAD DIN 931 PG CL 8.8 M 8 X 55 Z. WHITE	VIS PARTIELLEMENT FILETÉE DIN 931 PG CL 8.8 M 8 X 55 Z. BLANC	TEILGEWINDESCHRAUBE DIN 931 PG CL 8.8 M 8 X 55 Z. WEIß	TORNILLO PARCIALMENTE ROSCADO PG DIN 931 CL 8.8 M 8 X 55 GALVANIZADO BLANCO
BV199	BV019900	NR	VITE TE PARZIALE FILETTO PG DIN 931 CL 8.8 M 8 X 60 Z.BIANCA	SCREW PARTIAL THREAD DIN 931 PG CL 8.8 M 8 X 60 Z. WHITE	VIS PARTIELLEMENT FILETÉE DIN 931 PG CL 8.8 M 8 X 60 Z. BLANC	TEILGEWINDESCHRAUBE DIN 931 PG CL 8.8 M 8 X 60 Z. WEIß	TORNILLO PARCIALMENTE ROSCADO PG DIN 931 CL 8.8 M 8 X 60 GALVANIZADO BLANCO
BV200	BV020000	NR	VITE TE TUTTO FILETTO PG DIN 933 CL 10.9 M 16 X 40	SCREW ALL THREAD DIN 933 PG CL 10.9 M 16 X 40	VIS ENTIÈREMENT FILETÉE DIN 933 CL 10.9 M 16 X 40	VOLLGEWINDESCHRAUBE DIN 933 PG CL 10.9 M 16 X 40	TORNILLO TOTALMENTE FILETADO DIN 933 CL 10.9 M 16 X 40
BV201	BV020100	NR	VITE TSPEI PG DIN 7991 CL 10.9 M16 X 45 Z.BIANCA	TSPEI PG SCREW DIN 7991 CL 10.9 M16 X 45 Z. WHITE	VIS DIN 7991 CL 10.9 M16 X 45 Z. WHITE	TSPEI PG SCHRAUBE DIN 7991 CL 10.9 M16 X 45 Z. WEIß	TORNILLO TSPEI PG DIN 7991 CL 10.9 M 16 X 45 GALVANIZADO BLANCO
BV202	BV020200	NR	VITE TCEI PG DIN 912 CL 12.9 M3 X 12 ZINC. IRIDESCENTE FE/ZN5IVS	SCREW DIN 912 CL 12.9 M3 X 12 ZINC. IRIDESCENTE FE/ZN5IVS	VIS DIN 912 CL 12.9 M3 X 12 ZINC. IRIDESCENTE FE/ZN5IVS	SCHRAUBE DIN 912 CL 12.9 M3 X 12 ZINC. IRIDESCENTE FE/ZN5IVS	TORNILLO DIN 912 CL 12.9 M3 X 12 ZINC. IRIDESCENTE FE/ZN5IVS
BV203	BV020300	NR	VITE TC CROCE PG DIN 7985 CL 4.8 M M 3 X 5 Z.BIANCA	SCREW DIN 7985 CL 4.8 M M 3 X 5	VIS CROIX DIN 7985 CL 4.8 M M 3 X 5 GALVANISATION BLANCHE	SCHRAUBE	TORNILLO
BV204	BV020400	NR	VITE TC CROCE PG DIN 7985 CL 4.8 M M 3 X 8 Z.BIANCA	SCREW DIN 7985 CL 4.8 M M 3 X 8	VIS CROIX DIN 7985 CL 4.8 M M 3 X 8 GALVANISATION BLANCHE	SCHRAUBE	TORNILLO
BV205	BV020500	NR	VITE TTQST DIN 603 CL 4.8 M 8 X 35 Z.BIANCA	TTQST SCREW DIN 603 CL 4.8 M 8 X 35 Z. WHITE			
BV206	BV020600	NR	VITE TC CROCE PG DIN 7985 CL 4.8 M M 5 X 80 Z.BIANCA	SCREW DIN 7985 CL 4.8 M M 5 X 80	VIS CROIX DIN 7985 CL 4.8 M M 5 X 80 GALVANISATION BLANCHE	SCHRAUBE	TORNILLO
BV207	BV020700	NR	VITE TE PARZIALE FILETTO PG DIN 931 CL 8.8 M 10 X 80 Z.BIANCA	SCREW PARTIAL THREAD DIN 931 PG CL 8.8 M 10 X 80 Z. WHITE	VIS PARTIELLEMENT FILETÉE DIN 931 PG CL 8.8 M 10 X 80 Z. BLANC	TEILGEWINDESCHRAUBE DIN 931 PG CL 8.8 M 10 X 80 Z. WEIß	TORNILLO PARCIALMENTE ROSCADO PG DIN 931 CL 8.8 M 10 X 80 GALVANIZADO BLANCO
BV208	BV020800	NR	VITE TE TUTTO FILETTO PG DIN 933 CL 8.8 M 16 X 35 Z.D.BIANCA	SCREW ALL THREAD DIN 933 PG CL 8.8 M 16 X 35 ZD WHITE	VIS ENTIÈREMENT FILETÉE DIN 933 CL 8.8 M 16 X 35 GALVANISATION BLANCHE	SCHRAUBE	TORNILLO





POS	Codice	U.M.	 Descrizione	 Description	 Designation	 Benennung	 Descripción
BV209	BV020900	NR	VITE TE PARZIALE FILETTO PG DIN 931 CL 8.8 M 10 X 95 Z.D.BIANCA	SCREW PARTIAL THREAD DIN 931 PG CL 8.8 M 10 X 95 Z. WHITE	VIS PARTIELLEMENT FILETÉE DIN 931 PG CL 8.8 M 10 X 95 Z. BLANC	TEILGEWINDESCHRAUBE DIN 931 PG CL 8.8 M 10 X 95 Z. WEIß	TORNILLO PARCIALMENTE ROSCADO PG DIN 931 CL 8.8 M 10 X 95 GALVANIZADO BLANCO
BV210	BV021000	NR	VITE TE TUTTO FILETTO PG DIN 933 CL 8.8 M 6 X 14 Z.D.BIANCA	SCREW ALL THREAD DIN 933 PG CL 8.8 M 6 X 14 ZD WHITE	VIS ENTIÈREMENT FILETÉE DIN 933 CL 8.8 M 6 X 14 GALVANISATION BLANCHE	SCHRAUBE	TORNILLO
BV211	BV021100	NR	VITE TE TUTTO FILETTO PG DIN 933 CL 8.8 M 12 X 25 Z.D.BIANCA	SCREW ALL THREAD DIN 933 PG CL 8.8 M 12 X 25 ZD WHITE	VIS ENTIÈREMENT FILETÉE DIN 933 CL 8.8 M 12 X 25 GALVANISATION BLANCHE	SCHRAUBE	TORNILLO
BV212	BV021200	NR	VITE TE TUTTO FILETTO PG DIN 933 CL 8.8 M 4 X 14 Z.D.BIANCA	SCREW ALL THREAD DIN 933 PG CL 8.8 M 4 X 14 ZD WHITE	VIS ENTIÈREMENT FILETÉE DIN 933 CL 8.8 M 4 X 14 GALVANISATION BLANCHE	SCHRAUBE	TORNILLO
BV213	BV021300	NR	VITE TE TUTTO FILETTO PG DIN 933 CL 10.9 M 16 X 60	SCREW ALL THREAD DIN 933 PG CL 10.9 M 16 X 60	VIS ENTIÈREMENT FILETÉE DIN 933 CL 10.9 M 16 X 60	SCHRAUBE	TORNILLO
BV214	BV021400	NR	VITE TE PARZIALE FILETTO PG DIN 931 CL 8.8 M 6 X 100 Z.D.BIANCA	SCREW PARTIAL THREAD DIN 931 PG CL 8.8 M 6 X 100 Z. WHITE	VIS PARTIELLEMENT FILETÉE DIN 931 PG CL 8.8 M 6 X 100 Z. BLANC	TEILGEWINDESCHRAUBE DIN 931 PG CL 8.8 M 6 X 100 Z. WEIß	TORNILLO PARCIALMENTE ROSCADO PG DIN 931 CL 8.8 M 6 X 100 GALVANIZADO BLANCO
BV215	BV021500	NR	VITE TE PARZIALE FILETTO PG DIN 931 CL 10.9 M 16 X 110	SCREW PARTIAL THREAD DIN 931 PG CL 10.9 M 16 X 110	VIS PARTIELLEMENT FILETÉE DIN 931 CL 10.9 M 16 X 110	SCHRAUBE	TORNILLO
BV216	BV021600	NR	VITE TE PARZIALE FILETTO PG DIN 931 CL 10.9 M 16 X 240 Z.D.BIANCA	SCREW PARTIAL THREAD DIN 931 PG CL 10.9 M 16 X 240 ZD WHITE	VIS PARTIELLEMENT FILETÉE DIN 931 CL 10.9 M 16 X 240 GALVANISATION BLANCHE	SCHRAUBE	TORNILLO
BV217	BV021700	NR	VITE TSPEI PG DIN 7991 CL 10.9 M 8 X 30 Z.BIANCA	TSPEI PG SCREW DIN 7991 CL 10.9 M8 X 30 Z. WHITE	VIS TSPEI PG DIN 7991 CL 10.9 M 8 X 30 GALVANISATION BLANCHE	SCHRAUBE	TORNILLO
BV218	BV021800	NR	VITE TSPEI PG DIN 7991 CL 10.9 M 5 X 6 Z.BIANCA	TSPEI PG SCREW DIN 7991 CL 10.9 M5 X 6 Z. WHITE	VIS TSPEI PG DIN 7991 CL 10.9 M 5 X 6 GALVANISATION BLANCHE	SCHRAUBE	TORNILLO
BV219	BV021900	NR	VITE TSPEI PG DIN 7991 CL 10.9 M 5 X 70 Z.BIANCA	TSPEI PG SCREW DIN 7991 CL 10.9 M5 X 70 Z. WHITE	VIS TSPEI PG DIN 7991 CL 10.9 M 5 X 70 GALVANISATION BLANCHE	SCHRAUBE	TORNILLO





POS	Codice	U.M.	 Descrizione	 Description	 Designation	 Benennung	 Descripción
BV220	BV022000	NR	VITE TSPEI PG DIN 7991 CL 10.9 M 12 X 35 Z.BIANCA	TSPEI PG SCREW DIN 7991 CL 10.9 M12 X 35 Z. WHITE	VIS TSPEI PG DIN 7991 CL 10.9 M 12 X 35 GALVANISATION BLANCHE	SCHRAUBE	TORNILLO
BV221	BV022100	NR	VITE TCEI PG DIN 912 CL 12.9 M10 X 20 GEOMET 321A	SCREW DIN 912 CL 12.9 M10 X 20 GEOMET 321A	VIS DIN 912 CL 12.9 M10 X 20 GEOMET 321A	SCHRAUBE DIN 912 CL 12.9 M10 X 20 GEOMET 321A	TORNILLO DIN 912 CL 12.9 M10 X 20 GEOMET 321A
BV222	BV022200	NR	VITE TCEI PG DIN 912 CL 12.9 M8 X 90 GEOMET 321A	SCREW DIN 912 CL 12.9 M8 X 90 GEOMET 321A	VIS DIN 912 CL 12.9 M8 X 90 GEOMET 321A	SCHRAUBE DIN 912 CL 12.9 M8 X 90 GEOMET 321A	TORNILLO DIN 912 CL 12.9 M8 X 90 GEOMET 321A
BV223	BV022300	NR	VITE TCEI PG DIN 912 CL 12.9 M3 X 5 ZINC.	SCREW DIN 912 CL 12.9 M3 X 5 ZINC.	VIS DIN 912 CL 12.9 M3 X 5 ZINC.	SCHRAUBE DIN 912 CL 12.9 M3 X 5 ZINC.	TORNILLO DIN 912 CL 12.9 M3 X 5 ZINC.
BV224	BV022400	NR	VITE TBEI PG ISO 7380 CL 10.9 M 8 X 22 Z.BIANCA	HEX SOCKET SCREW ISO 7380 PG CL 10.9 M 8 X 22 Z. WHITE	VIS ISO 7380 PG CL 10.9 M 8 X 22 Z. BLANC	SCHRAUBE ISO 7380 PG CL 10.9 M 8 X 22 Z. WEIß	TORNILLO TBEI PG ISO 7380 CL 10.9 M 8 X 22 GALVANIZADO BLANCO
BV225	BV022500	NR	VITE TE PARZIALE FILETTO PG DIN 931 CL 8.8 M 10 X 100 Z.BIANCA	SCREW PARTIAL THREAD DIN 931 PG CL 8.8 M 10 X 100 Z. WHITE	VIS PARTIELLEMENT FILETÉE DIN 931 PG CL 8.8 M 10 X 100 Z. BLANC	TEILGEWINDESCHRAUBE DIN 931 PG CL 8.8 M 10 X 100 Z. WEIß	TORNILLO PARCIALMENTE ROSCADO PG DIN 931 CL 8.8 M 10 X 100 GALVANIZADO BLANCO
BV226	BV022600	NR	VITE TE PARZIALE FILETTO PG DIN 931 CL 8.8 M 10 X 110 Z.BIANCA	SCREW PARTIAL THREAD DIN 931 PG CL 8.8 M 10 X 110 Z. WHITE	VIS PARTIELLEMENT FILETÉE DIN 931 PG CL 8.8 M 10 X 110 Z. BLANC	TEILGEWINDESCHRAUBE DIN 931 PG CL 8.8 M 10 X 110 Z. WEIß	TORNILLO PARCIALMENTE ROSCADO PG DIN 931 CL 8.8 M 10 X 110 GALVANIZADO BLANCO
BV227	BV022700	NR	VITE TE PARZIALE FILETTO PG DIN 931 CL 10.9 M 12 X 45 Z.D.BIANCA	SCREW PARTIAL THREAD DIN 931 PG CL 10.9 M 12 X 45 ZD WHITE	VIS PARTIEL FILETÉE DIN 931 CL 10.9 M 12 X 45 GALVANISATION BLANCHE	SCHRAUBE	TORNILLO
BV228	BV022800	NR	VITE TE TUTTO FILETTO PG DIN 933 CL 10.9 M 14 X 35 Z.D.BIANCA	SCREW ALL THREAD DIN 933 PG CL 10.9 M 14 X 35 ZD WHITE	VIS ENTIÈREMENT FILETÉE DIN 933 CL 10.9 M 14 X 35 GALVANISATION BLANCHE	SCHRAUBE	TORNILLO
BV229	BV022900	NR	VITE TSPEI PG DIN 7991 CL 10.9 M 12 X 30 Z.BIANCA	TSPEI PG SCREW DIN 7991 CL 10.9 M12 X 30 Z. WHITE	VIS TSPEI PG DIN 7991 CL 10.9 M 12 X 30 GALVANISATION BLANCHE	SCHRAUBE	TORNILLO
BV230	BV023000	NR	VITE TE FLANGIATA TUTTO FILETTO PG DIN 6921 CL 8.8 M 5 X 12 ZINCONICKEL NERO +SIGILLANTE	FLANGE SCREW ALL THREAD DIN 6921 PG CL 8.8 M 5 X 12 ZINCNICKEL BLACK +SEALANT	VIS	SCHRAUBE	TORNILLO

POS	Codice	U.M.	 Descrizione	 Description	 Designation	 Benennung	 Descripción
BV231	BV023100	NR	VITE TE FLANGIATA TUTTO FILETTO PG DIN 6921 CL 8.8 M 6 X 16 ZINCONICKEL NERO +SIGILLANTE	FLANGE SCREW ALL THREAD DIN 6921 PG CL 8.8 M 6 X 16 ZINCNICKEL BLACK +SEALANT	VIS	SCHRAUBE	TORNILLO
BV232	BV023200	NR	VITE TE TUTTO FILETTO PG DIN 933 CL 8.8 M 5 X 25 Z.D.BIANCA	SCREW ALL THREAD DIN 933 PG CL 8.8 M 5 X 25 ZD WHITE	VIS ENTIÈREMENT FILETÉE DIN 933 CL 8.8 M 5 X 25 GALVANISATION BLANCHE	SCHRAUBE	TORNILLO
BV233	BV023300	NR	VITE TE TUTTO FILETTO PG DIN 933 CL 8.8 M 8 X 130 Z.D.BIANCA	SCREW ALL THREAD DIN 933 PG CL 8.8 M 8 X 130 ZD WHITE	VIS ENTIÈREMENT FILETÉE DIN 933 CL 8.8 M 8 X 130 GALVANISATION BLANCHE	SCHRAUBE	TORNILLO
BV234	BV023400	NR	VITE TBEI PG ISO 7380 CL 10.9 M 10 X 30 Z.BIANCA	HEX SOCKET SCREW ISO 7380 PG CL 10.9 M 10 X 30 Z. WHITE	VIS ISO 7380 PG CL 10.9 M 10 X 30 Z. BLANC	SCHRAUBE ISO 7380 PG CL 10.9 M10 X 30 Z. WEIß	TORNILLO TBEI PG ISO 7380 CL 10.9 M 10 X 30 GALVANIZADO BLANCO
BV235	BV023500	NR	VITE TE TUTTO FILETTO PG DIN 933 CL 10.9 M 16 X 35 Z.D.BIANCA	SCREW ALL THREAD DIN 933 PG CL 10.9 M 16 X 35 ZD WHITE	VIS ENTIÈREMENT FILETÉE DIN 933 CL 10.9 M 16 X 35 GALVANISATION BLANCHE	SCHRAUBE	TORNILLO
BV236	BV023600	NR	VITE TE PARZIALE FILETTO PG DIN 931 CL 8.8 M 6 X 45 Z.BIANCA	SCREW PARTIAL THREAD DIN 931 PG CL 8.8 M 6 X 45 Z. WHITE	VIS PARTIELLEMENT FILETÉE DIN 931 PG CL 8.8 M 6 X 45 Z. BLANC	TEILGEWINDESCHRAUBE DIN 931 PG CL 8.8 M 6 X 45 Z. WEIß	TORNILLO PARCIALMENTE ROSCADO PG DIN 931 CL 8.8 M 6 X 45 GALVANIZADO BLANCO
BV237	BV023700	NR	VITE TE TUTTO FILETTO PG DIN 933 CL 10.9 M 12 X 30 Z.D.BIANCA	SCREW ALL THREAD DIN 933 PG CL 10.9 M 12 X 30 ZD WHITE	VIS ENTIÈREMENT FILETÉE DIN 933 CL 10.9 M 12 X 30 GALVANISATION BLANCHE	SCHRAUBE	TORNILLO
BV238	BV023800	NR	VITE TE PARZIALE FILETTO PG DIN 931 CL 8.8 M 16 X 90 Z.BIANCA	SCREW PARTIAL THREAD DIN 931 PG CL 8.8 M 16 X 90 Z. WHITE	VIS PARTIELLEMENT FILETÉE DIN 931 PG CL 8.8 M 16 X 90 Z. BLANC	TEILGEWINDESCHRAUBE DIN 931 PG CL 8.8 M 16 X 90 Z. WEIß	TORNILLO PARCIALMENTE ROSCADO PG DIN 931 CL 8.8 M 16 X 90 GALVANIZADO BLANCO
BV239	BV023900	NR	VITE TE PARZIALE FILETTO PG DIN 931 CL 8.8 M 12 X 65 Z.BIANCA	SCREW PARTIAL THREAD DIN 931 PG CL 8.8 M 12 X 65 Z. WHITE	VIS PARTIELLEMENT FILETÉE DIN 931 PG CL 8.8 M 12 X 65 Z. BLANC	TEILGEWINDESCHRAUBE DIN 931 PG CL 8.8 M 12 X 65 Z. WEIß	TORNILLO PARCIALMENTE ROSCADO PG DIN 931 CL 8.8 M 12 X 65 GALVANIZADO BLANCO
BV240	BV024000	NR	VITE TC CROCE PG DIN 7985 CL 4.8 M 5 X 20 Z.BIANCA	SCREW DIN 7985 CL 4.8 M 5 X 20	VIS CROIX DIN 7985 CL 4.8 M 5 X 20 GALVANISATION BLANCHE	SCHRAUBE	TORNILLO





POS	Codice	U.M.	 Descrizione	 Description	 Designation	 Benennung	 Descripción
BV241	BV024100	NR	VITE TSPEI PG DIN 7991 CL 10.9 M 10 X 35 Z.BIANCA	TSPEI PG SCREW DIN 7991 CL 10.9 M 10 X 35 Z. WHITE	VIS TSPEI PG DIN 7991 CL 10.9 M 10 X 35 GALVANISATION BLANCHE	SCHRAUBE	TORNILLO
BV242	BV024200	NR	VITE TSPEI PG DIN 7991 CL 10.9 M 6 X 12 Z.BIANCA	TSPEI PG SCREW DIN 7991 CL 10.9 M 6 X 12 Z. WHITE	VIS TSPEI PG DIN 7991 CL 10.9 M 6 X 12 GALVANISATION BLANCHE	SCHRAUBE	TORNILLO
BV243	BV024300	NR	VITE TE PARZIALE FILETTO PG DIN 931 CL 8.8 M 12 X 150 Z.BIANCA	SCREW PARTIAL THREAD DIN 931 PG CL 8.8 M 12 X 150 Z. WHITE	VIS PARTIELLEMENT FILETÉE DIN 931 PG CL 8.8 M 12 X 150 Z. BLANC	TEILGEWINDESCHRAUBE DIN 931 PG CL 8.8 M 12 X 150 Z. WEIß	TORNILLO PARCIALMENTE ROSCADO PG DIN 931 CL 8.8 M 12 X 150 GALVANIZADO BLANCO
BV244	BV024400	NR	VITE TCEI PG DIN 912 CL 8.8 M5 X 50 ZINGATA BIANCA	SCREW DIN 912 CL 8.8 M5 X 50	VIS DIN 912 CL 8.8 M5 X 50	SCHRAUBE DIN 912 CL 8.8 M5 X 50	TORNILLO DIN 912 CL 8.8 M5 X 50
BV245	BV024500	NR	VITE TE PARZIALE FILETTO PG DIN 931 CL 8.8 M 8 X 110 Z.BIANCA	SCREW PARTIAL THREAD DIN 931 PG CL 8.8 M 8 X 110 Z. WHITE	VIS PARTIELLEMENT FILETÉE DIN 931 PG CL 8.8 M 8 X 110 Z. BLANC	TEILGEWINDESCHRAUBE DIN 931 PG CL 8.8 M 8 X 110 Z. WEIß	TORNILLO PARCIALMENTE ROSCADO PG DIN 931 CL 8.8 M 8 X 110 GALVANIZADO BLANCO
BV246	BV024600	NR	VITE TE PARZIALE FILETTO PG DIN 931 CL 8.8 M 8 X 40 Z.BIANCA	SCREW PARTIAL THREAD DIN 931 PG CL 8.8 M 8 X 40 Z. WHITE	VIS PARTIELLEMENT FILETÉE DIN 931 PG CL 8.8 M 8 X 40 Z. BLANC	TEILGEWINDESCHRAUBE DIN 931 PG CL 8.8 M 8 X 40 Z. WEIß	TORNILLO PARCIALMENTE ROSCADO PG DIN 931 CL 8.8 M 8 X 40 GALVANIZADO BLANCO
BV247	BV024700	NR	VITE TE TUTTO FILETTO PG DIN 933 CL 8.8 M 5 X 50 Z.D.BIANCA	SCREW ALL THREAD DIN 933 PG CL 8.8 M 5 X 50 ZD WHITE	VIS ENTIÈREMENT FILETÉE DIN 933 CL 8.8 M 5 X 50 GALVANISATION BLANCHE	SCHRAUBE	TORNILLO
BV248	BV024800	NR	VITE TCEI PG DIN 912 CL 8.8 M5 X 18 Z. BIANCA	SCREW DIN 912 CL 8.8 M5 X 18 Z. WHITE	VIS DIN 912 CL 8.8 M5 X 18	SCHRAUBE DIN 912 CL 8.8 M5 X 18	TORNILLO DIN 912 CL 8.8 M5 X 18
BV249	BV024900	NR	VITE TSPEI PG DIN 7991 CL 10.9 M 5 X 65 Z.BIANCA	TSPEI PG SCREW DIN 7991 CL 10.9 M 5 X 65 Z. WHITE	VIS TSPEI PG DIN 7991 CL 10.9 M 5 X 65 GALVANISATION BLANCHE	SCHRAUBE	TORNILLO
BV251	BV025100	NR	VITE TSPEI PG DIN 7991 CL 10.9 M 8 X 35 Z.BIANCA	TSPEI PG SCREW DIN 7991 CL 10.9 M 8 X 35 Z. WHITE	VIS TSPEI PG DIN 7991 CL 10.9 M 8 X 35 GALVANISATION BLANCHE	SCHRAUBE	TORNILLO
BV252	BV025200	NR	VITE TE TUTTO FILETTO PG DIN 933 CL 10.9 M 12 X 40 Z.D.BIANCA	SCREW ALL THREAD DIN 933 PG CL 10.9 M 12 X 40 ZD WHITE	VIS ENTIÈREMENT FILETÉE DIN 933 CL 10.9 M 12 X 40 GALVANISATION BLANCHE	SCHRAUBE	TORNILLO

POS	Codice	U.M.	 Descrizione	 Description	 Designation	 Benennung	 Descripción
BV253	BV025300	NR	VITE TBEI PG ISO 7380 M 6 X 55 Z.BIANCA	HEX SOCKET SCREW ISO 7380 PG M 6 X 55 Z. WHITE	VIS ISO 7380 PG M 6 X 55 Z. BLANC	SCHRAUBE ISO 7380 PG M 6 X 55 Z. WEIß	TORNILLO TBEI PG ISO 7380 M 6 X 55 GALVANIZADO BLANCO
BV254	BV025400	NR	VITE TE TUTTO FILETTO PG DIN 933 CL 10.9 M 10 X 35 Z.D.BIANCA	SCREW ALL THREAD DIN 933 PG CL 10.9 M 10 X 35 ZD WHITE	VIS ENTIÈREMENT FILETÉE DIN 933 CL 10.9 M 10 X 35 GALVANISATION BLANCHE	SCHRAUBE	TORNILLO
BV255	BV025500	NR	VITE TE TUTTO FILETTO PG DIN 933 CL 12.9 M 14 X 55 Z.D.BIANCA	SCREW ALL THREAD DIN 933 PG CL 12.9 M 14 X 55 ZD WHITE	VIS ENTIÈREMENT FILETÉE DIN 933 CL 12.9 M 14 X 55 GALVANISATION BLANCHE	SCHRAUBE	TORNILLO
BV256	BV025600	NR	VITE TESTA SVASATA CROCE AUTOFILETTANTE 6 X25	SCREW HEAD CROSS COUNTERSUNK SELF TAPPING 6 X 25			
BV257	BV025700	NR	VITE TE TUTTO FILETTO PG DIN 933 CL 8.8 M14 X 30 Z.BIANCA	SCREW ALL THREAD DIN 933 PG CL 8.8 M14 X 30 Z. WHITE	VIS ENTIÈREMENT FILETÉE DIN 933 PG CL 8.8 M14 X 30 Z. BLANC	VOLLGEWINDESCHRAUBE DIN 933 PG CL 8.8 M14 X 30 Z. WEIß	TORNILLO TOTALMENTE ROSCADO PG DIN 933 CL 8.8 M14 X 30 GALVANIZADO BLANCO
BV258	BV025800	NR	VITE TE TUTTO FILETTO PG DIN 933 CL 10.9 M 12 X 35 Z.D.BIANCA	SCREW ALL THREAD DIN 933 PG CL 10.9 M 12 X 35 ZD WHITE	VIS ENTIÈREMENT FILETÉE DIN 933 CL 10.9 M 12 X 35 GALVANISATION BLANCHE	SCHRAUBE	TORNILLO
BV259	BV025900	NR	VITE TE TUTTO FILETTO PG DIN 933 CL 8.8 M 16 X 45 Z.BIANCA	SCREW ALL THREAD DIN 933 PG CL 8.8 M16 X 45 Z. WHITE	VIS ENTIÈREMENT FILETÉE DIN 933 PG CL 8.8 M16 X 45 Z. BLANC	VOLLGEWINDESCHRAUBE DIN 933 PG CL 8.8 M16 X 45 Z. WEIßE	VIS TOTALMENTE ROSCADO DIN 933 CL 8.8 M16 X 45 GALVANIZADO BLANCO
BV260	BV026000	NR	VITE TCEI PG DIN 912 CL 10.9 M 12 X 30 ZINCATA BIANCA	SCREW DIN 912 CL 10.9 M 12 X 30	VIS DIN 912 CL 12.9 M 10 X 30	SCHRAUBE DIN 912 CL 10.9 M 12 X 30	TORNILLO TCEI PG DIN 912 CL 10.9 M 12 X 30
BV261	BV026100	NR	VITE TCEI PG DIN 912 CL 10.9 M 12 X 20 ZINCATA BIANCA	SCREW DIN 912 CL 10.9 M 12 X 20	VIS DIN 912 CL 12.9 M 10 X 20	SCHRAUBE DIN 912 CL 10.9 M 12 X 20	TORNILLO TCEI PG DIN 912 CL 10.9 M 12 X 20
BV262	BV026200	NR	VITE TCEI PG DIN 912 CL 12.9 M14 X 35 GEOMET 321A	SCREW DIN 912 CL 12.9 M14 X 35 GEOMET 321A	VIS TCEI PG DIN 912 CL 12.9 M14 X 35 GEOMET 321A	SCHRAUBE DIN 912 CL 12.9 M14 X 35 GEOMET 321A	TORNILLO DIN 912 CL 12.9 M14 X 35 GEOMET 321A
BV263	BV026300	NR	VITE TCEI PG DIN 912 CL 12.9 M14 X 3 GEOMET 321A	SCREW DIN 912 CL 12.9 M14 X 3 GEOMET 321A	VIS TCEI PG DIN 912 CL 12.9 M14 X 3 GEOMET 321A	SCHRAUBE DIN 912 CL 12.9 M14 X 3 GEOMET 321A	TORNILLO DIN 912 CL 12.9 M14 X 30 GEOMET 321A
BV264	BV026400	NR	VITE TSPEI PG DIN 7991 CL 10.9 M 12 X 25 Z.BIANCA	TSPEI PG SCREW DIN 7991 CL 10.9 M12 X 25 Z. WHITE	VIS TSPEI PG DIN 7991 CL 10.9 M 12 X 25 GALVANISATION BLANCHE	SCHRAUBE	TORNILLO

POS	Codice	U.M.	 Descrizione	 Description	 Designation	 Benennung	 Descripción
BV265	BV026500	NR	VITE TE PARZIALE FILETTO PG DIN 931 CL 10.9 M 16 X 180 GEOMET 321A	SCREW PARTIAL THREAD DIN 931 PG CL 10.9 M 16 X 180 GEOMET 321A	VIS PARTIELLEMENT FILETÉE DIN 931 CL 10.9 M 16 X 180 GEOMET 321A	SCHRAUBE	TORNILLO
BV266	BV026600	NR	VITE TE TUTTO FILETTO PG DIN 933 CL 8.8 M8 X 10 Z.BIANCA	SCREW ALL THREAD DIN 933 PG CL 8.8 M8 X 10 Z. WHITE	VIS ENTIÈREMENT FILETÉE DIN 933 PG CL 8.8 M8 X 10 Z. BLANC	VOLLGEWINDESCHRAUBE DIN 933 PG CL 8.8 M8 X 10 Z. WEIß	TORNILLO TOTALMENTE ROSCADO PG DIN 933 CL 8.8 M8 X 10 GALVANIZADO BLANCO
BV267	BV026700	NR	VITE TCEI PG DIN 912 CL 8.8 M 12 X 40	SCREW DIN 912 CL 9.8 M 12 X 40	VIS DIN 912 CL 8.8 M 12 X 40	SCHRAUBE DIN 912 CL 8.8 M 12 X 40	TORNILLO DIN 912 CL 8.8 M 12 X 40
BV268	BV026800	NR	VITE TE PARZIALE FILETTO PG DIN 931 CL 8.8 M 12 X 140 Z.BIANCA	SCREW PARTIAL THREAD DIN 931 PG CL 8.8 M 12 X 140 Z. WHITE	VIS PARTIELLEMENT FILETÉE DIN 931 PG CL 8.8 M 12 X 140 Z. BLANC	TEILGEWINDESCHRAUBE DIN 931 PG CL 8.8 M 12 X 140 Z. WEIß	TORNILLO PARCIALMENTE ROSCADO PG DIN 931 CL 8.8 M 12 X 140 GALVANIZADO BLANCO
BV269	BV026900	NR	VITE TC CROCE PG DIN 7985 CL 4.8 M 6 X 25 Z.BIANCA	SCREW DIN 7985 CL 4.8 M 6 X 25	VIS CROIX DIN 7985 CL 4.8 M 6 X 25 GALVANISATION BLANCHE	SCHRAUBE	TORNILLO
BV270	BV027000	NR	VITE TCEI PG DIN 912 CL 8.8 M 12 X 40	SCREW DIN 912 CL 9.8 M 12 X 40	VIS DIN 912 CL 8.8 M 12 X 40	SCHRAUBE DIN 912 CL 8.8 M 12 X 40	TORNILLO DIN 912 CL 8.8 M 12 X 40
BV271	BV027100	NR	TCEI UNC ASME/ANSI B18.3 ASTM A 574 1/2 X 1"1/4 GEOMET	TCEI UNC ASME/ANSI B18.3 ASTM A 574 1/2 X 1"1/4 GEOMET	TCEI UNC ASME/ANSI B18.3 ASTM A 574 1/2 X 1"1/4 GEOMET	TCEI UNC ASME/ANSI B18.3 ASTM A 574 1/2 X 1"1/4 GEOMET	TCEI UNC ASME/ANSI B18.3 ASTM A 574 1/2 X 1"1/4 GEOMET
BV272	BV027200	NR	TCEI UNC ASME/ANSI B18.3 ASTM A 574 1/4-20 X 1"1/2 GEOMET	TCEI UNC ASME/ANSI B18.3 ASTM A 574 1/4-20 X 1"1/2 GEOMET	TCEI UNC ASME/ANSI B18.3 ASTM A 574 1/4-20 X 1"1/2 GEOMET	TCEI UNC ASME/ANSI B18.3 ASTM A 574 1/4-20 X 1"1/2 GEOMET	TCEI UNC ASME/ANSI B18.3 ASTM A 574 1/4-20 X 1"1/2 GEOMET
BV273	BV027300	NR	VITE TE PARZIALE FILETTO PG DIN 931 CL 8.8 M 12 X 70 Z.BIANCA	SCREW PARTIAL THREAD DIN 931 PG CL 8.8 M 12 X 70 Z. WHITE	VIS PARTIELLEMENT FILETÉE DIN 931 PG CL 8.8 M 12 X 70 Z. BLANC	TEILGEWINDESCHRAUBE DIN 931 PG CL 8.8 M 12 X 70 Z. WEIß	TORNILLO PARCIALMENTE ROSCADO PG DIN 931 CL 8.8 M 12 X 70 GALVANIZADO BLANCO
BV274	BV027400	NR	VITE TE TUTTO FILETTO PG DIN 933 CL 8.8 M 5 X 20 Z.D.BIANCA	SCREW ALL THREAD DIN 933 PG CL 8.8 M 5 X 20 ZD WHITE	VIS ENTIÈREMENT FILETÉE DIN 933 CL 8.8 M 5 X 20 GALVANISATION BLANCHE	SCHRAUBE	TORNILLO
BV275	BV027500	NR	VITE TSPEI PG DIN 7991 CL 10.9 M 6 X 70 Z.BIANCA	TSPEI PG SCREW DIN 7991 CL 10.9 M 6 X 70 Z. WHITE	VIS DIN 7991 CL 10.9 M 6 X 70 Z. BLANC	TSPEI PG SCHRAUBE DIN 7991 CL 10.9 M 6 X 70 Z. WEIß	TORNILLO TSPEI PG DIN 7991 CL 10.9 M 6 X 70 GALVANIZADO BLANCO
BV276	BV027600	NR	VITE TCEI PG DIN 912 CL 8.8 M 5 X 14 Z.BIANCA	SCREW DIN 912 PG CL 8.8 M 5 X 14 Z. WHITE	VIS DIN 912 CL 8.8 M 5 X 14 GALVANISATION BLANCHE	SCHRAUBE	TORNILLO





POS	Codice	U.M.	 Descrizione	 Description	 Designation	 Benennung	 Descripción
BV277	BV027700	NR	VITE TBEI PG ISO 7380 CL 10.9 M 10 X 35 Z.BIANCA	HEX SOCKET SCREW ISO 7380 PG CL 10.9 M 10 X 35 Z. WHITE	VIS ISO 7380 PG CL 10.9 M 10 X 35 Z. BLANC	SCHRAUBE ISO 7380 PG CL 10.9 M 10 X 35 Z. WEIß	TORNILLO TBEI PG ISO 7380 CL 10.9 M 10 X 35 GALVANIZADO BLANCO
BV278	BV027800	NR	VITE TE PARZIALE FILETTO PG DIN 931 CL 10.9 M 16 X 60	SCREW PARTIAL THREAD DIN 931 PG CL 10.9 M 16 X 60	VIS TE PARTIELLEMENT FILETÉE PG DIN 931 CL 10.9 M 16 X 60	TEILGEWINDESCHRAUBE DIN 931 PG CL 10.9 M 16 X 60	TORNILLO PARCIALMENTE ROSCADO PG DIN 931 CL 10.9 M 16 X 60
BV279	BV027900	NR	VITE TE PARZIALE FILETTO PG DIN 931 CL 8.8 M 12 X 60 Z.BIANCA	SCREW PARTIAL THREAD DIN 931 PG CL 8.8 M 12 X 60 Z. WHITE	VIS PARTIELLEMENT FILETÉE DIN 931 PG CL 8.8 M 12 X 60 Z. BLANC	TEILGEWINDESCHRAUBE DIN 931 PG CL 8.8 M 12 X 60 Z. WEIß	TORNILLO PARCIALMENTE ROSCADO PG DIN 931 CL 8.8 M 12 X 60 GALVANIZADO BLANCO
BV280	BV028000	NR	VITE TE PARZIALE FILETTO PG DIN 931 CL 8.8 M 12 X 55 Z.BIANCA	SCREW PARTIAL THREAD DIN 931 PG CL 8.8 M 12 X 55 Z. WHITE	VIS PARTIELLEMENT FILETÉE DIN 931 PG CL 8.8 M 12 X 55 Z. BLANC	TEILGEWINDESCHRAUBE DIN 931 PG CL 8.8 M 12 X 55 Z. WEIß	TORNILLO PARCIALMENTE ROSCADO PG DIN 931 CL 8.8 M 12 X 55 GALVANIZADO BLANCO
BV281	BV028100	NR	VITE TE PARZIALE FILETTO PG DIN 931 CL 8.8 M 14 X 45 Z.BIANCA	SCREW PARTIAL THREAD DIN 931 PG CL 8.8 M 14 X 45 Z. WHITE	VIS PARTIELLEMENT FILETÉE DIN 931 PG CL 8.8 M 14 X 45 Z. BLANC	TEILGEWINDESCHRAUBE DIN 931 PG CL 8.8 M 14 X 45 Z. WEIß	TORNILLO PARCIALMENTE ROSCADO PG DIN 931 CL 8.8 M 14 X 45 GALVANIZADO BLANCO
BV282	BV028200	NR	VITE TE TUTTO FILETTO PG DIN 933 CL 8.8 M 8 X 55 Z.BIANCA	SCREW ALL THREAD DIN 933 PG CL 8.8 M 8 X 55 Z. WHITE	VIS TE ENTIÈREMENT FILETÉE PG DIN 933 CL 8.8 M 8 X 55 Z.BLANC	VOLLGEWINDESCHRAUBE DIN 933 PG CL 8.8 M 8 X 55 Z. WEIß	TORNILLO TOTALMENTE ROSCADO PG DIN 933 CL 8.8 M 8 X 55 GALVANIZADO BLANCO
BV283	BV028300	NR	VITE TCEI INTERAMENTE FILETTATA PG CL 8.8 M 8 X 45 Z.BIANCA	SCREW TCEI FULLY THREADED PG CL 8.8 M 8 X 45 Z. WHITE	VIS	SCHRAUBE	TORNILLO
BV284	BV028400	NR	VITE TCEI PG DIN 912 CL 8.8 M 4 X 35 Z.BIANCA	SCREW TCEI DIN 912 CL 8.8 M 4 X 35 Z. WHITE	VIS	SCHRAUBE	TORNILLO
BV285	BV028500	NR	VITE TCEI PG DIN 912 CL 8.8 M 4 X 50 Z.BIANCA	SCREW TCEI DIN 912 CL 8.8 M 4 X 50 Z. WHITE	VIS	SCHRAUBE	TORNILLO
BV286	BV028600	NR	VITE TCEI PG DIN 912 CL 8.8 M 5 X 25 Z.BIANCA	SCREW TCEI DIN 912 CL 8.8 M 5 X 25 Z. WHITE	VIS	SCHRAUBE	TORNILLO
BV287	BV028700	NR	VITE TCEI PG DIN 912 CL 8.8 M 5 X 50 GEO 321 A	SCREW TCEI DIN 912 CL 8.8 M 5 X 50 GEO 321 A	VIS	SCHRAUBE	TORNILLO
BV293	BV029300	NR	VITE TCEI PG DIN 912 CL 8.8 M 8 X 90 Z.BIANCA	SCREW TCEI DIN 912 CL 8.8 M 8 X 90 Z. WHITE	VIS	SCHRAUBE	TORNILLO

POS	Codice	U.M.	 Descrizione	 Description	 Designation	 Benennung	 Descripción
BV294	BV029400	NR	VITE TCEI PG DIN 912 CL 8.8 M 10 X 16 Z.BIANCA	SCREW TCEI DIN 912 CL 8.8 M 10 X 16 Z. WHITE	VIS	SCHRAUBE	TORNILLO
BV295	BV029500	NR	VITE TCEI PG DIN 912 CL 8.8 M 10 X 20 Z.BIANCA	SCREW TCEI DIN 912 CL 8.8 M 10 X 20 Z. WHITE	VIS	SCHRAUBE	TORNILLO
BV297	BV029700	NR	VITE TCEI PG DIN 912 CL 8.8 M 10 X 40 Z.BIANCA	SCREW TCEI DIN 912 CL 8.8 M 10 X 40 Z. WHITE	VIS	SCHRAUBE	TORNILLO
BV298	BV029800	NR	VITE TCEI PG DIN 912 CL 8.8 M 10 X 65 Z.BIANCA	SCREW TCEI DIN 912 CL 8.8 M 10 X 65 Z. WHITE	VIS	SCHRAUBE	TORNILLO
BV299	BV029900	NR	VITE TCEI PG DIN 912 CL 8.8 M 10 X 120 Z.BIANCA	SCREW TCEI DIN 912 CL 8.8 M 10 X 120 Z. WHITE	VIS	SCHRAUBE	TORNILLO
BV300	BV030000	NR	VITE TCEI PG DIN 912 CL 8.8 M 12 X 30 Z.BIANCA	VITE TCEI PG DIN 912 CL 8.8 M 12 X 30 Z.BIANCA	VIS	SCHRAUBE	TORNILLO
BV301	BV030100	NR	VITE TCEI UNC ASME/ANSI B18.3 ASTM A 574 1/4 X 1 "3/4	TCEI SCREW UNC ASME / ANSI B18.3 ASTM A 574 1/4 X 1 "3/4	VIS	SCHRAUBE	TORNILLO
BV303	BV030300	NR	VITE TCEI UNC ASME/ANSI B18.3 ASTM A 574 5/16 X 3/4	TCEI SCREW UNC ASME / ANSI B18.3 ASTM A 574 5/16 X 3/4	VIS	SCHRAUBE	TORNILLO
BV304	BV030400	NR	VITE TCEI PG DIN 912 CL 12.9 M 10 X 75	SCREW TCEI DIN 912 CL 12.9 M 10 X 75	VIS	SCHRAUBE	TORNILLO
BV305	BV030500	NR	VITE TCEI PG DIN 912 CL 12.9 M 14 X 55	SCREW TCEI DIN 912 CL 12.9 M 14 X 55	VIS	SCHRAUBE	TORNILLO
BV306	BV030600	NR	VITE TCEI BASSA PG DIN 7984 CL 10.9 M 12 X 20 Z.D.BIANCA	LOW TCEI SCREW DIN 7984 CL 10.9 M 12 X 20 Z.D. WHITE	VIS	SCHRAUBE	TORNILLO
BV307	BV030700	NR	VITE TSPEI TUTTO FILETTO PG DIN 7991 CL 10.9 M 12 X 90 ZIC. BIANCO DEID.	TSPEI SCREW FULLY THREADED DIN 7991 CL 10.9 M 12 X 90 ZIC. DEID WHITE.	VIS	SCHRAUBE	TORNILLO
BV308	BV030800	NR	VITE TSPEI TUTTO FIL. PG DIN 7991 CL 10.9 M 14 X 100 ZIC. BIANCO DEID.	TSPEI SCREW ALL THREAD DIN 7991 CL 10.9 M 14 X 100 ZIC. DEID WHITE.	VIS	SCHRAUBE	TORNILLO
BV309	BV030900	NR	VITE TSPEI PG DIN 7991 CL 10.9 M 4 X 25 ZIC. BIANCO DEID.	SCREW TSPEI DIN 7991 CL 10.9 M 4 X 25 ZIC. DEID WHITE.	VIS	SCHRAUBE	TORNILLO
BV310	BV031000	NR	VITE TSPEI PG DIN 7991 CL 10.9 M 5 X 40	SCREW TSPEI DIN 7991 CL 10.9 M 5 X 40	VIS	SCHRAUBE	TORNILLO





POS	Codice	U.M.	 Descrizione	 Description	 Designation	 Benennung	 Descripción
BV311	BV031100	NR	VITE TSPEI PG DIN 7991 CL 10.9 M 5 X 80 ZIC. BIANCO DEID.	SCREW TSPEI DIN 7991 CL 10.9 M 5 X 80 ZIC. DEID WHITE.	VIS	SCHRAUBE	TORNILLO
BV312	BV031200	NR	VITE TSPEI PG DIN 7991 CL 10.9 M 8 X 20 ZIC. BIANCO DEID.	SCREW TSPEI DIN 7991 CL 10.9 M 8 X 20 ZIC. DEID WHITE.	VIS	SCHRAUBE	TORNILLO
BV313	BV031300	NR	VITE TSPEI PG DIN 7991 CL 10.9 M 16 X 50 ZIC. BIANCO DEID.	SCREW TSPEI DIN 7991 CL 10.9 M 16 X 50 ZIC. DEID WHITE.	VIS	SCHRAUBE	TORNILLO
BV315	BV031500	NR	VITE TE UNC ANSI B18.2.1 GR.5 5/8 X 3"1/2	SCREW TE UNC ANSI B18.2.1 GR.5 5/8 X 3 1/2 "	VIS	SCHRAUBE	TORNILLO
BV316	BV031600	NR	VITE TE TUTTO FILETTO PG DIN 933 CL 8.8 M 4 X 40 Z.BIANCA	ALL SCREW TE THREAD DIN 933 CL 8.8 M 4 X 40 Z. WHITE	VIS	SCHRAUBE	TORNILLO
BV317	BV031700	NR	VITE TE TUTTO FILETTO PG DIN 933 CL 8.8 M 5 X 55 Z.BIANCA	ALL SCREW TE THREAD DIN 933 CL 8.8 M 5 X 55 Z. WHITE	VIS	SCHRAUBE	TORNILLO
BV318	BV031800	NR	VITE TE TUTTO FILETTO PG DIN 933 CL 8.8 M 6 X 10 Z.BIANCA	ALL SCREW TE THREAD DIN 933 CL 8.8 M 6 X 10 Z. WHITE	VIS	SCHRAUBE	TORNILLO
BV319	BV031900	NR	VITE TE TUTTO FILETTO PG DIN 933 CL 8.8 M 6 X 50 Z.BIANCA	ALL SCREW TE THREAD DIN 933 CL 8.8 M 6 X 50 Z. WHITE	VIS	SCHRAUBE	TORNILLO
BV320	BV032000	NR	VITE TE TUTTO FILETTO PG DIN 933 CL 8.8 M 8 X 45 Z.BIANCA	ALL SCREW TE THREAD DIN 933 CL 8.8 M 8 X 45 Z. WHITE	VIS	SCHRAUBE	TORNILLO
BV321	BV032100	NR	VITE TE TUTTO FILETTO PG DIN 933 CL 8.8 M 8 X 65 Z.BIANCA	ALL SCREW TE THREAD DIN 933 CL 8.8 M 8 X 65 Z. WHITE	VIS	SCHRAUBE	TORNILLO
BV322	BV032200	NR	VITE TE TUTTO FILETTO PG DIN 933 CL 8.8 M 8 X 80 Z.BIANCA	ALL SCREW TE THREAD DIN 933 CL 8.8 M 8 X 80 Z. WHITE	VIS	SCHRAUBE	TORNILLO
BV323	BV032300	NR	VITE TE TUTTO FILETTO PG DIN 933 CL 8.8 M 10 X 75 Z.BIANCA	ALL SCREW TE THREAD DIN 933 CL 8.8 M 10 X 75 Z. WHITE	VIS	SCHRAUBE	TORNILLO





POS	Codice	U.M.	 Descrizione	 Description	 Designation	 Benennung	 Descripción
BV324	BV032400	NR	VITE TE TUTTO FILETTO PG DIN 933 CL 8.8 M 12 X 75 Z.BIANCA	ALL SCREW TE THREAD DIN 933 CL 8.8 M 12 X 75 Z. WHITE	VIS	SCHRAUBE	TORNILLO
BV326	BV032600	NR	VITE TE PARZIALE FILETTO PG DIN 931 CL 8.8 M 8 X 90 Z.BIANCA	SCREW TE PARTIAL THREAD DIN 931 CL 8.8 M 8 X 90 Z. WHITE	VIS	SCHRAUBE	TORNILLO
BV327	BV032700	NR	VITE TE PARZIALE FILETTO PG DIN 931 CL 8.8 M 8 X 100 Z.BIANCA	SCREW TE PARTIAL THREAD DIN 931 CL 8.8 M 8 X 100 Z. WHITE	VIS	SCHRAUBE	TORNILLO
BV329	BV032900	NR	VITE TE PARZIALE FILETTO PG DIN 931 CL 8.8 M 10 X 40 Z.BIANCA	SCREW TE PARTIAL THREAD DIN 931 CL 8.8 M 10 X 40 Z. WHITE	VIS	SCHRAUBE	TORNILLO
BV330	BV033000	NR	VITE TE PARZIALE FILETTO PG DIN 931 CL 8.8 M 10 X 45 Z.BIANCA	SCREW TE PARTIAL THREAD DIN 931 CL 8.8 M 10 X 45 Z. WHITE	VIS	SCHRAUBE	TORNILLO
BV331	BV033100	NR	VITE TE PARZIALE FILETTO PG DIN 931 CL 8.8 M 10 X 60 Z.BIANCA	SCREW TE PARTIAL THREAD DIN 931 CL 8.8 M 10 X 60 Z. WHITE	VIS	SCHRAUBE	TORNILLO
BV332	BV033200	NR	VITE TE PARZIALE FILETTO PG DIN 931 CL 8.8 M 12 X 40 Z.BIANCA	SCREW TE PARTIAL THREAD DIN 931 CL 8.8 M 12 X 40 Z. WHITE	VIS	SCHRAUBE	TORNILLO
BV333	BV033300	NR	VITE TE PARZIALE FILETTO PG DIN 931 CL 8.8 M 12 X 45 Z.BIANCA	SCREW TE PARTIAL THREAD DIN 931 CL 8.8 M 12 X 45 Z. WHITE	VIS	SCHRAUBE	TORNILLO
BV334	BV033400	NR	VITE TE PARZIALE FILETTO PG DIN 931 CL 8.8 M 12 X 50 Z.BIANCA	SCREW TE PARTIAL THREAD DIN 931 CL 8.8 M 12 X 50 Z. WHITE	VIS	SCHRAUBE	TORNILLO
BV337	BV033700	NR	VITE TE PARZIALE FILETTO PG DIN 931 CL 8.8 M 14 X 60 Z.BIANCA	SCREW TE PARTIAL THREAD DIN 931 CL 8.8 M 14 X 60 Z. WHITE	VIS	SCHRAUBE	TORNILLO
BV338	BV033800	NR	VITE TE PARZIALE FILETTO PG DIN 931 CL 8.8 M 14 X 120 Z.BIANCA	SCREW TE PARTIAL THREAD DIN 931 CL 8.8 M 14 X 120 Z. WHITE	VIS	SCHRAUBE	TORNILLO



POS	Codice	U.M.	 Descrizione	 Description	 Designation	 Benennung	 Descripción
BV339	BV033900	NR	VITE TE PARZIALE FILETTO PG DIN 931 CL 8.8 M 16 X 50 Z.BIANCA	SCREW TE PARTIAL THREAD DIN 931 CL 8.8 M 16 X 50 Z. WHITE	VIS	SCHRAUBE	TORNILLO
BV340	BV034000	NR	VITE TE PARZIALE FILETTO PG DIN 931 CL 8.8 M 16 X 65 Z.BIANCA	SCREW TE PARTIAL THREAD DIN 931 CL 8.8 M 16 X 65 Z. WHITE	VIS	SCHRAUBE	TORNILLO
BV341	BV034100	NR	VITE TE TUTTO FILETTO PF DIN 961 CL 8.8 M 8 X 1 X 35 Z.BIANCA	ALL SCREW TE THREAD DIN 961 CL 8.8 M 8 X 1 X 35 Z. WHITE	VIS	SCHRAUBE	TORNILLO
BV342	BV034200	NR	VITE TE TUTTO FILETTO PF DIN 961 CL 8.8 M 20 X 1,5 X 35 Z.BIANCO	ALL SCREW TE THREAD DIN 961 CL 8.8 M 20 X 1.5 X 35 Z. WHITE	VIS	SCHRAUBE	TORNILLO
BV344	BV034400	NR	VITE TE TUTTO FILETTO PG DIN 933 CL 10.9 M 10 X 30 Z.D.BIANCA	ALL SCREW TE THREAD DIN 933 CL 10.9 M 10 X 30 Z.D. WHITE	VIS	SCHRAUBE	TORNILLO
BV346	BV034600	NR	VITE TE TUTTO FILETTO PG DIN 933 CL 10.9 M 16 X 65 GEO 321 A	ALL SCREW TE THREAD DIN 933 CL 10.9 M 16 X 65 GEO 321 A	VIS	SCHRAUBE	TORNILLO
BV347	BV034700	NR	VITE TE PARZIALE FILETTO PG DIN 931 CL 10.9 M 12 X 40 Z.D.BIANCA	SCREW TE PARTIAL THREAD DIN 931 CL 10.9 M 12 X 40 Z.D. WHITE	VIS	SCHRAUBE	TORNILLO
BV348	BV034800	NR	VITE TE PARZIALE FILETTO PG DIN 931 CL 10.9 M 12 X 75 Z.D.BIANCA	SCREW TE PARTIAL THREAD DIN 931 CL 10.9 M 12 X 75 Z.D. WHITE	VIS	SCHRAUBE	TORNILLO
BV349	BV034900	NR	VITE TE PARZIALE FILETTO PG DIN 931 CL 10.9 M 16 X 45 Z.D.BIANCA	SCREW TE PARTIAL THREAD DIN 931 CL 10.9 M 16 X 45 Z.D. WHITE	VIS	SCHRAUBE	TORNILLO
BV350	BV035000	NR	VITE TE PARZIALE FILETTO PG DIN 931 CL 10.9 M 16 X 75 Z.D.BIANCA	SCREW TE PARTIAL THREAD DIN 931 CL 10.9 M 16 X 75 Z.D. WHITE	VIS	SCHRAUBE	TORNILLO
BV351	BV035100	NR	VITE TE PARZIALE FILETTO PG DIN 931 CL 10.9 M 16 X 180	SCREW TE PARTIAL THREAD DIN 931 CL 10.9 M 16 X 180	VIS	SCHRAUBE	TORNILLO

POS	Codice	U.M.	 Descrizione	 Description	 Designation	 Benennung	 Descripción
BV352	BV035200	NR	VITE TE PARZIALE FILETTO PG DIN 931 CL 10.9 M 16 X 230 GEO 321 A	SCREW TE PARTIAL THREAD DIN 931 CL 10.9 M 16 X 230 GEO 321 A	VIS	SCHRAUBE	TORNILLO
BV354	BV035400	NR	VITE TE TUTTO FILETTO PF DIN 961 CL 10.9 M 12 X 1,25 X 35 Z.D.BIANCA	ALL SCREW TE THREAD DIN 961 CL 10.9 M 12 X 1.25 X 35 Z.D. WHITE	VIS	SCHRAUBE	TORNILLO
BV355	BV035500	NR	VITE TC CROCE PG DIN 7985 CL 4.8 M 4 X 10 Z.BIANCA	SCREW TC DIN 7985 CROSS CL 4.8 M 4 X 10 Z. WHITE	VIS	SCHRAUBE	TORNILLO
BV356	BV035600	NR	VITE TC CROCE PG DIN 7985 CL 4.8 M 5 X 22 Z.BIANCA	SCREW TC DIN 7985 CROSS CL 4.8 M 5 X 22 Z. WHITE	VIS	SCHRAUBE	TORNILLO
BV359	BV035900	NR	VITE TE 8.8 ZINCATE M 6 X 65 PARZIALE	SCREW TE 8.8 GALVANIZED M 6 X 65 PARTIAL	VIS	SCHRAUBE	TORNILLO
BV360	BV036000	NR	VITE TE 8.8 ZINCATE M 14 X 65 PARZIALE	SCREW TE 8.8 GALVANIZED M 14 X 65 PARTIAL	VIS	SCHRAUBE	TORNILLO
BV361	BV036100	NR	VITE TBEI PG ISO 7380 CL 10.9 M 5 X 20 Z.BIANCA	HEX SOCKET SCREW ISO 7380 PG CL 10.9 M 5 X 20 Z. WHITE	VIS ISO 7380 CL 10.9 M 5 X 20 GALVANISATION BLANCHE	SCHRAUBE	TORNILLO
BV362	BV036200	NR	VITE TSPEI PG DIN 7991 CL 10.9 M 6 X 35 Z.BIANCA	SCREW DIN 7991 CL 10.9 M 6 X 35 Z. WHITE			
BV363	BV036300	NR	VITE TC CROCE PG DIN 7985 CL 4.8 M 6 X 12 Z.BIANCA	CROSS HEAD SCREW DIN 7985 PG CL 4.8 M 6 X 12 Z. WHITE	VIS DIN 7985 CL 4.8 M 6 X 12 GALVANISATION BLANCHE	SCHRAUBE	TORNILLO
BV364	BV036400	NR	VITE TE PARZIALE FILETTO PG DIN 931 CL 10.9 M 16 X 160	SCREW PARTIAL THREAD DIN 931 PG CL 10.9 M 16 X 160	VIS TE PARTIELLEMENT FILETÉE PG DIN 931 CL 10.9 M 16 X 60	TEILGEWINDESCHRAUBE DIN 931 PG CL 10.9 M 16 X 160	TORNILLO PARCIALMENTE ROSCADO PG DIN 931 CL 10.9 M 16 X 160
BV365	BV036500	NR	VITE TSPEI PG DIN 7991 CL 10.9 M 10 X 25 Z.BIANCA	TSPEI PG SCREW DIN 7991 CL 10.9 M 10 X 25 Z. WHITE	VIS DIN 7991 CL 10.9 M 10 X 25 GALVANISATION BLANCHE	SCHRAUBE	TORNILLO
BV366	BV036600	NR	VITE TE TUTTO FILETTO PF DIN 961 CL 8.8 M 20 X 1,5 X 35 Z.BIANCO	ALL SCREW TE THREAD DIN 961 CL 8.8 M 20 X 1.5 X 35 Z. WHITE	VIS	SCHRAUBE	TORNILLO
BV367	BV036700	NR	VITE TE PARZIALE FILETTO PG DIN 931 CL 10.9 M 16 X 120	SCREW PARTIAL THREAD DIN 931 PG CL 10.9 M 16 X 120	VIS PARTIELLEMENT FILETÉE DIN 931 CL 10.9 M 16 X 120	SCHRAUBE	TORNILLO
BV368	BV036800	NR	VITE TSPEI PG DIN 7991 CL 10.9 M 8 X 16 Z.BIANCA	SCREW DIN 7991 CL 10.9 M 8 X 16 Z. WHITE	VIS DIN 7991 CL 10.9 M 8 X 16 GALVANISATION BLANCHE		





POS	Codice	U.M.	 Descrizione	 Description	 Designation	 Benennung	 Descripción
BV369	BV036900	NR	VITE TE PARZIALE FILETTO PG DIN 931 CL 8.8 M 6 X 90 Z.BIANCA	SCREW THREAD DIN 931 PG CL 8.8 M 6 X 90 Z. WHITE	VIS FILETÉE DIN 931 CL 8.8 M 6 X 90 GALVANISÉE BLANCHE	VOLLGEWINDESCHRAUBE DIN 931 PG CL 8.8 M 6 X 90 Z. WEIß	TORNILLO ROSCADO DIN 931 CL 8.8 M 6 X 90 GALVANIZADO BLANCO
BV370	BV037000	NR	VITE TBEI PG ISO 7380 CL 10.9 M 8 X 30 Z.BIANCA	HEX SOCKET SCREW ISO 7380 PG CL 10.9 M 8 X 30 Z. WHITE	VIS ISO 7380 PG CL 10.9 M 8 X 30 Z. BLANC	TBEI PG SCHRAUBE ISO 7380 CL 10.9 M 8 X 30 Z. WEIß	TORNILLO TBEI PG ISO 7380 CL 10.9 M 8 X 30 GALVANIZADO BLANCO
BV371	BV037100	NR	VITE TE TUTTO FILETTO PG DIN 933 CL 8.8 M 5 X 30 Z.BIANCA	SCREW ALL THREAD DIN 933 PG CL 8.8 M 5 X 30 Z. WHITE	VIS TE ENTIÈREMENT FILETÉE PG DIN 933 CL 8.8 M 5 X 30 Z.BLANC	VOLLGEWINDESCHRAUBE DIN 933 PG CL 8.8 M 5 X 30 Z. WEIß	TORNILLO TOTALMENTE ROSCADO PG DIN 933 CL 8.8 M 5 X 30 GALVANIZADO BLANCO
BV372	BV037200	NR	VITE TE TUTTO FILETTO PG DIN 933 CL 8.8 M 5 X 35 Z.BIANCA	SCREW ALL THREAD DIN 933 PG CL 8.8 M 5 X 35 Z. WHITE	VIS TE ENTIÈREMENT FILETÉE PG DIN 933 CL 8.8 M 5 X 35 Z.BLANC	VOLLGEWINDESCHRAUBE DIN 933 PG CL 8.8 M 5 X 35 Z. WEIß	TORNILLO TOTALMENTE ROSCADO PG DIN 933 CL 8.8 M 5 X 35 GALVANIZADO BLANCO
BV373	BV037300	NR	VITE TSPEI PG DIN 7991 CL 10.9 M 5 X 10 Z.BIANCA	TSPEI PG SCREW DIN 7991 CL 10.9 M 5 X 10 Z. WHITE	VIS DIN 7991 CL 10.9 M 5 X 10 GALVANISATION BLANCHE	SCHRAUBE	TORNILLO
BV374	BV037400	NR	VITE TE TUTTO FILETTO PG DIN 931 CL 8.8 M 20 X 130 Z.BIANCA	SCREW THREAD DIN 931 PG CL 8.8 M 20 X 130	VIS FILETÉE DIN 931 CL 8.8 M 20 X 130	SCHRAUBE	TORNILLO
BV375	BV037500	NR	VITE TSPEI PG DIN 7991 CL 10.9 M 8 X 120 Z.BIANCA	SCREW DIN 7991 CL 10.9 M 8 X 120 Z. WHITE	VIS DIN 7991 CL 10.9 M 8 X 120 GALVANISATION BLANCHE		
BV376	BV037600	NR	VITE TCEI PARZIALE FILETTO PG DIN 912 CL 8.8 M 6 X 65 Z.BIANCA	SCREW DIN 912 M6 X 65 CL 8.8 Z. WHITE	VIS DIN 912 CL 8.8 M 6 X 65 GALVANISATION BLANCHE	SCHRAUBE	TORNILLO
BV377	BV037700	NR	VITE TCEI PARZIALE FILETTO PG DIN 912 CL 8.8 M 6 X 85 Z.BIANCA	SCREW DIN 912 M6 X 85 CL 8.8 Z. WHITE	VIS DIN 912 CL 8.8 M 6 X 85 GALVANISATION BLANCHE	SCHRAUBE	TORNILLO
BV378	BV037800	NR	VITE TE TUTTO FILETTO PG DIN 933 INOX A2 M 4 X 25	SCREW ALL THREAD DIN 933 PG CL 8.8 M 4 X 25 INOX	VIS ENTIÈREMENT FILETÉE DIN 933 CL 8.8 M 4 X 25 INOX	SCHRAUBE	TORNILLO
BV379	BV037900	NR	VITE TBEI PG ISO 7380 CL 10.9 M 5 X 10 Z.BIANCA	HEX SOCKET SCREW ISO 7380 PG CL 10.9 M 5 X 10 Z. WHITE	VIS ISO 7380 CL 10.9 M 5 X 10 GALVANISATION BLANCHE	SCHRAUBE	TORNILLO





POS	Codice	U.M.	 Descrizione	 Description	 Designation	 Benennung	 Descripción
RB1	RB000100	NR	DADO PER OGIVA Ø=12	NUT FOR OGIVA Ø = 12	ÉCROU POUR OGIVE Ø=12	SCHRAUBENMUTTER FÜR OGIVA Ø = 12	TUERCA PARA OJIVA Ø=12
RD1	RD000100	NR	RACCORDO CORPO A "T" EO F(DKOL)-M-M 8L	FITTING BODY A "T" EO F (DKOL) M-M-8L	RACCORD CORP "T" EO F (DKOL) M-M-8L	T-ANSCHLUSSSTÜCK EO F (DKOL) M-M-8L	UNIÓN EN "T" EO F(DKOL)-M-M 8L
RD2	RD000200	NR	RACCORDO CORPO A "T" EO F(DKOL)-M-M 10L	FITTING BODY A "T" EO F (DKOL) M-M-10L	RACCORD EN "T" EO F(DKOL)-M-M 10L	ANSCHLUSS	CONEXION
RD3	RD000300	NR	RACCORDO CORPO A "T" EO F(DKOL)-M-M 12L	FITTING BODY A "T" EO F (DKOL) M-M-12L	RACCORD CORP "T" EO F(DKOL)-M-M 12L	T-ANSCHLUSSSTÜCK EO F (DKOL) M-M-12L	UNIÓN EN "T" EO F(DKOL)-M-M 12L
RD4	RD000400	NR	RACCORDO CORPO A "T" EO F(DKOL)-M-M 15L	FITTING BODY A "T" EO F (DKOL) M-M-15L	RACCORD CORPS EN "T" EO F(DKOL)-M-M 15L	T-ANSCHLUSSSTÜCK EO F (DKOL) M-M-15L	UNIÓN EN "T" EO F(DKOL)-M-M 15L
RD5	RD000500	NR	RACCORDO CORPO A "T" EO M-F(DKOL)-M 10L	FITTING BODY A "T" EO M-F (DKOL) M-10L	RACCORD CORPS EN "T" EO M-F (DKOL) M-10L	T-ANSCHLUSSSTÜCK EO M-F (DKOL) M-10L	UNIÓN EN "T" EO M-F(DKOL)-M 10L
RD6	RD000600	NR	RACCORDO CORPO A "T" EO M-F(DKOL)-M 12L	FITTING BODY A "T" EO M-F (DKOL) M-12L	RACCORD EN "T" EO M-F(DKOL)-M 12L	ANSCHLUSS	CONEXION
RD7	RD000700	NR	RACCORDO CORPO A "T" EO 8L M 14*1.5	FITTING BODY A "T" EO 8L M 14 * 1.5	RACCORD EN "T" EO 8L M 14*1.5	ANSCHLUSS	CONEXION
RD8	RD000800	NR	RACCORDO CORPO A "T" EO 10L M 16*1.5	FITTING BODY A "T" M 10L EO 16 * 1.5	RACCORD EN "T" EO 10L M 16*1.5	ANSCHLUSS	CONEXION
RD9	RD000900	NR	RACCORDO CORPO A "T" EO 28L M 36*2	FITTING BODY A "T" M 28L EO 36 * 2	RACCORD CORPS EN "T" M 28L EO 36 * 2	T-ANSCHLUSSSTÜCK M 28L EO 36 * 2	UNIÓN EN "T" EO 28L M 36*2
RD10	RD001000	NR	RACCORDO CORPO A "T" EO 28L M 36*2	FITTING BODY A "T" EO M-F (DKOL) M-10L	RACCORD CORPS EN "T" EO M-F (DKOL) M-10L	T-ANSCHLUSSSTÜCK EO M-F (DKOL) M-10L	UNIÓN EN "T" EO 28L M 36*2
RD11	RD001100	NR	RACCORDO CORPO A "T" EO M-F(DKOL)-M 10L	FITTING BODY A "T" EO M-F (DKOL) M-10L	RACCORD CORP EN "T" EO 28L M 36*2	T-ANSCHLUSSSTÜCK EO M-F (DKOL) M-10L	CUERPO EN "T" CODO EO M-F(DKOL)-M 10L
RD12	RD001200	NR	ADATTATORE "T" GAS M-FG-M 1/4 1/4 1/4	ADAPTOR	ADAPTATEUR	ADAPTER	ADAPTADOR
RG1	RG000100	NR	RACCORDO CORPO A GOMITO 10L MASCH.-FEMM. DKOL	ELBOW FITTING BODY 10L MASCH.-FEMM. DKOL	RACCORD CORPS À GENOUILLÈRE 10L MASCH.-FEMM. DKOL	WINKELSTÜCK	UNIÓN EN CODO 10L MACHO-HEMBRA DKOL
RG2	RG000200	NR	RACCORDO CORPO A GOMITO 12L MASCH.-FEMM. DKOL	ELBOW FITTING BODY 12L MASCH.-FEMM. DKOL	RACCORD COUDÉ 12L MÂLE-FEMELLE DKOL	ANSCHLUSS	CONEXION





POS	Codice	U.M.	 Descrizione	 Description	 Designation	 Benennung	 Descripción
RG3	RG000300	NR	RACCORDO CORPO A GOMITO 20S MASCHIO-FEMMINA DKOS	20S BODY FITTING ELBOW MALE-FEMALE DKOS	RACCORD À GENOUILLE 20S MÂLE-FEMELLE DKOS	WINKELSTÜCK 20S STIFT- BUCHSE DKOS	UNIÓN EN CODO 20S MACHO- HEMBRA DKOS
RG4	RG000400	NR	RACCORDO CORPO A GOMITO 28L MASCHIO-FEMMINA DKOL	28L BODY FITTING ELBOW MALE-FEMALE DKOL	RACCORD CORPS À GENOUILLE MÂLE-FEMELLE DKOL	WINKELSTÜCK 28L STIFT- BUCHSE DKOL	UNIÓN EN CODO 28L MACHO- HEMBRA DKOL
RG5	RG000500	NR	RACCORDO A L MASCHIO- FEMMINA 1/8	BODY 90 ° M / F 1/8 "			
RG6	RG000600	NR	ADATTATORE 90° BSPP M-FG 1/4	ADAPTOR	ADAPTATEUR	ADAPTER	ADAPTADOR
RN1	RN000100	NR	RACCORDO CORPO D'ESTREMITA' TENUTA ED 8L * 3/8 GAS *K*	END FITTING WITH SEAL ED 8L * 3/8 GAS * K *	RACCORD CORPS D'EXTRÉMITÉ AVEC JOINT ED 8L * 3/8 GAS *K*	ANSCHLUSSSTÜCK MIT DICHTUNG ED 8L * 3/8 GAS * K *	UNIÓN CON JUNTA ED 8L * 3/8 GAS *K*
RN2	RN000200	NR	RACCORDO CORPO D'ESTREMITA' TENUTA ED 12L * 3/8 GAS *K*	END FITTING WITH SEAL ED 12L * 3/8 GAS * K *	RACCORD CORPS D'EXTRÉMITÉ AVEC JOINT ED12L * 3/8 GAS *K*	ANSCHLUSSSTÜCK MIT DICHTUNG ED 12L * 3/8 GAS * K *	UNIÓN CON JUNTA ED 12L * 3/8 GAS *K*
RN3	RN000300	NR	RACCORDO CORPO D'ESTREMITA' TENUTA ED 10L * 3/8 GAS *K*	FITTING END OF BODY 'AND SEAL 10L * 3/8 GAS * K *	RACCORD D'EXTRÉMITÉ AVEC JOINT D'ÉTANCHÉITÉ 10L * 3/8 GAS *K*	ANSCHLUSS	CONEXION
RN4	RN000400	NR	RACCORDO CORPO D'ESTREMITA' TENUTA ED 8L * 1/4 GAS *K*	END FITTING WITH SEAL ED 8L * 1/4 GAS * K *	RACCORD CORPS D'EXTRÉMITÉ AVEC JOINT ED 8L * 1/4 GAS *K*	ANSCHLUSSSTÜCK MIT DICHTUNG ED 8L * 1/4 GAS * K *	UNIÓN CON JUNTA ED 8L * 1/4 GAS *K*
RN5	RN000500	NR	RACCORDO CORPO D'ESTREMITA' TENUTA ED 10L * 1/4 GAS *K*	FITTING END OF BODY 'AND SEAL 10L * 1/4 GAS * K *	RACCORD D'EXTRÉMITÉ AVEC JOINT D'ÉTANCHÉITÉ 10L * 1/4 GAS *K*	ANSCHLUSS	CONEXION
RN6	RN000600	NR	RACCORDO CORPO D'ESTREMITA' TENUTA ED 12L * 1/4 GAS	FITTING END OF BODY 'AND SEAL 12L * 1/4 GAS	RACCORD	ANSCHLUSS	CONEXION
RN7	RN000700	NR	RACCORDO NIPLES GAS CON.- GAS CON. 1/4" * 1/4"	FITTING	RACCORD	ANSCHLUSS	RACORD
RN8	RN000800	NR	RACCORDO CORPO D'ESTREMITA' TENUTA ED 15L * 1/2 GAS *K*	END FITTING WITH SEAL ED 15L * 1/2 * K * GAS	RACCORD CORPS D'EXTRÉMITÉ AVEC JOINT ED 15L * 1/2 GAS *K*	ANSCHLUSSSTÜCK MIT DICHTUNG ED 15L * 1/2 GAS *K*	UNIÓN CON JUNTA ED 15L * 1/2 GAS *K*



POS	Codice	U.M.	 Descrizione	 Description	 Designation	 Benennung	 Descripción
RN9	RN000900	NR	RACCORDO CORPO D'ESTREMITA' TENUTA ED 10L * 1/2 GAS *K*	FITTING END OF BODY 'AND SEAL 10L * 1/2 * K * GAS	RACCORD	ANSCHLUSS	CONEXION
RN10	RN001000	NR	RACCORDO CORPO D'ESTREMITA' TENUTA ED 15L * 3/4 GAS *K*	END FITTING WITH SEAL ED 15L * 3/4 GAS * K *	RACCORD CORPS D'EXTRÉMITÉ AVEC JOINT ED 15L * 3/4 GAS * K *	ANSCHLUSSSTÜCK MIT DICHTUNG ED 15L * 3/4 GAS *K*	UNIÓN CON JUNTA ED 15L * 3/4 GAS *K*
RN11	RN001100	NR	RACCORDO CORPO D'ESTREMITA' TENUTA ED 12L * 1/2 GAS *K*	END FITTING WITH SEAL ED 12L * 1/2 GAS * K *	RACCORD CORPS D'EXTRÉMITÉ AVEC JOINT ED 12L * 1/2 GAS *K*	ANSCHLUSSSTÜCK MIT DICHTUNG ED 12L * 1/2 GAS *K*	UNIÓN CON JUNTA ED 12L * 1/2 GAS *K*
RN12	RN001200	NR	RACCORDO CORPO D'ESTR. TENUTA ED 8L * 1/2 GAS	END FITTING WITH SEAL ED 8L * 1/2 GAS	RACCORD CORP D'EXTRÉMITÉ AVEC JOINT ED 8L * 1/2 GAS	ANSCHLUSSSTÜCK MIT DICHTUNG ED 8L * 1/2 GAS	UNIÓN CON JUNTA ED 8L * 1/2 GAS
RN13	RN001300	NR	RACCORDO CORPO D'ESTR. TENUTA ED 8L * 3/4 GAS	CONNECTOR BODY OF EXTR. SEAL AND 8L * 3/4 GAS	RACCORD	ANSCHLUSS	CONEXION
RN14	RN001400	NR	RACCORDO CORPO D'ESTR. TENUTA ED 12L * 3/4 GAS	CONNECTOR BODY OF EXTR. SEAL AND 12L * 3/4 GAS	RACCORD	ANSCHLUSS	CONEXION
RN15	RN001500	NR	RACCORDO CORPO D'ESTR.TENUTA ED 15L * 3/8 GAS	END FITTING WITH SEAL ED 15L * 3/8 GAS	RACCORD CORPS D'EXTRÉMITÉ AVEC JOINT ED 15L * 3/8 GAS	ANSCHLUSSSTÜCK MIT DICHTUNG ED 15L * 3/8 GAS	UNIÓN CON JUNTA ED 15L * 3/8 GAS
RN16	RN001600	NR	RACCORDO CORPO D'ESTR.TENUTA ED 22L * 3/4 GAS	END FITTING WITH SEAL ED 22L * 3/4 GAS	RACCORD CORP D'EXTRÉMITÉ AVEC JOINT ED 22L * 3/4 GAS	ANSCHLUSSSTÜCK MIT DICHTUNG ED 22L * 3/4 GAS	UNIÓN CON JUNTA ED 22L * 3/4 GAS
RN17	RN001700	NR	RACCORDO CORPO D'ESTR. TENUTA ED 28L * 3/4" GAS	END FITTING WITH SEAL ED 28L * 3/4 BSP	RACCORD CORPS D'EXTRÉMITÉ AVEC JOINT ED 28L * 3/4 BSP	ANSCHLUSSSTÜCK MIT DICHTUNG ED 28L * 3/4" GAS	UNIÓN CON JUNTA ED 28L * 3/4" GAS
RN18	RN001800	NR	RACCORDO CORPO D'ESTR. TENUTA ED 20S * 3/4 GAS	CONNECTOR BODY OF EXTR. SEAL AND 20S * 3/4 GAS	RACCORD	ANSCHLUSS	CONEXION
RN19	RN001900	NR	RACCORDO CORPO D'ESTREMITA' 8L * M 12X1.5 ED	END FITTING 8L * M 12X1.5 ED	RACCORD CORPS D'EXTRÉMITÉ 8L * M 12X1.5 ED	ANSCHLUSSSTÜCK 8L * M 12X1.5 ED	UNIÓN 8L * M 12X1.5 ED
RN20	RN002000	NR	RACCORDO CORPO D'ESTREMITA' 8L * M 14X1.5 ED	FITTING END OF BODY 'AND 8L * M 14X1.5	RACCORD	ANSCHLUSS	CONEXION



POS	Codice	U.M.	 Descrizione	 Description	 Designation	 Benennung	 Descripción
RN21	RN002100	NR	RACCORDO CORPO D'ESTREMITA' 10L * M 18X1.5 ED	END FITTING 10L * M 18X1.5	RACCORD CORPS D'EXTRÉMITÉ 10L * M 18X1.5 ED	ANSCHLUSSSTÜCK 10L * M 18X1.5 ED	UNIÓN 10L * M 18X1.5 ED
RN22	RN002200	NR	RACCORDO CORPO D'ESTR. TENUTA ED 15L * M 18X1.5	CONNECTOR BODY OF EXTR. SEAL AND 15L * M 18X1.5	RACCORD	ANSCHLUSS	CONEXION
RN23	RN002300	NR	RACCORDO CORPO D'ESTR. TENUTA ED 15L * M 22X1.5	END FITTING WITH SEAL ED 15L * M 22X1.5	RACCORD CORPS D'EXTRÉMITÉ AVEC JOINT ED 15L * M 22X1.5	ANSCHLUSSSTÜCK MIT DICHTUNG ED 15L * M 22X1.5	UNIÓN CON JUNTA ED 15L * M 22X1.5
RN24	RN002400	NR	RACCORDO CORPO D'ESTR. TENUTA ED 22L * M26X1.5	CONNECTOR BODY OF EXTR. SEAL AND 22L * M26X1.5	RACCORD	ANSCHLUSS	CONEXION
RN25	RN002500	NR	RACCORDO CORPO D'ESTR. TENUTA ED 20S * M27X2	CONNECTOR BODY OF EXTR. SEAL AND 20S * M27X2	RACCORD	ANSCHLUSS	CONEXION
RN26	RN002600	NR	RACCORDO CORPO D'ESTR. 8L * 9/16-18 UNF-2A	END FITTING 8L * 9/16-18 UNF-2A	RACCORD CORPS D'EXTRÉMITÉ 8L * 9/16-18 UNF-2A	ANSCHLUSSSTÜCK 8L * 9/16-18 UNF-2A	UNIÓN 8L * 9/16-18 UNF-2A
RN27	RN002700	NR	RACCORDO CORPO D'ESTR. 12L * 3/4 -16 UNF-2A	END FITTING 12L * 3/4 -16 UNF-2A	RACCORD CORPS D'EXTRÉMITÉ 12L * 3/4 -16 UNF-2A	ANSCHLUSSSTÜCK 12L * 3/4 -16 UNF-2A	UNIÓN 12L * 3/4 -16 UNF-2A
RN28	RN002800	NR	RACCORDO CORPO D'ESTR. 20S * 1.5/16 -12 UN-2A	END FITTING 20S * 1.5/16 -12 UN-2A	RACCORD CORPS D'EXTRÉMITÉ 20S * 1.5/16 -12 UN-2A	ANSCHLUSSSTÜCK 20S * 1.5/16 -12 UN-2A	UNIÓN 20S * 1.5/16 -12 UN-2A
RN29	RN002900	NR	RACCORDO CORPO D'ESTR. TENUTA ED 22L * M26X1.5	END FITTING WITH SEAL ED 22L * M26X1.5	RACCORD CORPS D'EXTRÉMITÉ AVEC JOINT ED 22L * M26X1.5	ANSCHLUSSSTÜCK MIT DICHTUNG ED 22L * M26X1.5	UNIÓN CON JUNTA 22L * M26X1.5
RN30	RN003000	NR	RACCORDO CORPO D'ESTR. TENUTA ED 22L * M26X1.5	END FITTING WITH SEAL ED 22L * M26X1.5	RACCORD CORPS D'EXTRÉMITÉ AVEC JOINT ED 22L * M26X1.5	ANSCHLUSSSTÜCK MIT DICHTUNG ED 22L * M26X1.5	UNIÓN CON JUNTA ED 22L * M26X1.5
RN31	RN003100	NR	RACCORDO CORPO D'ESTREMITA' TENUTA ED 6L * 1/4 GAS *K*	END FITTING WITH SEAL 1/4 BSPP 6L	RACCORD CORPS D'EXTRÉMITÉ AVEC JOINT 1/4 BSPP 6L	ANSCHLUSSSTÜCK MIT DICHTUNG 1/4 BSPP 6L	UNIÓN CON JUNTA 1/4 BSPP 6L
RN32	RN003200	NR	RACCORDO CORPO D'ESTREMITA' TENUTA ED 8L * 3/8 GAS *K*	END FITTING WITH SEAL ED 8L * 3/8 GAS * K *	RACCORD CORPS D'EXTRÉMITÉ AVEC JOINT ED 8L * 3/8 GAS *K*	ANSCHLUSSSTÜCK MIT DICHTUNG ED 8L * 3/8 GAS * K *	UNIÓN CON JUNTA ED 8L * 3/8 GAS *K*

POS	Codice	U.M.	 Descrizione	 Description	 Designation	 Benennung	 Descripción
RN33	RN003300	NR	NIPPLES 1/8" JIS 1/8"GAS	CAP	CAPUCHON	NIPPEL	CAPUCHO
RN34	RN003400	NR	NIPPLES 1/4" JIS 1/4"GAS	CAP	CAPUCHON	NIPPEL	CAPUCHO
RN35	RN003500	NR	NIPPLES 3/8" JIS 1/4"GAS	CAP	CAPUCHON	NIPPEL	CAPUCHO
RN36	RN003600	NR	NIPPLES 3/8" JIS 1/4"GAS	CAP	CAPUCHON	NIPPEL	CAPUCHO
RO1	RO000100	NR	OGIVA PER TUBO Ø=12	OGIVE FOR TUBE Ø = 12	OGIVE POUR TUYAU Ø = 12	OGIVE FÜR ROHR Ø = 12	OJIVA PARA TUBO Ø=12
RR1	RR000100	NR	RONDELLA RAME 1/4	COPPER WASHER 1/4	RONDELLE	SCHEIBE	ARANDELA
RR2	RR000200	NR	RONDELLA BONDED GAS 3/8" *K*	BONDED WASHER GAS 3/8 " * K *	RONDELLE	SCHEIBE	ARANDELA
RR3	RR000300	NR	RONDELLA BONDED METRICA 12 *K*	METRIC BONDED WASHER 12 * K *	RONDELLE BONDED MÉTRIQUE 12 *K*	BONDED UNTERLEGSCHIEBE 12 * K *	ARANDELA BONDED MÉTRICA 12 *K*
RR4	RR000400	NR	RONDELLA BONDED GAS 1/4" *K*	BONDED WASHER GAS 1/4 " * K *	RONDELLE		
RR5	RR000500	NR	RONDELLA BONDED GAS 1/2" *K*	BONDED WASHER GAS 1/2 " * K *	RONDELLE BONDED GAS 1/2" *K*	BONDED UNTERLEGSCHIEBE GAS 1/2" *K*	ARANDELA BONDED GAS 1/2" *K*
RR6	RR000600	NR	RONDELLA RAME 3/8	COPPER WASHER 3/8	RONDELLE	SCHEIBE	ARANDELA
RR7	RR000700	NR	RONDELLA BONDED GAS 1/8" *K*	BONDED WASHER GAS 1/8 " * K *	RONDELLE	SCHEIBE	ARANDELA
RR8	RR000800	NR	RONDELLA BONDED GAS 1" *K*	BONDED WASHER GAS 1 " * K *	RONDELLE BONDED GAS 1" *K*	BONDED UNTERLEGSCHIEBE GAS 1" *K*	ARANDELA BONDED GAS 1" *K*
RR9	RR000900	NR	RONDELLA BONDED GAS 3/4" *K*	BONDED WASHER GAS 3/4 " * K *	RONDELLE BONDED GAS 3/4" *K*	BONDED UNTERLEGSCHIEBE GAS 3/4" *K*	ARANDELA BONDED GAS 3/4" *K*
RR10	RR001000	NR	RONDELLA BONDED GAS 1.1/4"	BONDED WASHER GAS 1.1 / 4 "	RONDELLE	SCHEIBE	ARANDELA
RR11	RR001100	NR	RONDELLA RAME M10	COPPER WASHER M10	RONDELLE	SCHEIBE	ARANDELA
RR12	RR001200	NR	RONDELLA RAME 1/2	COPPER WASHER 1/2	RONDELLE	SCHEIBE	ARANDELA
RR13	RR001300	NR	RONDELLA BONDED M12	BONDED WASHER M12	RONDELLE	SCHEIBE	ARANDELA
RS1	RS000100	NR	COPPIA SEMIFLANGE SAE 6000 3/4"	PAIR 6000 SAE FLANGE HALVES 3/4 "	COUPLE SEMI-BRIDES SAE 6000 3/4"	SAE-HALBFLANSCHEN PAAR 6000 3/4"	PAREJA SEMIBRIDAS SAE 6000 3/4"



POS	Codice	U.M.	 Descrizione	 Description	 Designation	 Benennung	 Descripción
RS2	RS000200	NR	RACC.M 20S(M30X2) - ED M 1"5/16 UNF H=33	FITTING M 20S (M30X2) - ED M 1 "5/16 UNF H = 33	RACCORD M 20S(M30X2) - ED M 1"5/16 UNF H=33	ANSCHLUSSSTÜCK M 20S (M30X2) - ED M 1 "5/16 UNF H = 33	UNIÓN M 20S(M30X2) - ED M 1"5/16 UNF H=33
RS3	RS000300	NR	RIDUZIONE M-F GAS 1" * 1/2"	REDUCING GAS M-F 1 " * 1/2"	RÉDUCTION M-F GAS 1" * 1/2"	REDUKTION M-F GAS 1" * 1/2"	REDUCCIÓN M-F GAS 1" * 1/2"
RS4	RS000400	NR	RACCORDO COLONNETTA M15L - 3/8" GAS H=50	COLUMN CONNECTION M15L - 3/8 "GAS H = 50	RACCORD DOIGT M15L - 3/8 "GAS H = 50	ANSCHLUSS M15L - 3/8 "GAS H = 50	CODO M15L - 3/8" GAS H=50
RS5	RS000500	NR	RACCORDO COLONNETTA M15L - 3/8" GAS H=96	COLUMN CONNECTION M15L - 3/8 "GAS H = 96	RACCORD DOIGT M15L - 3/8" GAS H=96	ANSCHLUSS - 3/8 "GAS H = 96	CODO M15L - 3/8" GAS H=96
RS6	RS000600	NR	CODOLO M1/4" ED X FG 8L (M14X1.5)	FITTING M1 / 4 "X AND FG 8L (M14X1.5)	EMBOUT M1/4" ED X FG 8L (M14X1.5)	SCHAFT M1/4" ED X FG 8L (M14X1.5)	CODO M1/4" ED X FG 8L (M14X1.5)
RS7	RS000700	NR	RIDUZIONE M-F GAS 1" * 1/2"	REDUCING GAS M-F 1 " * 1/2"	RÉDUCTION M-F GAS 1" * 1/2"	REDUZIERUNG GAS M-F 1" * 1/2"	REDUCCIÓN M-F GAS 1" * 1/2"
RS8	RS000800	NR	RACCORDO CODOLO D' ESTR. FEM. DKO 12L*3/8 GAS ED	END FITTING FEM. DKO 12L*3/8 GAS ED	RACCORD FEM. DKO 12L*3/8 GAS ED	ANSCHLUSS FEM. DKO 12L*3/8 GAS ED	CONECTOR FEM. DKO 12L*3/8 GAS ED
RS9	RS000900	NR	MANICOTTO ARIA 1/8-1/8	AIR MANIFOLD 1/8-1/8			
RS10	RS001000	NR	RIDUZIONE M-F GAS 3/8" JIS 1/8" BSPP	REDUCING GAS M-F 3/8" JIS 1/8" BSPP	RÉDUCTION M-F GAS 3/8" JIS 1/8" BSPP	REDUZIERUNG GAS M-F 3/8" JIS 1/8" BSPP	REDUCCIÓN M-F GAS 3/8" JIS 1/8" BSPP
RS11	RS001100	NR	RACCORDO M-M 15L	FITTING M-M 15L			
RS12	RS001200	NR	RACCORDO NIPLES GAS CON.- GAS CON.1/2"1/2"	FITTING 1/2" - 1/2"	RACCORD	ANSCHLUSS	RACORD
RT1	RT000100	NR	TAPPO MASCHIO TE GAS 3/8" SVASATO 60° *K*	SCREW EYE FOR GAS 1/2 "H = 50	BOUCHON	VERSCHLUSS	TAPA
RT2	RT000200	NR	TAPPO MASCHIO ESAGONO INTERNO GAS 1/4" SVASATO 60° *K*	MALE PLUG GAS INTERNAL HEX 1/4 "FLARE 60 ° * K *	BOUCHON MÂLE HEXAGONAL INTÉRIEUR GAS 1/4" ÉVASÉ 60° *K*	ZYLINDRISCHER STOPFEN	TAPÓN MACHO HEXÁGONO INTERNO GAS 1/4" SVASATO 60° *K*
RT3	RT000300	NR	TAPPO MASCHIO TE GAS 1/2" SVASATO 60° *K*	MALE PLUG TE GAS 1/2 "FLARE 60 ° * K *	BOUCHON MÂLE TE GAS 1/2" ÉVASÉ 60° *K*	STECKER TE GAS 1/2 "GESENKT 60 ° * K *	TAPÓN MACHO TE GAS 1/2" ABOCINADO 60° *K*
RT4	RT000400	NR	TAPPO MASCHIO TE GAS 1/4" SVASATO 60° *K*	MALE PLUG TE GAS 1/4 "FLARE 60 ° * K *	BOUCHON	VERSCHLUSS	TAPA
RT5	RT000500	NR	TAPPO MASCHIO ESAGONO INTERNO GAS 3/8" SVASATO 60° *K*	MALE PLUG GAS INTERNAL HEX 3/8 "FLARE 60 ° * K *	BOUCHON	VERSCHLUSS	TAPA



POS	Codice	U.M.	 Descrizione	 Description	 Designation	 Benennung	 Descripción
RT6	RT000600	NR	TAPPO MASCHIO ESAGONO INTERNO GAS 1" SVASATO 60° *K*	MALE PLUG GAS INTERNAL HEX 1 "FLARE 60 ° * K *	BOUCHON MÂLE HEXAGONAL INTÉRIEUR GAS 1" ÉVASÉ 60° *K*	ZYLINDRISCHER STOPFEN + DICHTUNG	TAPÓN MACHO HEXÁGONO INTERNO GAS 1" ABOCINADO 60° *K*
RT7	RT000700	NR	TAPPO MASCHIO TE GAS 1/8" SVASATO 60° *K*	MALE PLUG TE GAS 1/8 "FLARE 60 ° * K *	BOUCHON	VERSCHLUSS	TAPA
RT8	RT000800	NR	TAPPO MASCHIO TE GAS 1/4" JIS	MALE PLUG TE GAS 1/4 " JIS	BOUCHON	VERSCHLUSS	TAPA
RT9	RT000900	NR	TAPPOO FEMMINA COMPLETO 6L	COMPLETE 6L FEMALE CAP			
RT10	RT001000	NR	TAPPOO FEMMINA COMPLETO 8L	COMPLETE 8L FEMALE CAP	COUVERCLE	DECKEL	TAPA
RT11	RT001100	NR	TAPPO CILINDRICO TCEI+GUARNIZIONE GAS CI 5.8 3/4 Z.BIANCA	CYLINDRICAL SOCKET HEAD CAP + SEAL GAS CI 5.8 3/4 Z. WHITE	BOUCHON	VERSCHLUSS	TAPA
RT12	RT001200	NR	TAPPO CILINDRICO TCEI+GUARNIZIONE GAS CI 5.8 1/2 Z.BIANCA	CYLINDRICAL SOCKET HEAD CAP + SEAL GAS CI 5.8 1/2 Z. WHITE	BOUCHON	VERSCHLUSS	TAPA
RV1	RV000100	NR	VITE PER OCCHIO GAS 1/4" H=29 *K*	SCREW EYE FOR GAS 1/4 "H = 29 * K *	VIS	SCHRAUBE	TORNILLO
RV2	RV000200	NR	VITE PER OCCHIO DOPPIA GAS 3/8"	SCREW EYE DOUBLE FOR GAS 3/8 "	VIS	SCHRAUBE	TORNILLO
RV3	RV000300	NR	VITE PER OCCHIO GAS 1/2" H=50	SCREW EYE FOR GAS 1/2 "H = 50	VIS	SCHRAUBE	TORNILLO
RV4	RV000400	NR	VITE PER OCCHIO DOPPIA GAS 1/4"	DOUBLE EYE SCREW FOR GAS 1/4"	VIS DOUBLE À OEIL GAS 1/4"	DOPPEL-AUGENSCHRAUBE GAS 1/4"	TORNILLO DOBLE OJO GAS 1/4"
RV5	RV000500	NR	VITE PER OCCHIO GAS 3/8"	SCREW EYE FOR GAS 3/8"	VIS	SCHRAUBE	TORNILLO
RV6	RV000600	NR	VITE PER OCCHIO GAS 1/8"	SCREW EYE FOR GAS 1/8"	VIS	SCHRAUBE	TORNILLO

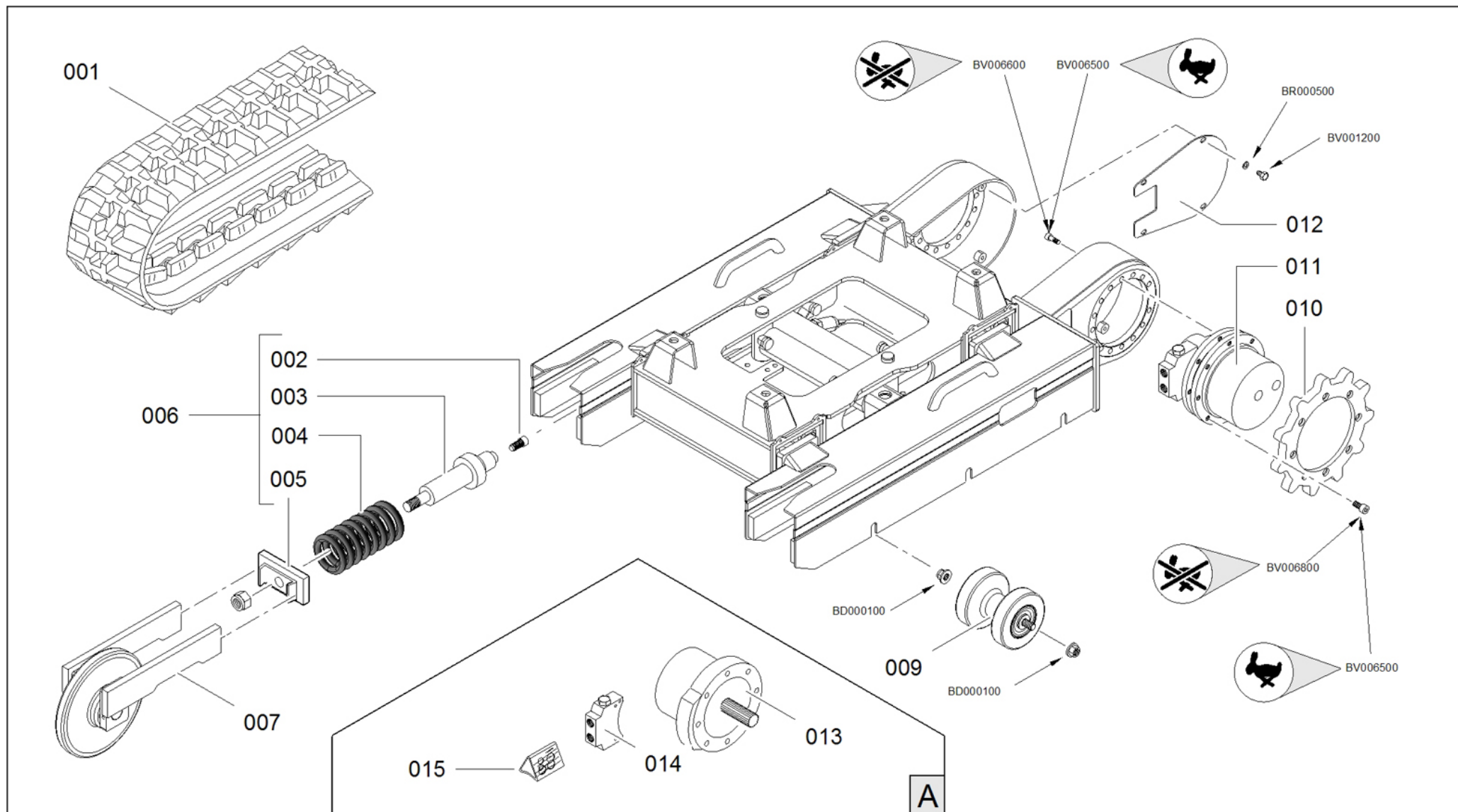

 SOTTOCARRO CINGOLATO
 TRACKED UNDERCARRIAGE
 CHENILLARD





 RAUPENFAHRWERK
 CARRO DE ORUGAS









Main color codes:  J1 - JLG Cream,  J2 - JLG Orange,  C4 - Green



 SOTTOCARRO CINGOLATO
 TRACKED UNDERCARRIAGE
 CHENILLARD





 RAUPENFAHRWERK
 CARRO DE ORUGAS



POS	Codice	 Descrizione	 Description	 Designation	 Benennung	 Descripción
1	053715L0	CINGOLO IN GOMMA BASSO PROFILO NERO	RUBBER TRACK LOW PROFILE BLACK	CHENILLE EN CAOUTCHOUC	GUMMIRAUPE	ORUGA DE GOMA
1	053715LB	CINGOLO IN GOMMA BASSO PROFILO ANTITRACCIA	RUBBER TRACK LOW PROFILE NO MARKING	CHENILLE BLANCHE CAOUTCHOUC	GUMMIRAUPE	ORUGA BLANCA DE GOMA
2	03149200	VALVOLA IDRAULICA	HYDRAULIC VALVE	VALVE HYDRAULIQUE	HYDRAULIKVENTIL	VÁLVULA HIDRÁULICA
3	10681670	CILINDRO	CYLINDER	VÉRIN	ZYLINDER	CILINDRO
4	03024800	MOLLA	SPRING	RESSORT	FEDER	MUELLE
5	34719500	PIATTO	PLATE	PLATEAU	PLATTE	PLACA
6	147534Y1	SUPPORTO TENDICINGOLO	IDLER SUPPORT	SUPPORT TENDEUR CHENILLE	KETTEHSPANNER-HALTER	SOPORTE TENSOR ORUGA
7	153937A3	RUOTA TENDICINGOLO	IDLER WHEEL	ROUE TENDEUR DE CHENILLE	RAUPENSPANNRAD	RUEDA TENSOR ORUGA
7	153937H2	RUOTA TENDICINGOLO	IDLER WHEEL	ROUE TENDEUR DE CHENILLE	RAUPENSPANNRAD	RUEDA TENSOR ORUGA
9	153515A3	RULLO INFERIORE	CARRIER ROLLER	ROULEAU INFÉRIEUR	UNTERE ROLLER	RODILLO INFERIOR
9	153515H2	RULLO INFERIORE	CARRIER ROLLER	ROULEAU INFÉRIEUR	UNTERE ROLLE	RODILLO INFERIOR
10	041736A3	RUOTA DI TRAZIONE	SPROCKET WHEEL	ROUE DE TRACTION	ANTRIEBSRAD	RUEDA DE ARRASTRE
10	041736H2	RUOTA DI TRAZIONE	SPROCKET WHEEL	ROUE DE TRACTION	ANTRIEBSRAD	RUEDA DE ARRASTRE
10	055707A3	RUOTA DI TRAZIONE	SPROCKET WHEEL	ROUE DE TRACTION	ANTRIEBSRAD	RUEDA DE ARRASTRE
10	055707H2	RUOTA DI TRAZIONE	SPROCKET WHEEL	ROUE DE TRACTION	ANTRIEBSRAD	RUEDA DE ARRASTRE
11	147411A3	MOTORIDUTTORE	GEAR MOTOR	MOTORÉDUCTEUR	GETRIEBEMOTOR	MOTORREDUCTOR
11	147411H2	MOTORIDUTTORE	MOTORGearBOX	MOTORÉDUCTEUR	GETRIEBEMOTOR	MOTORREDUCTOR
11	267525A3	MOTORIDUTTORE 700C2K I:32 + MAG12 VP AUTO2SPEED CON FRENO	GEAR MOTOR 700C2K I: 32 + MAG12 VP AUTO2SPEED WITH BRAKE	MOTORÉDUCTEUR	GETRIEBEMOTOR	MOTORREDUCTOR
11	267525H2	MOTORIDUTTORE 700C2K I:32 + MAG12 VP AUTO2SPEED CON FRENO	GEAR MOTOR 700C2K I: 32 + MAG12 VP AUTO2SPEED WITH BRAKE	MOTORÉDUCTEUR	GETRIEBEMOTOR	MOTORREDUCTOR
12	053809A3	COPERCHIO	COVER	COUVERCLE	DECKEL	TAPA



Main color codes:  J1 - JLG Cream,  J2 - JLG Orange,  C4 - Green

 SOTTOCARRO CINGOLATO
 TRACKED UNDERCARRIAGE
 CHENILLARD



RAUPENFAHRWERK 
 CARRO DE ORUGAS 

POS	Codice	 Descrizione	 Description	 Designation	 Benennung	 Descripción
12	053809H2	COPERCHIO	COVER	COUVERCLE	DECKEL	TAPA
12	054868A3	COPERCHIO 2 VELOCITÀ	COVER HIGH SPEED	COUVERCLE	TAPA	DEKSEL
12	054868H2	COPERCHIO 2 VELOCITÀ	COVER HIGH SPEED	COUVERCLE	TAPA	DEKSEL
13	1474110002	MOTORE IDRAULICO	HYDRAULIC MOTOR	MOTEUR HYDRAULIQUE	HYDRAULIKMOTOR	MOTOR HIDRÁULICO
14	1450590003	VALVOLA IDRAULICA	HYDRAULIC VALVE	VALVE HYDRAULIQUE	VALVE HYDRAULIQUE	VÁLVULA HIDRÁULICA
15	1450590004	KIT GUARNIZIONI COMPLETO PER 145059NV-147411NV-15041600	SEALS COMPLETE KIT 145059 147411 NV-NV-15041600	KIT JOINTS	DICHTUNGSSATZ	KIT JUNTAS

-  ALLARGAMENTO IDRAULICO
-  HYDRAULIC EXTENSION
-  ECARTEMENT HYDRAULIQUE

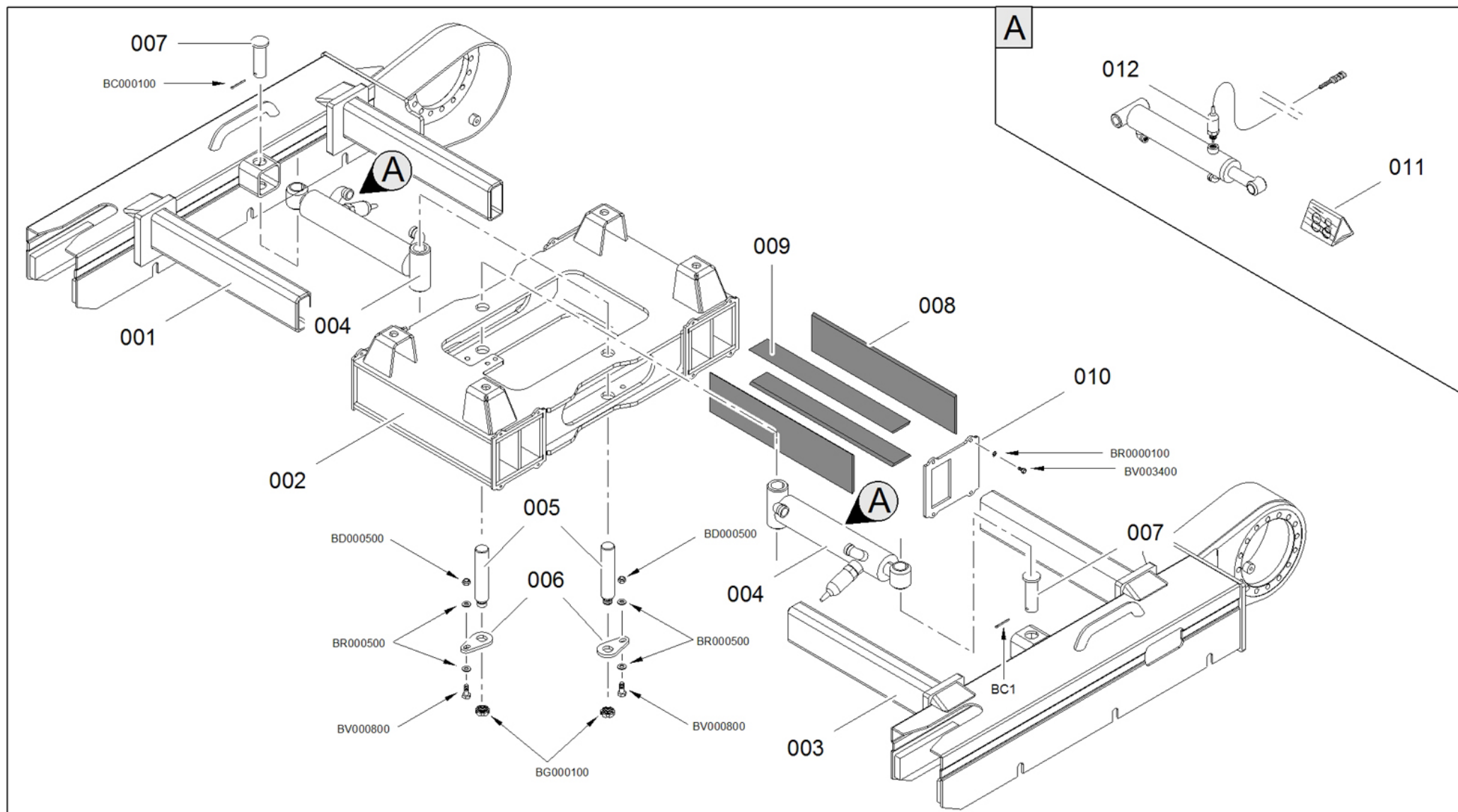
HYDR. SPURWEITENVER STELLEINRICHTUNG 
 EXTENSION HIDRAULICA 







Main color codes:  **J1** - JLG Cream,  **J2** - JLG Orange,  **C4** - Green

 ALLARGAMENTO IDRAULICO

 HYDRAULIC EXTENSION

 ECARTEMENT HYDRAULIQUE
HYDR. SPURWEITENVER STELLEINRICHTUNG EXTENSION HIDRAULICA 



POS	Codice	 Descrizione	 Description	 Designation	 Benennung	 Descripción
1	377583A3	LONGHERONE DESTRO SOTTOCARRO ALLARGABILE LL1570 AUTO2SPEED	RIGHT EXTENDABLE UNDERCARRIAGE LL1570 AUTO2SPEED	PARTIE DROITE CHENILLARD	FAHRWERK RECHTE SEITE	PARTE DERECHA DEL CARRO
1	377583H2	LONGHERONE DESTRO SOTTOCARRO ALLARGABILE LL1570 AUTO2SPEED	RIGHT EXTENDABLE UNDERCARRIAGE LL1570 AUTO2SPEED	PARTIE DROITE CHENILLARD	FAHRWERK RECHTE SEITE	PARTE DERECHA DEL CARRO
1	378038A3	LONGHERONE DESTRO SOTTOCARRO ALLARGABILE LL1570 SINGOLA VELOCITA' HINOWA GREY	LONGHERONE RIGHT EXTENDABLE UNDERCARRIAGE LL1570 SINGLE SPEED 'HINOWA GREY	TRAIN DE CHENILLE DROITE	RECHTER FAHRSCHIFF	PARTE CARRO DERECHO
1	378038H2	LONGHERONE DESTRO SOTTOCARRO ALLARGABILE LL1570 SINGOLA VELOCITA' HINOWA GREY	LONGHERONE RIGHT EXTENDABLE UNDERCARRIAGE LL1570 SINGLE SPEED 'HINOWA GREY	TRAIN DE CHENILLE DROITE	RECHTER FAHRSCHIFF	PARTE CARRO DERECHO
2	377559A3	STRUTTURA CENTRALE SOTTOCARRO LL1570 SALDATA	CENTRAL STRUCTURE UNDERCARRIAGE LL1570 WELDED	ESTRUCTURE CENTRALE	MITTELBAU	ESTRUCTURA CENTRAL
2	377559H2	STRUTTURA CENTRALE SOTTOCARRO LL1570 SALDATA	CENTRAL STRUCTURE UNDERCARRIAGE LL1570 WELDED	ESTRUCTURE CENTRALE	MITTELBAU	ESTRUCTURA CENTRAL

 ALLARGAMENTO IDRAULICO

 HYDRAULIC EXTENSION

 ECARTEMENT HYDRAULIQUE
HYDR. SPURWEITENVER STELLEINRICHTUNG EXTENSION HIDRAULICA 





POS	Codice	 Descrizione	 Description	 Designation	 Benennung	 Descripción
3	377584A3	LONGHERONE SINISTRO SOTTOCARRO ALLARGABILE LL1570 AUTO2SPEED	LEFT EXTENDABLE UNDERCARRIAGE LL1570 AUTO2SPEED	PARTIE GAUCHE CHENILLARD	FAHRWERK LINKER SEITE	PARTE IZQUIERDA DEL CARRO
3	377584H2	LONGHERONE SINISTRO SOTTOCARRO ALLARGABILE LL1570 AUTO2SPEED	LEFT EXTENDABLE UNDERCARRIAGE LL1570 AUTO2SPEED	PARTIE GAUCHE CHENILLARD	FAHRWERK LINKER SEITE	PARTE IZQUIERDA DEL CARRO
3	378039A3	LONGHERONE DESTRO SOTTOCARRO ALLARGABILE LL1570 SINGOLA VELOCITA' HINOWA GREY	LONGHERONE RIGHT EXTENDABLE UNDERCARRIAGE LL1570 SINGLE SPEED 'HINOWA GREY	TRAIN DE CHENILLE DROIT	RECHTER FAHRSCHIFF	PARTE CARRO DERECHO
3	378039H2	LONGHERONE DESTRO SOTTOCARRO ALLARGABILE LL1570 SINGOLA VELOCITA' HINOWA GREY	LONGHERONE RIGHT EXTENDABLE UNDERCARRIAGE LL1570 SINGLE SPEED 'HINOWA GREY	TRAIN DE CHENILLE DROIT	RECHTER FAHRSCHIFF	PARTE CARRO DERECHO
4	277103A3	CILINDRO ALLARGAMENTO CARRO LL1570-X15JP- X430AJ	CYLINDER ENLARGEMENT CARRIAGE LL1570- X15JP-X430AJ	CYLINDRE ÉLARGISSEMENT	SPURVERBREITERUN GSZYLINDER	CILINDRO ENSANCHAMIENTO
4	277103H2	CILINDRO ALLARGAMENTO CARRO LL1570-X15JP- X430AJ	CYLINDER ENLARGEMENT CARRIAGE LL1570- X15JP-X430AJ	CYLINDRE ÉLARGISSEMENT	SPURVERBREITERUN GSZYLINDER	CILINDRO ENSANCHAMIENTO
5	06023800	SPINA FONDELLO ALLARGAMENTO	BOTTOM PLUG ENLARGEMENT	BAS PLUG ELARGISSEMENT	UNTEN PLUG ERWEITERUNG	BASE ENCHUFE AMPLIACIÓN
6	064965Y1	GOCCIA SPINA	PIN DROP	BAISSE CHEVILLE	TROPFEN	CAÍDA CLAVIJA
7	04256300	SPINA	PIN	CHEVILLE	STIFT	CLAVIJA



Main color codes:  J1 - JLG Cream,  J2 - JLG Orange,  C4 - Green



 ALLARGAMENTO IDRAULICO

 HYDRAULIC EXTENSION



 ECARTEMENT HYDRAULIQUE
HYDR. SPURWEITENVER STELLEINRICHTUNG EXTENSION HIDRAULICA 

POS	Codice	 Descrizione	 Description	 Designation	 Benennung	 Descripción
8	07758900	GUIDA ALLARGAMENTO LL1570-X15JP-X430AJ 88X4.2X374	ENLARGEMENT GUIDE LL1570-X15JP- X430AJ 88X4.2X374	GUIDE	FÜHRUNG	GUÍA
9	07758800	GUIDA ALLARGAMENTO LL1570 48X4.2X374	GUIDE	GUIDE	FÜHRUNG	GUÍA
10	377580A3	COPERCHIO FERMO GUIDE ALLARGAMENTO LL1570	COVER GUIDE ENLARGEMENT LL1570	COUVERCLE	ABDECKUNG	TAPA
10	377580H2	COPERCHIO FERMO GUIDE ALLARGAMENTO LL1570	COVER GUIDE ENLARGEMENT LL1570	COUVERCLE	ABDECKUNG	TAPA
11	2771030001	KIT GUARNIZIONE CILINDRO ALLARGAMENTO CARRO LL1570 X15JP X430AJ	CYLINDER SEAL KIT CARRIAGE ENLARGEMENT LL1570 X15JP X430AJ	KIT JOINT	DICHTUNGSSATZ	KIT JUNTAS
12	17329500	MICROINTERRUPTOR E ALLARGAMENTO CARRO N/O COMPLETO DI CAVO E CONNETTORE	WIDENING SYSTEM MICRO SWITCH N/O CONTACT WITH CABLE AND CONNECTOR	MICRO INTERRUPTEUR ELARGISSEMENT AVEC CABLE ET CONNECTEUR	MIKROSCHALTER SPURVERBREITERUN G MIT KABEL UND STECKER	MICROINTERRUPTOR ENSANCHAMIENTO CON CABLE Y CONECTOR

-  BASE TORRETTA
-  TURRET BASE
-  BASE TOURELLE

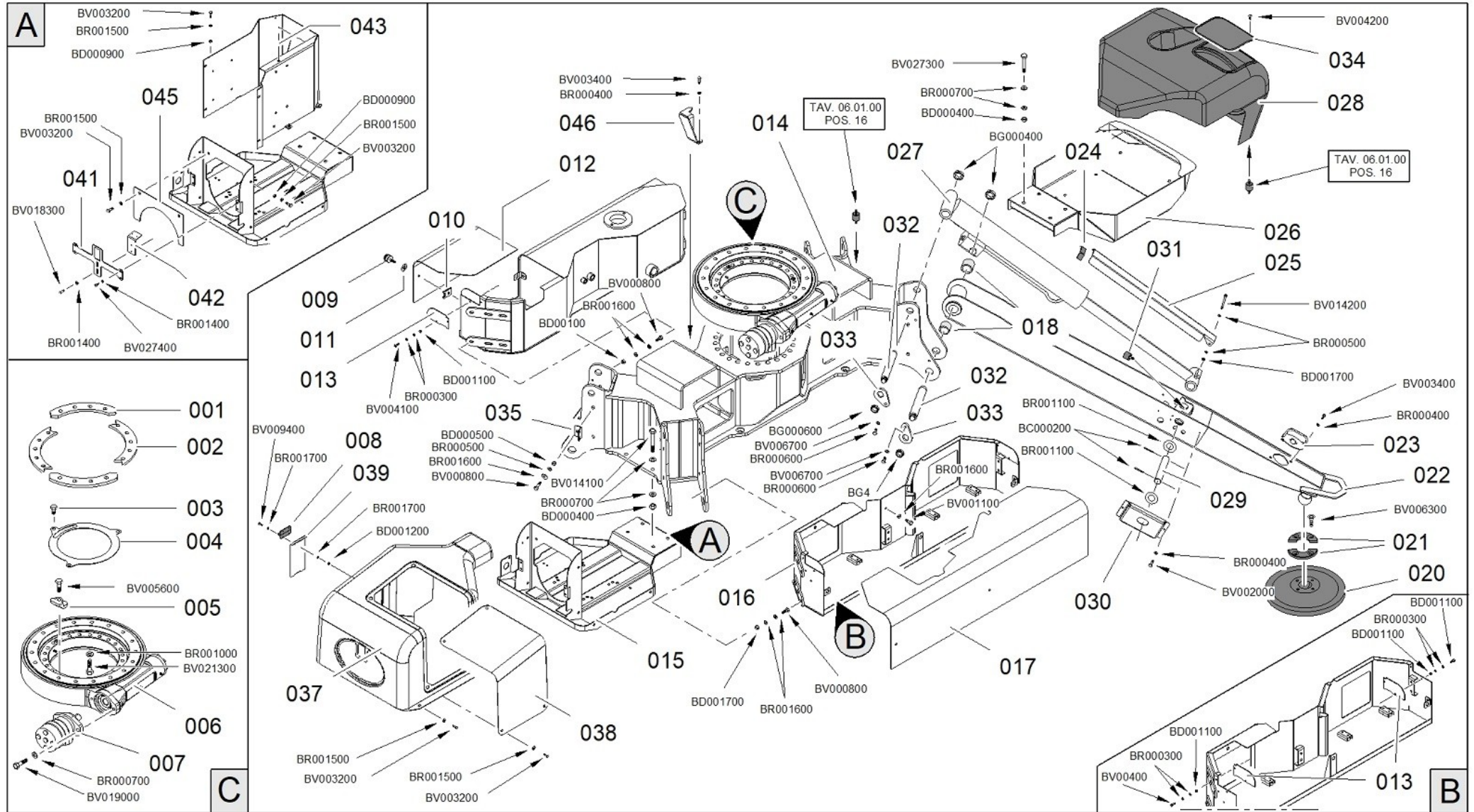
ARBEITSTURM 
 BASE TORRETTA GIRATORIA 











Main color codes:  J1 - JLG Cream,  J2 - JLG Orange,  C4 - Green

 BASE TORRETTA

 TURRET BASE

 BASE TOURELLE
ARBEITSTURM BASE TORRETTA GIRATORIA 





POS	Codice	 Descrizione	 Description	 Designation	 Benennung	 Descripción
1	069349Y1	SPESSORE	THICKNESS	CALE	STÄRKE	ESPEJOR
2	069348Y1	SPESSORE	THICKNESS	CALE	STÄRKE	ESPEJOR
4	077710Y1	RISCONTRO	FASTENER LOCATOR	PLAQUE POUR AGRAFAGE	ANSCHLAG	GANCHO
5	068911Y1	FERMO	RETAINER	ARRÊT	HALTERUNG	BLOQUE
6	269450A3	RALLA	FIFTH WHEEL	COURONNE DENTÉE	DREHKRANZ	TEJUELO
6	269450H2	RALLA	FIFTH WHEEL	COURONNE DENTÉE	DREHKRANZ	TEJUELO
7	261308A3	MOTORE DI ROTAZIONE	ROTARY MOTOR	MOTEUR DE ROTATION	ROTATIONSMOTOR	MOTOR DE ROTACIÓN
7	261308H2	MOTORE DI ROTAZIONE	ROTARY MOTOR	MOTEUR DE ROTATION	ROTATIONSMOTOR	MOTOR DE ROTACIÓN
8	07178700	CERNIERA CON CONTROLLO DELLA POSIZIONE	HINGES WITH POSITION CONTROL	CHARNIÈRE	SCHARNIER	BISAGRA
9	07343200	VITE IMPERDIBILE ZIGRINATA CORTA	SHORT IMPERDIBLE KNURLED SCREW	VIS IMPERDABLE	SCHRAUBE	TORNILLO IMPERDIBLE
10	07343300	RICETTACOLO PER VITE IMPERDIBILE	RECEPTACLE FOR IMPERDIBLE SCREW	PRISE DE VIS POUR VIS IMPERDABLE	AUFNAHME FÜR SCHRAUBE	REFUGIO TORNILLO IMPERDIBLE
11	07343400	AGGANCIO PER VITE IMPERDIBILE	COUPLING FOR IMPERDIBLE SCREW	CROCHET VIS IMPERDABLE	HAKEN FÜR SCHRAUBE	GANCHO TORNILLO IMPERDIBLE
12	077481A3	COPERCHIO VANO BATTERIA	COVER BATTERY COMPARTMENT	COUVERCLE	DECKEL	TAPA
12	077481A6	COPERCHIO VANO BATTERIA	COVER BATTERY COMPARTMENT	COUVERCLE	DECKEL	TAPA
12	077481A8	COPERCHIO VANO BATTERIA	COVER BATTERY COMPARTMENT	COUVERCLE	DECKEL	TAPA
12	077481B1	COPERCHIO VANO BATTERIA	COVER BATTERY COMPARTMENT	COUVERCLE	DECKEL	TAPA
12	077481C4	COPERCHIO VANO BATTERIA	COVER BATTERY COMPARTMENT	COUVERCLE	DECKEL	TAPA
12	077481CD	COPERCHIO VANO BATTERIA	COVER BATTERY COMPARTMENT	COUVERCLE	DECKEL	TAPA
12	077481DQ	COPERCHIO VANO BATTERIA	COVER BATTERY COMPARTMENT	COUVERCLE	DECKEL	TAPA



Main color codes:  J1 - JLG Cream,  J2 - JLG Orange,  C4 - Green

 BASE TORRETTA





 TURRET BASE



 BASE TOURELLE
ARBEITSTURM BASE TORRETTA GIRATORIA 

POS	Codice	 Descrizione	 Description	 Designation	 Benennung	 Descripción
12	077481EW	COPERCHIO VANO BATTERIA	COVER BATTERY COMPARTMENT	COUVERCLE	DECKEL	TAPA
12	077481H1	COPERCHIO VANO BATTERIA	COVER BATTERY COMPARTMENT	COUVERCLE	DECKEL	TAPA
12	077481J2	COPERCHIO VANO BATTERIA	COVER BATTERY COMPARTMENT	COUVERCLE	DECKEL	TAPA
13	077446A3	TAPPO	CAP	COUVERCLE	ABDECKUNG	TAPA
13	077446A6	TAPPO LATERALE	CAP	BOUCHON	VERSCHLUSS	TAPA
13	077446A8	TAPPO	CAP	COUVERCLE	ABDECKUNG	TAPA
13	077446B1	TAPPO	CAP	COUVERCLE	ABDECKUNG	TAPA
13	077446C4	TAPPO LATERALE	CAP	COUVERCLE	DECKEL	TAPA
13	077446CD	TAPPO LATERALE	CAP	BOUCHON	VERSCHLUSS	TAPA
13	077446DQ	TAPPO	CAP	COUVERCLE	ABDECKUNG	TAPA
13	077446EW	TAPPO	CAP	COUVERCLE	ABDECKUNG	TAPA
13	077446H1	TAPPO	CAP	COUVERCLE	ABDECKUNG	TAPA
13	077446J2	TAPPO LATERALE	CAP	BOUCHON	VERSCHLUSS	TAPA
14	377414A3	BASE LL1570 SALDATA	BASE LL1570 WELDED	BASE LL1570 SAUDÉE	LL1570 GESCHWEISSTE BASIS	BASE SOLDATA LL1570
14	377414H2	BASE LL1570 SALDATA	BASE LL1570 WELDED	BASE LL1570 SAUDÉE	LL1570 GESCHWEISSTE BASIS	BASE SOLDATA LL1570
15	377732A3	ASSIEME SUPPORTO COMPONENTI ELETTRICI LL1570 SALDATO	ASSEMBLY SUPPORT ELECTRICAL COMPONENTS LL1570 WELDED	ENSEMBLE SUPPORT COMPOSANT ÉLECTRIQUES LL1570	HALTERUNG FÜR ELEKTRISCHE KOMPONENTEN	SOPORTE COMPONENTES ELÉCTRICOS
15	377732H2	ASSIEME SUPPORTO COMPONENTI ELETTRICI LL1570 SALDATO	ASSEMBLY SUPPORT ELECTRICAL COMPONENTS LL1570 WELDED	ENSEMBLE SUPPORT COMPOSANT ÉLECTRIQUES LL1570	HALTERUNG FÜR ELEKTRISCHE KOMPONENTEN	SOPORTE COMPONENTES ELÉCTRICOS
16	377439A3	SCATOLA IMPIANTO IDRAULICO LL1570 SALDATA	BOX HYDRAULIC LL1570 WELDED	BOÎTIER INSTALLATION HYDRAULIQUE	GEHÄUSE FÜR HYDRAULISCHE ANLAGE	CAJA INSTALACIÓN HIDRÁULICA
16	377439A6	SCATOLA IMPIANTO IDRAULICO LL1570 SALDATA	BOX HYDRAULIC LL1570 WELDED	BOÎTIER INSTALLATION HYDRAULIQUE	GEHÄUSE FÜR HYDRAULISCHE ANLAGE	CAJA INSTALACIÓN HIDRÁULICA

Main color codes:  J1 - JLG Cream,  J2 - JLG Orange,  C4 - Green

 BASE TORRETTA TURRET BASE BASE TOURELLEARBEITSTURM BASE TORRETTA GIRATORIA 

POS	Codice	 Descrizione	 Description	 Designation	 Benennung	 Descripción
16	377439A8	SCATOLA IMPIANTO IDRAULICO LL1570 SALDATA	BOX HYDRAULIC LL1570 WELDED	BOÎTIER INSTALLATION HYDRAULIQUE	GEHÄUSE FÜR HYDRAULISCHE ANLAGE	CAJA INSTALACIÓN HIDRÁULICA
16	377439B1	SCATOLA IMPIANTO IDRAULICO LL1570 SALDATA	BOX HYDRAULIC LL1570 WELDED	BOÎTIER INSTALLATION HYDRAULIQUE	GEHÄUSE FÜR HYDRAULISCHE ANLAGE	CAJA INSTALACIÓN HIDRÁULICA
16	377439C4	SCATOLA IMPIANTO IDRAULICO LL1570 SALDATA	BOX HYDRAULIC LL1570 WELDED	BOÎTE	GEHÄUSE	CAJA
16	377439CD	SCATOLA IMPIANTO IDRAULICO LL1570 SALDATA	BOX HYDRAULIC LL1570 WELDED	BOÎTIER INSTALLATION HYDRAULIQUE	GEHÄUSE FÜR HYDRAULISCHE ANLAGE	CAJA INSTALACIÓN HIDRÁULICA
16	377439DQ	SCATOLA IMPIANTO IDRAULICO	BOX HYDRAULIC	BOITE	GEHÄUSE	CAJA
16	377439EW	SCATOLA IMPIANTO IDRAULICO	BOX HYDRAULIC	BOITE	GEHÄUSE	CAJA
16	377439H1	SCATOLA IMPIANTO IDRAULICO	BOX HYDRAULIC	BOITE	GEHÄUSE	CAJA
16	377439J2	SCATOLA IMPIANTO IDRAULICO LL1570 SALDATA	BOX HYDRAULIC LL1570 WELDED	BOÎTIER INSTALLATION HYDRAULIQUE	GEHÄUSE FÜR HYDRAULISCHE ANLAGE	CAJA INSTALACIÓN HIDRÁULICA
17	077447A3	COPERCHIO VANO COMPONENTI IDRAULICI	COVER HYDRAULIC COMPONENTS	COUVERCLE	ABDECKUNG	TAPA
17	077447A6	COPERCHIO VANO COMPONENTI IDRAULICI	COVER COMPARTMENT HYDRAULIC COMPONENTS	COUVERCLE	DECKEL	TAPA
17	077447A8	COPERCHIO VANO COMPONENTI IDRAULICI	COVER HYDRAULIC COMPONENTS	COUVERCLE	ABDECKUNG	TAPA
17	077447B1	COPERCHIO VANO COMPONENTI IDRAULICI	COVER HYDRAULIC COMPONENTS	COUVERCLE	ABDECKUNG	TAPA



Main color codes:  J1 - JLG Cream,  J2 - JLG Orange,  C4 - Green

 BASE TORRETTA



 TURRET BASE



 BASE TOURELLE
ARBEITSTURM BASE TORRETTA GIRATORIA 

POS	Codice	 Descrizione	 Description	 Designation	 Benennung	 Descripción
17	077447C4	COPERCHIO VANO COMPONENTI IDRAULICI	COVER COMPARTMENT HYDRAULIC COMPONENTS	COUVERCLE	DECKEL	TAPA
17	077447CD	COPERCHIO VANO COMPONENTI IDRAULICI	COVER COMPARTMENT HYDRAULIC COMPONENTS	COUVERCLE	DECKEL	TAPA
17	077447DQ	COPERCHIO COMPONENTI ELETTRICI	COVER ELECTRICAL COMPONENTS	COUVERCLE	ABDECKUNG	TAPA
17	077447EW	COPERCHIO VANO COMPONENTI IDRAULICI	COVER HYDRAULIC COMPONENTS	COUVERCLE	ABDECKUNG	TAPA
17	077447H1	COPERCHIO VANO COMPONENTI IDRAULICI	COVER HYDRAULIC COMPONENTS	COUVERCLE	ABDECKUNG	TAPA
17	077447J2	COPERCHIO VANO COMPONENTI IDRAULICI	COVER COMPARTMENT HYDRAULIC COMPONENTS	COUVERCLE	DECKEL	TAPA
18	07599600	BOCCOLA 25X30 L30 HSG	BUSH 25X30 L30 HSG	DOUILLE 25X30 L30 HSG	BUCHSE 25X30 L30 HSG	CASQUILLO 25X30 L30 HSG
20	05446300	DISCO	DISK	DISQUE	SCHEIBE	DISCO
21	073147Y1	SEMIFLANGIA	HALF FLANGE	DEMI-BRIDE	HALB FLANSCH	SEMI BRIDA
22	177406A3	ASSIEME STABILIZZATORE COMPLETO	ASSEMBLY COMPLETE STABILIZE	STABILISATEUR	ABSTÜTZUNG	ESTABILIZADOR
22	177406A6	ASSIEME STABILIZZATORE COMPLETO	ASSEMBLY COMPLETE STABILIZE	STABILISATEUR	ABSTÜTZUNG	ESTABILIZADOR
22	177406A8	ASSIEME STABILIZZATORE COMPLETO	ASSEMBLY COMPLETE STABILIZE	STABILISATEUR	ABSTÜTZUNG	ESTABILIZADOR

Main color codes:  J1 - JLG Cream,  J2 - JLG Orange,  C4 - Green

 BASE TORRETTA TURRET BASE BASE TOURELLEARBEITSTURM BASE TORRETTA GIRATORIA 





POS	Codice	 Descrizione	 Description	 Designation	 Benennung	 Descripción
22	177406B1	ASSIEME STABILIZZATORE COMPLETO	ASSEMBLY COMPLETE STABILIZE	STABILISATEUR	ABSTÜTZUNG	ESTABILIZADOR
22	177406C4	ASSIEME STABILIZZATORE COMPLETO	ASSEMBLY COMPLETE STABILIZE	STABILISATEUR	ABSTÜTZUNG	ESTABILIZADOR
22	177406CD	ASSIEME STABILIZZATORE COMPLETO	ASSEMBLY COMPLETE STABILIZE	STABILISATEUR	ABSTÜTZUNG	ESTABILIZADOR
22	177406DQ	ASSIEME STABILIZZATORE COMPLETO	ASSEMBLY COMPLETE STABILIZE	STABILISATEUR	ABSTÜTZUNG	ESTABILIZADOR
22	177406EW	ASSIEME STABILIZZATORE COMPLETO	ASSEMBLY COMPLETE STABILIZE	STABILISATEUR	ABSTÜTZUNG	ESTABILIZADOR
22	177406H1	ASSIEME STABILIZZATORE COMPLETO	ASSEMBLY COMPLETE STABILIZE	STABILISATEUR	ABSTÜTZUNG	ESTABILIZADOR
22	177406H2	ASSIEME STABILIZZATORE COMPLETO	ASSEMBLY COMPLETE STABILIZER	STABILISATEUR COMPLET	ABSTÜTZUNG KOMPLETT	ESTABILIZADOR COMPLETO
22	177406J2	ASSIEME STABILIZZATORE COMPLETO	ASSEMBLY COMPLETE STABILIZE	STABILISATEUR	ABSTÜTZUNG	ESTABILIZADOR
23	376018A3	SUPPORTO SPIA STABILIZZATORE (FOR LL2010-X20JP- X600AJ MK2 FROM C170000893)	OUTRIGGER LIGHT SUPPORT (FOR LL2010-X20JP-X600AJ MK2 FROM C170000893)	SUPPORT LUMIÈRE STABILISATEUR (FOR LL2010-X20JP-X600AJ MK2 FROM C170000893)	LICHTHALTERUNG (FOR LL2010-X20JP- X600AJ MK2 FROM C170000893)	SOPORTE LUZ (FOR LL2010-X20JP-X600AJ MK2 FROM C170000893)
23	376018H2	SUPPORTO SPIA STABILIZZATORE (FOR LL2010-X20JP- X600AJ MK2 FROM C170000893)	OUTRIGGER LIGHT SUPPORT (FOR LL2010-X20JP-X600AJ MK2 FROM C170000893)	SUPPORT LUMIÈRE STABILISATEUR (FOR LL2010-X20JP-X600AJ MK2 FROM C170000893)	LICHTHALTERUNG (FOR LL2010-X20JP- X600AJ MK2 FROM C170000893)	SOPORTE LUZ (FOR LL2010-X20JP-X600AJ MK2 FROM C170000893)



Main color codes:  J1 - JLG Cream,  J2 - JLG Orange,  C4 - Green

 BASE TORRETTA

 TURRET BASE

 BASE TOURELLE
ARBEITSTURM BASE TORRETTA GIRATORIA 



POS	Codice	 Descrizione	 Description	 Designation	 Benennung	 Descripción
24	07894900	GOMMA ADESIVA DI PROTEZIONE L=70	RUBBER ADHESIVE PROTECTION L=70	GOMME ADHESIVE DE PROTECTION L=70	SCHUTZ-KLEBEGUMMI L=70	GOMA ADHESIVA DE PROTECCIÓN L=70
25	072700A3	CARTER DI PROTEZIONE	PROTECTION COVER	CARTER DE DE PROTECTION	CARTER VON SCHUTZ	CARTER DE PROTECCIÓN
25	072700H2	CARTER DI PROTEZIONE	PROTECTION COVER	CARTER DE PROTECTION	CARTER VON SCHUTZ	CARTER DE PROTECCIÓN
26	382960A3	SUPPORTO MOTORE TERMICO LL1570 SALDATO	SUPPORT ENGINE LL1570 WELDED	SUPPORT MOTEUR	HALTERUNG FÜR MOTOR	SOPORTE MOTOR
26	382960H2	SUPPORTO MOTORE TERMICO	ENGINE SUPPORT	SUPPORT MOTEUR HINOWA GREY	MOTORHALTERUNG HINOWA GREY	SOPORTE MOTOR HINOWA GREY
27	282209A3	CILINDRO STABILIZZATORE	OUTRIGGER CYLINDER	VÉRIN STABILISATEUR	STÜTZFUßZYLINDER	CILINDRO ESTABILIZADOR
27	282209H2	CILINDRO STABILIZZATORE	OUTRIGGER CYLINDER	VÉRIN STABILISATEUR HINOWA GREY	STÜTZFUßZYLINDER HINOWA GREY	CILINDRO ESTABILIZADOR HINOWA GREY
28	377953A3	COFANO MOTORE DIESEL	ENGINE COVER DIESEL	CAPOT	MOTORHAUBE	CAPÓ
28	377953H2	COFANO MOTORE DIESEL	ENGINE COVER DIESEL	CAPOT	MOTORHAUBE	CAPÓ
28	377954A3	COFANO MOTORE BENZINA	ENGINE COVER PETROL	CAPOT MOTEUR ESSENCE	MOTORHAUBE FÜR BENZIN MOTOR	CAPÓ PARA MOTOR DE GASOLINA
28	377954H2	COFANO MOTORE BENZINA	ENGINE COVER PETROL	CAPOT MOTEUR ESSENCE	MOTORHAUBE FÜR BENZIN MOTOR	CAPÓ PARA MOTOR DE GASOLINA
29	07754600	SPINA OCCHIO CILINDRO STABILIZZATORE LL1570-X15JP-X430AJ	PIN EYE CYLINDER STABILIZER LL1570-X15JP-X430AJ	AXE	STIFT	CLAVIJA
30	077413A3	PIEGATO PROTEZIONE MICRO STABILIZZATORE	BENT PROTECTION MICRO STABILIZER	PROTECTION MICROINTERRUPTEUR	SCHUTZABDECKUNG MIKROSCHALTER	PROTECCIÓN MICROINTERRUPTOR
30	077413H2	PIEGATO PROTEZIONE MICRO STABILIZZATORE	BENT PROTECTION MICRO STABILIZER	PROTECTION MICROINTERRUPTEUR	SCHUTZABDECKUNG MIKROSCHALTER	PROTECCIÓN MICROINTERRUPTOR



Main color codes:  J1 - JLG Cream,  J2 - JLG Orange,  C4 - Green

 BASE TORRETTA

 TURRET BASE

 BASE TOURELLE
ARBEITSTURM BASE TORRETTA GIRATORIA 





POS	Codice	 Descrizione	 Description	 Designation	 Benennung	 Descripción
31	28185800	ANTIVIBRANTE	ANTI-VIBRATING	ANTI - VIBRANT	VIBRATIONSDÄMPFER	ANTIVIBRANTE
32	07772000	PERNO ATTACCO STABILIZZATORE A BASE LL1570-X15JP-X430AJ	PIN CONNECTION STABILIZER BASED LL1570-X15JP-X430AJ	AXE	STIFT	PERNIO
33	064966Y1	GOCCIA SPINA	PIN DROP	BAISSE CHEVILLE	TROPFEN STIFT	CAÍDA CLAVIJA
34	077955A3	COPERCHIO PER ACCESSO A FILTRO ARIA SU MOTORE BENZINA	COVER FOR ACCESS TO AIR FILTER ON GASOLINE ENGINE	COUVERCLE	DECKEL	TAPA
34	077955H2	COPERCHIO PER ACCESSO A FILTRO ARIA SU MOTORE BENZINA	COVER FOR ACCESS TO AIR FILTER ON GASOLINE ENGINE	COUVERCLE	DECKEL	TAPA
34	077955NV	COPERCHIO PER ACCESSO A FILTRO ARIA SU MOTORE	COVER FOR ACCESS TO AIR FILTER ON GASOLINE ENGINE	COUVERCLE	DECKEL	TAPA
35	055629H3	STAFFA	BRACKET	ÉTRIER	HALTEBÜGEL	ESTRIBO
37	077742A3	COFANO MOTORE ELETTRICO	ELECTRIC ENGINE COVER	CAPOT	MOTOR HAUBE	CAPÓ
37	077742H2	COFANO MOTORE ELETTRICO	ELECTRIC ENGINE COVER	CAPOT	MOTOR HAUBE	CAPÓ
38	077743A3	PORTELLO LATERALE MANUTENZIONE MOTORE ELETTRICO	DOOR LATERAL MAINTENANCE ELECTRIC MOTOR	GUICHET	ABDECKPLATTE	PORTILLA
38	077743H2	PORTELLO LATERALE MANUTENZIONE MOTORE ELETTRICO	DOOR LATERAL MAINTENANCE ELECTRIC MOTOR	GUICHET	ABDECKPLATTE	PORTILLA
39	077744A3	PORTELLO ACCESSO CHIAVE EMERGENZE	DOOR ACCESS KEY EMERGENCIAS	GUICHET	ABDECKPLATTE	PORTILLA
39	077744H2	PORTELLO ACCESSO CHIAVE EMERGENZE	DOOR ACCESS KEY EMERGENCIAS	GUICHET	ABDECKPLATTE	PORTILLA



Main color codes:  J1 - JLG Cream,  J2 - JLG Orange,  C4 - Green



 BASE TORRETTA

 TURRET BASE



 BASE TOURELLE
ARBEITSTURM BASE TORRETA GIRATORIA 



POS	Codice	 Descrizione	 Description	 Designation	 Benennung	 Descripción
41	077745Y1	PIATTO FISSAGGIO FOTOCPELLULA CATAFORESI	PLATE FIXING PHOTOCELL	PLAQUE	PLATTE	PLACA
42	061185Y1	LAMIERA PIEGATA	FOLDED PLATE	TÔLE PLIÉE	BLECH GEBOGEN	CHAPA DOBLADA
43	077738Y1	PIEGATO FISSAGGIO COMPONENTI ELETTRICI LL1570	BENT FIXING ELECTRICAL COMPONENTS LL1570	SUPPORT	HALTERUNG	SOPORTE
45	077740Y1	PARATIA SUPERIORE MOTORE ELETTRICO LL1570	UPPER PLATE ELECTRIC MOTOR LL1570	PLAQUE	PLATTE	PLACA
46	077721D2	INDICE ALLINEAMENTO FISSO LL1570	ALIGNMENT INDEX FIXED LL1570	INDEX	INDEX	ÍNDICE

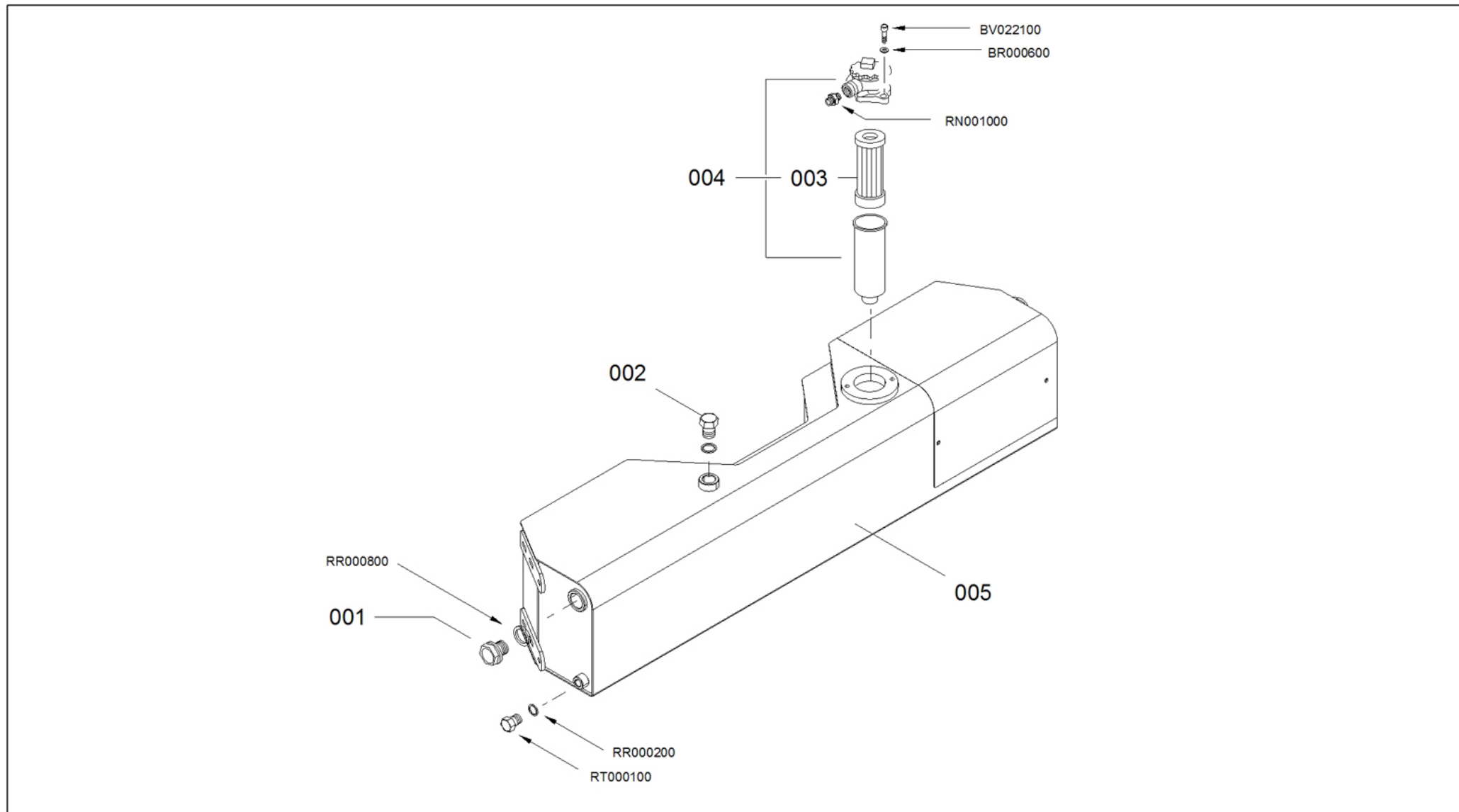

-  SERBATOIO OLIO
-  OIL TANK
-  RÉSERVOIR D'HUILE





ÖLTANK 
DEPÓSITO DE ACEITE 



Main color codes:  J1 - JLG Cream,  J2 - JLG Orange,  C4 - Green

 SERBATOIO OLIO
 OIL TANK
 RÉSERVOIR D'HUILE

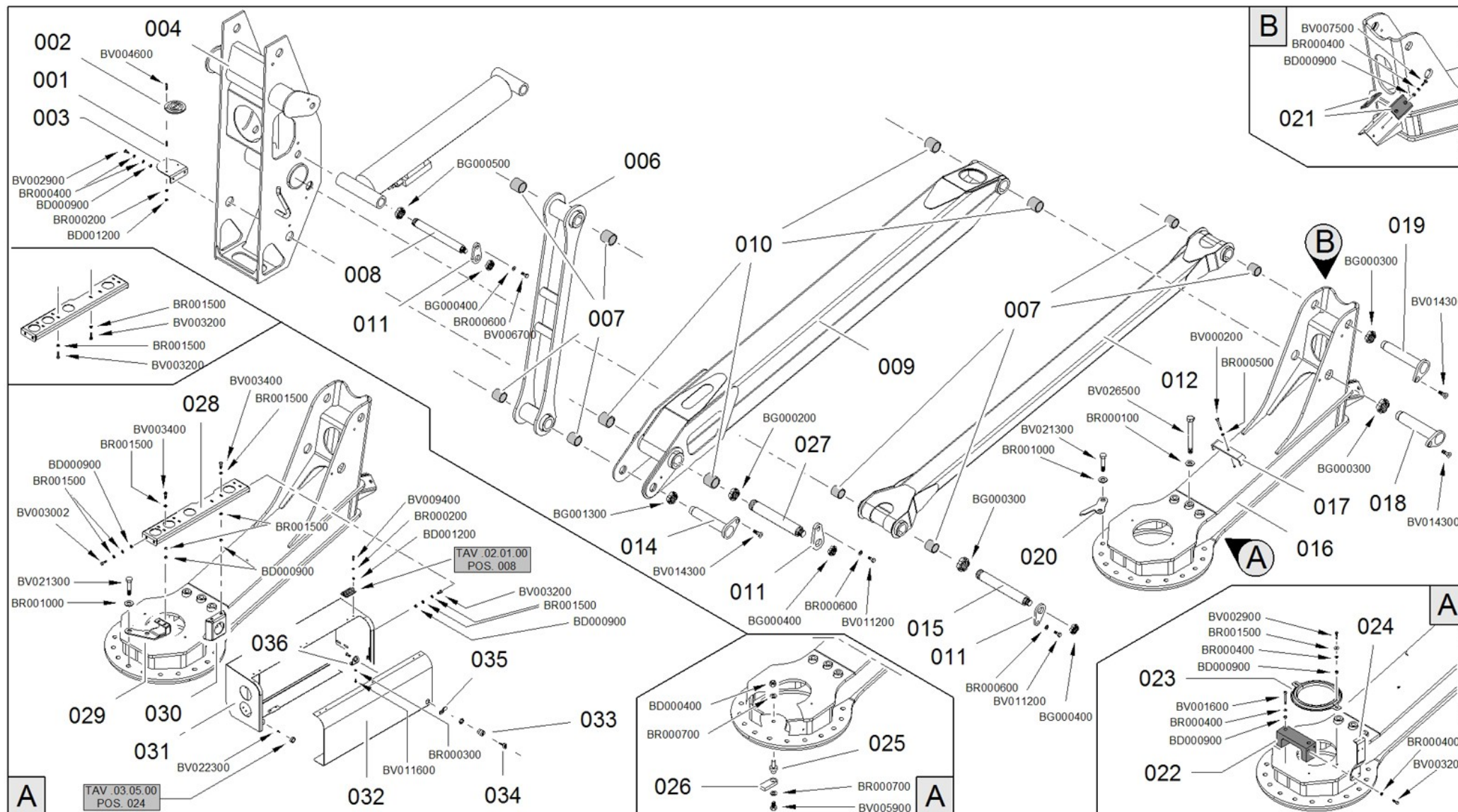

ÖLTANK 
 DEPÓSITO DE ACEITE 

POS	Codice	 Descrizione	 Description	 Designation	 Benennung	 Descripción
1	05061800	LIVELLO OLIO	OIL LEVEL	NIVEAU HUILE	ÖLSTAND	NIVEL ACEITE
2	05611800	TAPPO OLIO	OIL PLUG	BOUCHON D'HUILE	ÖLDECKEL	TAPÓN ACEITE
3	05120200	CARTUCCIA FILTRO OLIO IDRAULICO	HYDRAULIC FILTER	CARTOUCHE FILTRE À HUILE	ÖLFILTEREINSATZ	CARTUCHO FILTRO ACEITE
4	15120100	FILTRO OLIO IDRAULICO COMPLETO	COMPLETE HYDRAULIC OIL FILTER	FILTRE À HUILE	HYDARULIKÖLFILTE R	FILTRO ACEITE HIDRÁULICO
5	177477A3	SERBATOIO OLIO COMPLETO LL1570	OIL TANK LL1570	RÉSERVOIR HUILE	ÖLTANK	DEPÓSITO DE ACEITE
5	177477A6	SERBATOIO OLIO COMPLETO LL1570	OIL TANK LL1570	RÉSERVOIR HUILE	ÖLTANK	DEPÓSITO DE ACEITE
5	177477A8	SERBATOIO OLIO COMPLETO LL1570	OIL TANK LL1570	RÉSERVOIR HUILE	ÖLTANK	DEPÓSITO DE ACEITE
5	177477B1	SERBATOIO OLIO COMPLETO LL1570	OIL TANK LL1570	RÉSERVOIR HUILE	ÖLTANK	DEPÓSITO DE ACEITE
5	177477C4	SERBATOIO OLIO COMPLETO LL1570	OIL TANK LL1570	RESERVOIR HUILE	ÖLTANK	DEPÓSITO DE ACEITE
5	177477CD	SERBATOIO OLIO COMPLETO LL1570	OIL TANK LL1570	RÉSERVOIR HUILE	ÖLTANK	DEPÓSITO DE ACEITE
5	177477DQ	SERBATOIO OLIO COMPLETO	OIL TANK COMPLETE	RESERVOIR HUILE COMPLET	ÖLTANK KOMPLETT	DEPOSITO ACEITE COMPLETO
5	177477EW	SERBATOIO OLIO COMPLETO	OIL TANK COMPLETE	RESERVOIR HUILE COMPLET	ÖLTANK KOMPLETT	DEPOSITO ACEITE COMPLETO
5	177477H1	SERBATOIO OLIO COMPLETO	OIL TANK COMPLETE	RESERVOIR HUILE COMPLET	ÖLTANK KOMPLETT	DEPOSITO ACEITE COMPLETO
5	177477J2	SERBATOIO OLIO COMPLETO LL1570	OIL TANK LL1570	RÉSERVOIR HUILE	ÖLTANK	DEPÓSITO DE ACEITE



 PRIMO BRACCIO FIRST ARM PREMIER BRASERSTER AUSLEGERARM PRIMO BRAZO 



POS	Codice	 Descrizione	 Description	 Designation	 Benennung	 Descripción
1	05444800	MOLLA	SPRING	RESSORT	FEDER	MUELLE
2	05427200	LIVELLA	LEVEL	NIVEAU	WASSERWAAGE	NIVEL DE BURBUJA
3	058832H3	SUPPORTO	SUPPORT	SUPPORT	HALTERUNG	SOPORTE
4	377599A6	RINVIO PRIMO- SECONDO BRACCIO LL1570 SALDATO	REFERENCE FIRST- SECOND BOOM LL1570 WELDED	RENVOI	VORGELEGE	REENVIO
4	377599A7	RINVIO PRIMO- SECONDO BRACCIO LL1570 SALDATO	REFERENCE FIRST- SECOND BOOM LL1570 WELDED	RENVOI	VORGELEGE	REENVIO
4	377599A8	RINVIO PRIMO- SECONDO BRACCIO LL1570 SALDATO	REFERENCE FIRST- SECOND BOOM LL1570 WELDED	RENVOI	VORGELEGE	REENVIO
4	377599B1	RINVIO PRIMO- SECONDO BRACCIO LL1570 SALDATO	REFERENCE FIRST- SECOND BOOM LL1570 WELDED	RENVOI	VORGELEGE	REENVIO
4	377599B6	RINVIO PRIMO- SECONDO BRACCIO LL1570 SALDATO	REFERENCE FIRST- SECOND BOOM LL1570 WELDED	RENVOI	VORGELEGE	REENVIO
4	377599BP	RINVIO PRIMO- SECONDO BRACCIO LL1570 SALDATO	REFERENCE FIRST- SECOND BOOM LL1570 WELDED	RENVOI	VORGELEGE	REENVIO
4	377599BR	RINVIO PRIMO- SECONDO BRACCIO LL1570 SALDATO	REFERENCE FIRST- SECOND BOOM LL1570 WELDED	RENVOI	VORGELEGE	REENVIO
4	377599C4	RINVIO PRIMO- SECONDO BRACCIO LL1570 SALDATO	REFERENCE FIRST- SECOND BOOM LL1570 WELDED	RENVOI	VORGELEGE	REENVIO
4	377599FX	RINVIO PRIMO- SECONDO BRACCIO LL1570 SALDATO	REFERENCE FIRST- SECOND BOOM LL1570 WELDED	RENVOI	VORGELEGE	REENVIO
4	377599GB	RINVIO PRIMO- SECONDO BRACCIO LL1570 SALDATO	REFERENCE FIRST- SECOND BOOM LL1570 WELDED	RENVOI	VORGELEGE	REENVIO



Main color codes:  J1 - JLG Cream,  J2 - JLG Orange,  C4 - Green

 PRIMO BRACCIO

 FIRST ARM

 PREMIER BRAS
ERSTER AUSLEGERARM PRIMO BRAZO 





POS	Codice	 Descrizione	 Description	 Designation	 Benennung	 Descripción
4	377599H1	RINVIO PRIMO- SECONDO BRACCIO	REFERENCE FIRST- SECOND BOOM	RENVOI PREMIER- DEUXIEME BRAS	VORGELEGE ERSTER- ZWEITER ARM	REENVIO PRIMERO- SEGUNDO BRAZO
4	377599J1	RINVIO PRIMO- SECONDO BRACCIO LL1570 SALDATO	REFERENCE FIRST- SECOND BOOM LL1570 WELDED	RENVOI	VORGELEGE	REENVIO
4	377599J2	RINVIO PRIMO- SECONDO BRACCIO	REFERENCE FIRST- SECOND BOOM	RENVOI PREMIER- DEUXIEME BRAS	VORGELEGE ERSTER- ZWEITER ARM	REENVIO PRIMERO- SEGUNDO BRAZO
6	177114A6	BIELLA PRIMO- SECONDO BRACCIO LL1570 COMPLETA	CONNECTING ROD COMPLETE FIRST- SECOND BOOM LL1570	BIELLE	PLEUELSTANGE	BIELA
6	177114A7	BIELLA PRIMO- SECONDO BRACCIO LL1570 COMPLETA	CONNECTING ROD COMPLETE FIRST- SECOND BOOM LL1570	BIELLE	PLEUELSTANGE	BIELA
6	177114A8	BIELLA PRIMO- SECONDO BRACCIO LL1570 COMPLETA	CONNECTING ROD COMPLETE FIRST- SECOND BOOM LL1570	BIELLE	PLEUELSTANGE	BIELA
6	177114B1	BIELLA PRIMO- SECONDO BRACCIO LL1570 COMPLETA	CONNECTING ROD COMPLETE FIRST- SECOND BOOM LL1570	BIELLE	PLEUELSTANGE	BIELA
6	177114B6	BIELLA PRIMO- SECONDO BRACCIO LL1570 COMPLETA	CONNECTING ROD COMPLETE FIRST- SECOND BOOM LL1570	BIELLE	PLEUELSTANGE	BIELA
6	177114BP	BIELLA PRIMO- SECONDO BRACCIO LL1570 COMPLETA	CONNECTING ROD COMPLETE FIRST- SECOND BOOM LL1570	BIELLE	PLEUELSTANGE	BIELA



Main color codes:  J1 - JLG Cream,  J2 - JLG Orange,  C4 - Green

 PRIMO BRACCIO

 FIRST ARM

 PREMIER BRAS
ERSTER AUSLEGERARM PRIMO BRAZO 





POS	Codice	 Descrizione	 Description	 Designation	 Benennung	 Descripción
6	177114BR	BIELLA PRIMO- SECONDO BRACCIO LL1570 COMPLETA	CONNECTING ROD COMPLETE FIRST- SECOND BOOM LL1570	BIELLE	PLEUELSTANGE	BIELA
6	177114C4	BIELLA PRIMO- SECONDO BRACCIO LL1570 COMPLETA	CONNECTING ROD COMPLETE FIRST- SECOND BOOM LL1570	BIELLE	PLEUEL	BIELA
6	177114FX	BIELLA PRIMO- SECONDO BRACCIO LL1570 COMPLETA	CONNECTING ROD COMPLETE FIRST- SECOND BOOM LL1570	BIELLE	PLEUELSTANGE	BIELA
6	177114GB	BIELLA PRIMO- SECONDO BRACCIO LL1570 COMPLETA	CONNECTING ROD COMPLETE FIRST- SECOND BOOM LL1570	BIELLE	PLEUELSTANGE	BIELA
6	177114H1	BIELLA PRIMO- SECONDO BRACCIO	ROD FIRST-SECOND BOOM	BIELLE	PLEUELSTANGE	BIELA
6	177114J1	BIELLA PRIMO- SECONDO BRACCIO LL1570 COMPLETA	CONNECTING ROD COMPLETE FIRST- SECOND BOOM LL1570	BIELLE	PLEUELSTANGE	BIELA
6	177114J2	BIELLA PRIMO- SECONDO BRACCIO	ROD FIRST-SECOND BOOM	BIELLE	PLEUELSTANGE	BIELLE
7	07765100	BOCCOLA DEVA.TEX552 354040	BUSH DEVA. TEX 552 354040	DOUILLE	BUCHSE	CASQUILLO
8	07755000	SPINA FONDELLO CILINDRO 1°2°BRACCIO LL1570- X15JP-X430AJ	PIN BOTTOM CYLINDER 1ST 2ND ARM LL1570-X15JP- X430AJ	AXE	STIFT	CLAVIJA
9	177590A6	PRIMO BRACCIO LL1570 COMPLETO	FIRST COMPLETE BOOM LL1570	PREMIER BRAS	ERSTER ARM	PRIMERO BRAZO
9	177590A7	PRIMO BRACCIO LL1570 COMPLETO	FIRST COMPLETE BOOM LL1570	PREMIER BRAS	ERSTER ARM	PRIMERO BRAZO



Main color codes:  J1 - JLG Cream,  J2 - JLG Orange,  C4 - Green

 PRIMO BRACCIO

 FIRST ARM

 PREMIER BRAS
ERSTER AUSLEGERARM PRIMO BRAZO 





POS	Codice	 Descrizione	 Description	 Designation	 Benennung	 Descripción
9	177590A8	PRIMO BRACCIO LL1570 COMPLETO	FIRST COMPLETE BOOM LL1570	PREMIER BRAS	ERSTER ARM	PRIMERO BRAZO
9	177590B1	PRIMO BRACCIO LL1570 COMPLETO	FIRST COMPLETE BOOM LL1570	PREMIER BRAS	ERSTER ARM	PRIMERO BRAZO
9	177590B6	PRIMO BRACCIO LL1570 COMPLETO	FIRST COMPLETE BOOM LL1570	PREMIER BRAS	ERSTER ARM	PRIMERO BRAZO
9	177590BP	PRIMO BRACCIO LL1570 COMPLETO	FIRST COMPLETE BOOM LL1570	PREMIER BRAS	ERSTER ARM	PRIMERO BRAZO
9	177590BR	PRIMO BRACCIO LL1570 COMPLETO	FIRST COMPLETE BOOM LL1570	PREMIER BRAS	ERSTER ARM	PRIMERO BRAZO
9	177590C4	PRIMO BRACCIO LL1570 COMPLETO	FIRST COMPLETE BOOM LL1570	PREMIER BRAS	ERSTER ARM	PRIMERO BRAZO
9	177590FX	PRIMO BRACCIO LL1570 COMPLETO	FIRST COMPLETE BOOM LL1570	PREMIER BRAS	ERSTER ARM	PRIMERO BRAZO
9	177590GB	PRIMO BRACCIO LL1570 COMPLETO	FIRST COMPLETE BOOM LL1570	PREMIER BRAS	ERSTER ARM	PRIMERO BRAZO
9	177590H1	PRIMO BRACCIO COMPLETO	FIRST BOOM COMPLETE	PREMIER BRAS COMPLET	ERSTER ARM KOMPLETT	PRIMERO BRAZO COMPLETO
9	177590J1	PRIMO BRACCIO LL1570 COMPLETO	FIRST COMPLETE BOOM LL1570	PREMIER BRAS	ERSTER ARM	PRIMERO BRAZO
9	177590J2	PRIMO BRACCIO COMPLETO	FIRST BOOM COMPLETE	PREMIER BRAS COMPLET	ERSTER ARM KOMPLETT	PRIMERO BRAZO COMPLETO
10	06434200	BOCCOLA	BUSH	DOUILLE	BUCHSE	CASQUILLO
11	064967Y1	GOCCIA SPINA	PIN DROP	BAISSE CHEVILLE	TROPFEN STIFT	CAÍDA CLAVIJA
12	177117A6	TIRANTE PRIMO BRACCIO LL1570 COMPLETO	TIE ROD BOOM COMPLETE FIRST LL1570	TIRANT PREMIER BRAS	SPANNSTANGE ERSTER ARM	TIRANTE PRIMERO BRAZO
12	177117A7	TIRANTE PRIMO BRACCIO LL1570 COMPLETO	TIE ROD BOOM COMPLETE FIRST LL1570	TIRANT PREMIER BRAS	SPANNSTANGE ERSTER ARM	TIRANTE PRIMERO BRAZO
12	177117A8	TIRANTE PRIMO BRACCIO LL1570 COMPLETO	TIE ROD BOOM COMPLETE FIRST LL1570	TIRANT PREMIER BRAS	SPANNSTANGE ERSTER ARM	TIRANTE PRIMERO BRAZO



Main color codes:  J1 - JLG Cream,  J2 - JLG Orange,  C4 - Green

 PRIMO BRACCIO

 FIRST ARM

 PREMIER BRAS
ERSTER AUSLEGERARM PRIMO BRAZO 





POS	Codice	 Descrizione	 Description	 Designation	 Benennung	 Descripción
12	177117B1	TIRANTE PRIMO BRACCIO LL1570 COMPLETO	TIE ROD BOOM COMPLETE FIRST LL1570	TIRANT PREMIER BRAS	SPANNSTANGE ERSTER ARM	TIRANTE PRIMERO BRAZO
12	177117B6	TIRANTE PRIMO BRACCIO LL1570 COMPLETO	TIE ROD BOOM COMPLETE FIRST LL1570	TIRANT PREMIER BRAS	SPANNSTANGE ERSTER ARM	TIRANTE PRIMERO BRAZO
12	177117BP	TIRANTE PRIMO BRACCIO LL1570 COMPLETO	TIE ROD BOOM COMPLETE FIRST LL1570	TIRANT PREMIER BRAS	SPANNSTANGE ERSTER ARM	TIRANTE PRIMERO BRAZO
12	177117BR	TIRANTE PRIMO BRACCIO LL1570 COMPLETO	TIE ROD BOOM COMPLETE FIRST LL1570	TIRANT PREMIER BRAS	SPANNSTANGE ERSTER ARM	TIRANTE PRIMERO BRAZO
12	177117C4	TIRANTE PRIMO BRACCIO LL1570 COMPLETO	TIE ROD BOOM COMPLETE FIRST LL1570	TIRANT	TURMGESTÄNGE	TIRANTE
12	177117FX	TIRANTE PRIMO BRACCIO LL1570 COMPLETO	TIE ROD BOOM COMPLETE FIRST LL1570	TIRANT PREMIER BRAS	SPANNSTANGE ERSTER ARM	TIRANTE PRIMERO BRAZO
12	177117GB	TIRANTE PRIMO BRACCIO LL1570 COMPLETO	TIE ROD BOOM COMPLETE FIRST LL1570	TIRANT PREMIER BRAS	SPANNSTANGE ERSTER ARM	TIRANTE PRIMERO BRAZO
12	177117H1	TIRANTE PRIMO BRACCIO	FIRST TIE BOOM	TIRANT	TURMGESTÄNGE	TIRANTE
12	177117J1	TIRANTE PRIMO BRACCIO LL1570 COMPLETO	TIE ROD BOOM COMPLETE FIRST LL1570	TIRANT PREMIER BRAS	SPANNSTANGE ERSTER ARM	TIRANTE PRIMERO BRAZO
12	177117J2	TIRANTE PRIMO BRACCIO	FIRST TIE BOOM	TIRANT	TURMGESTÄNGE	TIRANTE
13	2648910002	KIT GUARNIZIONI	SEAL KIT	KIT DE JOINTS	DICHTUNGSSATZ	KIT DE JUNTAS
14	07755200	PERNO ATTACCO BIELLA A 1°BRACCIO LL1570-X15JP-X430AJ	PIN CONNECTION ROD A 1ST ARM LL1570-X15JP-X430AJ	AXE	STIFT	CLAVIJA



Main color codes:  J1 - JLG Cream,  J2 - JLG Orange,  C4 - Green

 PRIMO BRACCIO

 FIRST ARM

 PREMIER BRAS
ERSTER AUSLEGERARM PRIMO BRAZO 

POS	Codice	 Descrizione	 Description	 Designation	 Benennung	 Descripción
15	07754900	PERNO ATTACCO TIRANTE 1°BRACCIO A RINVIO 1°2°BRACCIO LL1570- X15JP-X430AJ	PIN CONNECTION TIE 1ST ARM REFERENCE 1ST 2ND ARM LL1570- X15JP-X430AJ	AXE	STIFT	CLAVIJA
16	377429A6	SUPPORTO BRACCI LL1570 SALDATO	SUPPORT BOOMS LL1570 WELDED	SUPPORT DES BRAS LL1570 SOUDÉ	LL1570 GESCHWEISSTE HALTERUNG DER ÄRME	SOPORTE BRAZOS LL1570 SOLDADO
16	377429A7	SUPPORTO BRACCI LL1570 SALDATO	SUPPORT BOOMS LL1570 WELDED	SUPPORT DES BRAS LL1570 SOUDÉ	LL1570 GESCHWEISSTE HALTERUNG DER ÄRME	SOPORTE BRAZOS LL1570 SOLDADO
16	377429A8	SUPPORTO BRACCI LL1570 SALDATO	SUPPORT BOOMS LL1570 WELDED	SUPPORT DES BRAS LL1570 SOUDÉ	LL1570 GESCHWEISSTE HALTERUNG DER ÄRME	SOPORTE BRAZOS LL1570 SOLDADO
16	377429B1	SUPPORTO BRACCI LL1570 SALDATO	SUPPORT BOOMS LL1570 WELDED	SUPPORT DES BRAS LL1570 SOUDÉ	LL1570 GESCHWEISSTE HALTERUNG DER ÄRME	SOPORTE BRAZOS LL1570 SOLDADO
16	377429B6	SUPPORTO BRACCI LL1570 SALDATO	SUPPORT BOOMS LL1570 WELDED	SUPPORT DES BRAS LL1570 SOUDÉ	LL1570 GESCHWEISSTE HALTERUNG DER ÄRME	SOPORTE BRAZOS LL1570 SOLDADO
16	377429BP	SUPPORTO BRACCI LL1570 SALDATO	SUPPORT BOOMS LL1570 WELDED	SUPPORT DES BRAS LL1570 SOUDÉ	LL1570 GESCHWEISSTE HALTERUNG DER ÄRME	SOPORTE BRAZOS LL1570 SOLDADO
16	377429BR	SUPPORTO BRACCI LL1570 SALDATO	SUPPORT BOOMS LL1570 WELDED	SUPPORT DES BRAS LL1570 SOUDÉ	LL1570 GESCHWEISSTE HALTERUNG DER ÄRME	SOPORTE BRAZOS LL1570 SOLDADO



Main color codes:  J1 - JLG Cream,  J2 - JLG Orange,  C4 - Green

 PRIMO BRACCIO

 FIRST ARM

 PREMIER BRAS
ERSTER AUSLEGERARM PRIMO BRAZO 





POS	Codice	 Descrizione	 Description	 Designation	 Benennung	 Descripción
16	377429C4	SUPPORTO BRACCI LL1570 SALDATO	SUPPORT BOOMS LL1570 WELDED	SUPPORT BRAS	ÄRMEHALTERUNG	SOPORTE BRAZOS
16	377429FX	SUPPORTO BRACCI LL1570 SALDATO	SUPPORT BOOMS LL1570 WELDED	SUPPORT DES BRAS LL1570 SOUDÉ	LL1570 GESCHWEISSTE HALTERUNG DER ÄRME	SOPORTE BRAZOS LL1570 SOLDADO
16	377429GB	SUPPORTO BRACCI LL1570 SALDATO	SUPPORT BOOMS LL1570 WELDED	SUPPORT DES BRAS LL1570 SOUDÉ	LL1570 GESCHWEISSTE HALTERUNG DER ÄRME	SOPORTE BRAZOS LL1570 SOLDADO
16	377429H1	SUPPORTO BRACCI	BOOM SUPPORT	SUPPORT BRAS	ÄRMEHALTERUNG	SOPORTE BRAZOS
16	377429J1	SUPPORTO BRACCI LL1570 SALDATO	SUPPORT BOOMS LL1570 WELDED	SUPPORT DES BRAS LL1570 SOUDÉ	LL1570 GESCHWEISSTE HALTERUNG DER ÄRME	SOPORTE BRAZOS LL1570 SOLDADO
16	377429J2	SUPPORTO BRACCI	BOOM SUPPORT	SUPPORT BRAS	ÄRMEHALTERUNG	SOPORTE BRAZOS
17	060372Y2	FERMO	RETAINER	ARRÊT	HALTERUNG	SUJETADOR
18	07754700	PERNO ATTACCO 1° BRACCIO A SUPPORTO BRACCI LL1570-X15JP-X430AJ	PIN CONNECTION 1ST ARM SUPPORT ARMS LL1570-X15JP-X430AJ	AXE	STIFT	CLAVIJA
19	07754800	PERNO ATTACCO TIRANTE 1°BRACCIO A SUPPORTO BRACCI LL1570-X15JP-X430AJ	PIN CONNECTION TIE 1ST ARM SUPPORT ARMS LL1570-X15JP- X430AJ	AXE	STIFT	CLAVIJA
20	071531D2	INDICE ALLINEAMENTO	ALIGNMENT INDICATOR	INDICATEUR D'ALIGNEMENT	AUSRICHTUNGSANZE IGE	INDICADOR ALINEACIÓN
21	05849000	PATTINO	SLIDE BLOCK	PATIN	GLEITBLOCK	PATÍN
22	07771600	TAMPONE APPOGGIO PRIMO BRACCIO LL1570	BUFFER FOR SUPPORT FIRST ARM LL1570	TAMPON	PUFFER	TAMPÓN
23	069590H3	PROTEZIONE	PROTECTION	PROTECTION	SCHUTZ	PROTECCIÓN



Main color codes:  J1 - JLG Cream,  J2 - JLG Orange,  C4 - Green

 PRIMO BRACCIO

 FIRST ARM

 PREMIER BRAS
ERSTER AUSLEGERARM PRIMO BRAZO 





POS	Codice	 Descrizione	 Description	 Designation	 Benennung	 Descripción
24	077717H3	STAFFA FISSAGGIO MICRO PRIMO BRACCIO	BRACKET MICRO FIRST BOOM	BRIDE	BÜGEL	BRIDA
25	068912Y1	PERNO	PIN	GOUJON	ZAPFEN	PERNIO
26	064422Y1	FERMO	RETAINER	ARRÊT	HALTEVORRICHTUNG	BLOQUE
27	07539800	SPINA	PIN	AXE	STIFT	CLAVIJA
28	077556H3	PIEGATO FISSAGGIO DISTRIBUTORE LL1570	BENT FITTING DISTRIBUTOR LL1570	SUPPORT	HALTERUNG	SOPORTE
29	077558H2	PIEGATO ANTERIORE SUPPORTO DISTRIBUTORE	BENT FRONT SUPPORT DISTRIBUTOR	SUPPORT	HALTERUNG	SOPORTE
30	077557H2	PIEGATO POSTERIORE SUPPORTO DISTRIBUTORE	BENT BACK SUPPORT DISTRIBUTOR	SUPPORT	HALTERUNG	SOPORTE
31	373142A3	CARTER DISTRIBUTORE BRACCI (FOR LL1775- X17JP-X500AJ MK2 FROM C170000893)	CARTER BOOM HYDRAULIC DISTRIBUTOR (FOR LL1775-X17JP-X500AJ MK2 FROM C170000893)	CARTER DISTRIBUTEUR (FOR LL1775-X17JP-X500AJ MK2 FROM C170000893)	CARTER HÄNDLER (FOR LL1775-X17JP- X500AJ MK2 FROM C170000893)	CARTER DISTRIBUIDOR (FOR LL1775-X17JP-X500AJ MK2 FROM C170000893)
31	373142H2	CARTER DISTRIBUTORE BRACCI (FOR LL1775- X17JP-X500AJ MK2 FROM C170000893)	PROTECTION BOOM HYDRAULIC DISTRIBUTOR (FOR LL1775-X17JP-X500AJ MK2 FROM C170000893)	PROTECTION DISTRIBUTEUR (FOR LL1775-X17JP-X500AJ MK2 FROM C170000893)	SCHUTZ VENTILBLOCK (FOR LL1775-X17JP-X500AJ MK2 FROM C170000893)	PROTECCION DISTRIBUIDOR (FOR LL1775-X17JP-X500AJ MK2 FROM C170000893)
32	073144A3	COPERCHIO (FOR LL1775-X17JP-X500AJ MK2 FROM C170000893)	COVER (FOR LL1775- X17JP-X500AJ MK2 FROM C170000893)	COUVERTURE (FOR LL1775-X17JP-X500AJ MK2 FROM C170000893)	ABDECKUNG (FOR LL1775-X17JP-X500AJ MK2 FROM C170000893)	CUBIERTA (FOR LL1775-X17JP-X500AJ MK2 FROM C170000893)



Main color codes:  J1 - JLG Cream,  J2 - JLG Orange,  C4 - Green

 PRIMO BRACCIO

 FIRST ARM

 PREMIER BRAS
ERSTER AUSLEGERARM PRIMO BRAZO 





POS	Codice	 Descrizione	 Description	 Designation	 Benennung	 Descripción
32	073144H2	COPERCHIO (FOR LL1775-X17JP-X500AJ MK2 FROM C170000893)	COVER (FOR LL1775-X17JP-X500AJ MK2 FROM C170000893)	COUVERTURE (FOR LL1775-X17JP-X500AJ MK2 FROM C170000893)	DECKUNG (FOR LL1775-X17JP-X500AJ MK2 FROM C170000893)	COBERTURA (FOR LL1775-X17JP-X500AJ MK2 FROM C170000893)
32	075059H2	COPERCHIO SENZA CHIAVE VERSIONE ANSI (FOR LL1775-X17JP-X500AJ MK2 FROM C170000893)	COVER WITHOUT KEY ANSI VERSION (FOR LL1775-X17JP-X500AJ MK2 FROM C170000893)	COUVERTURE SANS CLÉ (FOR LL1775-X17JP-X500AJ MK2 FROM C170000893)	DECKUNG OHNE SCHLÜSSEL (FOR LL1775-X17JP-X500AJ MK2 FROM C170000893)	COBERTURA SIN LLAVE (FOR LL1775-X17JP-X500AJ MK2 FROM C170000893)
33	07178800	SERRATURA	LOCK	SERRURE	SCHLOSS	CERRADURA
34	07298800	CHIAVE PER SERRATURA POSTAZIONE COMANDO A TERRA	KEY TO THE LOCK ON THE GROUND CONTROL POSITION	CLÉ	SCHLÜSSEL	LLAVE
35	07178900	CAMMA PER SERRATURA DISASSAMENTO 3.2	CAM LOCK FOR OFFSET 3.2	CAME	NOCKEN	LEVA
36	073138Y1	SUPPORTO SERRATURA	LOCK SUPPORT	SUPPORT SERRURE	SCHLOSSHALTERUNG	SOPORTE CERRADURA



Main color codes:  J1 - JLG Cream,  J2 - JLG Orange,  C4 - Green

 SECONDO BRACCIO

 SECOND ARM

 SECOND BRAS
ZWEITER AUSLEGERARM SEGUNDO BRAZO 





POS	Codice	 Descrizione	 Description	 Designation	 Benennung	 Descripción
1	177347A6	TIRANTE SECONDO BRACCIO LL1570 COMPLETO	TIE ROD COMPLETE SECOND BOOM LL1570	TIRANT DEUXIÈME BRAS	ZWEITER ARM TURMGESTÄNGE	TIRANTE SEGUNDO BRAZO
1	177347A7	TIRANTE SECONDO BRACCIO LL1570 COMPLETO	TIE ROD COMPLETE SECOND BOOM LL1570	TIRANT DEUXIÈME BRAS	ZWEITER ARM TURMGESTÄNGE	TIRANTE SEGUNDO BRAZO
1	177347A8	TIRANTE SECONDO BRACCIO LL1570 COMPLETO	TIE ROD COMPLETE SECOND BOOM LL1570	TIRANT DEUXIÈME BRAS	ZWEITER ARM TURMGESTÄNGE	TIRANTE SEGUNDO BRAZO
1	177347B1	TIRANTE SECONDO BRACCIO LL1570 COMPLETO	TIE ROD COMPLETE SECOND BOOM LL1570	TIRANT DEUXIÈME BRAS	ZWEITER ARM TURMGESTÄNGE	TIRANTE SEGUNDO BRAZO
1	177347B6	TIRANTE SECONDO BRACCIO LL1570 COMPLETO	TIE ROD COMPLETE SECOND BOOM LL1570	TIRANT DEUXIÈME BRAS	ZWEITER ARM TURMGESTÄNGE	TIRANTE SEGUNDO BRAZO
1	177347BP	TIRANTE SECONDO BRACCIO LL1570 COMPLETO	TIE ROD COMPLETE SECOND BOOM LL1570	TIRANT DEUXIÈME BRAS	ZWEITER ARM TURMGESTÄNGE	TIRANTE SEGUNDO BRAZO
1	177347BR	TIRANTE SECONDO BRACCIO LL1570 COMPLETO	TIE ROD COMPLETE SECOND BOOM LL1570	TIRANT DEUXIÈME BRAS	ZWEITER ARM TURMGESTÄNGE	TIRANTE SEGUNDO BRAZO
1	177347C4	TIRANTE SECONDO BRACCIO LL1570 COMPLETO	TIE ROD COMPLETE SECOND BOOM LL1570	TIRANT	TURMGESTÄNGE	TIRANTE
1	177347FX	TIRANTE SECONDO BRACCIO LL1570 COMPLETO	TIE ROD COMPLETE SECOND BOOM LL1570	TIRANT DEUXIÈME BRAS	ZWEITER ARM TURMGESTÄNGE	TIRANTE SEGUNDO BRAZO
1	177347GB	TIRANTE SECONDO BRACCIO LL1570 COMPLETO	TIE ROD COMPLETE SECOND BOOM LL1570	TIRANT DEUXIÈME BRAS	ZWEITER ARM TURMGESTÄNGE	TIRANTE SEGUNDO BRAZO
1	177347H1	TIRANTE SECONDO BRACCIO	SECOND TIE BOOM	TIRANT	TURMGESTÄNGE	TIRANTE



Main color codes:  J1 - JLG Cream,  J2 - JLG Orange,  C4 - Green

 SECONDO BRACCIO

 SECOND ARM

 SECOND BRAS
ZWEITER AUSLEGERARM SEGUNDO BRAZO 



POS	Codice	 Descrizione	 Description	 Designation	 Benennung	 Descripción
1	177347J1	TIRANTE SECONDO BRACCIO LL1570 COMPLETO	TIE ROD COMPLETE SECOND BOOM LL1570	TIRANT DEUXIÈME BRAS	ZWEITER ARM TURMGESTÄNGE	TIRANTE SEGUNDO BRAZO
1	177347J2	TIRANTE SECONDO BRACCIO	SECOND TIE BOOM	TIRANT	TURMGESTÄNGE	TIRANTE
2	07599600	BOCCOLA 25X30 L30 HSG	BUSH 25X30 L30 HSG	DOUILLE 25X30 L30 HSG	BUCHSE 25X30 L30 HSG	CASQUILLO 25X30 L30 HSG
3	07154000	MANIGLIA	HANDLE	POIGNÉE	GRIFF	MANIJA
4	177610A6	SECONDO BRACCIO LL1570 COMPLETO	SECOND BOOM COMPLETE LL1570	DEUMIÈME BRAS	ZWEITER ARM	SEGUNDO BRAZO
4	177610A7	SECONDO BRACCIO LL1570 COMPLETO	SECOND BOOM COMPLETE LL1570	DEUMIÈME BRAS	ZWEITER ARM	SEGUNDO BRAZO
4	177610A8	SECONDO BRACCIO LL1570 COMPLETO	SECOND BOOM COMPLETE LL1570	DEUMIÈME BRAS	ZWEITER ARM	SEGUNDO BRAZO
4	177610B1	SECONDO BRACCIO LL1570 COMPLETO	SECOND BOOM COMPLETE LL1570	DEUMIÈME BRAS	ZWEITER ARM	SEGUNDO BRAZO
4	177610B6	SECONDO BRACCIO LL1570 COMPLETO	SECOND BOOM COMPLETE LL1570	DEUMIÈME BRAS	ZWEITER ARM	SEGUNDO BRAZO
4	177610BP	SECONDO BRACCIO LL1570 COMPLETO	SECOND BOOM COMPLETE LL1570	DEUMIÈME BRAS	ZWEITER ARM	SEGUNDO BRAZO
4	177610BR	SECONDO BRACCIO LL1570 COMPLETO	SECOND BOOM COMPLETE LL1570	DEUMIÈME BRAS	ZWEITER ARM	SEGUNDO BRAZO
4	177610C4	SECONDO BRACCIO LL1570 COMPLETO	SECOND BOOM COMPLETE LL1570	DEUXIÈME BRAS	ZWEITER ARM	SEGUNDO BRAZO
4	177610FX	SECONDO BRACCIO LL1570 COMPLETO	SECOND BOOM COMPLETE LL1570	DEUMIÈME BRAS	ZWEITER ARM	SEGUNDO BRAZO
4	177610GB	SECONDO BRACCIO LL1570 COMPLETO	SECOND BOOM COMPLETE LL1570	DEUMIÈME BRAS	ZWEITER ARM	SEGUNDO BRAZO
4	177610H1	SECONDO BRACCIO COMPLETO	SECOND BOOM COMPLETE	DEUXIEME BRAS COMPLET	ZWEITER ARM KOMPLETT	SEGUNDO BRAZO COMPLETO
4	177610J1	SECONDO BRACCIO LL1570 COMPLETO	SECOND BOOM COMPLETE LL1570	DEUMIÈME BRAS	ZWEITER ARM	SEGUNDO BRAZO
4	177610J2	SECONDO BRACCIO COMPLETO	SECOND BOOM COMPLETE	DEUXIEME BRAS COMPLET	ZWEITER ARM KOMPLETT	SEGUNDO BRAZO COMPLETO



Main color codes:  J1 - JLG Cream,  J2 - JLG Orange,  C4 - Green

 SECONDO BRACCIO

 SECOND ARM

 SECOND BRAS
ZWEITER AUSLEGERARM SEGUNDO BRAZO 





POS	Codice	 Descrizione	 Description	 Designation	 Benennung	 Descripción
5	07765100	BOCCOLA DEVA.TEX552 354040	BUSH DEVA. TEX 552 354040	DOUILLE	BUCHSE	CASQUILLO
6	06586000	BOCCOLA	BUSH	BAGUE	BUCHSE	CASQUILLO
7	377352A6	RINVIO SECONDO- TERZO BRACCIO LL1570 SALDATO	REFERENCE SECOND- THIRD BOOM LL1570 WELDED	RENVOI DEUXIÈME BRAS	ZWEITER ARM VORGELEGE	REENVIO SEGUNDO BRAZO
7	377352A7	RINVIO SECONDO- TERZO BRACCIO LL1570 SALDATO	REFERENCE SECOND- THIRD BOOM LL1570 WELDED	RENVOI DEUXIÈME BRAS	ZWEITER ARM VORGELEGE	REENVIO SEGUNDO BRAZO
7	377352A8	RINVIO SECONDO- TERZO BRACCIO LL1570 SALDATO	REFERENCE SECOND- THIRD BOOM LL1570 WELDED	RENVOI DEUXIÈME BRAS	ZWEITER ARM VORGELEGE	REENVIO SEGUNDO BRAZO
7	377352B1	RINVIO SECONDO- TERZO BRACCIO LL1570 SALDATO	REFERENCE SECOND- THIRD BOOM LL1570 WELDED	RENVOI DEUXIÈME BRAS	ZWEITER ARM VORGELEGE	REENVIO SEGUNDO BRAZO
7	377352B6	RINVIO SECONDO- TERZO BRACCIO LL1570 SALDATO	REFERENCE SECOND- THIRD BOOM LL1570 WELDED	RENVOI DEUXIÈME BRAS	ZWEITER ARM VORGELEGE	REENVIO SEGUNDO BRAZO
7	377352BP	RINVIO SECONDO- TERZO BRACCIO LL1570 SALDATO	REFERENCE SECOND- THIRD BOOM LL1570 WELDED	RENVOI DEUXIÈME BRAS	ZWEITER ARM VORGELEGE	REENVIO SEGUNDO BRAZO
7	377352BR	RINVIO SECONDO- TERZO BRACCIO LL1570 SALDATO	REFERENCE SECOND- THIRD BOOM LL1570 WELDED	RENVOI DEUXIÈME BRAS	ZWEITER ARM VORGELEGE	REENVIO SEGUNDO BRAZO
7	377352C4	RINVIO SECONDO- TERZO BRACCIO LL1570 SALDATO	REFERENCE SECOND- THIRD BOOM LL1570 WELDED	RENVOI	VORGELEGE	REENVIO
7	377352FX	RINVIO SECONDO- TERZO BRACCIO LL1570 SALDATO	REFERENCE SECOND- THIRD BOOM LL1570 WELDED	RENVOI DEUXIÈME BRAS	ZWEITER ARM VORGELEGE	REENVIO SEGUNDO BRAZO
7	377352GB	RINVIO SECONDO- TERZO BRACCIO LL1570 SALDATO	REFERENCE SECOND- THIRD BOOM LL1570 WELDED	RENVOI DEUXIÈME BRAS	ZWEITER ARM VORGELEGE	REENVIO SEGUNDO BRAZO



Main color codes:  J1 - JLG Cream,  J2 - JLG Orange,  C4 - Green



 SECONDO BRACCIO



 SECOND ARM

 SECOND BRAS
ZWEITER AUSLEGERARM SEGUNDO BRAZO 



POS	Codice	 Descrizione	 Description	 Designation	 Benennung	 Descripción
7	377352H1	RINVIO SECONDO-TERZO BRACCIO	REFERENCE SECOND-THIRD BOOM	RENOI DEUXIEME-TROISIEME BRAS	VORGELEGE ZWEITER-DRITTER ARM	REENVIO SEGUNDO-TERZERO BRAZO
7	377352J1	RINVIO SECONDO-TERZO BRACCIO LL1570 SALDATO	REFERENCE SECOND-THIRD BOOM LL1570 WELDED	RENOI DEUXIÈME BRAS	ZWEITER ARM VORGELEGE	REENVIO SEGUNDO BRAZO
7	377352J2	RINVIO SECONDO-TERZO BRACCIO	REFERENCE SECOND-THIRD BOOM	RENOI DEUXIEME-TROISIEME BRAS	VORGELEGE ZWEITER-DRITTER ARM	REENVIO SEGUNDO-TERCERO BRAZO
9	07755300	PERNO ATTACCO TIRANTE 2°BRACCIO A RINVIO 2°3°BRACCIO LL1570-X15JP-X430AJ	PIN CONNECTION ROD 2ND ARM REFERENCE 2ND 3RD ARM LL1570-X15JP-X430AJ	AXE	STIFT	CLAVIJA
10	07271600	SPINA	PIN	CHEVILLE	STIF	CLAVIJA
11	07755100	PERNO ATTACCO TIRANTE 2°BRACCIO A RINVIO 1°2°BRACCIO LL1570-X15JP-X430AJ	PIN CONNECTION ROD 2ND ARM REFERENCE 1ST 2ND ARM LL1570-X15JP-X430AJ	AXE	STIFT	CLAVIJA
12	07093900	SPINA	PIN	CHEVILLE	STIF	CLAVIJA

Main color codes:  J1 - JLG Cream,  J2 - JLG Orange,  C4 - Green

-  TERZO BRACCIO
-  THIRD ARM
-  TIERS BRAS

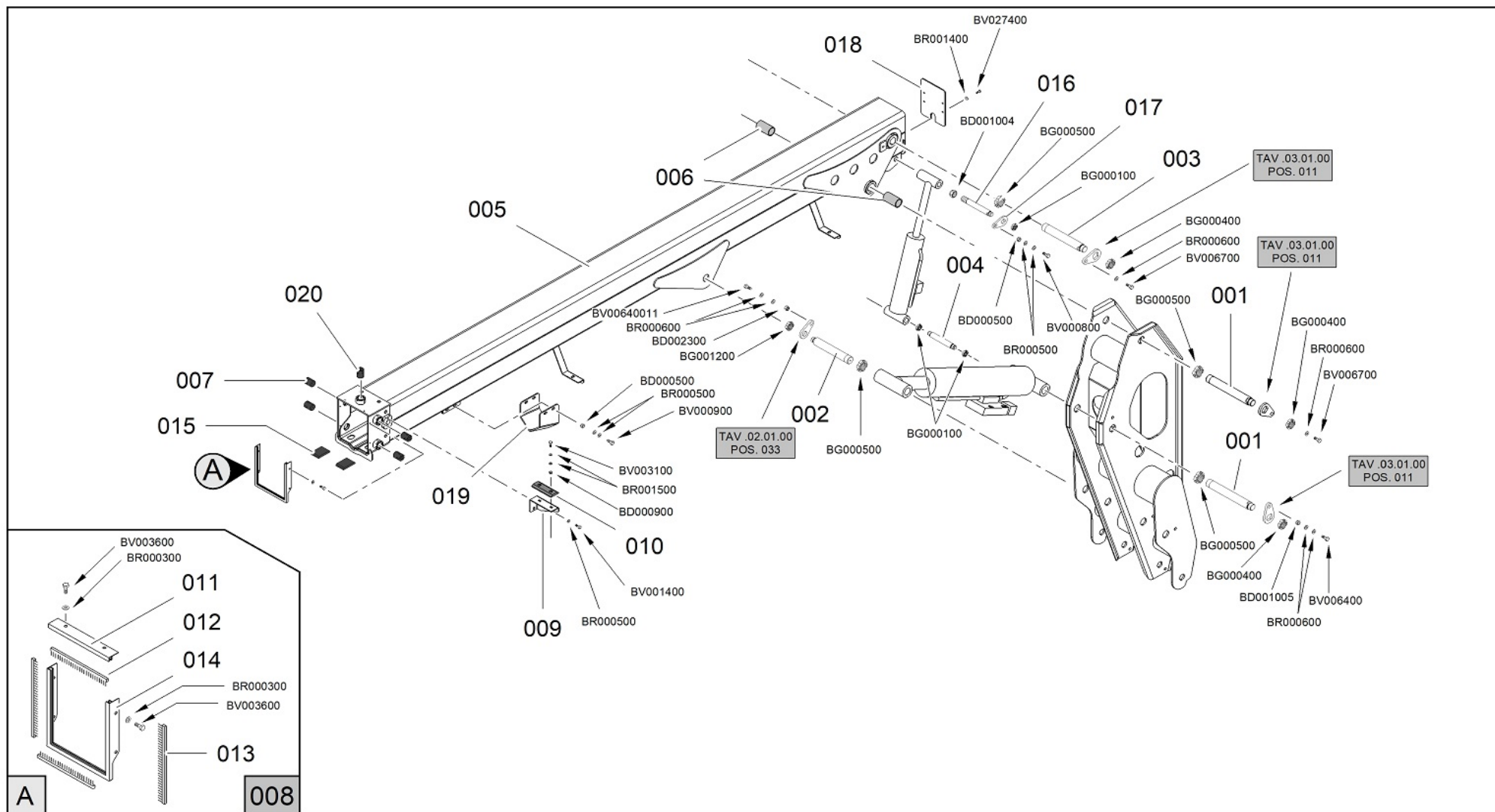
THIRD AUSLEGERARM 
 TERCERO BRAZO 











Main color codes:  J1 - JLG Cream,  J2 - JLG Orange,  C4 - Green

 TERZO BRACCIO

 THIRD ARM

 TIERS BRAS
THIRD AUSLEGERARM TERCERO BRAZO 

POS	Codice	 Descrizione	 Description	 Designation	 Benennung	 Descripción
1	07094900	SPINA	PIN	CHEVILLE	STIF	CLAVIJA
1	077380H3	PIEGATO CENTRAGGIO TERZO BRACCIO LL1570	BENDED CENTRING THIRD BOOM LL1570	SUPPORT	HALTERUNG	SOPORTE
2	06561000	SPINA	PIN	CHEVILLE	STIF	CLAVIJA
3	07102500	SPINA	PIN	CHEVILLE	STIF	CLAVIJA
4	06867600	SPINA	PIN	CHEVILLE	STIFT	CLAVIJA
5	177366A6	TERZO BRACCIO LL1570 COMPLETO	THIRD BOOM COMPLETE LL1570	TROISIÈME BRAS	DRITTER ARM	TERCERO BRAZO
5	177366A7	TERZO BRACCIO LL1570 COMPLETO	THIRD BOOM COMPLETE LL1570	TROISIÈME BRAS	DRITTER ARM	TERCERO BRAZO
5	177366A8	TERZO BRACCIO LL1570 COMPLETO	THIRD BOOM COMPLETE LL1570	TROISIÈME BRAS	DRITTER ARM	TERCERO BRAZO
5	177366B1	TERZO BRACCIO LL1570 COMPLETO	THIRD BOOM COMPLETE LL1570	TROISIÈME BRAS	DRITTER ARM	TERCERO BRAZO
5	177366B6	TERZO BRACCIO LL1570 COMPLETO	THIRD BOOM COMPLETE LL1570	TROISIÈME BRAS	DRITTER ARM	TERCERO BRAZO
5	177366BP	TERZO BRACCIO LL1570 COMPLETO	THIRD BOOM COMPLETE LL1570	TROISIÈME BRAS	DRITTER ARM	TERCERO BRAZO
5	177366BR	TERZO BRACCIO LL1570 COMPLETO	THIRD BOOM COMPLETE LL1570	TROISIÈME BRAS	DRITTER ARM	TERCERO BRAZO
5	177366C4	TERZO BRACCIO LL1570 COMPLETO	THIRD BOOM COMPLETE LL1570	TROISIÈME BRAS	DRITTER ARM	TERCERO BRAZO
5	177366FX	TERZO BRACCIO LL1570 COMPLETO	THIRD BOOM COMPLETE LL1570	TROISIÈME BRAS	DRITTER ARM	TERCERO BRAZO
5	177366GB	TERZO BRACCIO LL1570 COMPLETO	THIRD BOOM COMPLETE LL1570	TROISIÈME BRAS	DRITTER ARM	TERCERO BRAZO
5	177366H1	TERZO BRACCIO COMPLETO	THIRD BOOM COMPLETE	TROISIEME BRAS COMPLET	DRITTER ARM KOMPLETT	TERCERO BRAZO COMPLETO
5	177366J1	TERZO BRACCIO LL1570 COMPLETO	THIRD BOOM COMPLETE LL1570	TROISIÈME BRAS	DRITTER ARM	TERCERO BRAZO
5	177366J2	TERZO BRACCIO COMPLETO	THIRD BOOM COMPLETE	TROISIEME BRAS COMPLET	DRITTER ARM KOMPLETT	TERCERO BRAZO COMPLETO
6	06586000	BOCCOLA	BUSH	BAGUE	BUCHSE	CASQUILLO

Main color codes:  J1 - JLG Cream,  J2 - JLG Orange,  C4 - Green



 TERZO BRACCIO



 THIRD ARM

 TIERS BRAS

 THIRD AUSLEGERARM

 TERCERO BRAZO



POS	Codice	 Descrizione	 Description	 Designation	 Benennung	 Descripción
7	06958600	PATTINO	SLIDE BLOCK	PATIN	GLEITBLOCK	PATÍN
8	17767600	KIT SPAZZOLE TERZO BRACCIO LL2010	BRUSHES KIT	KIT BROSSES	BÜRSTENSATZ	KIT CEPILLOS
9	068663H3	SUPPORTO	SUPPORT	SUPPORT	HALTERUNG	SOPORTE
10	06867100	PATTINO	SLIDE BLOCK	PATIN	GLEITBLOCK	PATÍN
11	07101600	PROFILO SPAZZOLE SUPERIORE	PROFILE BRUSH TOP	CHÂSSIS	RAHMEN	BASTIDOR
12	07102000	SPAZZOLA ORRIZONTALE	HORIZONTAL BRUSH	BROSSE HORIZONTALE	WAAGRECHTE BÜRSTE	CEPILLO HORIZONTAL
13	07102100	SPAZZOLA VERTICALE	VERTICAL BRUSH	BROSSE VERTICALE	SENKRECHTE BÜRSTE	CEPILLO VERTICAL
14	07754300	PIEGATO FISSAGGIO SPAZZOLE	BENT FITTING BRUSHES	SUPPORT	HALTERUNG	SOPORTE
15	07754200	PATTINO APPOGGIO SFILO SU TERZO BRACCIO LL1570	SKID SUPPORT EXTENSION ON THIRD BOOM LL1570	PATIN	GLEITSCHUH	PATÍN
16	06230600	SPINA	PIN	CHEVILLE	STIFT	CLAVIJA
17	064965Y1	GOCCIA SPINA	PIN DROP	BAISSE CHEVILLE	TROPFEN	CAÍDA CLAVIJA
18	077536H3	CARTER POSTERIORE TERZO BRACCIO	CARTER BACK THIRD BOOM	CARTER	KURBELGEHÄUSE	CÁRTER
19	077380A6	PIEGATO CENTRAGGIO TERZO BRACCIO LL1570	BENDED CENTRING THIRD BOOM LL1570	SUPPORT	HALTERUNG	SOPORTE
19	077380H3	PIEGATO CENTRAGGIO TERZO BRACCIO LL1570	BENDED CENTRING THIRD BOOM LL1570	SUPPORT	HALTERUNG	SOPORTE
20	05804700	PATTINO	SLIDE BLOCK	PATIN	GLEITBLOCK	PATÍN





Main color codes:  J1 - JLG Cream,  J2 - JLG Orange,  C4 - Green



 CATENA PORTACAVI FLESSIBILE

 FLEXIBLE CABLE-HOLDER CHAIN

 CHAÎNE PORTE-CABLES FLEXIBLE

 SCHLAUCH SCHLEPPKETTE 
 CADENA PORTACABLES FLEXIBLE 



POS	Codice	 Descrizione	 Description	 Designation	 Benennung	 Descripción
1	177104A6	BRACCIO SFILO LL1570 COMPLETO	COMPLETE BOOM EXTENSION	BRAS D'EXTENSION	TELESKOP ARM	BRAZO TELESCÓPICO
1	177104A7	BRACCIO SFILO LL1570 COMPLETO	COMPLETE BOOM EXTENSION	BRAS D'EXTENSION	TELESKOP ARM	BRAZO TELESCÓPICO
1	177104A8	BRACCIO SFILO LL1570 COMPLETO	COMPLETE BOOM EXTENSION	BRAS D'EXTRACTION	AUSLEGER ARM	BRAZO DE EXTENSIÓN
1	177104B1	BRACCIO SFILO LL1570 COMPLETO	COMPLETE BOOM EXTENSION	BRAS D'EXTRACTION	AUSLEGER ARM	BRAZO DE EXTENSIÓN
1	177104BP	BRACCIO SFILO LL1570 COMPLETO	COMPLETE BOOM EXTENSION	BRAS D'EXTRACTION	AUSLEGER ARM	BRAZO DE EXTENSIÓN
1	177104BR	BRACCIO SFILO LL1570 COMPLETO	COMPLETE BOOM EXTENSION	BRAS D'EXTRACTION	AUSLEGER ARM	BRAZO DE EXTENSIÓN
1	177104C4	BRACCIO SFILO LL1570 COMPLETO	COMPLETE BOOM EXTENSION	BRAS D'EXTENSION	TELESKOPARM	BRAZO DE EXTENSIÓN
1	177104CD	BRACCIO SFILO LL1570 COMPLETO	COMPLETE BOOM EXTENSION	BRAS D'EXTENSION	ARMVERLÄNGERUNG	BRAZO DE EXTENSIÓN
1	177104FX	BRACCIO SFILO LL1570 COMPLETO	COMPLETE BOOM EXTENSION	BRAS D'EXTENSION	ARMVERLÄNGERUNG	BRAZO DE EXTENSIÓN
1	177104GB	BRACCIO SFILO LL1570 COMPLETO	COMPLETE BOOM EXTENSION	BRAS D'EXTRACTION	AUSLEGER ARM	BRAZO DE EXTENSIÓN
1	177104H1	BRACCIO SFILO COMPLETO	COMPLETE EXTENSION BOOM	BRAS D'EXTENSION	ARMVERLÄNGERUNG	BRAZO TELESCÓPICO
1	177104J2	BRACCIO SFILO LL1570 COMPLETO	COMPLETE BOOM EXTENSION	BRAS D'EXTENSION	ARMVERLÄNGERUNG	BRAZO DE EXTENSIÓN
2	377362H3	ASSIEME SUPPORTO CATENARIA SFILO LL1570 SALDATO	ASSEMBLY SUPPORT CONTACT LINE EXTENSION LL1570 WELDED	SUPPORT	HALTERUNG	SOPORTE
3	07767500	PATTINO GUIDA CILINDRO SFILO LL1570	SKID GUIDE CYLINDER EXTENSION LL1570	PATIN	GLEITSCHUH	PATÍN
4	07765800	BOCCOLA DEVA.TEX552 202815	BUSH DEVA.TEX 552 202815	DOUILLE	BUCHSE	CASQUILLO
5	07178200	PATTINO	SLIDE BLOCK	PATIN	GLEITBLOCK	PATÍN





 Main color codes:  J1 - JLG Cream,  J2 - JLG Orange,  C4 - Green



 CATENA PORTACAVI FLESSIBILE



 FLEXIBLE CABLE-HOLDER CHAIN

 CHAÎNE PORTE-CABLES FLEXIBLE



 SCHLAUCH SCHLEPPKETTE 
 CADENA PORTACABLES FLEXIBLE 

POS	Codice	 Descrizione	 Description	 Designation	 Benennung	 Descripción
6	07711300	PATTINO	SLIDE BLOCK	PATIN	GLEITBLOCK	PATÍN
7	06853800	SPINA	PIN	CHEVILLE	STIF	CLAVIJA
8	07530500	MORSETTO FERMA TUBI	CLAMP	ÉTAU	KLEMME	ABRAZADERA
9	077534H3	PIEGATO SUPPORTO CATENARIA SFILO LL1570	BENDED WIRE SUPPORT CATENARY LL1570	SUPPORT	HALTERUNG	SOPORTE
10	071314H3	COPERCHIO ANTERIORE SFILO	FRONT COVER EXTENSION	COUVERCLE	DECKEL	TAPA
11	27766400	CATENA PORTACAVI	CABLE-HOLDER CHAIN	CHAÎNE PORTE-CÂBLES	KABELHALTERKETTE	CADENA PORTACABLES
12	2595050004	COPERCHIO	COVER	COUVERCLE	DECKEL	TAPA
13	2595050001	MAGLIA CATENA ATTACCO FEMMINA	CHAIN LINK FEMALE CONNECTION	MAILLOT CHAÎNE	KETTENGLIED	ESLABÓN CADENA
14	2595050002	MAGLIA CATENA ATTACCO MASCHIO	CHAIN LINK MALE CONNECTION	MAILLOT CHAÎNE	KETTENGLIED	ESLABÓN CADENA
15	2595050003	MAGLIA CATENA	CHAIN LINK	MAILLOT CHAÎNE	KETTENGLIED	ESLABÓN CADENA
16	072263H3	STAFFA	BRACKET	ÉTRIER	HALTEBÜGEL	ESTRIBO
17	04096600	PIASTRA	CLAMP	BRIDE	KLEMME	PLACA
18	04096800	MORSETTO	CLAMP	BRIDE	KLEMME	BORNE

-  SUPPORTO CESTO
-  BASKET SUPPORT
-  PANIER CUPPORT

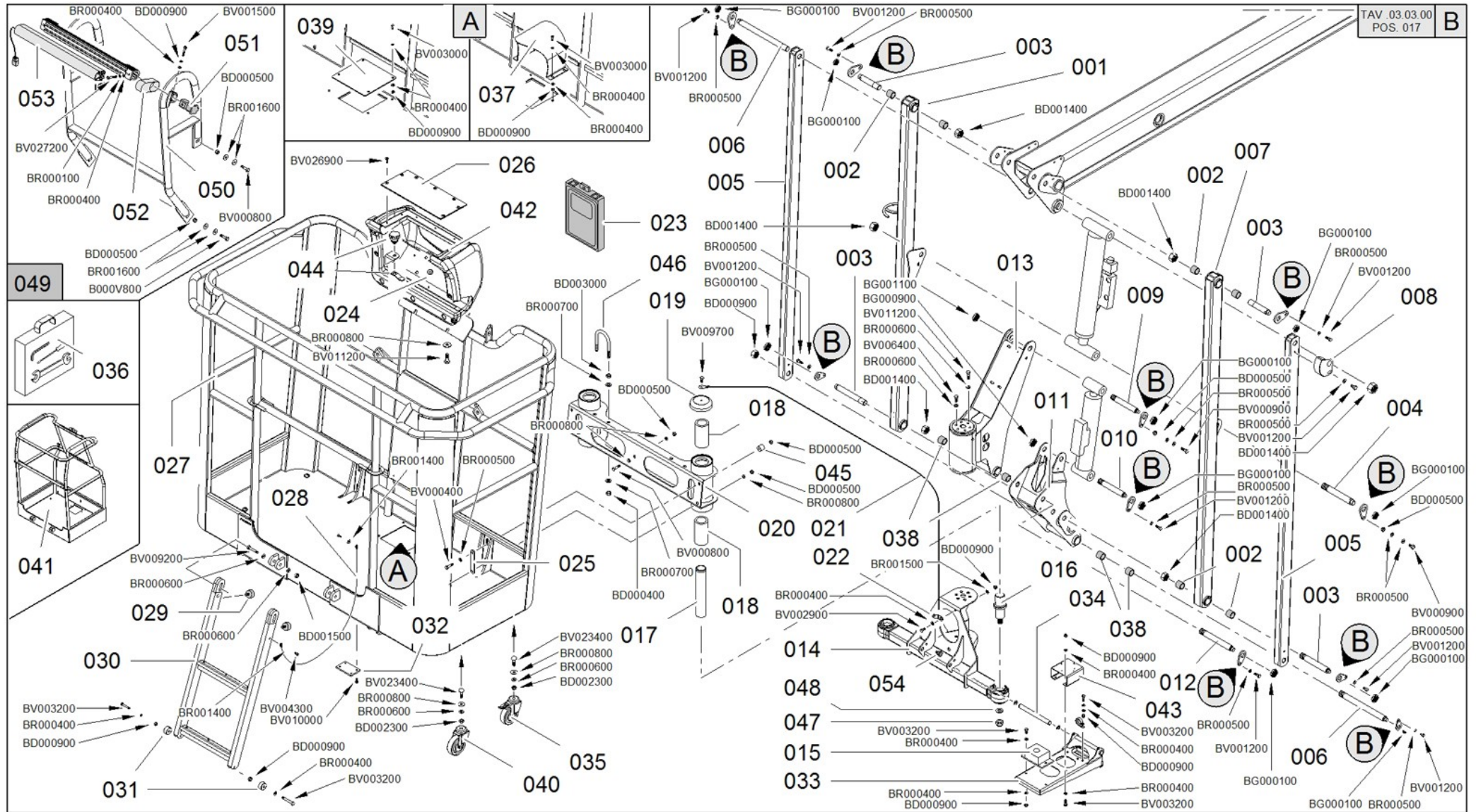
HALTERUNG ARBEITSKORB 
 SOPORTE CESTA 











Main color codes:  J1 - JLG Cream,  J2 - JLG Orange,  C4 - Green

 SUPPORTO CESTO

 BASKET SUPPORT

 PANIER CUPPORT
HALTERUNG ARBEITSKORB SOPORTE CESTA 





POS	Codice	 Descrizione	 Description	 Designation	 Benennung	 Descripción
1	177718A6	ASSIEME BRACCIO JIB DESTRO COMPLETO	ASSEMBLY BOOM JIB RIGHT COMPLETE	BRAS JIB DROIT	RECHTER JIB ARM	BRAZO JIB DERECHO
1	177718A7	ASSIEME BRACCIO JIB DESTRO COMPLETO	ASSEMBLY BOOM JIB RIGHT COMPLETE	BRAS JIB DROIT	RECHTER JIB ARM	BRAZO JIB DERECHO
1	177718A8	ASSIEME BRACCIO JIB DESTRO COMPLETO	ASSEMBLY BOOM JIB RIGHT COMPLETE	BRAS JIB DROIT	RECHTER JIB ARM	BRAZO JIB DERECHO
1	177718B1	ASSIEME BRACCIO JIB DESTRO COMPLETO	ASSEMBLY BOOM JIB RIGHT COMPLETE	BRAS JIB DROIT	RECHTER JIB ARM	BRAZO JIB DERECHO
1	177718BP	ASSIEME BRACCIO JIB DESTRO COMPLETO	ASSEMBLY BOOM JIB RIGHT COMPLETE	BRAS JIB DROIT	RECHTER JIB ARM	BRAZO JIB DERECHO
1	177718BR	ASSIEME BRACCIO JIB DESTRO COMPLETO	ASSEMBLY BOOM JIB RIGHT COMPLETE	BRAS JIB DROIT	RECHTER JIB ARM	BRAZO JIB DERECHO
1	177718C4	ASSIEME BRACCIO JIB DESTRO COMPLETO	ASSEMBLY BOOM JIB RIGHT COMPLETE	BRAS JIB	JIB ARM	BRAZO JIB
1	177718CD	ASSIEME BRACCIO JIB DESTRO COMPLETO	ASSEMBLY BOOM JIB RIGHT COMPLETE	BRAS JIB DROIT	RECHTER JIB ARM	BRAZO JIB DERECHO
1	177718FX	ASSIEME BRACCIO JIB DESTRO COMPLETO	ASSEMBLY BOOM JIB RIGHT COMPLETE	BRAS JIB DROIT	RECHTER JIB ARM	BRAZO JIB DERECHO
1	177718GB	ASSIEME BRACCIO JIB DESTRO COMPLETO	ASSEMBLY BOOM JIB RIGHT COMPLETE	BRAS JIB DROIT	RECHTER JIB ARM	BRAZO JIB DERECHO
1	177718H1	ASSIEME BRACCIO JIB DESTRO COMPLETO	ASSEMBLY BOOM JIB RIGHT COMPLETE	BRAS JIB DROIT COMPLET	RECHTER JIB ARM KOMPLETT	BRAZO JIB DERECHO COMPLETO



Main color codes:  J1 - JLG Cream,  J2 - JLG Orange,  C4 - Green

 SUPPORTO CESTO

 BASKET SUPPORT

 PANIER CUPPORT
HALTERUNG ARBEITSKORB SOPORTE CESTA 



POS	Codice	 Descrizione	 Description	 Designation	 Benennung	 Descripción
1	177718J2	ASSIEME BRACCIO JIB DESTRO COMPLETO	ASSEMBLY BOOM JIB RIGHT COMPLETE	BRAS JIB DROIT	RECHTER JIB ARM	BRAZO JIB DERECHO
2	07765600	BOCCOLA DEVA.TEX552 202820	BUSH DEVA.TEX 552 202820	DOUILLE	BUCHSE	CASQUILLO
3	07093500	SPINA	PIN	CHEVILLE	STIFT	CLAVIJA
4	07093800	SPINA	PIN	CHEVILLE	STIFT	CLAVIJA
5	359447A6	TIRANTE	TIE ROD	TIRANT	TURMGESTÄNGE	TIRANTE
5	359447A7	TIRANTE	TIE ROD	TIRANT	TURMGESTÄNGE	TIRANTE
5	359447A8	TIRANTE	TIE ROD	TIRANT	TURMGESTÄNGE	TIRANTE
5	359447B1	TIRANTE	TIE ROD	TIRANT	TURMGESTÄNGE	TIRANTE
5	359447BP	TIRANTE	TIE ROD	TIRANT	TURMGESTÄNGE	TIRANTE
5	359447BR	TIRANTE	TIE ROD	TIRANT	TURMGESTÄNGE	TIRANTE
5	359447C4	TIRANTE	TIE ROD	TIRANT	TURMGESTÄNGE	TIRANTE
5	359447CD	TIRANTE	TIE ROD	TIRANT	TURMGESTÄNGE	TIRANTE
5	359447FX	TIRANTE	TIE ROD	TIRANT	TURMGESTÄNGE	TIRANTE
5	359447GB	TIRANTE	TIE ROD	TIRANT	TURMGESTÄNGE	TIRANTE
5	359447H1	TIRANTE	TIE ROD	TIRANT	TURMGESTÄNGE	TIRANTE
5	359447J2	TIRANTE JIB	TIE ROD JIB	TIRANT	ZUGSTANGE	TIRANTE
6	07093600	SPINA	PIN	CHEVILLE	STIFT	CLAVIJA
7	177719A6	ASSIEME BRACCIO JIB SINISTRO COMPLETO	ASSEMBLY BOOM JIB LEFT COMPLETE	BRAS JIB GAUCHE	LINKER JIB ARM	BRAZO JIB IZQUIERDO
7	177719A7	ASSIEME BRACCIO JIB SINISTRO COMPLETO	ASSEMBLY BOOM JIB LEFT COMPLETE	BRAS JIB GAUCHE	LINKER JIB ARM	BRAZO JIB IZQUIERDO
7	177719A8	ASSIEME BRACCIO JIB SINISTRO COMPLETO	ASSEMBLY BOOM JIB LEFT COMPLETE	BRAS JIB GAUCHE	LINKER JIB ARM	BRAZO JIB IZQUIERDO
7	177719B1	ASSIEME BRACCIO JIB SINISTRO COMPLETO	ASSEMBLY BOOM JIB LEFT COMPLETE	BRAS JIB GAUCHE	LINKER JIB ARM	BRAZO JIB IZQUIERDO



Main color codes:  J1 - JLG Cream,  J2 - JLG Orange,  C4 - Green

 SUPPORTO CESTO

 BASKET SUPPORT

 PANIER CUPPORT
HALTERUNG ARBEITSKORB SOPORTE CESTA 





POS	Codice	 Descrizione	 Description	 Designation	 Benennung	 Descripción
7	177719BP	ASSIEME BRACCIO JIB SINISTRO COMPLETO	ASSEMBLY BOOM JIB LEFT COMPLETE	BRAS JIB GAUCHE	LINKER JIB ARM	BRAZO JIB IZQUIERDO
7	177719BR	ASSIEME BRACCIO JIB SINISTRO COMPLETO	ASSEMBLY BOOM JIB LEFT COMPLETE	BRAS JIB GAUCHE	LINKER JIB ARM	BRAZO JIB IZQUIERDO
7	177719C4	ASSIEME BRACCIO JIB SINISTRO COMPLETO	ASSEMBLY BOOM JIB LEFT COMPLETE	BRAS JIB	JIB ARM	BRAZO JIB
7	177719CD	ASSIEME BRACCIO JIB SINISTRO COMPLETO	ASSEMBLY BOOM JIB LEFT COMPLETE	BRAS JIB GAUCHE	LINKER JIB ARM	BRAZO JIB IZQUIERDO
7	177719FX	ASSIEME BRACCIO JIB SINISTRO COMPLETO	ASSEMBLY BOOM JIB LEFT COMPLETE	BRAS JIB GAUCHE	LINKER JIB ARM	BRAZO JIB IZQUIERDO
7	177719GB	ASSIEME BRACCIO JIB SINISTRO COMPLETO	ASSEMBLY BOOM JIB LEFT COMPLETE	BRAS JIB GAUCHE	LINKER JIB ARM	BRAZO JIB IZQUIERDO
7	177719H1	ASSIEME BRACCIO JIB SINISTRO COMPLETO	ASSEMBLY BOOM JIB LEFT COMPLETE	BRAS JIB GAUCHE COMPLET	RECHTER JIB ARM KOMPLETT	BRAZO JIB IZQUIERDO COMPLETO
7	177719J2	ASSIEME BRACCIO JIB SINISTRO COMPLETO	ASSEMBLY BOOM JIB LEFT COMPLETE	BRAS JIB GAUCHE	LINKER JIB ARM	BRAZO JIB IZQUIERDO
8	377713H3	CAMMA MICRO JIB	MICROSWITCH CAM JIB	CAME	NOCKEN	LEVA
9	07093700	SPINA	PIN	CHEVILLE	STIFT	CLAVIJA
10	06235600	SPINA	PIN	CHEVILLE	STIFT	CLAVIJA
11	175401A6	RINVIO JIB	UPRIGHT JIB	RENVOI	VORGELEGE	REENVIO
11	175401A7	RINVIO JIB	UPRIGHT JIB	RENVOI	VORGELEGE	REENVIO
11	175401A8	RINVIO JIB	UPRIGHT JIB	RENVOI	VORGELEGE	REENVIO
11	175401B1	RINVIO JIB	UPRIGHT JIB	RENVOI	VORGELEGE	REENVIO
11	175401BP	RINVIO JIB	UPRIGHT JIB	RENVOI	VORGELEGE	REENVIO
11	175401BR	RINVIO JIB	UPRIGHT JIB	RENVOI	VORGELEGE	REENVIO



Main color codes:  J1 - JLG Cream,  J2 - JLG Orange,  C4 - Green

 SUPPORTO CESTO

 BASKET SUPPORT

 PANIER CUPPORT
HALTERUNG ARBEITSKORB SOPORTE CESTA 





POS	Codice	 Descrizione	 Description	 Designation	 Benennung	 Descripción
11	175401C4	RINVIO JIB	UPRIGHT JIB	RENVOI	VORGELEGE	REENVIO
11	175401CD	RINVIO JIB	JIB CONNECTION ROD	RENVOI	VORGELEGE	REENVIO
11	175401FX	RINVIO JIB	JIB CONNECTION ROD	RENVOI	VORGELEGE	REENVIO
11	175401GB	RINVIO JIB	UPRIGHT JIB	RENVOI	VORGELEGE	REENVIO
11	175401H1	RINVIO JIB	UPRIGHT JIB	RENVOI	VORGELEGE	REENVIO
11	175401J2	RINVIO JIB	JIB CONNECTION ROD	RENVOI	VORGELEGE	REENVIO
12	06235700	SPINA	PIN	CHEVILLE	STIFT	CLAVIJA
13	2648910002	KIT GUARNIZIONI	SEAL KIT	KIT DE JOINTS	DICHTUNGSSATZ	KIT DE JUNTAS
13	271778A6	ATTUATORE ROTANTE	ROTARY MOTOR	ROTARY ACTUATOR	SCHWENKEINHEIT	ACTUADOR ROTATIVO
13	271778H2	MOTORE DI ROTAZIONE	ROTARY MOTOR	MOTEUR DE ROTATION	DREHANTRIEB	MOTOR ROTACIÓN
14	377660A6	SUPPORTO CESTO	BASKET SUPPORT	SUPPORT PANIER	KORBHALTERUNG	SOPORTE CESTA
14	377660H2	SUPPORTO CESTO	BASKET SUPPORT	SUPPORT PANIER	KORBHALTERUNG	SOPORTE CESTA
15	056187H3	COPERCHIO	BOX	COUVERCLE	DECKEL	TAPA
16	07190900	VITE TE DIN960 CI 8.8 M16X1.5X115 FORATA GEOMET321 PLUS XL	TE SCREW DIN960 CI 8.8 M16X1.5X115 GEOMET321 PERFORATED PLUS XL	VIS TE DIN960 CI 8,8 M16X1.5X115 FORE PLUS GEOMET321 XL	TE SCHRAUBE DIN960 CI 8,8 M16X1.5X115 GEOMET321 PERFORATED PLUS XL	TE TORNILLO DIN960 CI 8,8 M16X1.5X115 GEOMET321 PERFORADA XL
17	07146500	PERNO SUPPORTO CESTO DIAM.50	PIN SUPPORT BASKET Ø50	AXE DIAM.50 PANIER DE SOUTIEN	BOLZEN KORBHALTERUNG	CLAVIJA CESTA
18	27146200	CUSCINETTO LINEARE A SFERE 50-100	LINEAR BALL BEARING 50-100	ROULEMENT Á BILLES	LINEAR-KUGELLAGER 50-100	COJINETE DE BOLAS 50-100
19	07146400	TAPPO CHIUSURA PERNI SUPPORTO CESTO DIAM.50	CAP PINS BASKET SUPPORT Ø50	BOUCHON	VERSCHLUSS	TAPÓN
20	371459A6	SLITTA FISSAGGIO CESTO PERNI DIAM.50	SLIDE BASKET MOUNTING BOLTS Ø50	GRILLE COULISSANTE MONTAGE	SLIDE RACKMONTAGE	PARRILLA CORREDIZA MONTAJE
20	371459H2	SLITTA FISSAGGIO CESTO PERNI DIAM.50	SLIDE BASKET MOUNTING BOLTS Ø50	COULISSEAU	SCHLITTEN	CORREDERA



Main color codes:  J1 - JLG Cream,  J2 - JLG Orange,  C4 - Green

 SUPPORTO CESTO

 BASKET SUPPORT

 PANIER CUPPORT
HALTERUNG ARBEITSKORB SOPORTE CESTA 





POS	Codice	 Descrizione	 Description	 Designation	 Benennung	 Descripción
21	06665000	FUNE	CABLE	CÂBLE	SEIL	CABLE
22	058600H3	PIASTRA	PLATE	PLAQUE	PLATTE	PLACA
22	07052900	STAFFA	BRACKET	ÉTRIER	HALTEBÜGEL	ESTRIBO
23	05643600	CASSETTA PORTAMANUALE	MANUAL BOX	BOÎTE PORTE- MANUEL	BEDIENUNGSANLEIT- UNGSFACH	CAJA PORTAMANUAL
24	06477600	MAGNETE Ø20 CON FORO M3	MAGNETO Ø20 WITH M3 HOLE	AIMANT	MAGNET	IMÁN
25	072398H3	PIASTRA FISSAGGIO CESTO (SOLO MACCHINE MODELLO JP E JA E X17J)	FIXING PLATE BASKET (ONLY MACHINES MODEL JP AND JA AND X17J)	PLATE FIXATION DRUM	PLATE BEFESTIGUNG DRUM	PLACA FIJACIÓN TAMBOR
26	07690700	PROTEZIONE TRASPARENTE	PROTECTION	PROTECTION	SCHUTZ	PROTECCIÓN
27	17716900	CESTO MONOPOSTO COMPLETO PER X26JP	BASKET COMPLETE SINGLE PERSON X26JP	PANIER UNE PERSONNE	EIN-MANN KORB	CESTA PARA 1 PERSONA
27	27589300	CESTO BIPOSTO 230KG PER MK2 (DA C170000893)	BASKET 2 PERSON 230KG FOR MK2 (FROM C170000893)	PANIER 2 PERSONNES POUR MK2 (FROM C170000893)	2 MANN- ARBEITSKORB FÜR MK2 (FROM C170000893)	CESTA 2 PERSONAS PARA MK2 (FROM C170000893)
27	28250000	CESTO	BASKET	PANIER POUR 2 PERSONNES	2-MANN- ARBEITSKORB	CESTA PARA DOS PERSONAS
28	06598500	FUNE	CABLE	CÂBLE	SEIL	CABLE
29	05475900	ANTIVIBRANTE	DAMPING	ANTI - VIBRANT	VIBRATIONSDÄMPFE R	ANTIVIBRANTE
30	36585800	SCALETTA	LADDER	ÉCHELLE	LEITER	ESCALERA
31	06585900	ROTELLINA	SMALL ROLLER	ROULETTE	RÄDCHEN	RUEDECILLA
32	058600H3	PIASTRA	PLATE	PLAQUE	PLATTE	PLACA
33	377661A6	MENSOLA SUPPORTO CELLA DI CARICO	BRACKET SUPPORT LOAD CELL	BRIDE SUPPORT CELLULE DE CHARGE	STEIGBÜGELHALTER- UNG FÜRLASTÜBERWACH- UNGSZELLE	BRIDA SOPORTE CELULA DE CARGA



Main color codes:  J1 - JLG Cream,  J2 - JLG Orange,  C4 - Green

 SUPPORTO CESTO

 BASKET SUPPORT

 PANIER CUPPORT
HALTERUNG ARBEITSKORB SOPORTE CESTA 

POS	Codice	 Descrizione	 Description	 Designation	 Benennung	 Descripción
33	377661H2	MENSOLA SUPPORTO CELLA DI CARICO	BRACKET SUPPORT LOAD CELL	BRIDE SUPPORT CELLULE DE CHARGE	STEIGBÜGELHALTER UNG FÜRLASTÜBERWACH UNGSZELLE	BRIDA SOPORTE CELULA DE CARGA
34	07766500	PERNO INCERNIERAMENTO MENSOLA SUPPORTO CESTO	PIN HINGE BRACKET SUPPORT BASKET	AXE	STIFT	PERNIO
35	07751100	RUOTE INFERIORI PER CESTO CON FRENO	LOWER WHEELS FOR BASKET WITH BRAKE	ROUES POUR PANIER	KORBRÄDER	RUEDAS
37	06418600	PROTEZIONE	PROTECTION	PROTECTION	SCHUTZ	PROTECCIÓN
38	06272700	BOCCOLA	BUSH	DOUILLE	BUCHSE	CASQUILLO
40	07687300	RUOTE INFERIORI PER CESTO	LOWER WHEEL	ROULEAU INFERIEUR	UNTERES RAD	RUEDA INFERIOR
41	28372000	CESTO MONOPOSTO LL2614 SKYLINE - NON PREDISPOSTO SKY GUARD	BASKET SINGLE SEAT LL2614 SKYLINE	PANIER MONOPLACE LL2614 SKYLINE	KORB EINZELSITZ LL2614 SKYLINE	CESTO MONOPLAZA LL2614 SKYLINE
42	17569900	PROTEZIONE TELECOMANDO	PROTECTION REMOTE CONTROL	PROTECTION	SCHUTZ	PROTECCIÓN
43	072404H3	SUPPORTO PEDALE	PEDAL SUPPORT PLATE	TÔLE PLIÉE	HALTERUNG	SOPORTE
44	07192700	CHIUSURA A VOLANTINO CON LEVA PIEGATA (SOLO MACCHINE MODELLO JP E JA E X17J)	LOCKING WHEEL WITH BENT LEVER (ONLY MACHINES MODEL JP AND JA AND X17J)	POIGNEE DE BLOCAGE	KUGELVERSCHLUSS	POMO DE BLOQUEO
45	07239700	DISTANZIALE PER VITI M8 SUPPORTO CESTO (SOLO MACCHINE MODELLO JP E JA E X17J)	SPACER SCREW M8 SUPPORT BASKET (ONLY MACHINES MODEL JP AND JA AND X17J)	ENTRETOISE	DISTANZSTÜCK	DISTANCIADOR
46	07031800	TUBO	PIPE	TUYAU	ROHR	TUBO

Main color codes:  J1 - JLG Cream,  J2 - JLG Orange,  C4 - Green

 SUPPORTO CESTO

 BASKET SUPPORT





 PANIER CUPPORT
HALTERUNG ARBEITSKORB SOPORTE CESTA 



POS	Codice	 Descrizione	 Description	 Designation	 Benennung	 Descripción
47	07193000	DADO AD INTAGLI UNI5593 CI 8 M16X1.5 GEOMET321 PLUS XL	NUT M16X1.5 NOTCHES UNI5593 CI 8 GEOMET321 PLUS XL	ÉCROU UNI5593 CI 8 M16X1.5 GEOMET321 PLUS XL	MUTTER UNI5593 CI 8 M16X1.5 GEOMET321 PLUS XL	TUERCA UNI5593 CI 8 M16X1.5 GEOMET321 PLUS XL
48	07192600	RONDELLA SPECIALE HV 300 - D 17X48X6 GEOMET321/A+PLUS XL	SPECIAL WASHER HV 300 - 17X48X6 GEOMET321 D / A + PLUS XL	RONDELLE SPECIALE HV 300 - 17X48X6 GEOMET321 D / A + PLUS XL	SCHEIBE HV 300 - 17X48X6 GEOMET321 D / A + PLUS XL	ARANDELA ESPECIAL HV 300 - 17X48X6 GEOMET321 D / A + PLUS XL
49	17768100	KIT SKY GUARD COMPLETO BIPOSTO PER CCBS	SKYGUARD COMPLETE KIT FOR 2 PERSON CCBS	KIT SKY GUARD	SKY GUARD SATZ	KIT SKY GUARD
49	17768300	KIT SKY GUARD COMPLETO MONOPOSTO PER CCBS	SKYGUARD COMPLETE KIT FOR SINGLE PERSON CCBS	KIT SKY GUARD	SATZ SKY GUARD	KIT SKY GUARD
50	08309700	DISTANZIALE	SPACER	ÉPAISSEUR	DISTANZSTÜCK	ESPACIADOR
50	37609800	TELAIO SUPPORTO SKY-GUARD CESTO BIPOSTO	SKY-FRAME SUPPORT GUARD BASKET 2PERSON	CHÂSSIS	RAHMEN	CHASIS
50	37675400	TELAIO SUPPORTO SKY-GUARD CESTO MONOPOSTO	SKY-FRAME SUPPORT GUARD BASKET 1PERSON	CHÂSSIS SUPPORT	RAHMEN HALTERUNG	BASTIDOR SOPORTE
50	38302200	SUPPORTO DESTRO	SUPPORT	SUPPORT	HALTERUNG	SOPORTE
50	38302300	SUPPORTO SINISTRO	SUPPORT	SUPPORT	HALTERUNG	SOPORTE
51	07796900	BLOCCHETTO PLASTICA PER FISSAGGIO SKYGUARD (1001188889)	BLOCK PLASTIC FOR SECURING SKYGUARD (1001188889)	BLOC	BLOCK	BLOQUE
52	07797000	COVER IN GOMMA PER PROTEZIONE FISSAGGIO SKY GUARD (1001186517)	COVER RUBBER PROTECTION FOR FIXING SKY GUARD (1001186517)	PROTECTION	SCHUTZ	PROTECCIÓN



 SUPPORTO CESTO

 BASKET SUPPORT

 PANIER CUPPORT
HALTERUNG ARBEITSKORB SOPORTE CESTA 

POS	Codice	 Descrizione	 Description	 Designation	 Benennung	 Descripción
52	08310700	COVER DESTRA SKYLINE	SKYLINE RIGHT COVER	COUVERTURE DROITE	RECHTE ABDECKUNG	COBERTURA
52	08310800	COVER SINISTRA SKYLINE	SKYLINE LEFT COVER	COUVERTURE GAUCHE	LINKE ABDECKUNG	COBERTURA IZQUIERDA
53	08132300	BACCHETTA IN FIBRA DI VETRO	GLASS FIBER WAND	BAGUETTE EN FIBRE DE VERRE	GLASFASERSTAB	VARILLA DE FIBRA DE VIDRIO
53	17796800	ASSIEME SENSORE E BARRA DI SUPPORTO PER SKYGUARD NON LAVORATO E NON VERNICIATO	SENSOR ASSEMBLY AND SUPPORT BAR FOR SKYGUARD NOT WORKED OUT AND NOT PAINTED	CAPTEURS	SENSOREN	SENSORES
53	18310600	MICRO	MICRO WITH WIRING	MICROINTERRPTEUR	MIKROSCHALTER	MICROINTERRUPTOR
53	27796800	SENSORE SKYGUARD	SENSOR SKYGUARD	CAPTEUR	SENSOR	SENSOR
54	07771500	MANIGLIA	HANDLE	POIGNÉE	GRIFF	MANIJA

-  SKY GUARD - SKY LINE
-  SKY GUARD - SKY LINE
-  SKY GUARD - SKY LINE



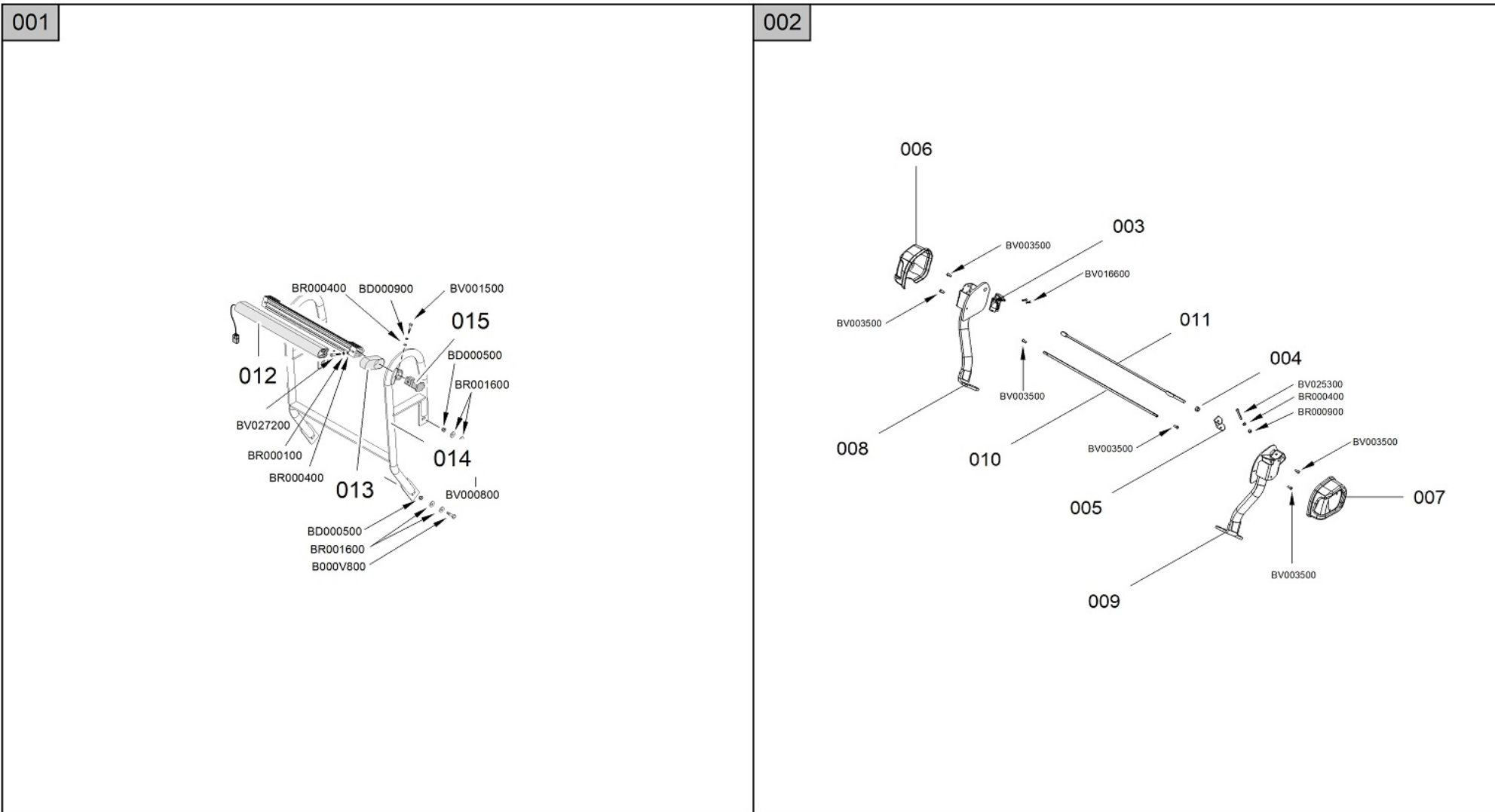

- SKY GUARD - SKY LINE 
- SKY GUARD - SKY LINE 







 SKY GUARD - SKY LINE

 SKY GUARD - SKY LINE



 SKY GUARD - SKY LINE
SKY GUARD - SKY LINE SKY GUARD - SKY LINE 

POS	Codice	 Descrizione	 Description	 Designation	 Benennung	 Descripción
2	18357200	KIT SKY LINE SU ATTACCO SKY GUARD MACCHINE JLG	CABLE ANTI- ENTRAPMENT SYSTEM	SYSTEME ANTI- ECRASEMENT AVEC CABLE	KABLE-ANTI- QUETSCH- VORRICHTUNG	SISTEMA ANTIAPLASTAMIENT O CON CABLE
2	18357300	KIT SKY LINE COMPLETO BIPOSTO HINOWA	SKYLINE COMPLETE KIT FOR 2 PERSON HINOWA	KIT SKY LINE	SKY LINE SATZ	KIT SKY LINE
3	38306500	SALDATO SUPPORTO SKYLINE DESTRO	WELDED SUPPORT ANTI-ENTRAPMENT SYSTEM (RIGHT)	SUPPORT SOUDE ANTI-ECRASEMENT SYSTEME (DROITE)	GESCHWEIßTE HALTERUNG ANTI- QUETSCH- VORRICHTUNG (RECHTS)	SOPORTE SALDATO SISTEMA ANTI- APLASTAMIENTO (DERECHA)
9	38306400	SALDATO SUPPORTO SKYLINE SINISTRO	WELDEL SUPPORT ANTI-ENTRAPMENT SYSTEM (LEFT)	SUPPORT SOUDE ANTI-ECRASEMENT SYSTEME (GAUCHE)	GESCHWEIßTE HALTERUNG ANTI- QUETSCH- VORRICHTUNG (LINKS)	SOPORTE SALDADO SISTEMA ANTI- APLASTAMIENTO (IZQUIERDA)

 ACCOPPIAMENTO MOTORE DIESEL- POMPA
 DIESEL ENGINE COUPLING - PUMP
 ACCOUPLEMENT MOTEUR DIESEL - POMPE

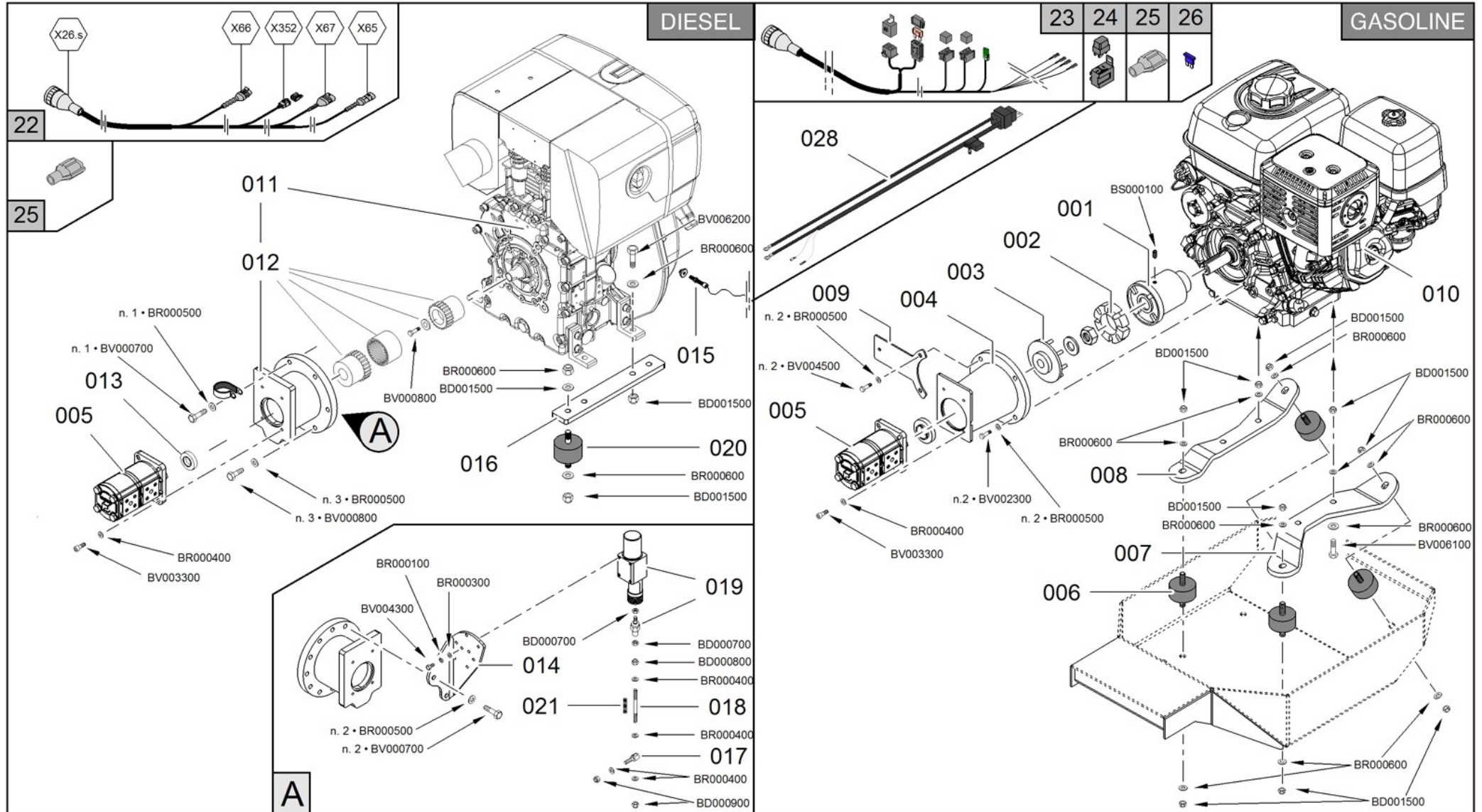
PUMPEN / DIESELMOTOR KUPPLUNG 
 ACOPLAMIENTO MOTOR DIESEL- BOMBA 



Main color codes:  J1 - JLG Cream,  J2 - JLG Orange,  C4 - Green





 ACCOPPIAMENTO MOTORE DIESEL- POMPA

 DIESEL ENGINE COUPLING - PUMP

 ACCOUPLEMENT MOTEUR DIESEL - POMPE

 PUMPEN / DIESELMOTOR KUPPLUNG

 ACOPLAMIENTO MOTOR DIESEL- BOMBA

POS	Codice	 Descrizione	 Description	 Designation	 Benennung	 Descripción
1	04310200	SEMIGIUNTO	HALF COUPLING	DEMI-JOINT	HALBVERBINDUNG	SEMI-ACOPLAMIENTO
2	04310100	INSERTO IN GOMMA	RUBBER INSERT	INSERT EN CAOUTCHOUC	GUMMIEINSATZ	INSERTO DE GOMA
3	04615300	GIUNTO	COUPLING	JOINT	VERBINDUNG	ACOPLAMIENTO
4	04310300	LANTERNA	LANTERN	LANTERNE	LANTERNE	LINTERNA
5	284674H3	POMPA IDRAULICA	HYDRAULIC PUMP	POMPE HYDRAULIQUE	HYDRAULIKPUMPE	BOMBA HYDRÁULICA
6	07804100	ANTIVIBRANTE VERSIONE BENZINA	ANTI-VIBRATING GASOLINE VERSION	ANTI - VIBRANT	VIBRATIONSDÄMPFER	ANTIVIBRANTE
7	077494Y1	PIATTO SINISTRO SUPPORTO MOTORE HONDA LL1570	LEFT PLATE SUPPORT HONDA MOTOR LL1570	PLAQUE GAUCHE SUPPORT MOTEUR	LINKE PLATTE MOTORHALTERUNG	PLACA IZQUIERDA SOPORTE MOTOR
8	077493Y1	PIATTO DESTRO SUPPORTO MOTORE HONDA LL1570	RIGHT PLATE SUPPORT HONDA MOTOR LL1570	PLAQUE DROITE SUPPORT MOTEUR	RECHTE PLATTE MOTORHALTERUNG	PLACA DERECHA SOPORTE MOTOR
9	061177H2	STAFFA	BRACKET	ÉTRIER	HALTEBÜGEL	ESTRIBO
10	27775900	MOTORE HONDA IGX390 MODIFICATO SENZA BLOCCHETTO CHIAVE DI ACCENSIONE MK2 (DA C170000893)	HONDA MOTOR IGX390 MODIFIED WITHOUT IGNITION SWITCH MK2 (FROM C170000893)	MOTEUR HONDA IGX390	HONDA MOTOR IGX390	MOTOR HONDA IGX390
11	27110400	MOTORE DIESEL HATZ 10HP VERSIONE CON PREDISPOSIZIONE REGOLAZIONI GIRI ELETTRONICA (NO CARB-EPA CERT)	HATZ DIESEL ENGINE 10HP VERSION WITH PREDISPOSITION TO ELECTRONIC SPEED REGULATION (NO CARB-EPA CERT)	MOTEUR DIESEL	DIESELMOTOR	MOTOR DIESEL





 ACCOPPIAMENTO MOTORE DIESEL- POMPA

 DIESEL ENGINE COUPLING - PUMP

 ACCOUPLEMENT MOTEUR DIESEL - POMPE

 PUMPEN / DIESELMOTOR KUPPLUNG



 ACOPLAMIENTO MOTOR DIESEL- BOMBA





POS	Codice	 Descrizione	 Description	 Designation	 Benennung	 Descripción
11	27676900	MOTORE DIESEL HATZ 1B40 RPM SENZA CHIAVE+ACCOPPIAM ENTO (TIER3 SOLO VERS. EU, NO CARB- EPA CERT) MK2 (DA C170000893)	DIESEL ENGINE HATZ 1B40 RPM WITHOUT KEY + COUPLING (TIER3 ONLY VERS. EU, NON-EPA CARB CERT) MK2 (FROM C170000893)	MOTEUR DIESEL HATZ	HATZ DIESEL MOTOR	MOTOR DIESEL HATZ
12	2558630001	ACCOPPIAMENTO MOTORE - POMPA	ENGINE COUPLING - PUMP	ACCOUPLEMENT MOTEUR - POMPE	PUMPEN-/MOTORKUP PLUNG	ACOPLAMIENTO MOTOR - BOMBA
13	055591Y2	DISTANZIALE	SPACER	ENTRETOISE	DISTANZSTÜCK	DISTANCIADOR
14	070989H2	STAFFA	BRACKET	ÉTRIER	HALTEBÜGEL	HALTEBÜGEL
15	26514900	SENSORE	SENSOR	CAPTEUR	SENSOR	SENSOR
16	057900Y1	PIATTO	PLATE	PLATEAU	PLATTE	PLACA
17	070986Y2	PERNO	PIN	GOUJON	ZAPFEN	PERNIO
18	07098700	TIRANTE	TIE ROD	TIRANT	TURMGESTÄNGE	TIRANTE
19	26551500	PISTONE	PISTON	PISTON	KOLBEN	PISTÓN
20	07804200	ANTIVIBRANTE VERSIONE BENZINA	ANTI-VIBRATING GASOLINE VERSION	ANTI - VIBRANT	VIBRATIONSDÄMPFE R	ANTIVIBRANTE
21	07098800	MOLLA	SPRING	RESSORT	FEDER	MUELLE
22	17729700	KIT ELE INTEGRAZIONE MOTORE DIESEL 10HP LL1570-X15JP-X430AJ	INTEGRATION KIT ELE DIESEL 10HP LL1570-X15JP-X430AJ	KIT ELECTRIQUE INTEGRATION	ELEKTRISCHE ERGÄNZUNGSATZ	KIT INTEGRACIÓN ELÉCTRICA
23	17729600	KIT ELE INTEGRAZIONE MOTORE BENZINA 13I LL1570	INTEGRATION KIT ELE MOTOR GASOLINE 13 THE LL1570	KIT ÉLECTRIQUE	ELEKTROSATZ	KIT ELÉCTRICO
24	1776330003	RELE' MINI TYCO 12V PER CONNETTORE A TENUTA (MK2 DA C170000893)	RELAY 'MINI 12V TYCO CONNECTOR SEAL (MK2 FROM C170000893)	RELAIS	RELAIS	RELÉ



 ACCOPPIAMENTO MOTORE DIESEL- POMPA



 DIESEL ENGINE COUPLING - PUMP

 ACCOUPLEMENT MOTEUR DIESEL - POMPE



 PUMPEN / DIESELMOTOR KUPPLUNG 
 ACOPLAMIENTO MOTOR DIESEL- BOMBA 



POS	Codice	 Descrizione	 Description	 Designation	 Benennung	 Descripción
24	1776330004	PORTA RELE' A TENUTA PER MINI TYCO 12V (MK2 DA C170000893)	HOLDER RELAY SEAL FOR MINI 12V TYCO (MK2 FROM C170000893)	PORTE RELAIS	RELAISHALTER	PORTARELÉ
24	1776330005	GOMMINO PER RELE' A TENUTA MINI TYCO 12V (MK2 DA C170000893)	RUBBER FOR RELAY SEAL MINI 12V TYCO (MK2 FROM C170000893)	JOINT RELÉ	GUMMIDICHTUNG	JUNTA DE GOMA
24	1776330007	PUNTALINI PER RELE' A TENUTA MINI TYCO 12V (MK2 DA C170000893)	FERRULE FOR RELAY SEAL MINI 12V TYCO (MK2 FROM C170000893)	BORNE	KLEMME	BORNE
25	1757250022	TAPPO CONNETTORE YAZAKI 2 VIE CON DIODO 1.5A	PLUG	BOUCHON	DECKEL	TAPA
26	1739150057	FUSIBILE A LAMA DA 30A	FUSE BLADE 30A	FUSIBLE À LAME 30A	30 A SICHERUNG	FUSIBILE A LAMA 30A
27	07819000	PARATIA PROTEZIONE CARBURATORE	PLATE PROTECTION CARB	PLAQUE PROTECTION	SCHUTZPLATTE	PLACE PROTECCIÓN
28	17965000	KIT RELE' AGGIUNTIVO SEGNALE MOTORE ACCESO HONDA IGX390	KIT RELAY 'ADDITIONAL SIGNAL ON HONDA MOTOR IGX390	KIT RELAIS	RELAIS KIT	KIT RELÉ

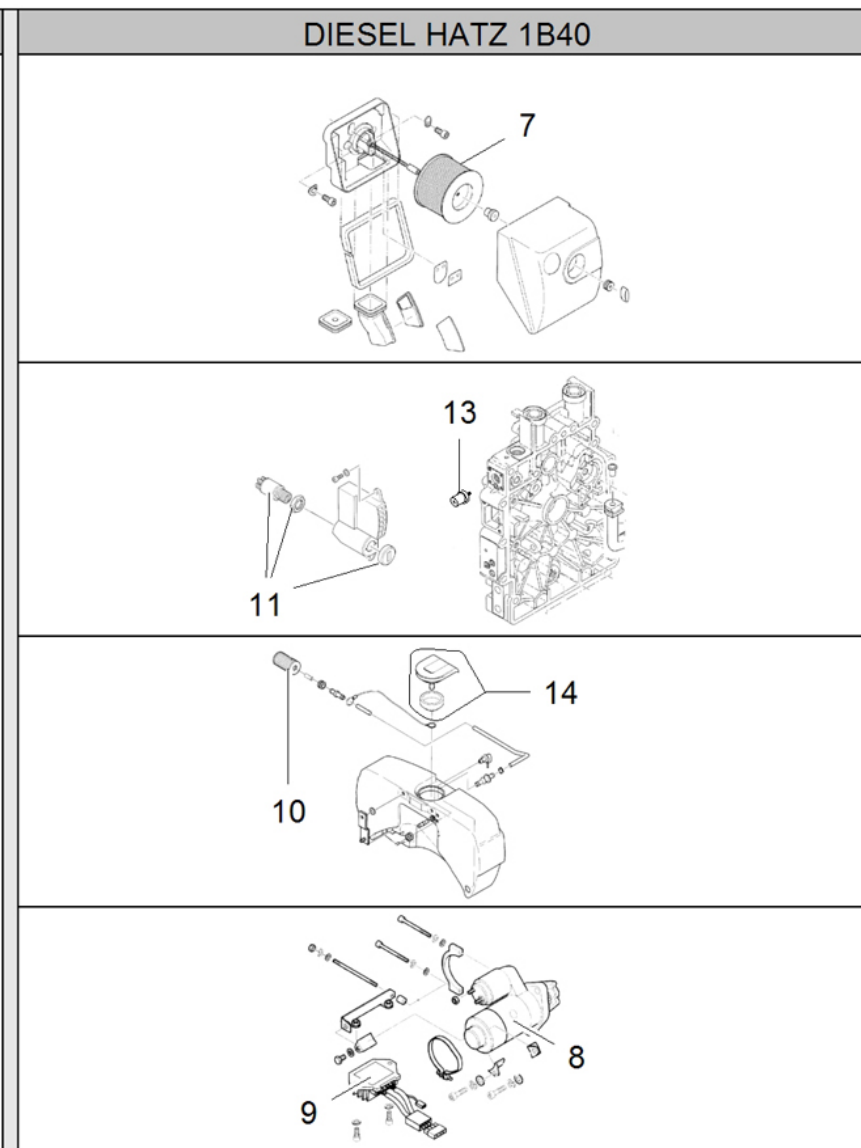
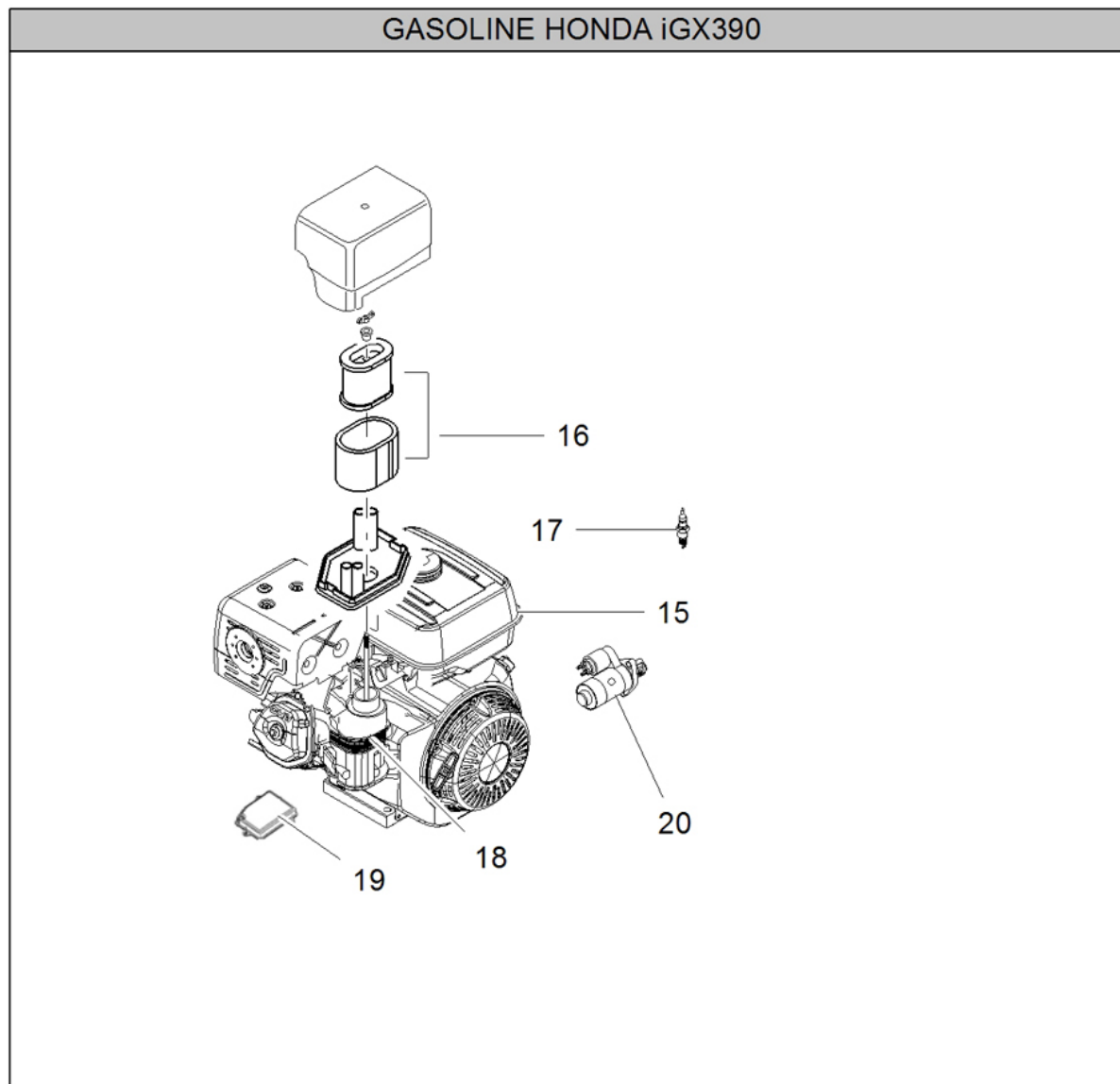



-  RICAMBI MOTORE
-  ENGINE SPARE PARTS
-  PIÈCES DÉTACHÉES DU MOTEUR



- MOTORERSATZTEILE 
- REPUESTOS MOTOR 







 RICAMBI MOTORE
 ENGINE SPARE PARTS
 PIÈCES DÉTACHÉES DU MOTEUR





MOTORERSATZTEILE 
 REPUESTOS MOTOR 



POS	Codice	 Descrizione	 Description	 Designation	 Benennung	 Descripción
7	2625560002	FILTRO ARIA	AIR FILTER	FILTER À AIR	LUFTFILTER	FILTRO AIRE
8	2631430005	MOTORINO D'AVVIAMENTO 1B40	STARTER MOTOR 1B40	MOTEUR DE DEMARREUR 1B40	STARTER MOTOR 1B40	MOTOR DE ARRANQUE 1B40
9	2558630005	REGOLATORE DI TENSIONE(5 WIRES VERSION)	VOLTAGE REGULATOR(5 WIRES VERSION)	RÉGULATEUR DE TENSION(5 WIRES VERSION)	SPANNUNGSREGLER(5 WIRES VERSION)	REGULADOR DE TENSIÓN(5 WIRES VERSION)
9	2558630005	REGOLATORE DI TENSIONE	VOLTAGE REGULATOR	RÉGULATEUR DE TENSION	SPANNUNGSREGLER	REGULADOR DE TENSIÓN
9	2558630009	REGOLATORE DI CORRENTE HATZ MODELLO DUCATI(6 WIRES VERSION)	CURRENT REGULATOR HATZ DUCATI MODEL(6 WIRES VERSION)	RÉGULATEUR DE TENSION MOTEUR HATZ(6 WIRES VERSION)	HYDRAULISCHER ANTRIEB(6 WIRES VERSION)	COMANDO HIDRÁULICO(6 WIRES VERSION)
9	2558630009	REGOLATORE DI CORRENTE HATZ MODELLO DUCATI	CURRENT REGULATOR HATZ DUCATI MODEL	RÉGULATEUR DE TENSION MOTEUR HATZ	HYDRAULISCHER ANTRIEB	COMANDO HIDRÁULICO
10	2558630003	FILTRO NAFTA MOTORE HATZ 1B30 E 1B40 (FINO AL SERIALE 1101917068544-1B40 E 1012917108022-1B30)	DIESEL FILTER FOR HATZ 1B30 AND 1B40 (UNTIL SERIAL 1101917068544-1B40 AND 1012917108022- 1B30)	FILTRE À GASOIL	KRAFTSTOFFFILTER	FILTRO GASÓLEO
11	2631430001	BLOCCHETTO CHIAVE	BLOCK	BLOC	BLOCK	BLOQUE
13	2558630008	SOLENOIDE	SOLENOID	SOLENOÏDE	SOLENOID	SOLENOIDE
14	2631430004	TAPPO SERBATOIO GASOLIO	FUEL TANK CAP	BOUCHON RÉSERVOIR GASOIL HATZ 1B30-1B40	TANKDECKEL	TAPA DEPÓSITO GASOIL
15	2775200002	SERBATOIO BENZINA COMPLETO HONDA IGX390	FUEL TANK COMPLETE HONDA IGX390	RÉSERVOIR ESSENCE	BENZINTANK	DEPÓSITO DE GASOLINA
16	2775200001	CARTUCCIA FILTRO ARIA COMPLETA HONDA IGX390	AIR FILTER CARTRIDGE COMPLETE HONDA IGX390	FILTRE À AIR	LUFTFILTER	FILTRO DE AIRE



Main color codes:  J1 - JLG Cream,  J2 - JLG Orange,  C4 - Green

 RICAMBI MOTORE
 ENGINE SPARE PARTS
 PIÈCES DÉTACHÉES DU MOTEUR



MOTORERSATZTEILE 
 REPUESTOS MOTOR 



POS	Codice	 Descrizione	 Description	 Designation	 Benennung	 Descripción
17	2558640003	CANDELA ACCENSIONE	SPARKING PLUG	BOUGIE ÉLECTRIQUE	ZÜNDKERZE	BUJÍA ENCENDIDO
18	2775200003	CARBURATORE COMPLETO HONDA IGX390 EURO 2(VALIDO FINO A SN MOTORE 3000001)	CARBURETOR COMPLETE HONDA IGX390 EURO 2 (VALID UNTIL ENGINE SN 3000001)	CARBURATEUR COMPLET HONDA IGX390 EURO 2 (VALABLE JUSQU'AU MOTEUR SN 3000001)	VERGASER KOMPLETT HONDA IGX390 EURO 2 (GÜLTIG BIS MOTOR SN 3000001)	CARBURADOR COMPLETO HONDA IGX390 EURO 2 (VÁLIDO HASTA MOTOR SN 3000001)
18	2775200006	CARBURATORE COMPLETO HONDA IGX390 STAGE V (VALIDO DA SN MOTORE 3000001)	CARBURETOR COMPLETE HONDA IGX390 STAGE V (VALID FROM ENGINE SN 3000001)	CARBURATEUR COMPLET HONDA IGX390 STAGE V (VALABLE A PARTIR DU NUMERO DE SERIE 3000001)	VERGASER KMPL. HONDA IGX390 STAGEV (GÜLTIG AB SERIENNR. 3000001)	CARBURADOR COMPLETO HONDA IGX390 STAGE V (VÁLIDO A PARTIR DEL NÚMERO DE SERIE 3000001)
19	2775200004	CENTRALINA ELETTRONICA HONDA IGX390	ELECTRONIC CONTROL UNIT HONDA IGX390	UNITÉ ÉLECTRONIQUE	ELEKTRONISCHE EINHEIT	UNIDAD ELECTRÓNICA
20	2775200005	MOTORINO DI AVVIAMENTO COMPLETO HONDA IGX390	ELECTRIC STARTER COMPLETE HONDA IGX390	MOTEUR DE DÉMARRAGE	MOTORSTART	MOTOR DE ARRANQUE

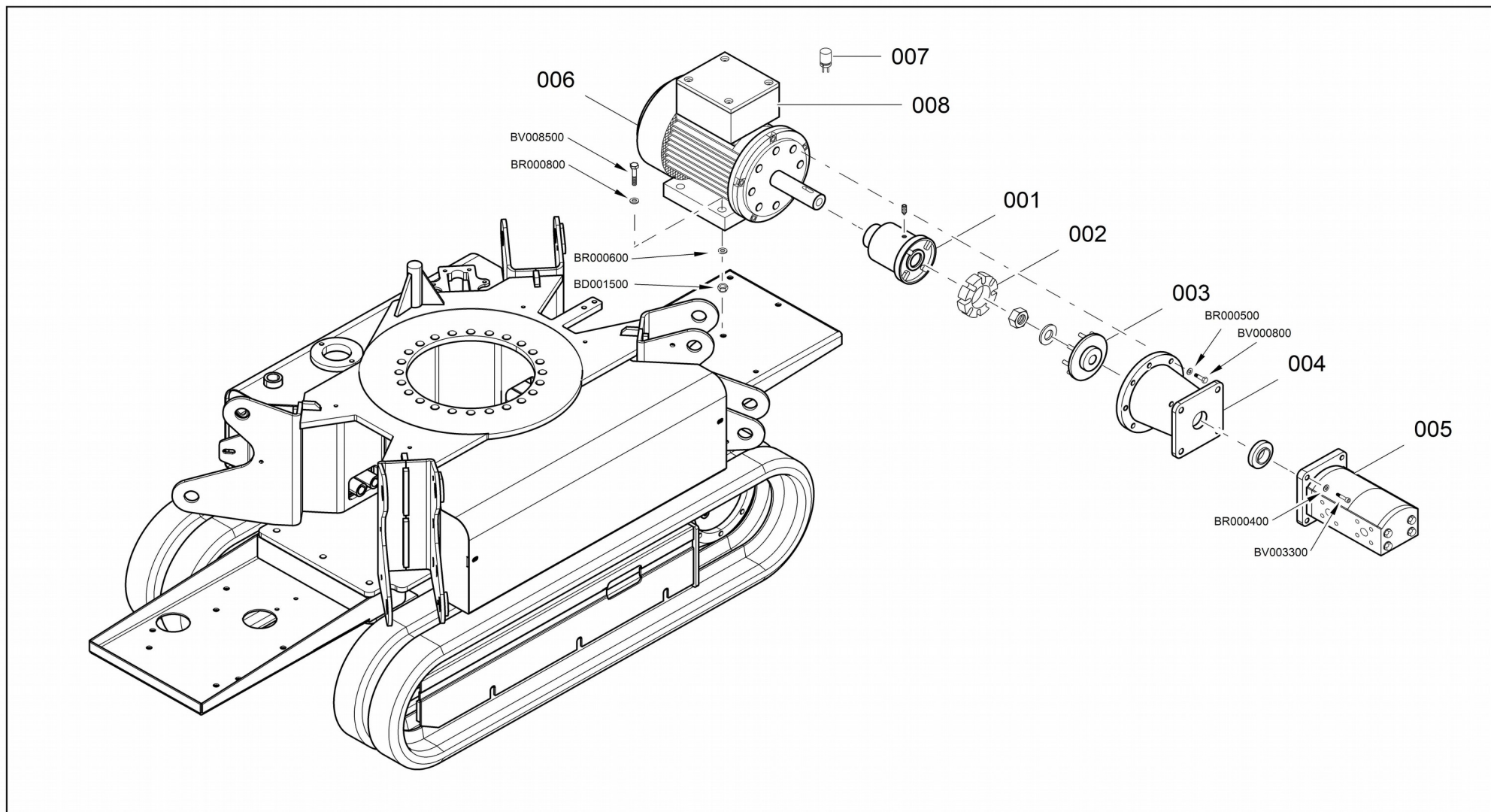

 MOTORE ELETTRICO
 ELECTRIC MOTOR
 MOTEUR ÉLECTRIQUE





E-MOTOR 
MOTOR ELÉCTRICO 







Main color codes:  J1 - JLG Cream,  J2 - JLG Orange,  C4 - Green





 MOTORE ELETTRICO
 ELECTRIC MOTOR
 MOTEUR ÉLECTRIQUE

E-MOTOR 
MOTOR ELÉCTRICO 

POS	Codice	 Descrizione	 Description	 Designation	 Benennung	 Descripción
1	05563400	SEMIGIUNTO VERSIONE MOTORE ELETTRICO STANDARD	HALF COUPLING ELECTRIC MOTOR STANDARD VERSION	DEMI-JOINT	HALBKUPPLUNG	SEMI-ACOPLAMIENTO
1	06997800	SEMIGIUNTO VERSIONE LITIO	HALF COUPLING LITHIUM VERSION	DEMI-JOINT	HALBKUPPLUNG	SEMI-ACOPLAMIENTO
2	04310100	INSERTO IN GOMMA	RUBBER INSERT	INSERT EN CAOUTCHOUC	GUMMIEINSATZ	INSERTO DE GOMA
3	04615300	GIUNTO	COUPLING	JOINT	VERBINDUNG	ACOPLAMIENTO
4	05510200	LANTERNA	LANTERN	LANTERNE	LATERNE	LINTERNA
5	263281H3	POMPA IDRAULICA	HYDRAULIC PUMP	POMPE HYDRAULIQUE	HYDRAULIKPUMPE	BOMBA HYDRÁULICA
6	25576400	MOTORE ELETTRICO 110V	ELECTRIC MOTOR 110V	MOTEUR ÉLECTRIQUE 110V	E-MOTOR 110V	MOTOR ELÉCTRICO 110V
6	26219000	MOTORE ELETTRICO 230V 60HZ	ELECTRIC MOTOR 230V 60HZ	MOTEUR ÉLECTRIQUE 230V 60HZ	E-MOTOR 230V 60HZ	MOTOR ELÉCTRICO 230V 60HZ
6	26328300	MOTORE ELETTRICO 120V 60HZ 1.2KW 16A	ELECTRIC MOTOR 120V 60HZ 1.2KW 16A	MOTEUR ÉLECTRIQUE	E-MOTOR	MOTOR ELÉCTRICO
6	26774500	MOTORE ELETTRICO LITHIUM 2KW	ELECTRIC MOTOR LITHIUM 2KW	MOTEUR ÉLECTRIQUE	E-MOTOR	MOTOR ELÉCTRICO
6	27691100	MOTORE ELETTRICO 230V 50HZ MK2 (DA C170000893)	ELECTRIC MOTOR 230V 50HZ MK2 (FROM C170000893)	MOTEUR ÉLECTRIQUE 230V 50HZ MK2 (FROM C170000893)	E-MOTOR 230V 50HZ MK2 (FROM C170000893)	MOTOR ELÉCTRICO 230V 50HZ MK2 (FROM C170000893)
7	2557640001	CONDENSATORE 110V MF200 D=65	CAPACITOR 110V MF200 D=65	CONDENSATEUR	CAPACITOR	CAPACITOR
7	2557640002	CONDENSATORE 110V MF500	CAPACITOR 110V MF500	CONDENSATEUR	CAPACITOR	CAPACITOR
7	2632830001	CONDENSATORE PER MOTORE 120V MF120 D=55	CAPACITOR MOTOR 120V MF120 D = 55	CONDENSATEUR	KONDENSATOR	CONDENSADOR

Main color codes:  J1 - JLG Cream,  J2 - JLG Orange,  C4 - Green



 MOTORE ELETTRICO ELECTRIC MOTOR MOTEUR ÉLECTRIQUEE-MOTOR MOTOR ELÉCTRICO 

POS	Codice	 Descrizione	 Description	 Designation	 Benennung	 Descripción
7	2632830002	CONDENSATORE PER MOTORE 120V MF160 D=60	CAPACITOR MOTOR 120V MF160 D = 60	CONDENSATEUR	KONDENSATOR	CONDENSADOR
7	2769110001	CONDENSATORE 230V MF80 D=60 CL.B	CAPACITOR 230V MF80 D=60 CL.B	CONDENSATEUR D=60 CL.B	KONDENSATOR D=60 CL.B	CONDENSADOR D=60 CL.B
8	2769110002	SCATOLA CONDENSATORE CON GUARNIZIONE	CONDENSER BOX WITH GASKET	BOÎTE DE CONDENSEUR	KONDENSATORKAST EN	CAJA CONDENSADOR



 IMPIANTO IDRAULICO MANDATE E SCARICO

 SUPPLY AND DISCHARGE HYDRAULIC SYSTEM

 SYSTÈME HYDRAULIQUE REFOULEMENT ET DÉCHARGEME

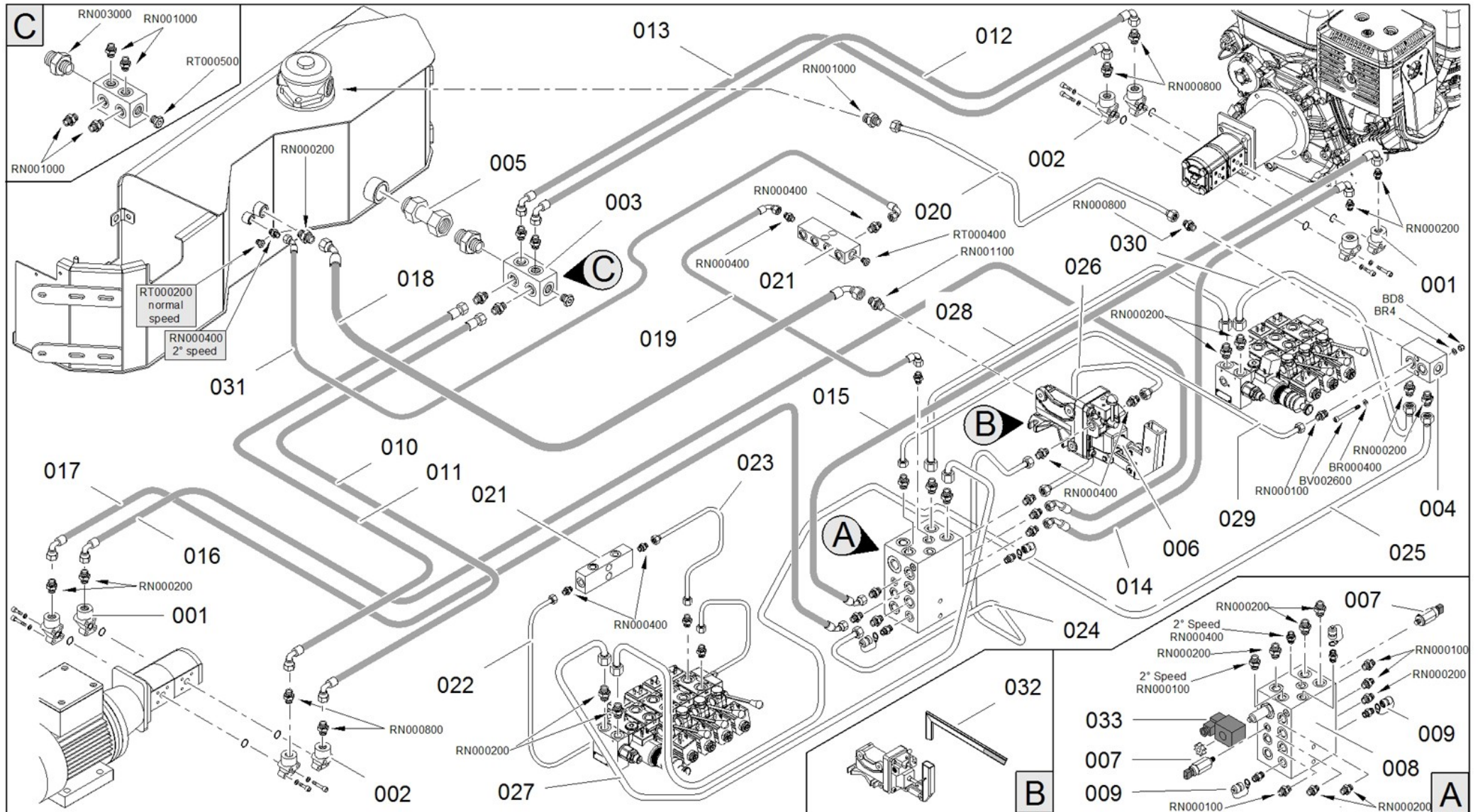
HYDRAULIKANLAGE VORLÄUFE UND RÜCKLAUF 
 INSTALACIÓN HIDRÁULICA IMPULSIONES Y DESCARGA 









Main color codes:  J1 - JLG Cream,  J2 - JLG Orange,  C4 - Green



 IMPIANTO IDRAULICO MANDATE E SCARICO

 SUPPLY AND DISCHARGE HYDRAULIC SYSTEM

 SYSTÈME HYDRAULIQUE REFOULEMENT ET DÉCHARGEME

 HYDRAULIKANLAGE VORLÄUFE UND RÜCKLAUF 
 INSTALACIÓN HIDRÁULICA IMPULSIONES Y DESCARGA 



POS	Codice	 Descrizione	 Description	 Designation	 Benennung	 Descripción
1	04048100	FLANGIA 3/8" G	FLANGE 3/8" G	BRIDE 3/8" G	FLANSCH 3/8" G	BRIDA 3/8" G
2	04845400	FLANGIA 1/2"G	FLANGE 1/2"G	BRIDE 1/2"G	FLANSCH 1/2"G	BRIDA 1/2"G
3	07764900	COLLETTORE ASPIRAZIONI POMPE LL1570	INTAKE MANIFOLD PUMPS LL1570	COLLECTEUR	KOLLEKTOR	COLECTOR
4	05497500	BLOCCHETTO TUBI	HOSES BLOCK	BLOC TUYAUX	ROHRBLOCK	BLOQUE TUBOS
5	07770500	RACCORDO PROLUNGA M-F ¼ H=20	FITTING	RACCORD	ANSCHLUSS	CONEXIÓN
6	26459400	POMPA A MANO	HAND PUMP	POMPE MANUELLE	HANDPUMPE	BOMBA DE MANO
7	26964400	PRESSOSTATO	PRESSURE SWITCH	PRESSOSTAT	DRUCKSCHALTER	PRESÓSTATO
8	17772200	VALVOLA IDRAULICA	HYDRAULIC VALVE	VALVE HYDRAULIQUE	HYDRAULIKVENTIL	VÁLVULA HIDRÁULICA
8	17805400	VALVOLA IDRAULICA	HYDRAULIC VALVE	VALVE HYDRAULIQUE	HYDRAULIKVENTIL	VÁLVULA HIDRÁULICA
9	03014400	PROVA PRESSIONE 1/4" G	PRESSURE TEST 1/4" G	PREUVE PRESSION 1/4" G	DRUCKKONTROLLE 1/4" G	PRUEBA PRESIÓN 1/4" G
10	07781100	TUBO FLESSIBILE	FLEXIBLE PIPE	TUYAU FLEXIBLE	SCHLAUCH	TUBO FLEXIBLE
11	07781200	TUBO FLESSIBILE	FLEXIBLE PIPE	TUYAU FLEXIBLE	SCHLAUCH	TUBO FLEXIBLE
12	07780900	TUBO FLESSIBILE	FLEXIBLE PIPE	TUYAU FLEXIBLE	SCHLAUCH	TUBO FLEXIBLE
13	07781000	TUBO FLESSIBILE	FLEXIBLE PIPE	TUYAU FLEXIBLE	SCHLAUCH	TUBO FLEXIBLE
14	07813300	TUBO FLESSIBILE	FLEXIBLE PIPE	TUYAU FLEXIBLE	SCHLAUCH	TUBO FLEXIBLE
15	07813600	TUBO FLESSIBILE	FLEXIBLE PIPE	TUYAU FLEXIBLE	SCHLAUCH	TUBO FLEXIBLE
16	07813400	TUBO FLESSIBILE	FLEXIBLE PIPE	TUYAU FLEXIBLE	SCHLAUCH	TUBO FLEXIBLE
17	07813500	TUBO FLESSIBILE	FLEXIBLE PIPE	TUYAU FLEXIBLE	SCHLAUCH	TUBO FLEXIBLE
18	07784000	TUBO FLESSIBILE	FLEXIBLE PIPE	TUYAU FLEXIBLE	SCHLAUCH	TUBO FLEXIBLE
19	07813700	TUBO FLESSIBILE	FLEXIBLE PIPE	TUYAU FLEXIBLE	SCHLAUCH	TUBO FLEXIBLE
20	07773000	TUBO RIGIDO	RIGID PIPE	TUYAU	SCHLAUCH	TUBO
21	04707700	COLLETTORE	MANIFOLD	COLLECTEUR	KOLLEKTOR	COLECTOR
22	07747400	TUBO RIGIDO	RIGID PIPE	TUYAU	ROHR	TUBO
23	07747300	TUBO RIGIDO	RIGID PIPE	TUYAU	ROHR	TUBO
24	07772700	TUBO RIGIDO	RIGID PIPE	TUYAU	SCHLAUCH	TUBO
25	07772300	TUBO RIGIDO	RIGID PIPE	TUYAU	SCHLAUCH	TUBO





 Main color codes:  J1 - JLG Cream,  J2 - JLG Orange,  C4 - Green

 IMPIANTO IDRAULICO MANDATE E SCARICO

 SUPPLY AND DISCHARGE HYDRAULIC SYSTEM

 SYSTÈME HYDRAULIQUE REFOULEMENT ET DÉCHARGEME



 HYDRAULIKANLAGE VORLÄUFE UND RÜCKLAUF 
 INSTALACIÓN HIDRÁULICA IMPULSIONES Y DESCARGA 

POS	Codice	 Descrizione	 Description	 Designation	 Benennung	 Descripción
26	07772800	TUBO RIGIDO	RIGID PIPE	TUYAU	SCHLAUCH	TUBO
27	07772500	TUBO RIGIDO	RIGID PIPE	TUYAU	SCHLAUCH	TUBO
28	07772600	TUBO RIGIDO	RIGID PIPE	TUYAU	SCHLAUCH	TUBO
29	07772900	TUBO RIGIDO	RIGID PIPE	TUYAU	SCHLAUCH	TUBO
30	07772400	TUBO RIGIDO	RIGID PIPE	TUYAU	SCHLAUCH	TUBO
31	07783000	TUBO FLESSIBILE	FLEXIBLE PIPE	TUYAU FLEXIBLE	SCHLAUCH	TUBO FLEXIBLE
32	16517700	LEVA	LEVER	LEVIER	HEBEL	PALANCA
33	07845200	BOBINA PER DISTRIBUTORE IDRAULICO SENZA DIODO CONNETTORE DEUTSCH	COIL FOR HYDRAULIC DISTRIBUTOR WITHOUT DIODE, CONNECTOR DEUTSCH	BOBINE	SPULE	BOBINA
33	1777220002	VALVOLA IDRAULICA	HYDRAULIC VALVE	VALVE HYDRAULIQUE	HYDRAULIKVENTIL	VÁLVULA HIDRÁULICA
33	1777220003	VALVOLA IDRAULICA	HYDRAULIC VALVE	VALVE HYDRAULIQUE	HYDRAULIKVENTIL	VÁLVULA HIDRÁULICA



 IMPIANTO IDRAULICO MANDATE E SCARICO

 SUPPLY AND DISCHARGE HYDRAULIC SYSTEM

 SYSTÈME HYDRAULIQUE REFOULEMENT ET DÉCHARGEMENT

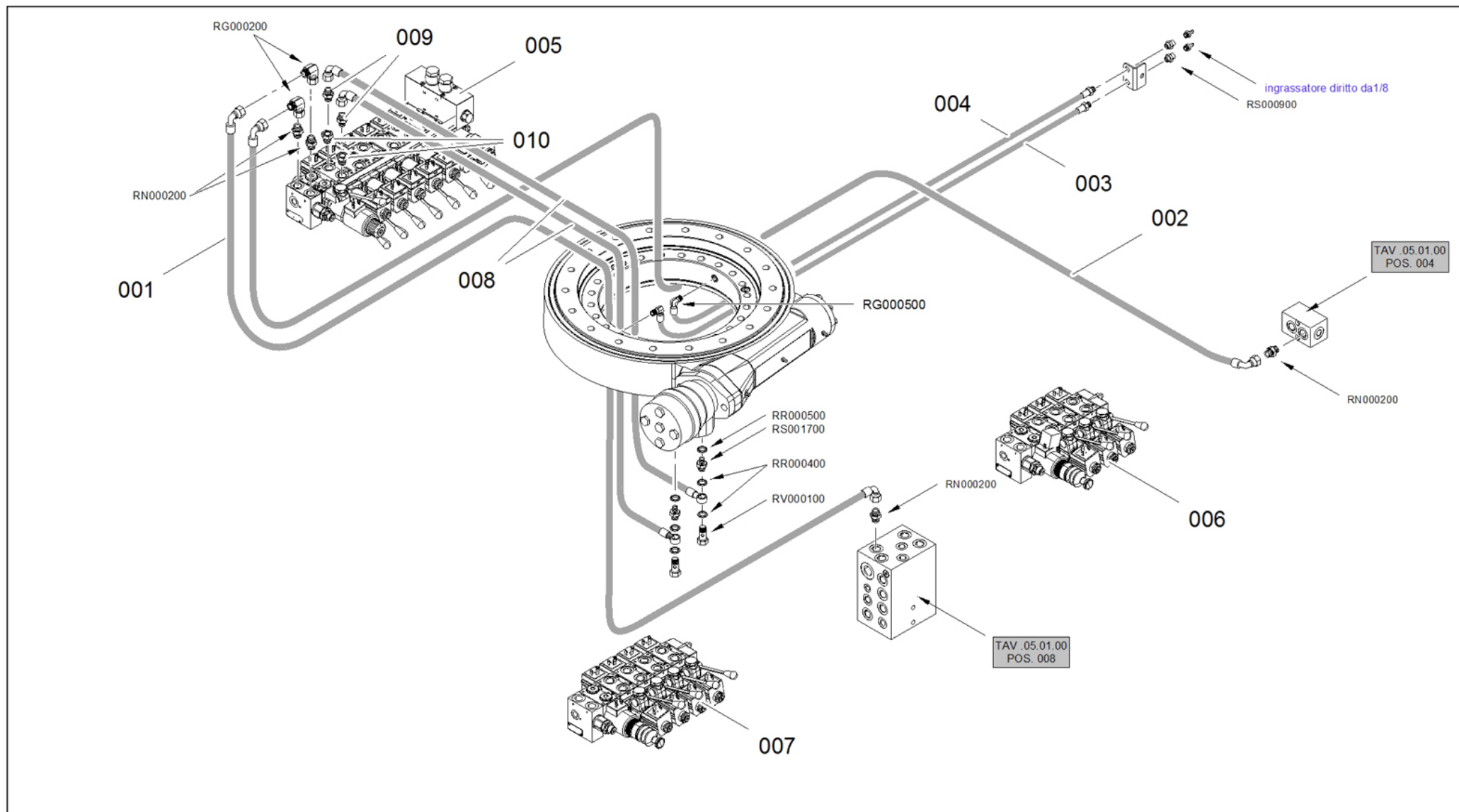
HYDRAULIKANLAGE VORLÄUFE UND RÜCKLAUF 
 INSTALACIÓN HIDRÁULICA IMPULSIONES Y DESCARGA 









Main color codes:  J1 - JLG Cream,  J2 - JLG Orange,  C4 - Green



 IMPIANTO IDRAULICO MANDATE E SCARICO



 SUPPLY AND DISCHARGE HYDRAULIC SYSTEM

 SYSTÈME HYDRAULIQUE REFOULEMENT ET DÉCHARGEMENT



 HYDRAULIKANLAGE VORLÄUFE UND RÜCKLAUF 
 INSTALACIÓN HIDRÁULICA IMPULSIONES Y DESCARGA 



POS	Codice	 Descrizione	 Description	 Designation	 Benennung	 Descripción
1	07813900	TUBO FLESSIBILE	FLEXIBLE PIPE	TUYAU FLEXIBLE	SCHLAUCH	TUBO FLEXIBLE
2	07813800	TUBO FLESSIBILE	FLEXIBLE PIPE	TUYAU FLEXIBLE	SCHLAUCH	TUBO FLEXIBLE
3	07784100	TUBO FLESSIBILE	FLEXIBLE PIPE	TUYAU FLEXIBLE	SCHLAUCH	TUBO FLEXIBLE
4	07784200	TUBO FLESSIBILE	FLEXIBLE PIPE	TUYAU FLEXIBLE	SCHLAUCH	TUBO FLEXIBLE
5	27533400	DISTRIBUTORE IDRAULICO 7 ELEMENTI PARTE AEREA CON PULSANTE (FOR LL1775-X17JP-X500AJ-LL2010-X20JP-X600AJ MK2 FROM C170000893)	HYDRAULIC DISTRIBUTOR 7 ELEMENTS AERIAL PART WITH BUTTON (FOR LL1775-X17JP-X500AJ-LL2010-X20JP-X600AJ MK2 FROM C170000893)	DISTRIBUTEUR HYDRAULIQUE (FOR LL1775-X17JP-X500AJ-LL2010-X20JP-X600AJ MK2 FROM C170000893)	HYDRAULISCHER VERTEILER (FOR LL1775-X17JP-X500AJ-LL2010-X20JP-X600AJ MK2 FROM C170000893)	DISTRIBUIDOR HIDRÁULICO (FOR LL1775-X17JP-X500AJ-LL2010-X20JP-X600AJ MK2 FROM C170000893)
6	27299000	DISTRIBUTORE LC STABILIZZATORI-TRAINO 3 ELEMENTI CON LEVE EMERGENZA A PULSANTE	HYDRAULIC DISTRIBUTOR STABILIZERS-TRACKS 3 PARTS WITH LEVERS EMERGENCY BUTTON	DISTRIBUTEUR HYDRAULIQUE	HYDR. REGELSTEUERGERÄT	DISTRIBUIDOR HIDRÁULICO
7	27299100	DISTRIBUTORE LC STABILIZZATORI-TRAINO 4 ELEMENTI CON LEVE EMERGENZA A PULSANTE	HYDRAULIC DISTRIBUTOR STABILIZERS-TRACKS 4 PARTS WITH LEVERS EMERGENCY BUTTON	DISTRIBUTEUR HYDRAULIQUE	HYDRAULIKVENTILB LOCK	DISTRIBUIDOR HIDRÁULICO
8	07784500	TUBO FLESSIBILE	FLEXIBLE PIPE	TUYAU FLEXIBLE	SCHLAUCH	TUBO FLEXIBLE
9	06786700	RACCORDO	FITTING	RACCORD	ANSCHLUSS	CONEXIÓN
10	RS000700	RIDUZIONE M-F GAS 1" * 1/2"	REDUCING GAS M-F 1" * 1/2"	RÉDUCTION M-F GAS 1" * 1/2"	REDUZIERUNG GAS M-F 1" * 1/2"	REDUCCIÓN M-F GAS 1" * 1/2"

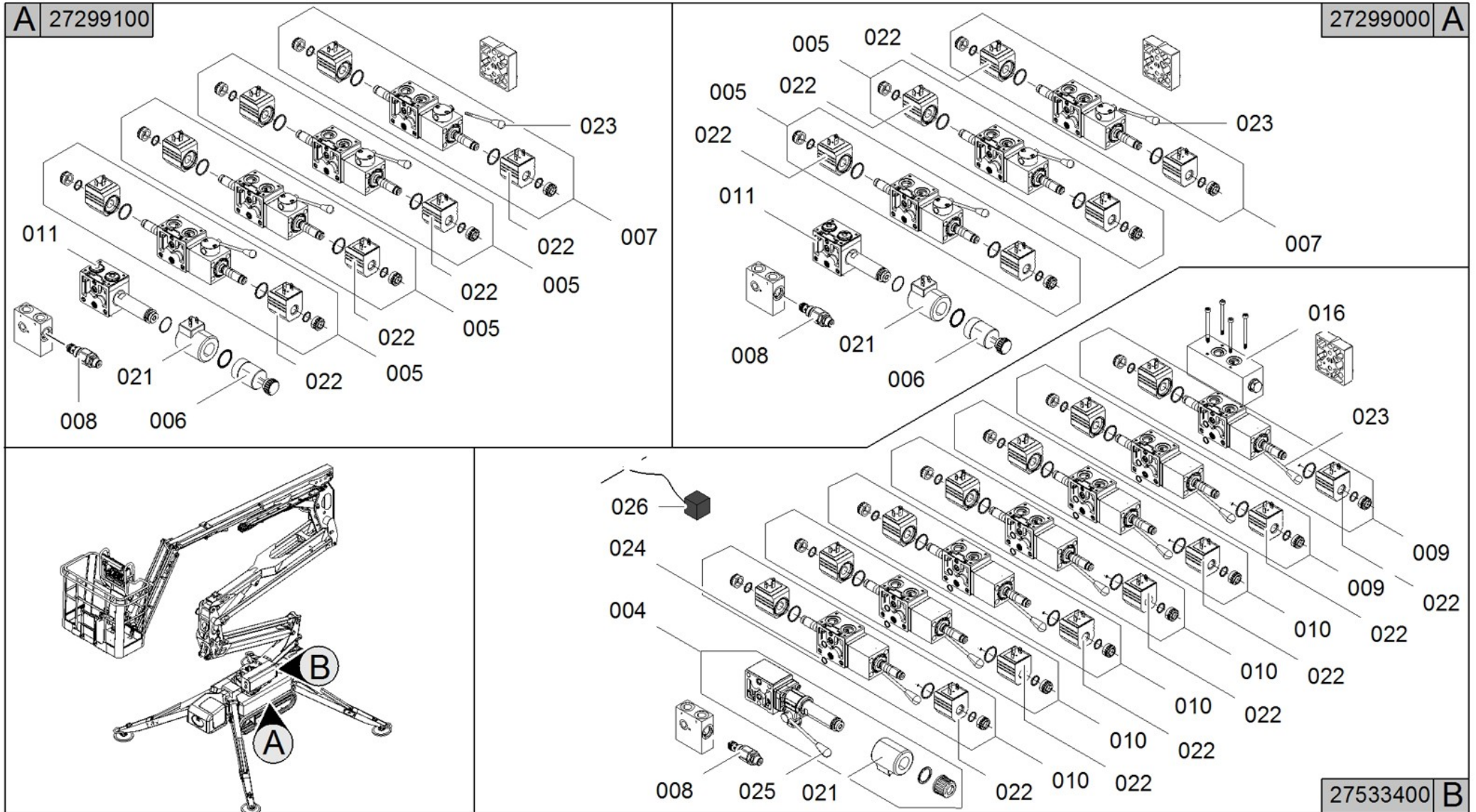

 DISTRIBUTORI IDRAULICI
 HYDRAULIC DISTRIBUTORS
 DISTRIBUTEURS HYDRAULIQUES





HYDRAULISCHE REGELSTEUERGERÄTE 
 DISTRIBUIDORES HIDRÁULICOS 









Main color codes:  J1 - JLG Cream,  J2 - JLG Orange,  C4 - Green



 DISTRIBUTORI IDRAULICI
 HYDRAULIC DISTRIBUTORS
 DISTRIBUTEURS HYDRAULIQUES





HYDRAULISCHE REGELSTEUERGERÄTE 
DISTRIBUIDORES HIDRÁULICOS 

POS	Codice	 Descrizione	 Description	 Designation	 Benennung	 Descripción
4	2753340004	ELEMENTO DISTRIBUTORE COMPLETO DI PROPORZIONALE PARTE AEREA CON LEVA ROSSA (LATO 1)	VALVE BLOCK ELEMENT	ELEMENT DISTRIBUTEUR	VENTILBLOCKSATZ	ELEMENTO DISTRIBUIDOR
5	2645900005	SEZIONE DISTRIBUTORE AB CHIUSO CON LEVA (LATO A) E BOBINA	VALVE BLOCK SECTION AB CLOSED WITH LEVER (SIDE A) AND COIL	SECTION DISTRIBUTEUR	VENTILBLOCKSEKTIO N	SECCIÓN DISTRIBUIDOR
6	07324900	COMANDO MANUALE EMERGENZA CON RITORNO A MOLLA	EMERGENCY MAUAL CONTROL WITH SPRING RETURN	COMMANDE MANUEL D'URGENCE	MANUELLES ANTRIEB FÜR NOTSTAND	MANDO MANUAL DE EMERGENCIA
7	2645900006	SEZIONE DISTRIBUTORE ABT CON LEVA (LATO A) E BOBINA	VALVE BLOCK SECTION ABT WITH LEVER (SIDE A) AND COIL	SECTION DISTRIBUTEUR	VENTILBLOCKSEKTIO N	SECCIÓN DISTRIBUIDOR
8	2645900002	CARTUCCIA VALVOLA DI MASSIMA PRESSIONE	CARTRIDGE PRESSURE RELIEF VALVE	CARTOUCHE SOUPAPE DE SÉCURITÉ	PARTONE ÜBERDRUCKVENTIL	CATUCHO VÁLVULA LIMITADORA DE PRESIÓN
9	2753340002	SEZIONE DISTRIBUTORE ABT CON LEVA (LATO 1) E BOBINA	SECTION DISTRIBUTOR ABT WITH LEVER (SIDE 1) AND COIL	SECTION DISTRIBUTEUR	VENTILBLOCKSEKTIO N	SECCIÓN DISTRIBUIDOR
10	2753340001	SEZIONE DISTRIBUTORE AB CHIUSO CON LEVA (LATO 1) E BOBINA	SECTION DISTRIBUTOR AB CLOSED WITH LEVER (SIDE 1) AND COIL	SECTION DISTRIBUTEUR	VENTILBLOCKSEKTIO N	SECCIÓN DISTRIBUIDOR
11	2729900001	VALVOLA PROPORZIONALE TRAINI CON BOBINA E SENZA COMANDO MANUALE A MOLLA	PROPORTIONAL VALVE FOR TRACK WITH COIL AND WITHOUT MANUAL SPRING	SOUPAPE PROPORTIONELLE	PROPORTIONALVENT IL	VÁLVULA PROPORCIONAL

Main color codes:  J1 - JLG Cream,  J2 - JLG Orange,  C4 - Green

 DISTRIBUTORI IDRAULICI
 HYDRAULIC DISTRIBUTORS
 DISTRIBUTEURS HYDRAULIQUES



HYDRAULISCHE REGELSTEUERGERÄTE 
 DISTRIBUIDORES HIDRÁULICOS 





POS	Codice	 Descrizione	 Description	 Designation	 Benennung	 Descripción
16	2585560004	BLOCCO VALVOLA BILANCIAMENTO BRACCI SU DISTRIBUTORI PARTE AEREA	BALANCING VALVE BLOCK BOOMS OF DISTRIBUTORS AERIAL PART	BLOC SOUPAPE	VENTILSPERRE	BLOQUE VÁLVULA
21	06037100	BOBINA PER VALVOLA PROPORZIONALE PARTE CARRO	COIL PROPORTIONAL VALVE FOR UNDERCARRIAGE	BOBINE	SPULE	BOBINA
22	05913800	BOBINA PER ON-OFF	COIL FOR ON-OFF	BOBINE	SPULE	BOBINA
23	07300200	LEVA DISTRIBUTORE	LEVER HYDRAULIC DISTRIBUTOR	LEVIER	HEBEL	PALANCA
24	2585560005	O-RING	O-RING	O-RING	O-RING	O-RING
25	2753340003	LEVA ROSSA DISTRIBUTORE	RED LEVER HYDRAULIC DISTRIBUTOR	LEVIER	HEBEL	PALANCA
26	1730720001	ELETTROVALVOLA ON-OFF CON LED	SOLENOID ON-OFF WITH LED	ELECTROVANNE ON- OFF AVEC LED	SOLENOID ON-OFF WITH LED	SOLENOIDE ON-OFF CON LED



 IMPIANTO IDRAULICO TRAZIONE

 HYDRAULIC SYSTEM FOR TRACTION



 SYSTÈME HYDRAULIQUE DE TRACTION



 HYDRAULIKANLAGE ANTRIEB 
 INSTALACIÓN HIDRÁULICA TRACCIÓN 

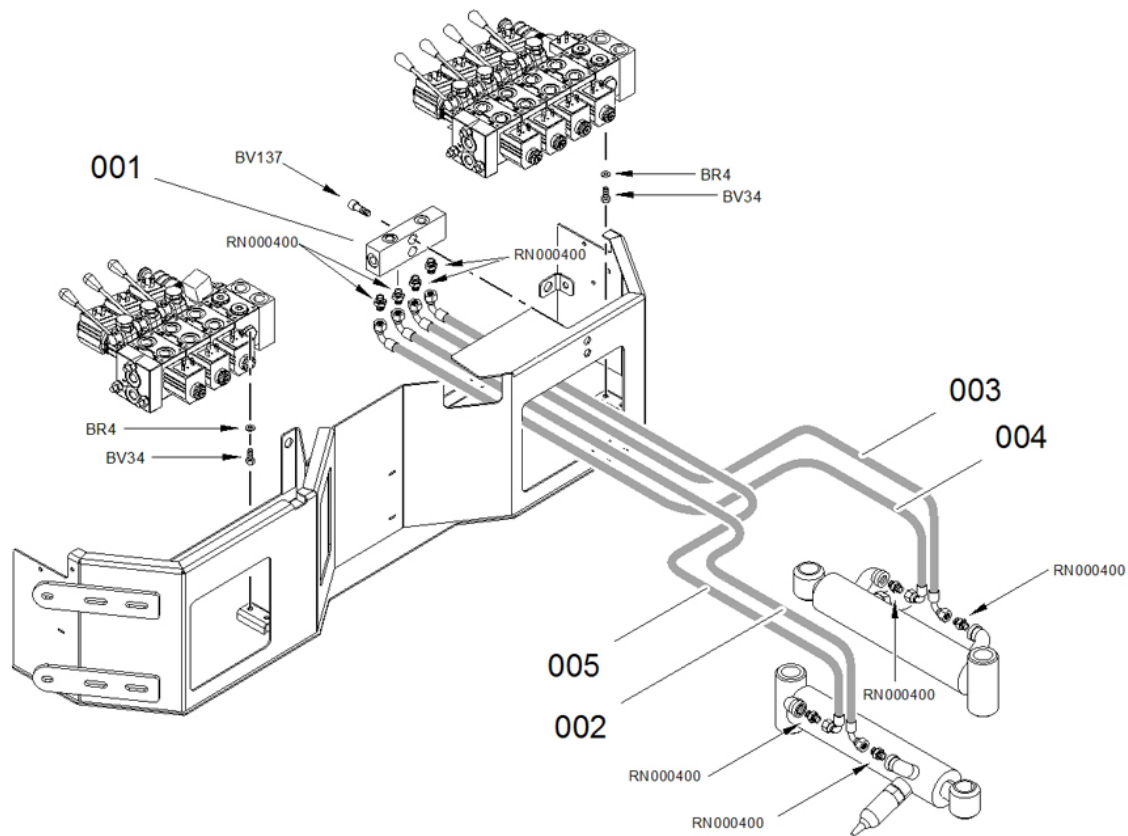



POS	Codice	 Descrizione	 Description	 Designation	 Benennung	 Descripción
1	07782600	TUBO FLESSIBILE	FLEXIBLE PIPE	TUYAU FLEXIBLE	SCHLAUCH	TUBO FLEXIBLE
2	07782500	TUBO FLESSIBILE	FLEXIBLE PIPE	TUYAU FLEXIBLE	SCHLAUCH	TUBO FLEXIBLE
3	05093900	RACCORDO 12L-3/8 JIS ESAGONO 22 H40	12L-FITTING 3/8 JIS HEX22 H40	RACCORD	ANSCHLUSS	CONEXIÓN
4	07783700	TUBO FLESSIBILE	FLEXIBLE PIPE	TUYAU FLEXIBLE	SCHLAUCH	TUBO FLEXIBLE
5	07783800	TUBO FLESSIBILE	FLEXIBLE PIPE	TUYAU FLEXIBLE	SCHLAUCH	TUBO FLEXIBLE
6	07783900	TUBO FLESSIBILE	FLEXIBLE PIPE	TUYAU FLEXIBLE	SCHLAUCH	TUBO FLEXIBLE
7	07782800	TUBO FLESSIBILE	FLEXIBLE PIPE	TUYAU FLEXIBLE	SCHLAUCH	TUBO FLEXIBLE
8	07782700	TUBO FLESSIBILE	FLEXIBLE PIPE	TUYAU FLEXIBLE	SCHLAUCH	TUBO FLEXIBLE
9	05582000	RACCORDO	FITTING	RACCORD	ANSCHLUSS	CONEXIÓN



 Main color codes:  J1 - JLG Cream,  J2 - JLG Orange,  C4 - Green





 IMPIANTO IDRAULICO ALLARGAMENTO CARRO
 HYDRAULIC SYSTEM UNDERCARRIAGE EXPANSION
 SYSTÈME HYDRAULIQUE EXTENSION DU CHARIOT



HYDRAULIKANLAGE VERBREITERUNG WAGEN 
 INSTALACIÓN HIDRAULICA ENSANCHAMIENTO CARRO 

POS	Codice	 Descrizione	 Description	 Designation	 Benennung	 Descripción
1	04707700	COLLETTORE	MANIFOLD	COLLECTEUR	KOLLEKTOR	COLECTOR
2	07783500	TUBO FLESSIBILE	FLEXIBLE PIPE	TUYAU FLEXIBLE	SCHLAUCH	TUBO FLEXIBLE
3	07783600	TUBO FLESSIBILE	FLEXIBLE PIPE	TUYAU FLEXIBLE	SCHLAUCH	TUBO FLEXIBLE
4	07783300	TUBO FLESSIBILE	FLEXIBLE PIPE	TUYAU FLEXIBLE	SCHLAUCH	TUBO FLEXIBLE
5	07783400	TUBO FLESSIBILE	FLEXIBLE PIPE	TUYAU FLEXIBLE	SCHLAUCH	TUBO FLEXIBLE

-  IMPIANTO IDRAULICO STABILIZZATORI
-  STABILIZERS HYDRAULIC SYSTEM
-  INSTALLATION HYDRAULIQUE STABILISATERS

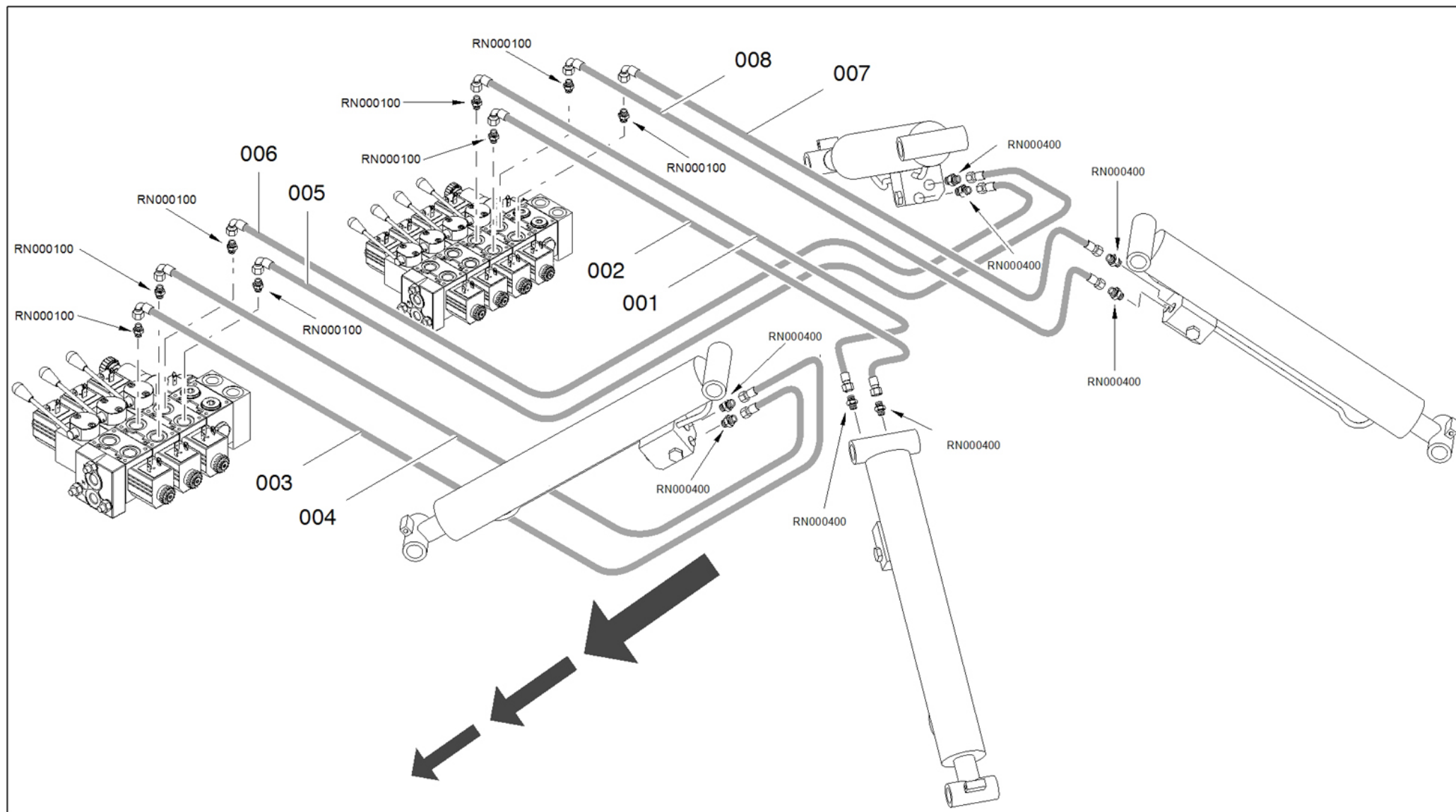
ABSTÜTZUNG ABSTÜTZUNGSHYDRAULIKZYLINDR 
INSTALACIÓN HIDRAULICA ESTABILIZADORS 



Main color codes:  J1 - JLG Cream,  J2 - JLG Orange,  C4 - Green





 IMPIANTO IDRAULICO STABILIZZATORI



 STABILIZERS HYDRAULIC SYSTEM

 INSTALLATION HYDRAULIQUE STABILISATERS

 ABSTÜTZUNG ABSTÜTZUNGSHYDRAULIKZYLIND

 INSTALACIÓN HIDRAULICA ESTABILIZADORS

POS	Codice	 Descrizione	 Description	 Designation	 Benennung	 Descripció
1	07782200	TUBO FLESSIBILE	FLEXIBLE PIPE	TUYAU FLEXIBLE	SCHLAUCH	TUBO FLEXIBLE
2	07782100	TUBO FLESSIBILE	FLEXIBLE PIPE	TUYAU FLEXIBLE	SCHLAUCH	TUBO FLEXIBLE
3	07781700	TUBO FLESSIBILE	FLEXIBLE PIPE	TUYAU FLEXIBLE	SCHLAUCH	TUBO FLEXIBLE
4	07781800	TUBO FLESSIBILE	FLEXIBLE PIPE	TUYAU FLEXIBLE	SCHLAUCH	TUBO FLEXIBLE
5	07781900	TUBO FLESSIBILE	FLEXIBLE PIPE	TUYAU FLEXIBLE	SCHLAUCH	TUBO FLEXIBLE
6	07782000	TUBO FLESSIBILE	FLEXIBLE PIPE	TUYAU FLEXIBLE	SCHLAUCH	TUBO FLEXIBLE
7	07782400	TUBO FLESSIBILE	FLEXIBLE PIPE	TUYAU FLEXIBLE	SCHLAUCH	TUBO FLEXIBLE
8	07782300	TUBO FLESSIBILE	FLEXIBLE PIPE	TUYAU FLEXIBLE	SCHLAUCH	TUBO FLEXIBLE



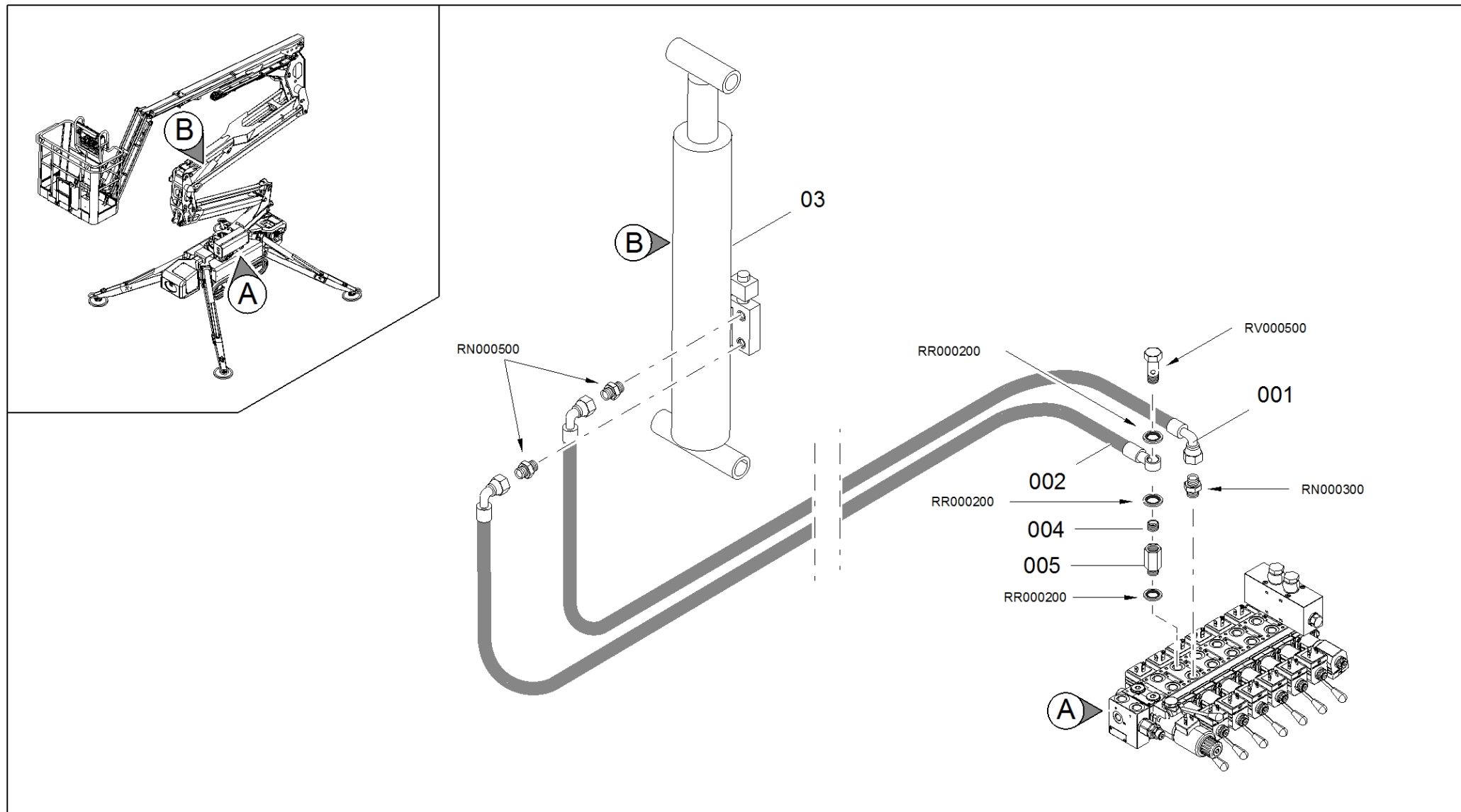

Main color codes:  J1 - JLG Cream,  J2 - JLG Orange,  C4 - Green







 IMPIANTO IDRAULICO 1-2 BRACCI

 1-2 ARMS HYDRAULIC SYSTEM



 SYSTÈME HYDRAULIQUE 1-2 BRAS
HYDRAULIKANLAGE 1-2 ARM INSTALACIÓN HIDRÁULICA 1-2 BRAZOS 

POS	Codice	 Descrizione	 Description	 Designation	 Benennung	 Descripción
1	07784600	TUBO FLESSIBILE	FLEXIBLE PIPE	TUYAU FLEXIBLE	SCHLAUCH	TUBO FLEXIBLE
2	07784700	TUBO FLESSIBILE	FLEXIBLE PIPE	TUYAU FLEXIBLE	SCHLAUCH	TUBO FLEXIBLE
3	277099A3	CILINDRO PRIMO- SECONDO BRACCIO LL1570-X15JP-X430AJ	CYLINDER FIRST- SECOND BOOM LL1570-X15JP-X430AJ	CYLINDER	ZYLINDER	CILINDRO
3	277099H2	CILINDRO PRIMO- SECONDO BRACCIO LL1570-X15JP-X430AJ	CYLINDER FIRST- SECOND BOOM LL1570-X15JP-X430AJ	CYLINDER	ZYLINDER	CILINDRO
4	07688500	PASTIGLIA VNR STROZZATA 3/8 FORO DA Ø=2MM	VALVE	SOUPAPE	VENTIL	VALVULA
5	07688400	RACCORDO PROLUNGA M-F 3/8 H=30 FILETTO UTILE 25	FITTING	RACCORD	ANSCHLUSS	CONEXIÓN

 IMPIANTO IDRAULICO 3 BRACCIO
 3 ARM HYDRAULIC SYSTEM
 SYSTÈME HYDRAULIQUE 3 BRAS

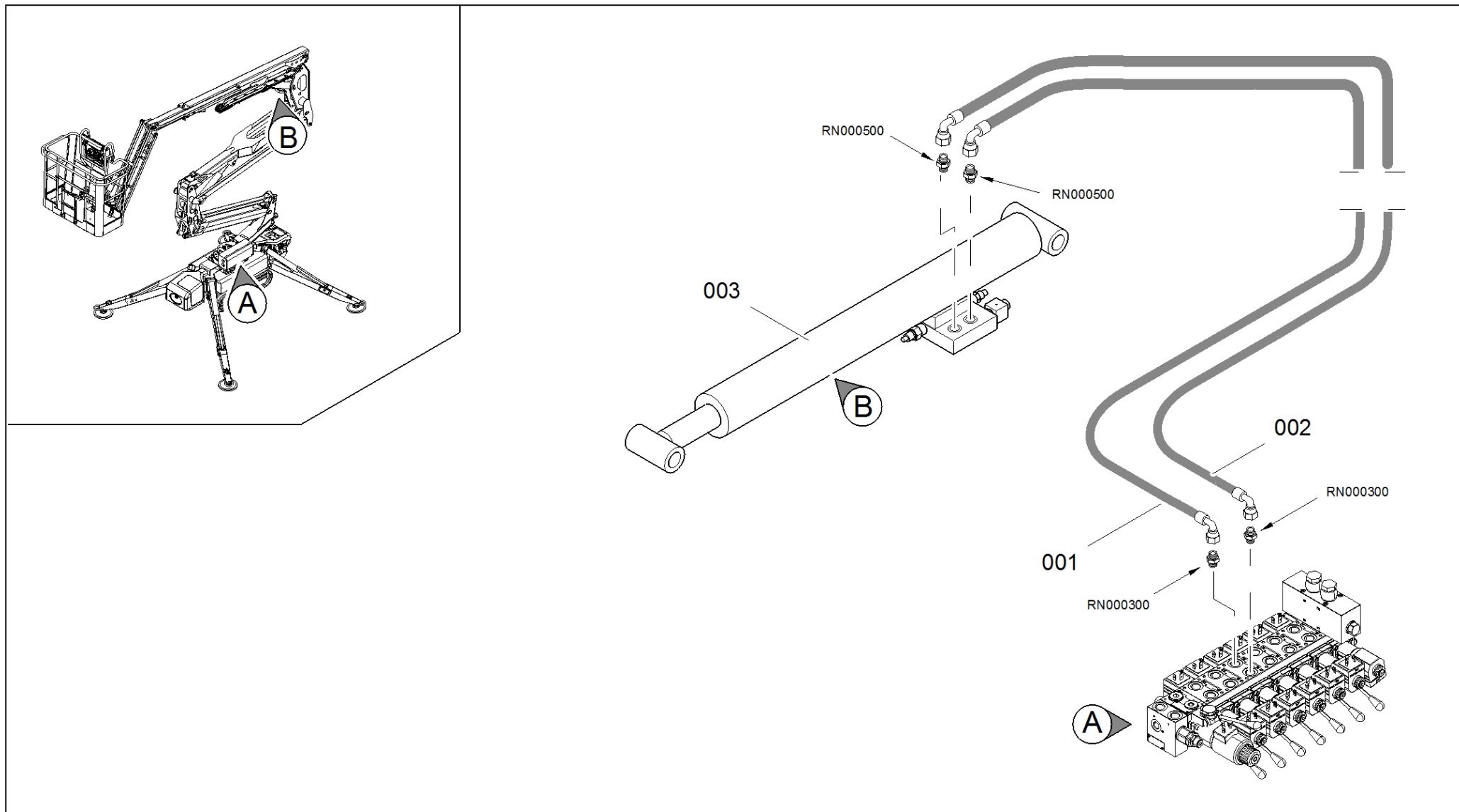
HYDRAULIKANLAGE 3 ARM 
INSTALACIÓN HIDRÁULICA 3 BRAZO 







Main color codes:  J1 - JLG Cream,  J2 - JLG Orange,  C4 - Green

 IMPIANTO IDRAULICO 3 BRACCIO

 3 ARM HYDRAULIC SYSTEM

 SYSTÈME HYDRAULIQUE 3 BRAS
HYDRAULIKANLAGE 3 ARM INSTALACIÓN HIDRÁULICA 3 BRAZO 



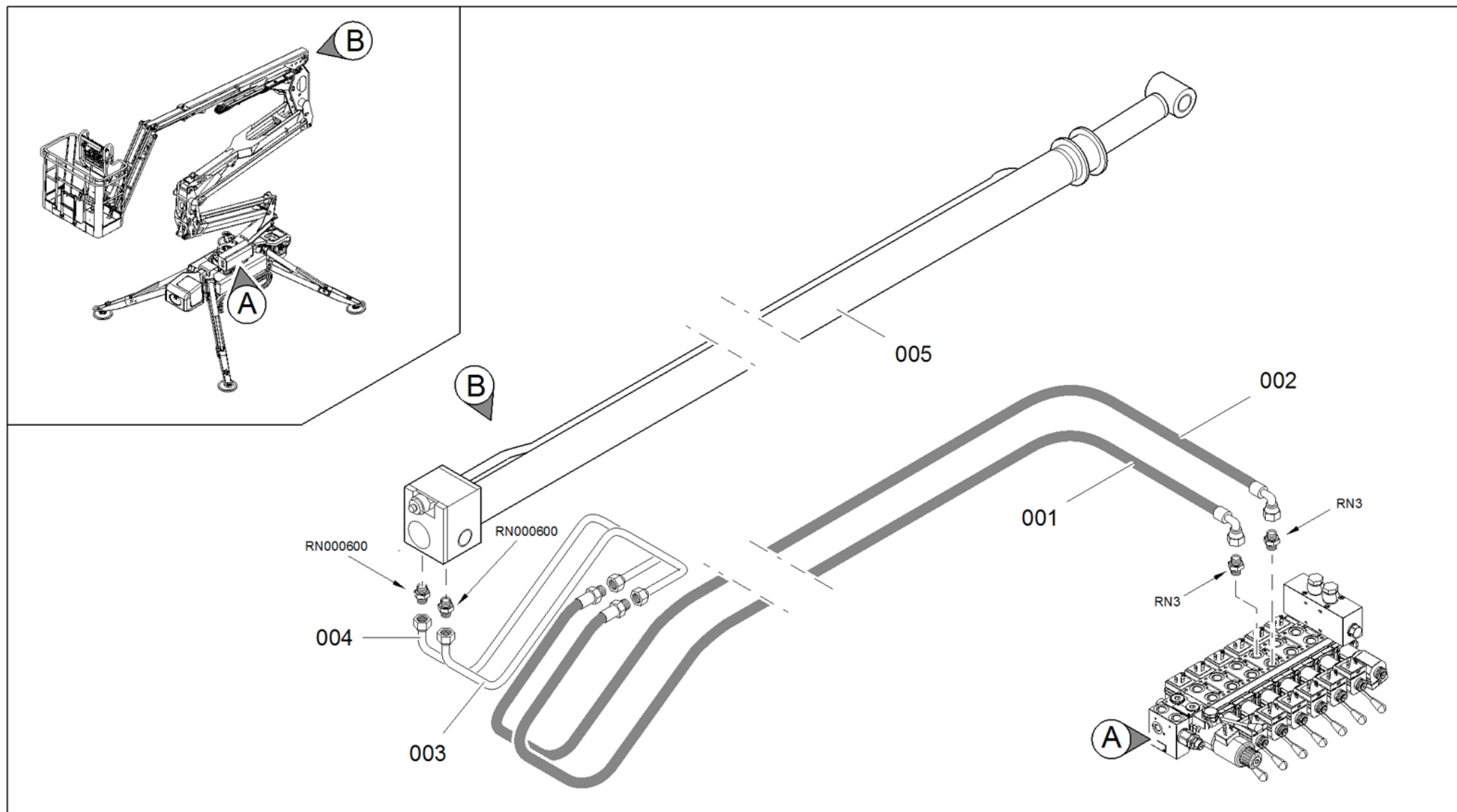

POS	Codice	 Descrizione	 Description	 Designation	 Benennung	 Descripción
1	07785000	TUBO FLESSIBILE	FLEXIBLE PIPE	TUYAU FLEXIBLE	SCHLAUCH	TUBO FLEXIBLE
2	07785100	TUBO FLESSIBILE	FLEXIBLE PIPE	TUYAU FLEXIBLE	SCHLAUCH	TUBO FLEXIBLE
3	277100A3	CILINDRO TERZO BRACCIO LL1570-X15JP-X430AJ	THIRD CYLINDER BOOM LL1570-X15JP-X430AJ	CYLINDRE TROISIÈME BRAS	ZYLINDER DRITTER ARM	CILINDRO TERCERO BRAZO
3	277100H2	CILINDRO TERZO BRACCIO LL1570-X15JP-X430AJ	THIRD CYLINDER BOOM LL1570-X15JP-X430AJ	CYLINDRE TROISIÈME BRAS	ZYLINDER DRITTER ARM	CILINDRO TERCERO BRAZO







 IMPIANTO IDRAULICO SFILO

 TELESCOPIC HYDRAULIC SYSTEM



 TELESCOPIQUE HIDRAULIQUE
TELESKOPHYDRAULIK INSTALACIÓN EXTENSIÓN HIDRÁULICA 

POS	Codice	 Descrizione	 Description	 Designation	 Benennung	 Descripción
1	07785200	TUBO FLESSIBILE	FLEXIBLE PIPE	TUYAU FLEXIBLE	SCHLAUCH	TUBO FLEXIBLE
2	07785300	TUBO FLESSIBILE	FLEXIBLE PIPE	TUYAU FLEXIBLE	SCHLAUCH	TUBO FLEXIBLE
3	07753700	TUBO RIGIDO	RIGID PIPE	TUYAU	SCHLAUCH	TUBO
4	07753800	TUBO RIGIDO	RIGID PIPE	TUYAU	SCHLAUCH	TUBO
5	277101H2	CILINDRO SFILO LL1570	CYLINDER EXTENSION LL1570	CYLINDRE	ZYLINDER	CILINDRO



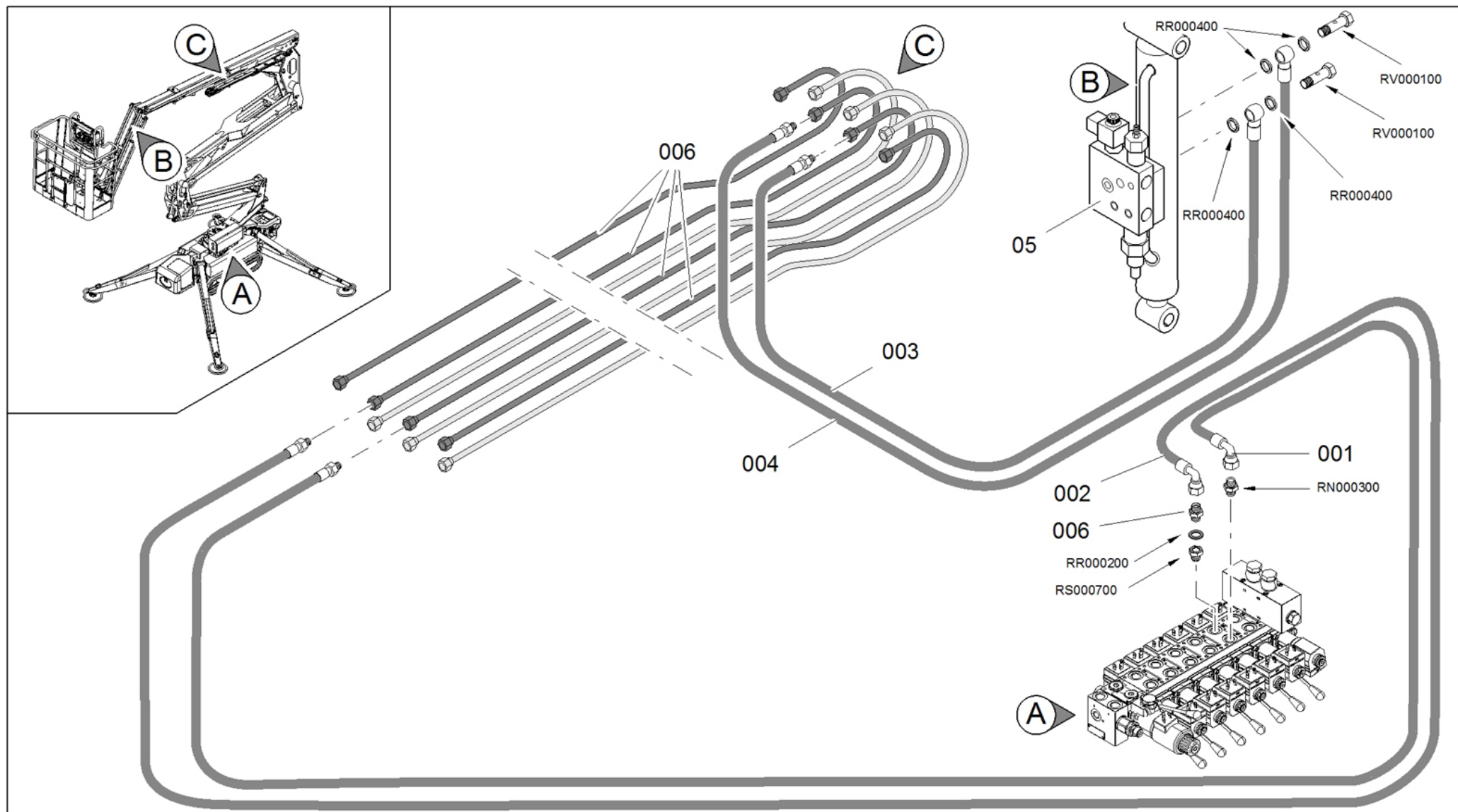

 IMPIANTO JIB
 JIB HYDRAULIC SYSTEM
 SYSTÈME HYDRAULIQUE JIB



ZYLINDER JIB ARM 
 INSTALACIÓN HIDRÁULICA JIB 







Main color codes:  **J1** - JLG Cream,  **J2** - JLG Orange,  **C4** - Green

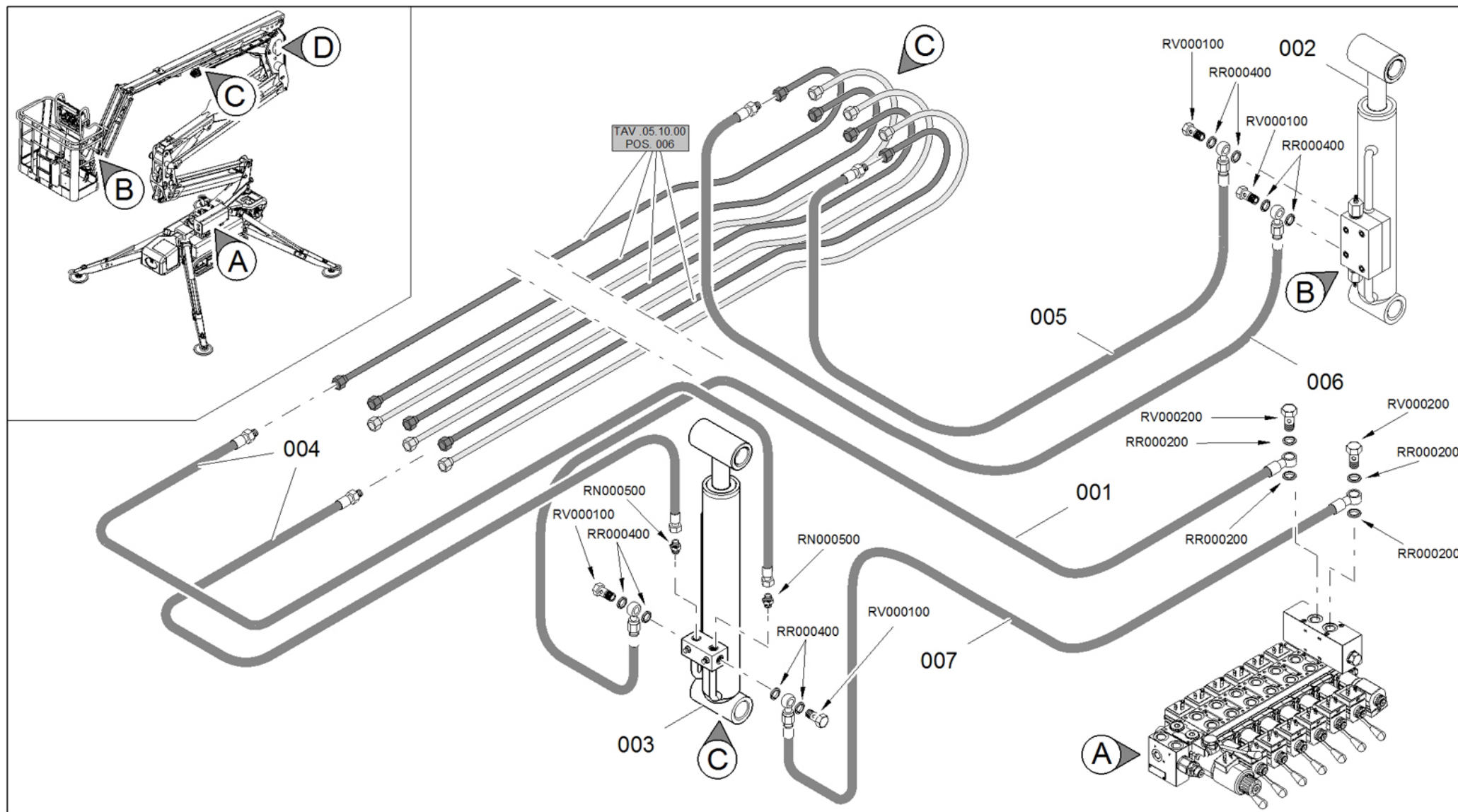

 IMPIANTO JIB JIB HYDRAULIC SYSTEM SYSTÈME HYDRAULIQUE JIBZYLINDER JIB ARM INSTALACIÓN HIDRÁULICA JIB 





POS	Codice	 Descrizione	 Description	 Designation	 Benennung	 Descripción
1	07785700	TUBO FLESSIBILE	FLEXIBLE PIPE	TUYAU FLEXIBLE	SCHLAUCH	TUBO FLEXIBLE
2	07785600	TUBO FLESSIBILE	FLEXIBLE PIPE	TUYAU FLEXIBLE	SCHLAUCH	TUBO FLEXIBLE
3	07786400	TUBO FLESSIBILE	FLEXIBLE PIPE	TUYAU FLEXIBLE	SCHLAUCH	TUBO FLEXIBLE
4	07786300	TUBO FLESSIBILE	FLEXIBLE PIPE	TUYAU FLEXIBLE	SCHLAUCH	TUBO FLEXIBLE
5	270695A3	CILINDRO SFILO	EXTENSION CYLINDER	CYLINDRE SECT.TÉLESCOP.	TELESKOPZYLINDER	CIL. BRAZO TELESCÓP.
5	270695H2	CILINDRO JIB	JIB CYLINDER	CYLINDRE JIB	KORBARMZYLINDER	CILINDRO JIB
6	07753900	TUBO RIGIDO	RIGID PIPE	TUYAU	SCHLAUCH	TUBO



Main color codes:  J1 - JLG Cream,  J2 - JLG Orange,  C4 - Green







 IMPIANTO IDRAULICO LIVELLAMENTO
 LEVELING CYLINDERS HYDRAULIC SYSTEM
 SYSTÈME HYDRAULIQUE CYLINDRES BRAS

HYDRAULIKANLAGE ZYLINDER ARM 
 INSTALACIÓN HIDRÁULICA CILINDROS BRAZOS 



POS	Codice	 Descrizione	 Description	 Designation	 Benennung	 Descripción
1	07784900	TUBO FLESSIBILE	FLEXIBLE PIPE	TUYAU FLEXIBLE	SCHLAUCH	TUBO FLEXIBLE
2	273151A3	CILINDRO LIVELLAMENTO CESTO SU CESTO	CYLINDER LEVEL BASKET ON BASKET	CYLINDRE SUR LEVEL BASKET BASKET	ZYLINDER AUF LEVEL WARENKORB WARENKORB	CILINDRO DE NIVEL DE BASKET BASKET
2	273151H2	CILINDRO LIVELLAMENTO CESTO SU CESTO	LEVELING CYLINDER BASKET ON BASKET	CYLINDRE NIVELLEMENT PANIER SUR PANIER	ZYLINDER KORBNIVELLIERUNG	CILINDRO NIVELACIÓN CESTA
3	270693A3	CILINDRO SFILO	EXTENSION CYLINDER	CYLINDRE SECT.TÉLESCOP.	TELESKOPZYLINDER	CIL. BRAZO TELESCÓP.
3	270693H2	CILINDRO LIVELLAMENTO CESTO	BASKET LEVELLING CYLINDER	CYLINDRE NIVELLEMENT PANIER	ZYLINDER KORBNIVELLIERUNG	CILINDRO NIVELACIÓN CESTA
4	07786000	TUBO FLESSIBILE	FLEXIBLE PIPE	TUYAU FLEXIBLE	SCHLAUCH	TUBO FLEXIBLE
5	07786200	TUBO FLESSIBILE	FLEXIBLE PIPE	TUYAU FLEXIBLE	SCHLAUCH	TUBO FLEXIBLE
6	07786100	TUBO FLESSIBILE	FLEXIBLE PIPE	TUYAU FLEXIBLE	SCHLAUCH	TUBO FLEXIBLE
7	07784800	TUBO FLESSIBILE	FLEXIBLE PIPE	TUYAU FLEXIBLE	SCHLAUCH	TUBO FLEXIBLE

Main color codes:  J1 - JLG Cream,  J2 - JLG Orange,  C4 - Green

 IMPIANTO IDRAULICO ROTAZIONE CESTO
 CAGE ROTATION HYDRAULIC SYSTEM
 SYSTÈME HYDRAULIQUE ROTATION PANIER

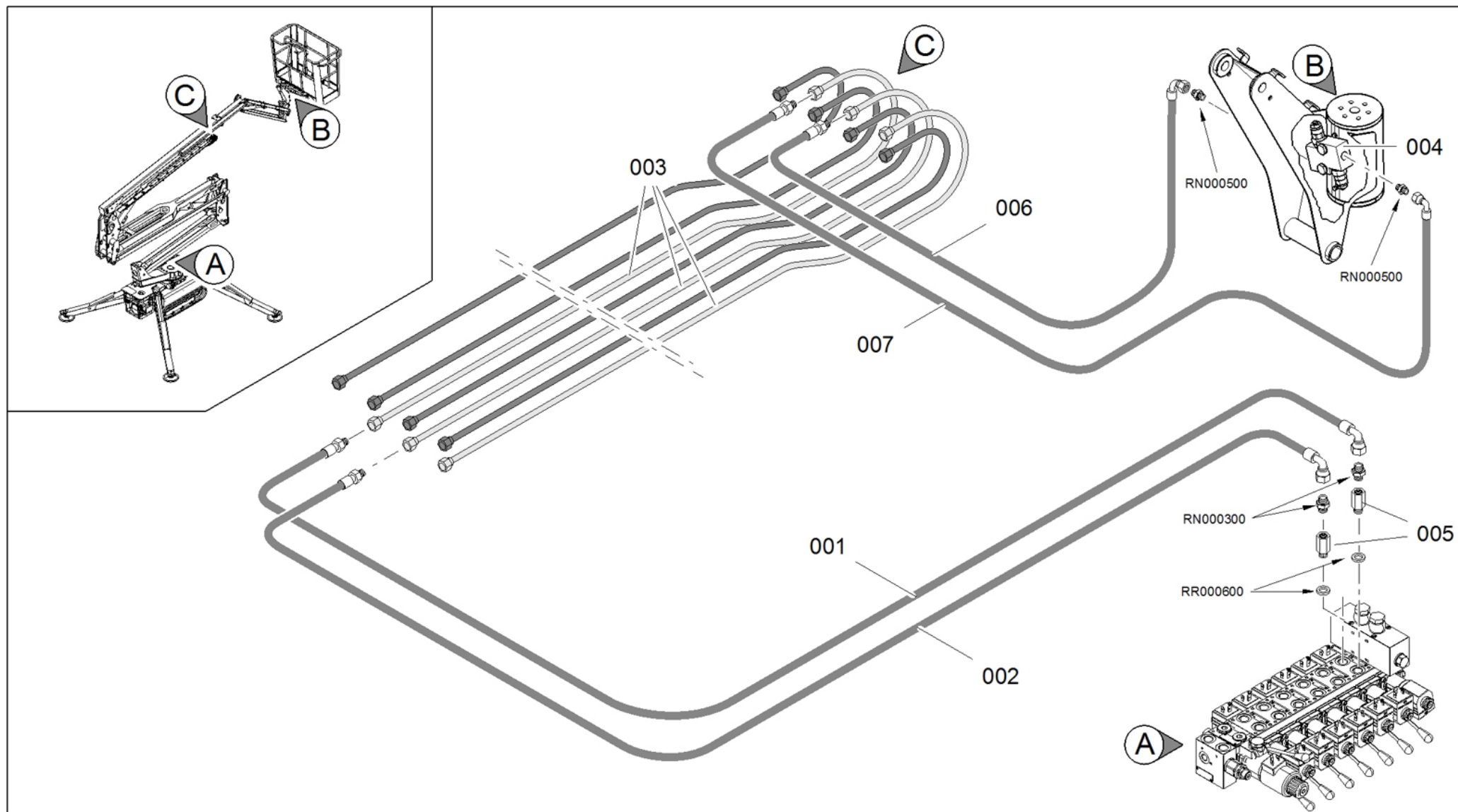
HYDRAULIKANLAGE KORBSCHWENKUNG 
 INSTALACIÓN HIDRÁULICA ROTACIÓN CESTA 









Main color codes:  J1 - JLG Cream,  J2 - JLG Orange,  C4 - Green

 IMPIANTO IDRAULICO ROTAZIONE CESTO

 CAGE ROTATION HYDRAULIC SYSTEM

 SYSTÈME HYDRAULIQUE ROTATION PANIER

 HYDRAULIKANLAGE KORBSCHWENKUNG 
 INSTALACIÓN HIDRÁULICA ROTACIÓN CESTA 

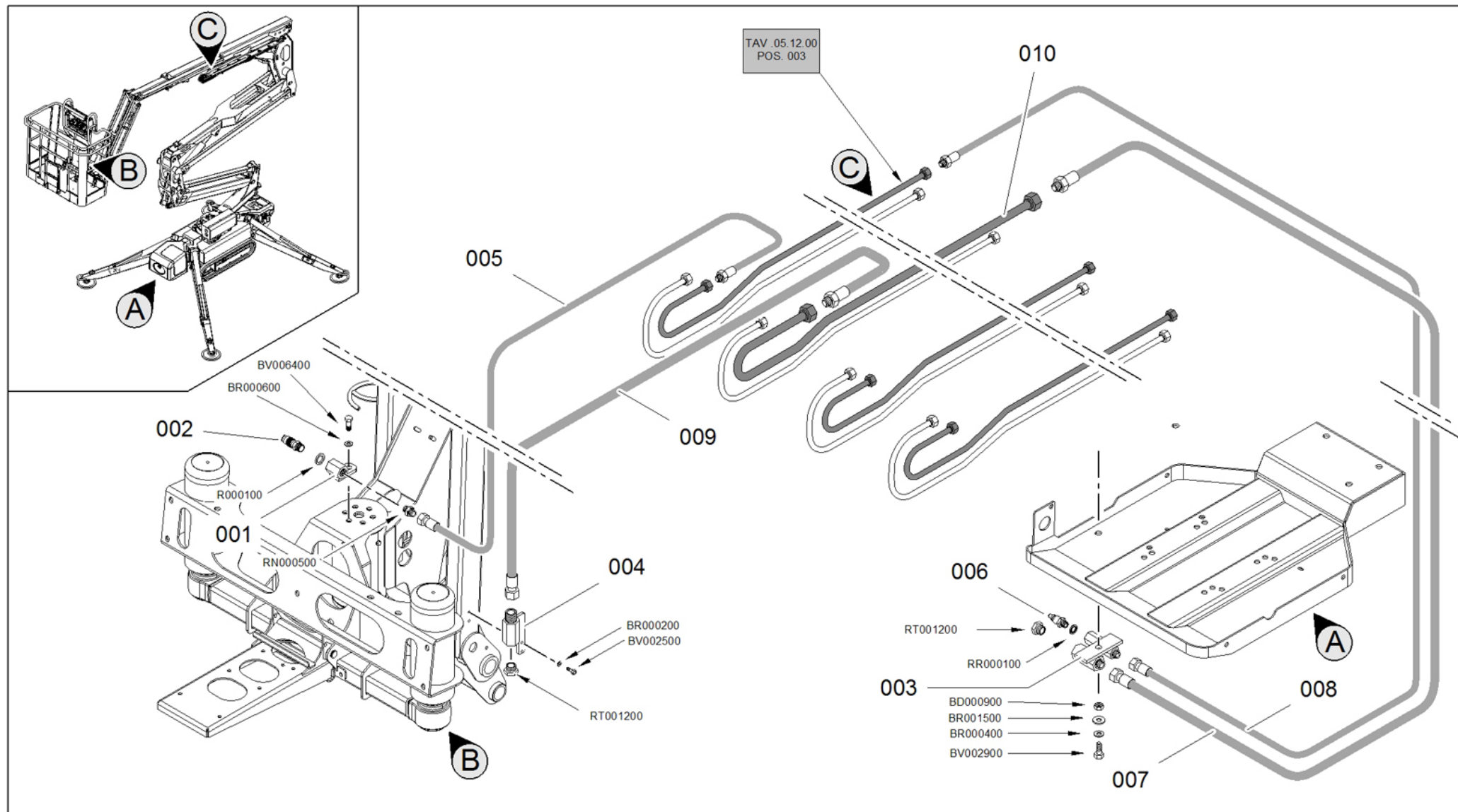

POS	Codice	 Descrizione	 Description	 Designation	 Benennung	 Descripción
1	07785800	TUBO FLESSIBILE	FLEXIBLE PIPE	TUYAU FLEXIBLE	SCHLAUCH	TUBO FLEXIBLE
2	07785900	TUBO FLESSIBILE	FLEXIBLE PIPE	TUYAU FLEXIBLE	SCHLAUCH	TUBO FLEXIBLE
3	07754000	TUBO RIGIDO	RIGID PIPE	TUYAU	SCHLAUCH	TUBO
4	2648910001	VALVOLA IDRAULICA	HYDRAULIC VALVE	VALVE HYDRAULIQUE	HYDRAULIKVENTIL	VÁLVULA HIDRÁULICA
5	03149500	RACCORDO A COLONNA 3/8" H=20	EXTENSION 3/8" H=20	RACCORD	ANSCHLUSS	CONEXIÓN
6	07786500	TUBO FLESSIBILE	FLEXIBLE PIPE	TUYAU FLEXIBLE	SCHLAUCH	TUBO FLEXIBLE
7	07786600	TUBO FLESSIBILE	FLEXIBLE PIPE	TUYAU FLEXIBLE	SCHLAUCH	TUBO FLEXIBLE







 IMPIANTO IDRAULICO ARIA COMPRESSA



 COMPRESSED AIR HYDRAULIC SYSTEM

 SYSTÈME HYDRAULIQUE AIR COMPRIMÉ



 HYDRAULIKANLAGE DRUCKLUFT 
 INSTALACIÓN HIDRÁULICA AIRE COMPRIMIDO 

POS	Codice	 Descrizione	 Description	 Designation	 Benennung	 Descripción
1	04845100	SUPPORTO	SUPPORT	SUPPORT	HALTERUNG	SOPORTE
2	05509900	INNESTO RAPIDO	QUICK COUPLING	RACCORD RAPIDE	SCHNELLKUPPLUNG	CONEXIÓN RÁPIDA
3	07611000	RACCORDO	PIPE FITTING	TUYAU	ANSCHLUSS	MANGUITO
4	07611100	RACCORDO	HOSE FITTING	TUYAU	ANSCHLUSS	CONEXIÓN
5	07786700	TUBO FLESSIBILE	FLEXIBLE PIPE	TUYAU FLEXIBLE	SCHLAUCH	TUBO FLEXIBLE
6	05580200	RUBINETTO	FAUCET	ROBINET	WASSERHAHN	GRIFO
7	07785400	TUBO FLESSIBILE	FLEXIBLE PIPE	TUYAU FLEXIBLE	SCHLAUCH	TUBO FLEXIBLE
8	07785500	TUBO FLESSIBILE	FLEXIBLE PIPE	TUYAU FLEXIBLE	SCHLAUCH	TUBO FLEXIBLE
9	07786800	TUBO FLESSIBILE	FLEXIBLE PIPE	TUYAU FLEXIBLE	SCHLAUCH	TUBO FLEXIBLE
10	07754100	TUBO RIGIDO	RIGID PIPE	TUYAU	SCHLAUCH	TUBO

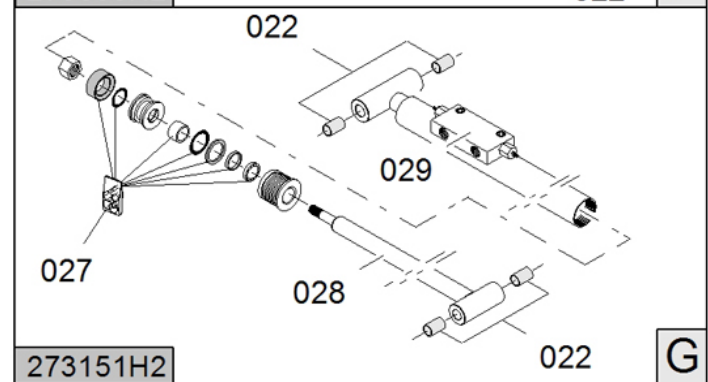
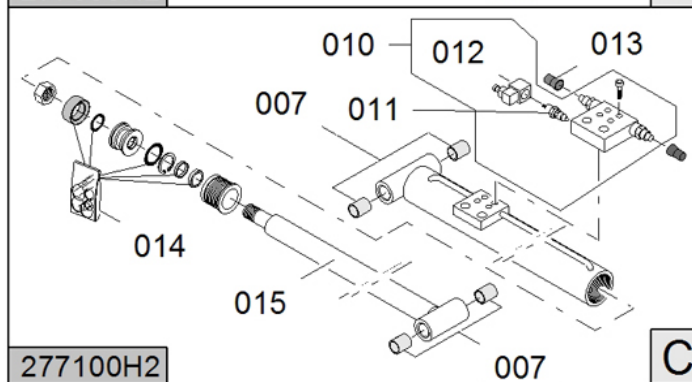
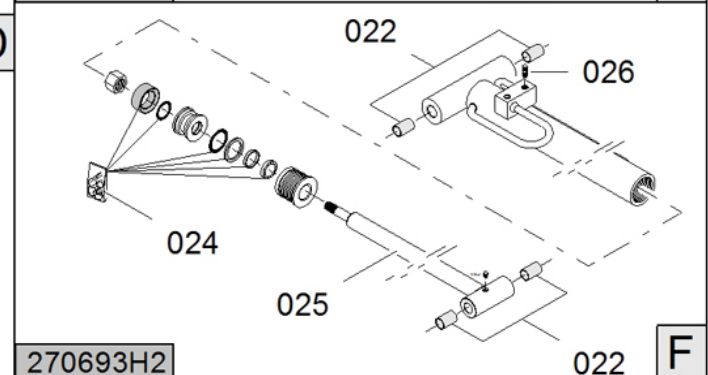
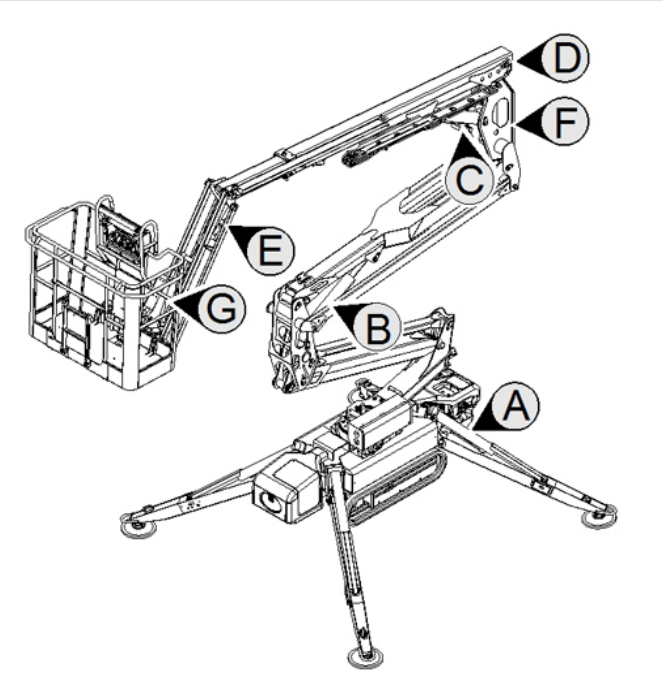
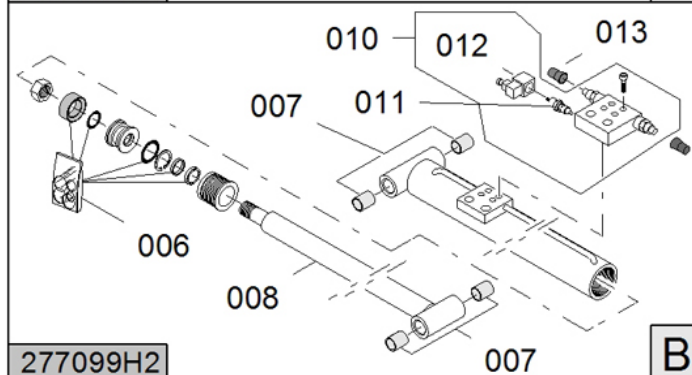
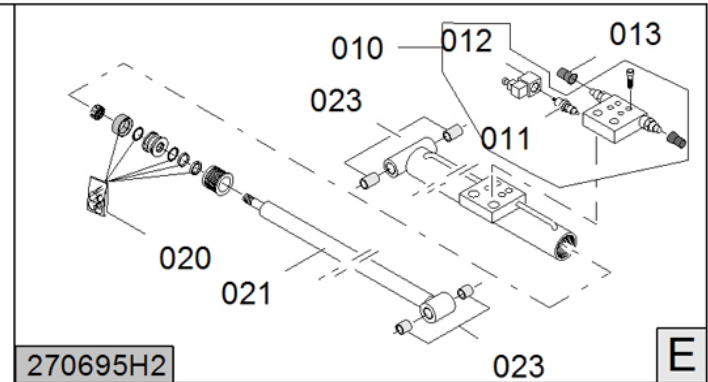
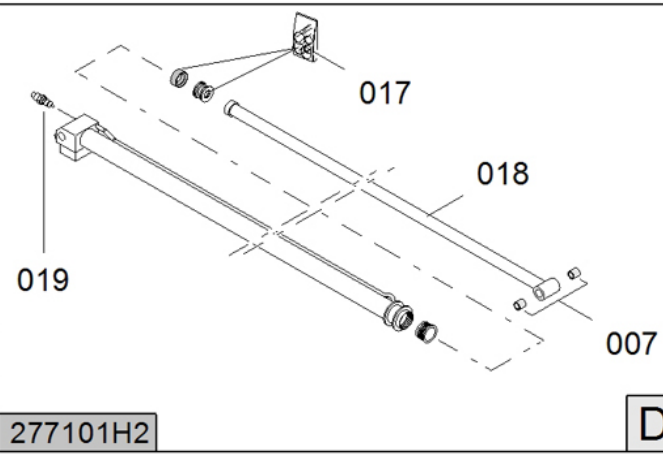
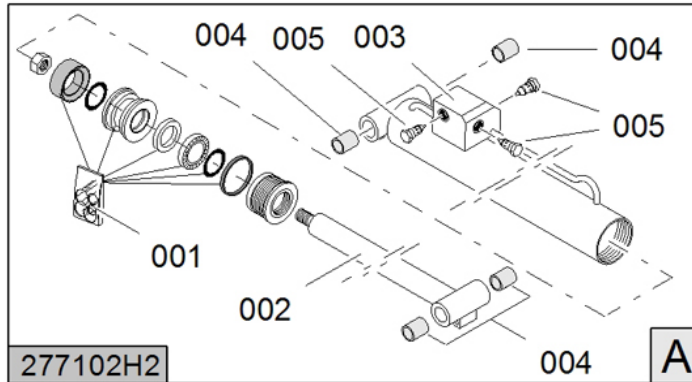

 CILINDRI
 CYLINDERS
 CYLINDRES





ZYLINDER 
 CILINDROS 





Main color codes:  J1 - JLG Cream,  J2 - JLG Orange,  C4 - Green



 CILINDRI
 CYLINDERS
 CYLINDRES





ZYLINDER 
 CILINDROS 



POS	Codice	 Descrizione	 Description	 Designation	 Benennung	 Descripción
1	2827490002	KIT GUARNIZIONI CILINDRO BRACCIO 1 LL1570-X15JP-X430AJ	SEAL KIT CYLINDER FIRST BOOM LL1570- X15JP-X430AJ	KIT JOINTS	DICHTUNGSSATZ	KIT JUNTAS
2	282209H201	STELO CILINDRO STABILIZZATORE	ROD CYLINDER STABILIZER	TIGE VÉRIN STABILISATEUR	STÜTZFUßZYLINDER KOLBENSTANGE	VÁSTAGO CILINDRO ESTABILIZADOR
3	2705540002	BLOCCHETTO	BLOCK	BLOC	BLOCK	BLOQUE
4	07765500	BOCCOLA	BUSH	DOUILLE	BUCHSE	CASQUILLO
5	1541150011	VALVOLA IDRAULICA	HYDRAULIC VALVE	VALVE HYDRAULIQUE	HYDRAULIKVENTIL	VÁLVULA HIDRÁULICA
6	2770990002	KIT GUARNIZIONI CILINDRO BRACCIO 1 LL1570-X15JP-X430AJ	SEAL KIT CYLINDER FIRST BOOM LL1570- X15JP-X430AJ	KIT JOINTS	DICHTUNGSSATZ	KIT JUNTAS
7	06586000	BOCCOLA	BUSH	BAGUE	BUCHSE	CASQUILLO
8	2770990001	STELO CILINDRO BRACCIO 1 LL1570- X15JP-X430AJ	ROD CYLINDER FIRST BOOM LL1570-X15JP- X430AJ	TIGE CYLINDER	ZYLINDERSCHAFT	VÁSTAGO CILINDRO
10	26119300	VALVOLA IDRAULICA	HYDRAULIC VALVE	VALVE HYDRAULIQUE	HYDRAULIKVENTIL	VÁLVULA HIDRÁULICA
11	0552550001	ELETTROVALVOLA	SOLENOID VALVE	ÉLECTROVANNE	MAGNETVENTIL	ELECTROVÁLVULA
12	0552550003	BOBINA	COIL	BOBINE	SPULE	BOBINA
13	05576200	PROTEZIONE	PROTECTION	PROTECTION	SCHUTZ	PROTECCIÓN
14	2771000002	KIT GUARNIZIONI CILINDRO BRACCIO 3 LL1570-X15JP-X430AJ	SEAL KIT CYLINDER THIRD BOOM LL1570- X15JP-X430AJ	KIT JOINTS	DICHTUNGSSATZ	KIT JUNTAS
15	2706920003	SENSORE LINEARE CILINDRO	CYLINDER LINEAR SENSOR	CAPTEUR	SENSOR	SENSOR
15	2771000001	STELO CILINDRO BRACCIO 3 LL1570- X15JP-X430AJ	ROD CYLINDER THIRD BOOM LL1570- X15JP-X430AJ	TIGE CYLINDRE	ZYLINDERSCHAFT	VÁSTAGO CILINDRO
17	2771010002	KIT GUARNIZIONI CILINDRO SFILO LL1570-X15JP-X430AJ	SEAL KIT CYLINDER SFILO LL1570-X15JP- X430AJ	KIT JOINTS	DICHTUNGSSATZ	KIT JUNTAS

Main color codes:  J1 - JLG Cream,  J2 - JLG Orange,  C4 - Green

 CILINDRI
 CYLINDERS
 CYLINDRES

ZYLINDER 
 CILINDROS 

POS	Codice	 Descrizione	 Description	 Designation	 Benennung	 Descripción
18	2771010001	STELO CILINDRO SFILO LL1570-X15JP- X430AJ	ROD CYLINDER SFILO LL1570-X15JP-X430AJ	TIGE CYLINDRE	ZYLINDERSCHAFT	VÁSTAGO CILINDRO
19	2630690003	VALVOLA IDRAULICA	HYDRAULIC VALVE	VALVE HYDRAULIQUE	HYDRAULIKVENTIL	VÁLVULA HIDRÁULICA
20	2706950001	KIT GUARNIZIONI CILINDRO JIB	SEAL KIT CYLINDER JIB	KIT DE JOINTS	DICHTUNGSSATZ	KIT JUNTAS CILINDRO JIB
21	2706950002	STELO CILINDRO JIB	ROD CYLINDER JIB	TIGE DE CYLINDRE JIB	KORBARM ZYLINDERSCHAFT	VASTAGO CILINDRO JIB
22	2627890006	BOCCOLA	BUSH	DOUILLE	BUCHSE	CASQUILLO
23	2627910006	BOCCOLA	BUSH	DOUILLE	BUCHSE	CASQUILLO
24	2706930001	KIT GUARNIZIONI CILINDRO LIVELLAMENTO SU RINVIO	CYLINDER GASKET KIT	KIT DE JOINTS CYLINDRE NIVELLEMENT	DICHTSATZ ZYLINDER AUSNIVELLIERUNG	KIT DE JUNTAS CILINDRO NIVELACIÓN
25	2706930002	STELO CILINDRO LIVELLAMENTO SU RINVIO	ROD CYLINDER	TIGE CYLINDRE	ZYLINDERSCHAFT	VASTAGO CILINDRO
26	2588290008	VITE	SCREW	VIS	SCHRAUBE	TORNILLO
27	2706940001	KIT GUARNIZIONI CILINDRO LIVELLAMENTO SU CESTO	CYLINDER GASKET KIT	KIT DE JOINTS CYLINDRE NIVELLEMENT	DICHTSATZ	KIT JUNTAS
28	2706940002	STELO CILINDRO LIVELLAMENTO SU CESTO	BASKET LEVELING CYLINDER ROD ON BASKET	CYLINDRE TIGE	ZYLINDERSCHAFT	VASTAGO CILINDRO
29	2731510003	VALVOLA IDRAULICA	HYDRAULIC VALVE	VALVE HYDRAULIQUE	HYDRAULIKVENTIL	VÁLVULA HIDRÁULICA

 COMPONENTI IMPIANTO ELETTRICO
 ELECTRICAL SYSTEM COMPONENTS
 COMPOSANTS INSTALLATION ÉLECTRIQUE

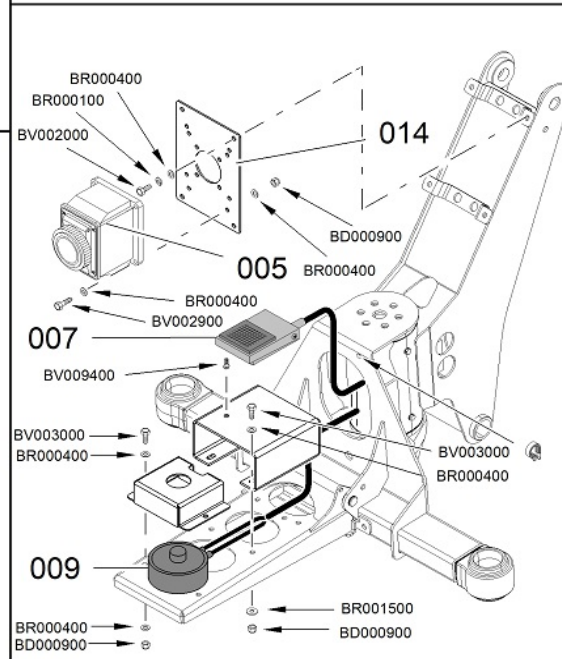
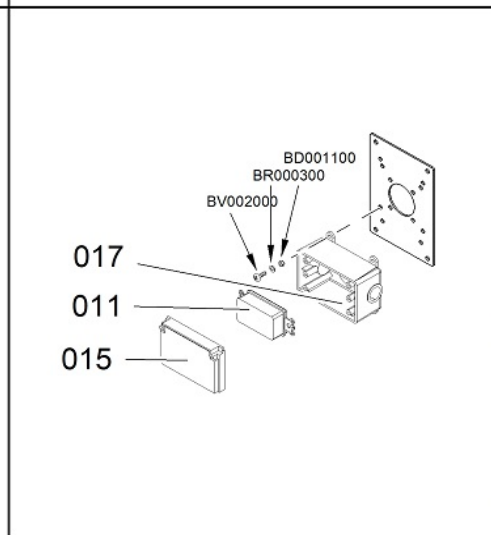
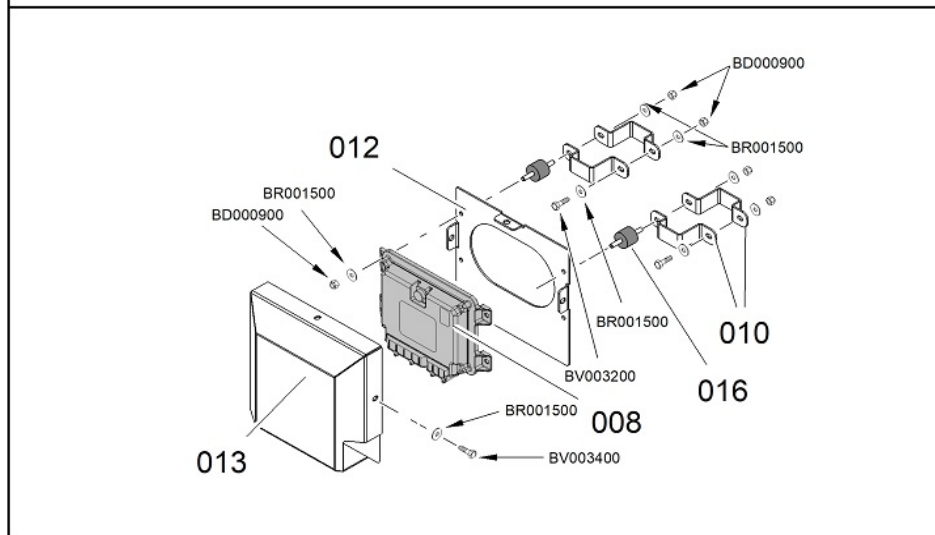
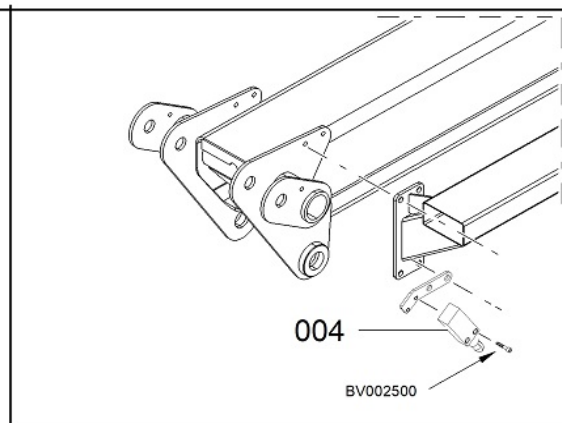
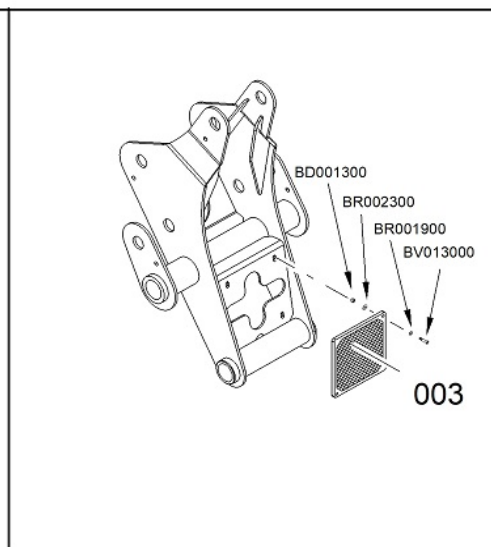
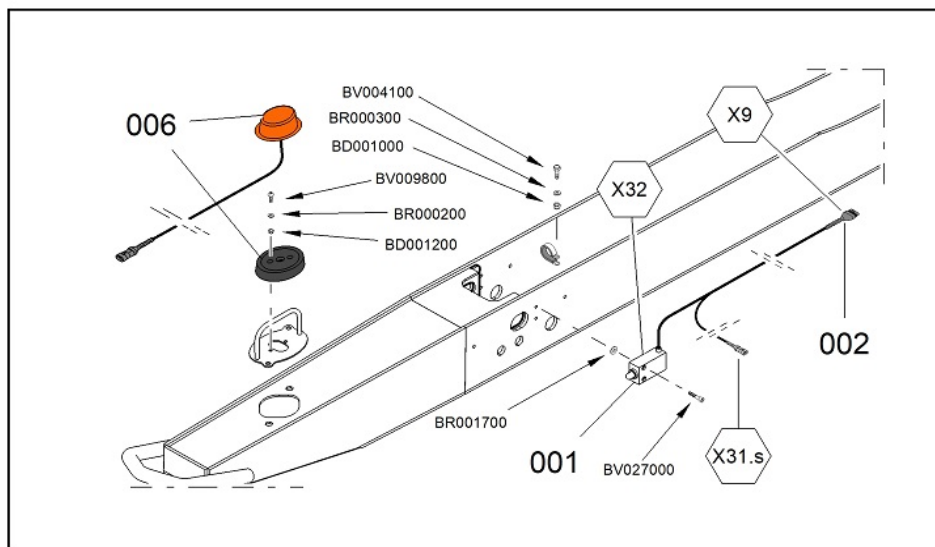

KOMPONENTEN ELEKTROANLAGE 
 COMPONENTES INSTALACIÓN ELÉCTRICA 











 COMPONENTI IMPIANTO ELETTRICO

 ELECTRICAL SYSTEM COMPONENTS

 COMPOSANTS INSTALLATION ÉLECTRIQUE

 KOMponenten Elektroanlage 
 Componentes Instalación Eléctrica 



POS	Codice	 Descrizione	 Description	 Designation	 Benennung	 Descripción
1	1772950011	MICROINTERRUTTOR E 2 CONTATTI NC/NO TESTINA PULSANTE CAVO LUNGO 2 METRI	MICRO SWITCH CONTACT 2 NC / NO BUTTON HEAD CABLE 2 METER	MICROINTERRUPTEU R	MIKROSCHALTER	MICROINTERRUPTOR
2	1772950012	CAVO PROLUNGA STABILIZZATORE LL1570-X15JP-X430AJ	EXTENSION CABLE STABILIZER LL1570- X15JP-X430AJ	CÂBLE	KABEL	CABLE
3	1679890001	CATARIFRANGENTE 100X100 MM	REFLECTOR 100X100 MM	CATADIOPTRE	REFLEKTOR	CATADIÓPTRICO
4	1679900012	MICROINTERRUTTOR E 2 CONTATTI NC/NO TESTINA ROTELLA ACCIAIO CAVO LUNGO 5 METRI	MICRO SWITCH CONTACT 2 NC / NO HEAD STEEL WHEEL LONG CABLE 5 METER	MICROINTERRUPTEU R	MIKROSCHALTER	MICROINTERRUPTOR
5	1585570005	PRESA ELETTRICA 230V	ELECTRICAL SOCKET 230V	PRISE ÉLECTRIQUE	STECKDOSE	ENCHUFE ELÉCTRICO
5	1591700002	PRESA ELETTRICA 110V	ELECTRICAL SOCKET 110V	PRISE ÉLECTRIQUE 110V	STECKDOSE 110V	ENCHUFE ELÉCTRICO 110V
6	1757250023	SPIA STABILIZZATORE LED COMPLETA DI CONNETTORE	LED LIGHT	TEMOIN LED	KONTROLLAMPE	INDICADOR LED
7	1772950015	INTERRUTTORE A PEDALE COMPLETO DI CAVO E CONNETTORE TRE VIE CONTATTO NC/NO	FOOT SWITCH COMPLETE WITH CABLE AND CONNECTOR THREE- WAY CONTACT NC/NO	INTERRUPTEUR	SCHALTER	INTERRUPTOR





 Main color codes:  J1 - JLG Cream,  J2 - JLG Orange,  C4 - Green



 COMPONENTI IMPIANTO ELETTRICO

 ELECTRICAL SYSTEM COMPONENTS

 COMPOSANTS INSTALLATION ÉLECTRIQUE

 KOMponenten Elektroanlage 
 Componentes Instalación Eléctrica 

POS	Codice	 Descrizione	 Description	 Designation	 Benennung	 Descripción
8	1772950016	SCHEDE 48XS CON BOOTLOADER 1.2.0, VERSIONE SOFTWARE PER MACCHINE CE E ANSI CON MOTORE TERMICO E LITIO	X48S BOARD WITH BOOTLOADER 1.2.0, SOFTWARE VERSION FOR CE AND ANSI MARKET WITH ENGINE THERMIC AND LITIO	CARTE ÉLECTRONIQUE	ELEKTRONISCHE PLATINE	TARJETA ELECTRÓNICA
9	17669800	SENSORE CELLA DI CARICO 4-20MA COMPLETO DI CAVO E CONNETTORI M12 (MK2)	SENSOR LOAD CELL 4-20MA WITH CABLE AND CONNECTORS M12 (MK2 VERSION)	CELLULE DE CHARGE (MK2)	MESSDOSE (MK2)	CÉLULA DE CARGA (MK2)
10	077090A6	COLLARE FISSAGGIO SCHEDE CELLA DI CARICO TTC	COLLAR FIXING SHEET LOAD CELL TTC	BRIDE	BUNDRING	ABRAZADERA
10	077090H2	COLLARE FISSAGGIO SCHEDE CELLA DI CARICO TTC	COLLAR FIXING SHEET LOAD CELL TTC	BRIDE	BUNDRING	ABRAZADERA
11	27073700	BOX PRESE USA AL CESTO, RECEPTACLE PART N°:0861731	US SOCKET BOX TO BASKET, RECEPTACLE PART N°:0861731	BOX PRISES	SCHACHTEL STECKDOSEN	CAJA ENCHUFES
12	077091A6	PIASTRA FISSAGGIO SCHEDE CELLA DI CARICO TTC	FIXING PLATE LOAD CELL CARD TTC	PLAQUE	PLATTE	PLACA
12	077091H2	PIASTRA FISSAGGIO SCHEDE CELLA DI CARICO TTC	FIXING PLATE LOAD CELL CARD TTC	PLAQUE	PLATTE	PLACA
13	077712A6	CARTER PROTEZIONE SCHEDE CELLA DI CARICO TTC	CARTER PROTECTION CELL CARD LOAD TTC	CARTER	KURBELGEHÄUSE	CÁRTER
13	077712H2	CARTER PROTEZIONE SCHEDE CELLA DI CARICO TTC	CARTER PROTECTION CELL CARD LOAD TTC	CARTER	KURBELGEHÄUSE	CÁRTER





 Main color codes:  J1 - JLG Cream,  J2 - JLG Orange,  C4 - Green



 COMPONENTI IMPIANTO ELETTRICO

 ELECTRICAL SYSTEM COMPONENTS

 COMPOSANTS INSTALLATION ÉLECTRIQUE



 KOMponenten Elektroanlage 
 Componentes Instalación Eléctrica 

POS	Codice	 Descrizione	 Description	 Designation	 Benennung	 Descripción
14	077089A6	PIASTRA FISSAGGIO PRESE SU CESTO TTC	FIXING PLATE PLUGS ON BASKET TTC	PLAQUE	PLATTE	PLACA
14	077089H2	PIASTRA FISSAGGIO PRESE SU CESTO TTC	FIXING PLATE PLUGS ON BASKET TTC	PLAQUE	PLATTE	PLACA
15	27073800	COVER PRESE USA AL CESTO, RECEPTACLE BOX PART N°:1671207	COVER US SOCKETS TO BASKET, RECEPTACLE BOX PART N°:1671207	PRETECTION	SCHUTZ	PROTECCIÓN
16	04152300	SUPPORTO ELASTICO SUPERIORE RADIATORE -	SPRING SUPPORT	SUPPORT ELASTIQUE	FEDERAUFLAGE	SOPORTE ELASTICO
16	27073900	PLUG PRESE USA AL CESTO, RECEPTACLE PART N°:4460346	US SOCKETS TO BASKET, RECEPTACLE PART N°:4460346	PRISE	STECKDOSE	ENCHUFE

 COMPONENTI IMPIANTO ELETTRICO
 ELECTRICAL SYSTEM COMPONENTS
 COMPOSANTS INSTALLATION ÉLECTRIQUE

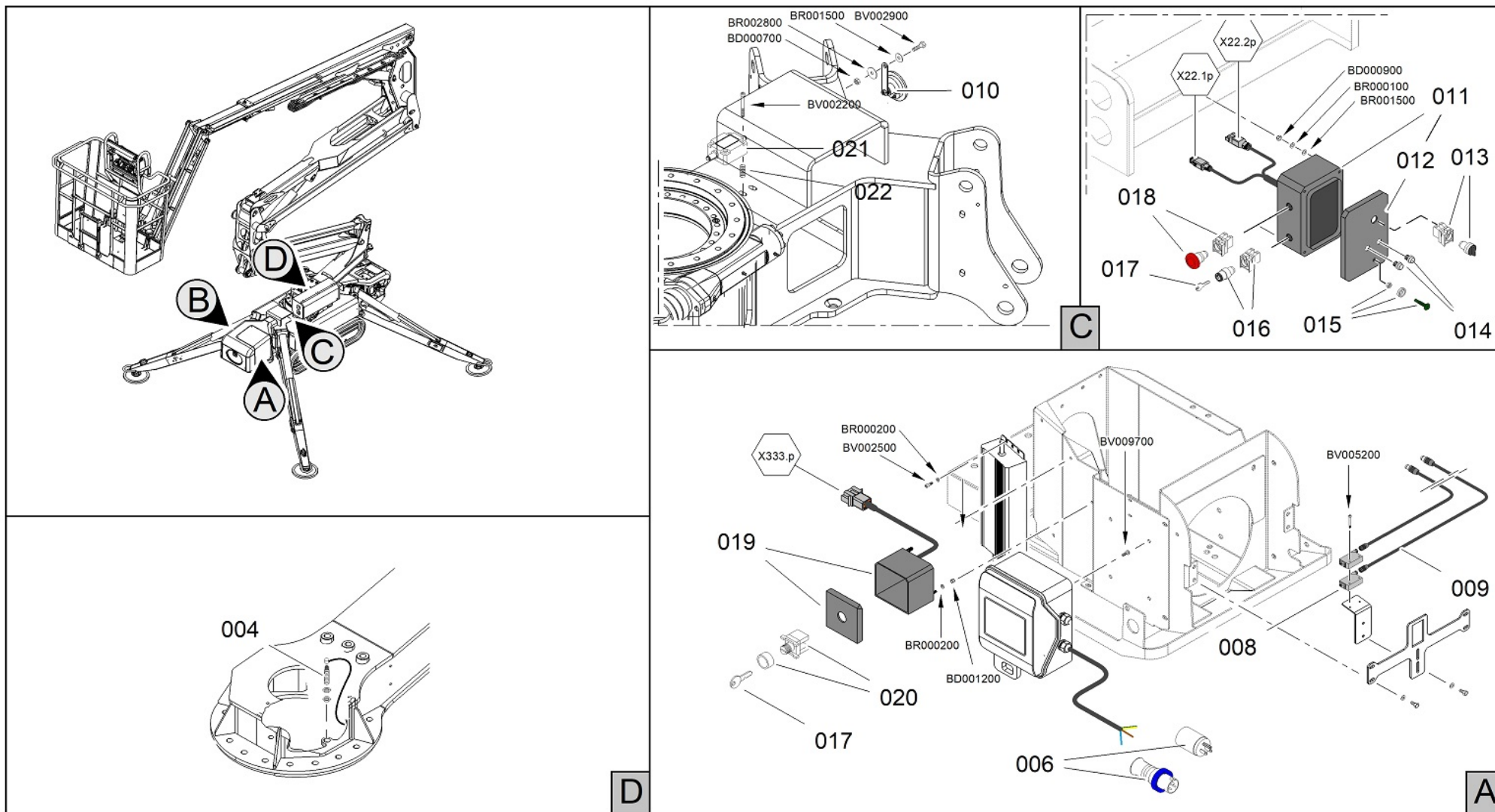
KOMPONENTEN ELEKTROANLAGE 
 COMPONENTES INSTALACIÓN ELÉCTRICA 









Main color codes:  J1 - JLG Cream,  J2 - JLG Orange,  C4 - Green



 COMPONENTI IMPIANTO ELETTRICO

 ELECTRICAL SYSTEM COMPONENTS

 COMPOSANTS INSTALLATION ÉLECTRIQUE

 KOMponenten Elektroanlage 
 Componentes Instalación Eléctrica 

POS	Codice	 Descrizione	 Description	 Designation	 Benennung	 Descripción
4	1651290010	SENSORE DI PROSSIMITÀ	PROXIMITY SENSOR	CAPTEUR DE PROXIMITÉ	NÄHERUNGSSENSOR	SENSOR DE PROXIMIDAD
6	1757250001	SPINA VOLANTE 230V 16A	FREE PLUG 230V 16A	FICHE	STECKER	ENCHUFE
6	1757250002	SPINA VOLANTE 110V 32A	FREE PLUG 110V 32A	CHEVILLE	STIF	CLAVIJA
6	1757250003	SPINA VOLANTE 110V 16A	FREE PLUG 110V 16A	CHEVILLE	STIF	CLAVIJA
6	27074000	TERMINAL PRESA USA A TERRA, CONN PLUG PART N°:4460138	TERMINAL GROUND SOCKET USA, CONN PLUG PART N °: 4460138	CONNECTEUR	VERBINDER	CONECTOR
7	27396100	ANTENNA	AERIAL	ANTENNE	ANTENNE	ANTENA
8	1591270001	FOTOCPELLULA	PHOTOCELL	CELLULE PHOTO-ÉLECTRIQUE	PHOTOZELLE	FOTOCÉLULA
9	159127000101	CAVO ELETTRICO	ELECTRIC CABLE	CÂBLE ÉLECTRIQUE	ELEKTROKABEL	CABLE ELÉCTRICO
10	04834500	CLAXON 12V	HORN	KLAXON	HORN	BOCINA
11	175726002402	SCATOLA STOP A TERRA MK2 E LL2614 VUOTA	STOP BOX MK2 AND LL2614 EMPTY	BOÎTE STOP	KASTEN STOP	CAJA STOP
11	1770750001	SCATOLA STOP A TERRA LITHIUM LL26/X26/X770 LL15/X15/X430 TT COMPLETA DI CABLAGGIO E CONNETTORE	BOX WITH WIRING	BOÎTE AVEC CÂBLAGE	KASTEN MIT VERKABELUNG	CAJA CON CABLEADO
11	1773980003	SCATOLA STOP A TERRA DIESEL LL2614-X26JP-X770AJ TT COMPLETA DI CABLAGGIO E CONNETTORE	BOX WITH WIRING	BOÎTE AVEC CÂBLAGE	KASTEN MIT VERKABELUNG	CAJA CON CABLEADO





 Main color codes:  J1 - JLG Cream,  J2 - JLG Orange,  C4 - Green



 COMPONENTI IMPIANTO ELETTRICO

 ELECTRICAL SYSTEM COMPONENTS

 COMPOSANTS INSTALLATION ÉLECTRIQUE

 KOMponenten Elektroanlage 
 Componentes Instalación Eléctrica 

POS	Codice	 Descrizione	 Description	 Designation	 Benennung	 Descripción
12	175726002401	COPERCHIO SCATOLA STOP A TERRA DIESEL LL2614-X26JP- X770AJ	BOX COVER	COUVERCLE BOÎTE	KASTENABDECKUNG	TAPA DE CAJA
12	175727000201	COPERCHIO SCATOLA STOP A TERRA LITHIUM 83V	BOX COVER	COUVERCLE BOÎTE	KASTENABDECKUNG	TAPA DE CAJA
13	1556350068	SELETTORE A LEVA 3 POSIZIONI	3 POSITION LEVER SWITCH	SÉLECTEUR	WÄHLSCHALTER	SELECTOR
14	1628400005	PULSANTE	BUTTON	BOUTON	DRUCKKNOPF	BOTÓN
15	1730720005	SPIA VERDE PARTE AEREA GRANDE	BIG GREEN LIGHT AERIAL PART	VOYANT	KONTROLLLEUCHTE	INDICADOR
16	1692150001	BLOCCHETTO	BLOCK	BLOC	BLOCK	BLOQUE
17	1651290015	CHIAVE	KEY	CLÉ	SCHLÜSSEL	LLAVE
18	1773980004	PULSANTE	BUTTON	BOUTON	DRUCKKNOPF	BOTÓN
19	1772950019	SCATOLA ESCLUSIONE SICUREZZE COMPLETA TTC	BOX EXCLUSION SAFETY TTC	BOÎTE	GEHÄUSE	CAJA
20	1585570006	SELETTORE	SELECTOR	SÉLECTEUR	WÄHLSCHALTER	SELECTOR
21	17708000	INCLINOMETRO	INCLINOMETER	INCLINOMÈTRE	NEIGUNGSSENSOR	INCLINÓMETRO
22	05444800	MOLLA	SPRING	RESSORT	FEDER	MUELLE

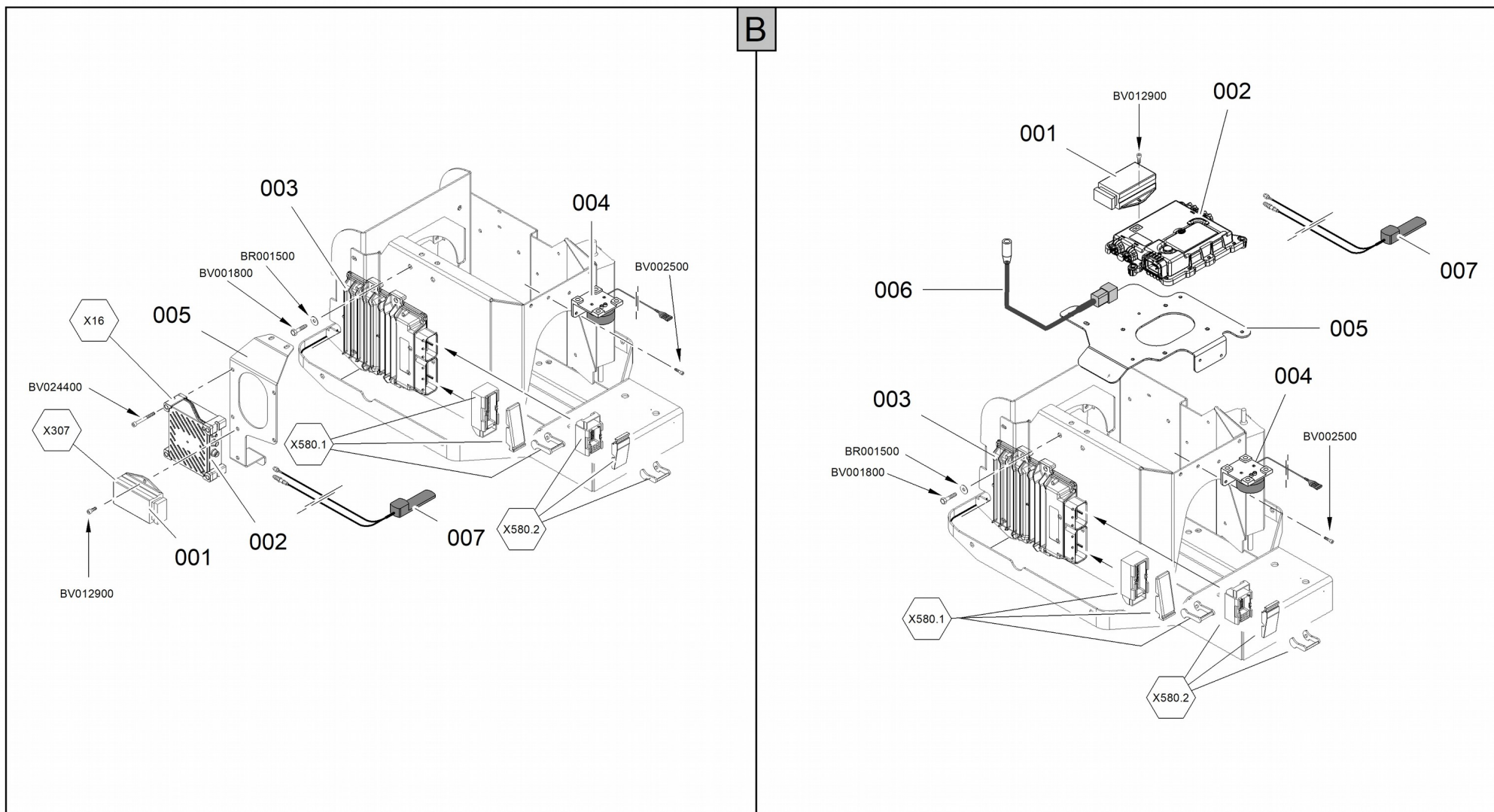

 Main color codes:  J1 - JLG Cream,  J2 - JLG Orange,  C4 - Green









 COMPONENTI IMPIANTO ELETTRICO

 ELECTRICAL SYSTEM COMPONENTS

 COMPOSANTS INSTALLATION ÉLECTRIQUE

 KOMponenten Elektroanlage 
 Componentes Instalación Eléctrica 

POS	Codice	 Descrizione	 Description	 Designation	 Benennung	 Descripción
1	1772950021	CENTRALINA 4 RELE' INDIPENDENTI 12V A TENUTA	CONTROL UNIT 4 RELAY 'INDEPENDENT 12V SEALED	UNITÉ DE CONTRÔLE	STEUERGERÄT	UNIDAD DE CONTROL
2	1772950017	MODEM ESTERNO GPS-4G CAN PROGRAMMATO PER GESTIONE A RICAMBIO	MODEM GPS-4G CAN TO SPARE	MODEM	MODEM	MODEM
2	18448000	SCHEDA MODEM 4G CE-AUSTRALIA	MODEM BOARD 4G CE-AUSTRALIA	CARTE MODEM 4G CE-AUSTRALIA	PLATINE MODEM 4G CE-AUSTRALIA	PLACA MODEM 4G CE-AUSTRALIA
2	1844800001	SCHEDA MODEM 4G CE-AUSTRALIA	MODEM BOARD 4G CE-AUSTRALIA	CARTE MODEM 4G CE-AUSTRALIA	PLATINE MODEM 4G CE-AUSTRALIA	PLACA MODEM 4G CE-AUSTRALIA
2	18448100	SCHEDA MODEM 4G USA	MODEM BOARD 4G USA	CARTE MODEM 4G USA	PLATINE MODEM 4G USA	PLACA MODEM 4G USA
2	1844810001	SCHEDA MODEM 4G USA	MODEM BOARD 4G USA	CARTE MODEM 4G USA	PLATINE MODEM 4G USA	PLACA MODEM 4G USA
3	07844200	RESISTENZA 120 OHM PER CONNETTORE SERIALE RS-232	120 OHM RESISTANCE FOR CONNECTOR RS-232	120 OHM RESISTANCE POUR CONNECTEUR RS-232	120 OHM WIDERSTAND FÜR VERBINDER RS-232	RESISTENCIA 120 OHM PARA CONECTOR RS-232
3	17162400	KIT RAMHINO	RAMHINO KIT	KIT RAMHINO	KIT RAMHINO	KIT RAMHINO
3	17162500	CAVO RAMHINO SCHALTBAU	CAVO RAMHINO SCHALTBAU	CÂBLE	KABEL	CABLE
3	1787280015	SCHEDA MASTER X580 UNIVERSALE VERSIONE SOFTWARE INSTALLATO	MASTER BOARD X580 UNIVERSAL COMPATIBILITIES, SOFTWARE READY	CARTE ÉLECTRONIQUE	ELEKTRONISCHE PLATINE	TARJETA ELECTRÓNICA
3	26582800	ADATTATORE PCAN-USB (IPEH-002021)	ADAPTER	ADAPTEUR	ADAPTER	ADAPTADOR
4	06639100	AVVISATORE ACUSTICO	ACOUSTIC ALARM	BUZZER	SUMMER	ZUMBADOR
5	077739Y1	PIEGATO FISSAGGIO MODEM LL1570	BENT SECURING MODEM LL1570	SUPPORT	HALTERUNG	SOPORTE





 Main color codes:  J1 - JLG Cream,  J2 - JLG Orange,  C4 - Green

 COMPONENTI IMPIANTO ELETTRICO

 ELECTRICAL SYSTEM COMPONENTS

 COMPOSANTS INSTALLATION ÉLECTRIQUE

 KOMponenten Elektroanlage 
 Componentes Instalación Eléctrica 

POS	Codice	 Descrizione	 Description	 Designation	 Benennung	 Descripción
5	082806Y1	STAFFA FISSAGGIO MODEM	MODEM FIXING BRACKET	SUPPORT MODEM	HALTERUNG MODEM	SOPORTE MODEM
6	18359800	PROLUNGA CONNESSIONE MODEM TTC WAVE	TTC WAVE MODEM CONNECTION EXTENSION	RALLONGE	VERLÄNGERUNG	ALARGADERA
7	28448200	ANTENNA 4G/LTE- 2G/3G+GPS/GLO L=150 CONNETTORI FAKRA PER MODEM TTC	AERIAL	LTE + GPS / GLO ANTENNA L = 150 FAKRA CONNECTORS FOR TTC MODEM	ANTENNE	ANTENA

 COMPONENTI IMPIANTO ELETTRICO LITIO



 ELECTRICAL SYSTEM COMPONENTS LITHIUM



 COMPOSANTS INSTALLATION ÉLECTRIQUE LITHIUM

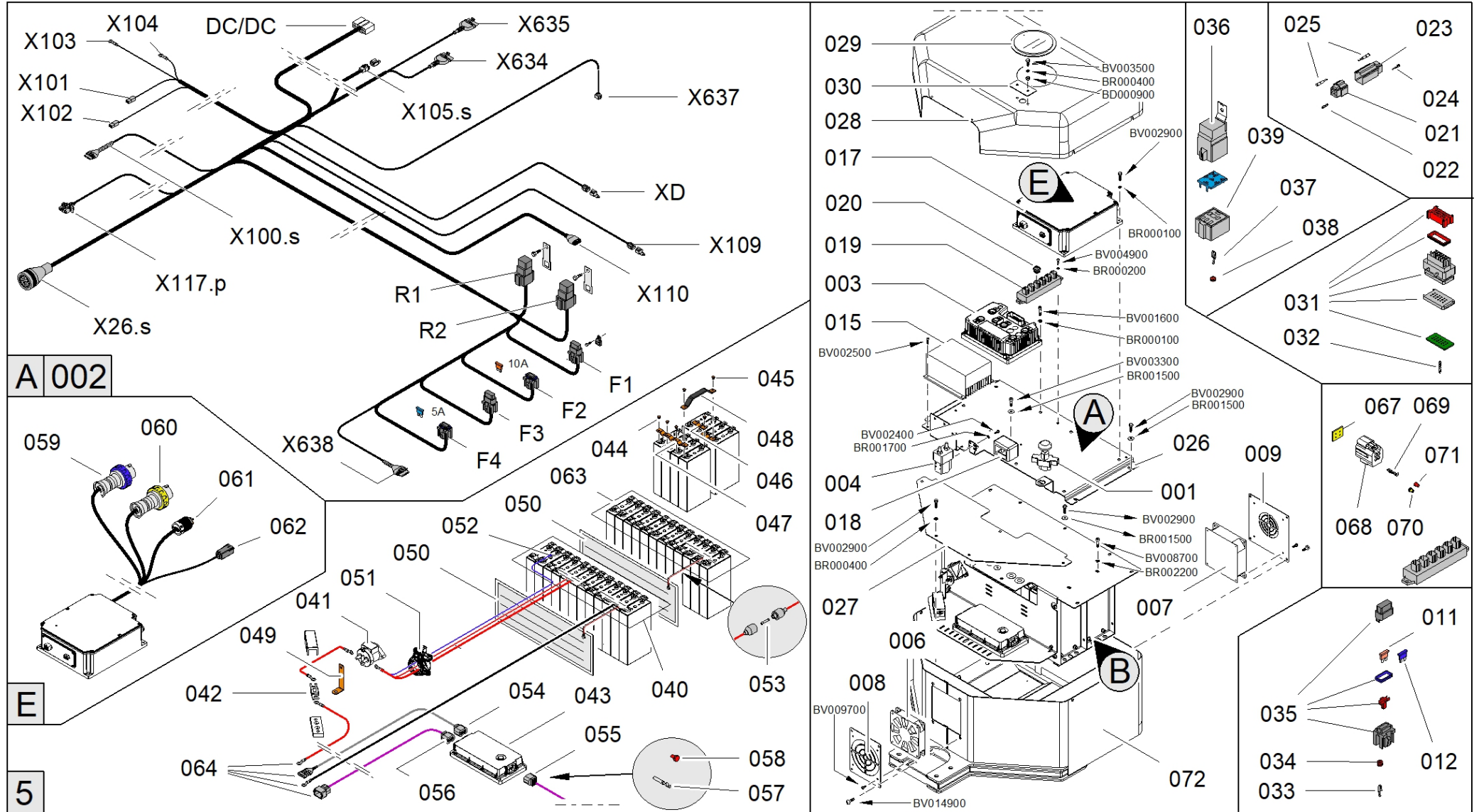

KOMPONENTEN ELEKTROANLAGE LITHIUM 





COMPONENTES INSTALACIÓN ELÉCTRICA LITHIUM 









Main color codes:  J1 - JLG Cream,  J2 - JLG Orange,  C4 - Green



 COMPONENTI IMPIANTO ELETTRICO LITIO
 ELECTRICAL SYSTEM COMPONENTS LITHIUM
 COMPOSANTS INSTALLATION ÉLECTRIQUE LITHIUM





KOMPONENTEN ELEKTROANLAGE LITHIUM 
 COMPONENTES INSTALACIÓN ELÉCTRICA LITHIUM 



POS	Codice	 Descrizione	 Description	 Designation	 Benennung	 Descripción
1	07827000	STACCABATTERIA A FUNGO 150A NOMINALI	BATTERY DISCONNECTERS 150A NOMINAL	COUPE-BATTERIE	BATTERIE-TRENNSCHALTER	DESCONECTADOR DE BATERÍA
2	17757200	KIT ELE INTEGRAZIONE LITHIUM LL1570-X15JP-X430AJ	INTEGRATION KIT ELECTRIC LITHIUM LL1570-X15JP-X430AJ	KIT ÉLECTRIQUE	ELEKTROSATZ	KIT ELÉCTRICO
2	1803220004	MRS RELÈ 12V S3 IMPULSO 2 SEC	MRS RELAY 12V S3 PULSE 2 SEC	MRS RELÉ 12V S3 IMPULSION 2 SEC	MRS RELAIS 12V S3 IMPULS 2 SEK	MRS RELÉ 12V S3 IMPULSO 2 SEC
3	26774600	INVERTER	INVERTER	INVERTER	INVERTER	INVERTER
5	18375100	IMPIANTO ELETTRICO E PACCO BATTERIE LITIO 36V 120AH COMPLETO MID	ELECTRICAL SYSTEM AND BATTERY PACK LITHIUM 36V 120AH COMPLETE MID	INSTALLATION ÉLECTRIQUE	ELEKTRISCHE ANLAGE	INSTALACIÓN ELÉCTRICA
5	27810200	IMPIANTO ELETTRICO E PACCO BATTERIE LITIO 36V 100AH COMPLETO MID	ELECTRICAL SYSTEM AND BATTERY PACK LITHIUM 36V 100AH COMPLETE MID	INSTALLATION ÉLECTRIQUE	ELEKTRISCHE ANLAGE	INSTALACIÓN ELÉCTRICA
6	1690690001	VENTOLA ANTERIORE	FRONT FAN	VENTILATEUR	LÜFTERRAD	VENTILADOR
7	1690690002	VENTOLA POSTERIORE	REAR FAN	VENTILATEUR	LÜFTERRAD	VENTILADOR
8	075692H2	PIASTRA FISSAGGIO VENTOLA	PLATE	PLAQUE	PLATTE	PLACA
9	067808H2	TAPPO VENTOLA POSTERIORE	CAP REAR FAN	BOUCHON	VERSCHLUSS	TAPÓN
11	05760700	FUSIBILE A LAMA 5A	FUSE 5A	FUSIBLE 5A	SICHERUNG 5A	FUSIBLE 5A
12	05760900	FUSIBILE 10A	FUSE 10A	FUSIBLE 10A	SICHERUNG 10A	FUSIBLE 10A
15	27032500	DC-DC IN36-72V OUT 12V16A VERSIONE LITHIUM CON TRATTAMENTO TRP	DC-DC IN36-72V OUT 12V16A LITHIUM VERSION WITH TRP TREATMENT	TRANSFORMATEUR	TRANSFORMATOR	TRANSFORMADOR

Main color codes:  J1 - JLG Cream,  J2 - JLG Orange,  C4 - Green

 COMPONENTI IMPIANTO ELETTRICO LITIO
 ELECTRICAL SYSTEM COMPONENTS LITHIUM
 COMPOSANTS INSTALLATION ÉLECTRIQUE LITHIUM



KOMPONENTEN ELEKTROANLAGE LITHIUM 
 COMPONENTES INSTALACIÓN ELÉCTRICA LITHIUM 



POS	Codice	 Descrizione	 Description	 Designation	 Benennung	 Descripción
17	17193200	CARICABATTERIE LITIO 48V-230V COMPLETO DI CABLAGGIO	LITHIUM BATTERY CHARGER 48V-230V COMPLETE WITH WIRING	CHARGEUR DE BATTERIE	LADEGERÄT	CARGADOR DE BATERÍA
17	17193300	CARICABATTERIE LITIO 48V-110/120V COMPLETO DI CABLAGGIO	LITHIUM BATTERY CHARGER 48V- 110/120V COMPLETE WITH WIRING	CHARGEUR DE BATTERIE	LADEGERÄT	CARGADOR DE BATERÍA
18	1730720088	ISOLATORE CONNESSIONE MASSA	INSULATOR EARTH CONNECTION	ISOLATEUR	ISOLATOR	AISLADOR
19	1730720087	CONNETTORE DERIVAZIONE CAN	JUNCTION CONNECTOR CAN	CONNECTEUR	VERBINDER	CONECTOR
20	1730720086	TAPPO CONNETTORE 2 VIE	CONNECTOR PLUG 2 WAY	BOUCHON CONNECTEUR	VERSCHLUSS VERBINDER	TAPA CONECTOR
20	1730720098	TAPPO PER CONNETTORE DERIVAZIONE CAN	CAP JUNCTION CONNECTOR CAN	CAP CONNECTEUR	CAP VERBINDER	CAP CONECTOR
21	1757250009	CONNETTORE PORTA FEMMINE 4 VIE MOLEX 220-110V 20- 25A	CONNECTOR	CONNECTEUR	VERBINDER	CONECTOR
22	1757250011	PUNTALINO	FERRULE	EMBOUT	ZWINGE	PUNTERA
23	1757250010	CONNETTORE PORTA MASCHI 4 VIE MOLEX 220-110V 20-25A	CONNECTOR	CONNECTEUR	VERBINDER	CONECTOR
24	1757250013	PUNTALINO MASCHIO PER CONNETTORE 4 VIE MOLEX 220-110V 20-25A	FERRULE	EMBOUT	ZWINGE	PUNTERA



 COMPONENTI IMPIANTO ELETTRICO LITIO
 ELECTRICAL SYSTEM COMPONENTS LITHIUM
 COMPOSANTS INSTALLATION ÉLECTRIQUE LITHIUM

KOMPONENTEN ELEKTROANLAGE LITHIUM 
 COMPONENTES INSTALACIÓN ELÉCTRICA LITHIUM 



POS	Codice	 Descrizione	 Description	 Designation	 Benennung	 Descripción
25	1757250012	TAPPO PER CHIUSURA FORI SU CONNETTORE 4 VIE MOLEX 220-110V 20-25A	CAP	BOUCHON	DECKEL	TAPA
26	178034D1	PIEGATO FISSAGGIO COMPONENTI PACCO LITIO LL1570-X15JP-X430AJ	COMPONENTS FIXING PACK LITHIUM LL1570-X15JP-X430AJ	SUPPORT	HALTERUNG	SOPORTE
27	178027D1	CARTER SUPERIORE CASSONE PACCO LITIO LL1570-X15JP-X430AJ	CARTER TOP LITHIUM LL1570-X15JP-X430AJ	CARTER	KUBELGEHÄUSE	CÁRTER
28	178035D1	COFANO SUPERIORE	COVER UPPER	COFFRE	MOTORHAUBE	CAPO
29	07377300	PROTEZIONE TRASPARENTE LED CARICABATTERIE PACCO LITIO 72V	TRANSPARENT PROTECTION CHARGER LED	PROTECTION TRANSPARENT	TRANSPARENT SCHUTZART	PROTECCIÓN TRANSPARENTE
30	178574D1	CHIUSURA FORI FISSAGGIO PER LAMPEGGIANTE SU PACCO LITIO	CLOSING FIXING HOLES FOR FLASHING ON PACK LITHIUM	FERMETURE	SCHLUSS	CIERRE
31	16774700	CONNETTORE AMP. AMPSEAL FE.35 VIE INVERTER 36-48 V	CONNECTOR AMP. AMPSEAL FE.35 VIE INVERTER 36-48 V	CONNECTEUR	VERBINDER	CONECTADOR
32	16774800	PUNTALINO FE05-1 MMQ AMPSEAL STAGNATO GL14.70 BATTERY	TERMINAL	BORNE	KLEMME	BORNE
33	1757260006	PUNTALINO PER PORTAFUSIBILE	FERRULE FOR FUSE HOLDER	BORNE	KLEMME	BORNE
34	1757260007	GOMMINO PER PORTAFUSIBILE	RUBBER FERRULE FOR FUSE HOLDER	INSERT CAOUTCHOUC	GUMMISATZ	INSERCIÓN DE GOMA
35	1757260001	PORTAFUSIBILE	FUSE HOLDER	PORTE-FUSIBLE	SICHERUNGSHALTER	PORTAFUSIBILE



Main color codes:  J1 - JLG Cream,  J2 - JLG Orange,  C4 - Green



 COMPONENTI IMPIANTO ELETTRICO LITIO
 ELECTRICAL SYSTEM COMPONENTS LITHIUM
 COMPOSANTS INSTALLATION ÉLECTRIQUE LITHIUM





KOMPONENTEN ELEKTROANLAGE LITHIUM 
 COMPONENTES INSTALACIÓN ELÉCTRICA LITHIUM 



POS	Codice	 Descrizione	 Description	 Designation	 Benennung	 Descripción
36	1776330003	RELE' MINI TYCO 12V PER CONNETTORE A TENUTA (MK2 DA C170000893)	RELAY 'MINI 12V TYCO CONNECTOR SEAL (MK2 FROM C170000893)	RELAIS	RELAIS	RELÉ
37	1776330007	PUNTALINI PER RELE' A TENUTA MINI TYCO 12V (MK2 DA C170000893)	FERRULE FOR RELAY SEAL MINI 12V TYCO (MK2 FROM C170000893)	BORNE	KLEMME	BORNE
38	1776330005	GOMMINO PER RELE' A TENUTA MINI TYCO 12V (MK2 DA C170000893)	RUBBER FOR RELAY SEAL MINI 12V TYCO (MK2 FROM C170000893)	JOINT RELÉ	GUMMIDICHTUNG	JUNTA DE GOMA
39	1776330004	PORTA RELE' A TENUTA PER MINI TYCO 12V (MK2 DA C170000893)	HOLDER RELAY SEAL FOR MINI 12V TYCO (MK2 FROM C170000893)	PORTE RELAIS	RELAISHALTER	PORTARELÉ
40	1779520002	MODULO CELLE LITIO MIDAC 19,2V 100AH CONFIG. "A" COMPLETO DI CONNESSIONE A CORREDO	MIDAC LITHIUM CELL MODULE 19,2V 100AH CONFIG. "A" COMPLETE WITH CONNECTION SUPPLIED	MODULE BATTERIE LITHIUM-ION	MODUL LITHIUM-IONEN-BATTERIE	MÓDULO BATERÍA LITIO
40	1837510002	MODULO CELLE LITIO MIDAC 19,2V 100AH CONFIG. "A" COMPLETO DI CONNESSIONE A CORREDO	MIDAC LITHIUM CELL MODULE 19,2V 100AH CONFIG. "A" COMPLETE WITH CONNECTION SUPPLIED	MODULE CELLULE LITHIUM MIDAC	LITHIUM-ZELLENMODUL MIDAC	MÓDULO CÉLULAS LITIO MIDAC
41	2781020012	TELERUTTORE DI POTENZA 500A	RELAY OF INTERNAL POWER PACK 500A	TELERUPTEUR 500A	FERNSCHALTER 500A	TELEINTERRUPTOR 500A
42	2781020014	FUSIBILE 400A	FUSE 400A	FUSIBLE	SICHERUNG	FUSIBLE
43	1837510001	BMS MASTER MID PROGRAMMATO PER 36V 100AH	BMS MASTER MID FOR 36V 100AH	BMS MASTER MID 36V 100AH	BMS MASTER MID 36V 100AH	BMS MASTER MID 36V 100AH



Main color codes:  J1 - JLG Cream,  J2 - JLG Orange,  C4 - Green

 COMPONENTI IMPIANTO ELETTRICO LITIO
 ELECTRICAL SYSTEM COMPONENTS LITHIUM
 COMPOSANTS INSTALLATION ÉLECTRIQUE LITHIUM





KOMPONENTEN ELEKTROANLAGE LITHIUM 
 COMPONENTES INSTALACIÓN ELÉCTRICA LITHIUM 



POS	Codice	 Descrizione	 Description	 Designation	 Benennung	 Descripción
43	2781020017	BMS MASTER MID PROGRAMMATO PER 36V 100AH	BMS MASTER MID FOR 36V 100AH	BMS MASTER MID 36V 100AH	BMS MASTER MID 36V 100AH	BMS MASTER MID 36V 100AH
44	2781020003	RIVETTO RAME H=10	COPPER RIVET H=10	RIVET	NIETE	REMACHE
45	2781020004	RIVETTO RAME H=12	COPPER RIVET H=12	RIVET	NIETE	REMACHE
46	2781020005	LAMA FISSAGGIO CELLE 2 FORI	PLATE FIXING CELLS 2 HOLES	PLAQUE DE FIXATION	MONTAGEPLATTE	PLACA DE FIJACION
47	2781020006	LAMA FISSAGGIO CELLE 4 FORI	PLATE FIXING CELLS 4 HOLES	PLAQUE DE FIXATION	MONTAGEPLATTE	PLACA DE FIJACION
48	2781020007	LAMA DI COLLEGAMENTO TRA MODULI	PLATE CONNECTION BETWEEN MODULES	PLAQUE DE CONEXION	VERBINDUNGSPLATTE	PLACA DE CONEXIÓN
49	2781020008	LAMA COLLEGAMENTO TELERUTTORE	PLATE CONNECTION RELAY	PLACA DE CONEXIÓN	VERBINDUNGSPLATTE	PLACA DE CONEXIÓN
50	2781020009	HEATER 36V 60W	HEATER 36V 60W	CHAUFFAGE 36V 60W	HEIZUNG 36V 60W	CALENTADOR 36V 60W
51	2781020011	SENSORE LEM PER LITIO MID	LEM SENSOR FOR LITHIUM MID	CAPTEUR	SENSOR	SENSOR
52	2781020013	SENSORE TEMPERATURA PACCO LITIO MID	TEMPERATURE SENSOR PACK LITHIUM MID	CAPTEUR	SENSOR	SENSOR
53	2781020015	FUSIBILE	FUSE	FUSIBLE	SICHERUNG	FUSIBLE
54	2781020019	CONNETTORE BMS 34 VIE FASATURA 1	CONNECTOR BMS 34 WAYS STEP 1	CONNECTEUR	VERBINDER	CONECTOR
55	2781020020	CONNETTORE BMS 34 VIE FASATURA 2	CONNECTOR BMS 34 WAYS STEP 2	CONNECTEUR	VERBINDER	CONECTOR
56	2781020021	CONNETTORE BMS 26 VIE	CONNECTOR BMS 26 WAYS	CONNECTEUR	VERBINDER	CONECTOR
57	2781020022	PIN PER CONNETTORI BMS 0,75-1,25	PIN CONNECTORS FOR BMS 0.75-1.25	BROCHE POUR CONNECTEURS	PIN-ANSCHLÜSSE	PIN PARA CONECTORES
58	2781020023	TAPPO PER CONNETTORI BMS	CAP FOR CONNECTORS BMS	COUVERCLE	DECKEL	TAPA



Main color codes:  J1 - JLG Cream,  J2 - JLG Orange,  C4 - Green

 COMPONENTI IMPIANTO ELETTRICO LITIO
 ELECTRICAL SYSTEM COMPONENTS LITHIUM
 COMPOSANTS INSTALLATION ÉLECTRIQUE LITHIUM





KOMPONENTEN ELEKTROANLAGE LITHIUM 
 COMPONENTES INSTALACIÓN ELÉCTRICA LITHIUM 

POS	Codice	 Descrizione	 Description	 Designation	 Benennung	 Descripción
59	1757250001	SPINA VOLANTE 230V 16A	FREE PLUG 230V 16A	FICHE	STECKER	ENCHUFE
60	1757250003	SPINA VOLANTE 110V 16A	FREE PLUG 110V 16A	CHEVILLE	STIF	CLAVIJA
61	27074000	TERMINAL PRESA USA A TERRA, CONN PLUG PART N°:4460138	TERMINAL GROUND SOCKET USA, CONN PLUG PART N °: 4460138	CONNECTEUR	VERBINDER	CONECTOR
62	1757250010	CONNETTORE PORTA MASCHI 4 VIE MOLEX 220-110V 20-25A	CONNECTOR	CONNECTEUR	VERBINDER	CONECTOR
62	1757250012	TAPPO PER CHIUSURA FORI SU CONNETTORE 4 VIE MOLEX 220-110V 20-25A	CAP	BOUCHON	DECKEL	TAPA
62	1757250013	PUNTALINO MASCHIO PER CONNETTORE 4 VIE MOLEX 220-110V 20-25A	FERRULE	EMBOUT	ZWINGE	PUNTERA
63	1779520003	MODULO CELLE LITIO MIDAC 19,2V 100AH CONFIG. "B" COMPLETO DI CONNESSIONE A CORREDO	MIDAC LITHIUM CELL MODULE 19,2V 100AH CONFIG. "B" COMPLETE WITH CONNECTION SUPPLIED	MODULE BATTERIE LITHIUM-ION	MODUL LITHIUM-IONEN-BATTERIE	MÓDULO BATERÍA LITIO
63	1837510003	MODULO CELLE LITIO MIDAC 19,2V 100AH CONFIG. "B" COMPLETO DI CONNESSIONE A CORREDO	MIDAC LITHIUM CELL MODULE 19,2V 100AH CONFIG. "B" COMPLETE WITH CONNECTION SUPPLIED	MODULE CELLULE LITHIUM MIDAC	LITHIUM-ZELLENMODUL MIDAC	MÓDULO CÉLULAS LITIO MIDAC



Main color codes:  J1 - JLG Cream,  J2 - JLG Orange,  C4 - Green

 COMPONENTI IMPIANTO ELETTRICO LITIO
 ELECTRICAL SYSTEM COMPONENTS LITHIUM
 COMPOSANTS INSTALLATION ÉLECTRIQUE LITHIUM



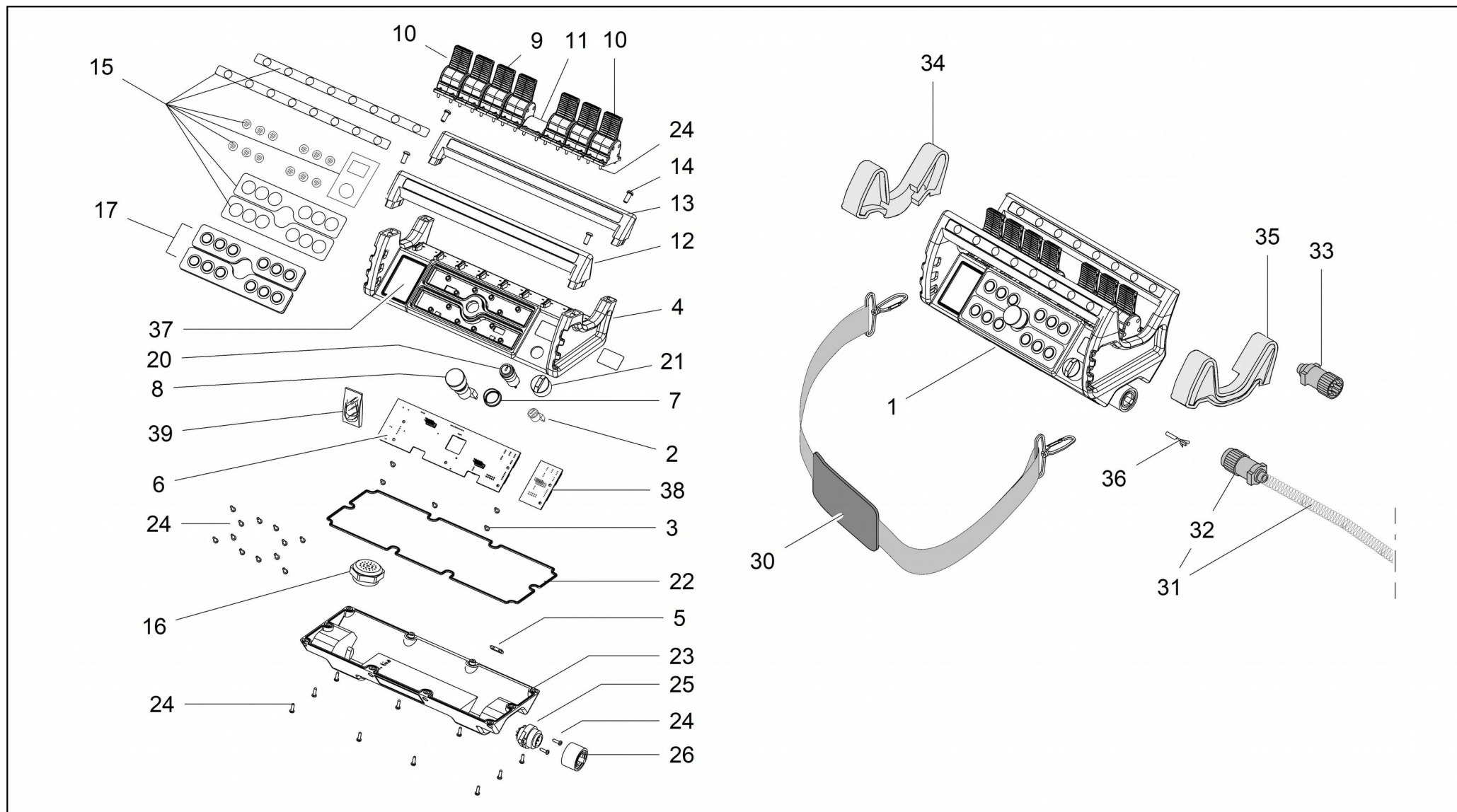

KOMPONENTEN ELEKTROANLAGE LITHIUM 
 COMPONENTES INSTALACIÓN ELÉCTRICA LITHIUM 



POS	Codice	 Descrizione	 Description	 Designation	 Benennung	 Descripció
64	2781020024	CABLAGGIO PER CONNESSIONI PACCO LITIO 36V 100AH (SPG0406)	WIRING FOR LITHIUM CONNECTIONS 36V 100AH (SPG0406)	CÂBLES	VERKABELUNG	CABLES
65	26429300	TELERUTTORE	POWER SWITCH RELAY	TÉLÉRUPTEUR	FERNSCHALTER	TELERUPTOR
67	1823960002	COVER CONNETTORE 4 VIE	COVER CONNECTOR	COVER CONNECTEUR	COVER VERBINDER	COVER CONECTADOR
68	1823960001	CONNETTORE 4 VIE	CONNECTOR	CONNECTEUR	VERBINDER	CONECTADOR
69	1739150027	PUNTALINO PER CONNETTORE PULSANTE CAVO 0,5-1	BUTTON CABLE CONNECTOR FERRULE 0.5-1	EMBOUT POUR BORNE BOUTON CÂBLE 0,5-1	VERSCHRAUBUNG	PUNTA PARA CONECTOR BOTÓN CABLE 0,5-1
70	1823960004	COVER CONNETTORE 4 VIE	RUBBER	CAOUTCHOUC POUR CONNECTEUR	GUMMISTÜCK FÜR STECKVERBINDER	GOMA PARA CONECTOR
71	1823960003	GOMMINO CHIUSO	CLOSED RUBBER	CAOUTCHOUC POUR CONNECTEUR	GUMMISTÜCK FÜR STECKVERBINDER	GOMA PARA CONECTOR
72	178036D1					







 TELECOMANDO
 REMOTE CONTROL
 TÉLÉCOMMANDE

FERNSTEUERUNG 
 TELECOMANDO 



POS	Codice	 Descrizione	 Description	 Designation	 Benennung	 Descripción
1	27237400	TELECOMANDO CASE GRIGIO	REMOTE CONTROL GREY CASE	TÉLÉCOMMANDE	FERNSTEUERUNG	TELECOMANDO
2	07359400	CONTATTO PER STOP EMERGENZA TELECOMANDO 3S	CONTACT FOR EMERGENCY STOP REMOTE CONTROL 3S	CONTACTE POUR ARRET D'URGENCE	KONTAKT FÜR NOTSTOP	CONTACTO PARA PARADA DE EMERGENCIA
3	2646170003	VITI SCHEDA ELETTRONICA	ELECTRONIC BOARD SCREWS	VIS	SCHRAUBEN	TORNILLOS
4	2723740001	COPERCHIO SUPERIORE TELECOMANDO CASE GRIGIO + DISPLAY E PULSANTI (PER RICAMBIO È NECESSARIO IL SN DEL TELECOMANDO)	TOP COVER REMOTE CONTROL CASE GREY + DISPLAY AND BUTTONS (AS SPARE IS COMPULSORY THE SN OF REMOTE CONTROL)	COUVERCLE	DECKEL	TAPA
4	2723740002	COPERCHIO SUPERIORE TELECOMANDO CASE GRIGIO SOLO COPERCHIO, SENZA COMPONENTI E SENZA DISPLAY	TOP COVER REMOTE CONTROL CASE GREY ONLY CASE, WITHOUT COMPONENTS AND DISPLAY	COUVERCLE	DECKEL	TAPA
5	07359500	CONTATTO REED INTERNO TELECOMANDO 3S	REED CONTACT INTERNAL REMOTE 3S	REED CONTACT INTÉRIEUR 3S DISTANCE	REEDKONTAKT INDOOR REMOTE 3S	CONTACTO REED 3S REMOTO DE INTERIOR
6	2646170002	SCHEDA ELETTRONICA PER TELECOMANDO	ELECTRONIC BOARD FOR REMOTE CONTROL	FICHE ÉLECTRIQUE	ELEKTRONISCHE PLATINE	PLACA ELECTRÓNICA
7	2646170007	ANELLO	RING	BAGUE	RING	ANILLO
8	2646170008	PULSANTE EMERGENZA	EMERGENCY BUTTON	BOUTON D'URGENCE	NOTSTOP KNOPF	PULSADOR DE EMERGENCIA
9	17550700	KIT PROTEZIONE IN GOMMA PER JOYSTICK NERA	PROTECTION KIT	PROTECTION KIT	GUMMISCHUTZ KIT	PROTECCIÓN DE GOMA



Main color codes:  J1 - JLG Cream,  J2 - JLG Orange,  C4 - Green

 TELECOMANDO
 REMOTE CONTROL
 TÉLÉCOMMANDE





FERNSTEUERUNG 
 TELECOMANDO 

POS	Codice	 Descrizione	 Description	 Designation	 Benennung	 Descripción
9	2646170009	LEVA NERA	LEVER BLACK	LEVIER	HEBEL	PALANCA
10	17550800	KIT PROTEZIONE IN GOMMA PER JOYSTICK ROSSA	PROTECTION	PROTECTION	GUMMISCHUTZ	PROTECCION DE GOMA
10	2646170010	LEVA ROSSA	LEVER RED	LEVIER	HEBEL	PALANCA
12	2646170012	IMPUGNATURA SUPERIORE	GRIP UPPER PART	POIGNÉE	GRIFF	EMPUÑADURA
13	2646170013	IMPUGNATURA INFERIORE	GRIP LOWER PART	POIGNÉE	GRIFF	EMPUÑADURA
14	2646170014	VITE	SCREW	VIS	SCHRAUBE	TORNILLO
15	27005200	KIT ADESIVI	DECALS KIT	KIT AUTOCOLLANTS	AUFKLEBERSATZ	KIT PEGATINAS
16	2646170027	CICALINO COMPLETO DI SCHEDA ELETTRONICA TELECOMANDO	BEEPER FOR REMOTE CONTROL	BUZZER	SUMMER	ZUMBADOR COMPLETO DE TARJETA ELECTRÓNICA TELEMANDO
17	2646170017	PULSANTI	BUTTONS	BOUTONS	DRUCKKNÖPFE	BOTONES
20	2683930001	INTERRUTTORE	SWITCH	INTERRUPTEUR	SCHALTER	INTERRUPTOR
21	2683930002	CHIAVE ACCENSIONE	IGNITION KEY	CLÉ DE DÉMARRAGE	ZÜNDSCHLÜSSEL	LLAVE DE ENCENDIDO
22	2646170022	GUARNIZIONE	GASKET	JOINT	DICHTUNG	GUARNICIÓN
23	2646170023	COPERCHIO INFERIORE	COVER LOWER PART	COUVERCLE	DECKEL	TAPA
24	2646170024	VITE	SCREW	VIS	SCHRAUBE	TORNILLO
25	2646170025	CONNETTORE	CONNECTOR	CONNECTEUR	VERBINGER	CONECTOR
26	2646170026	COPERCHIO CONNETTORE	COVER CONNECTOR	COUVERCLE	DECKEL	TAPA
30	2646170030	CINGHIA	BELT	COURROIE	RIEMEN	CORREA
31	17235800	CAVO TELECOMANDO COMPLETO IIIS /200	COMPLETE REMOTE CONTROL CABLE IIIS / 200	CÂBLE COMPLET TÉLÉCOMMANDE IIIS /200	FERNBEDIENUNGSKABEL KOMPLETT IIIS / 200	CABLE TELECOMANDO COMPLETO IIIS /200
32	2646170032	CONNETTORE COLLEGAMENTO TELECOMANDO	CONNECTOR FOR REMOTE CONTROL	CONNECTEUR	VERBINGER	CONECTOR



Main color codes:  J1 - JLG Cream,  J2 - JLG Orange,  C4 - Green



 TELECOMANDO
 REMOTE CONTROL
 TÉLÉCOMMANDE

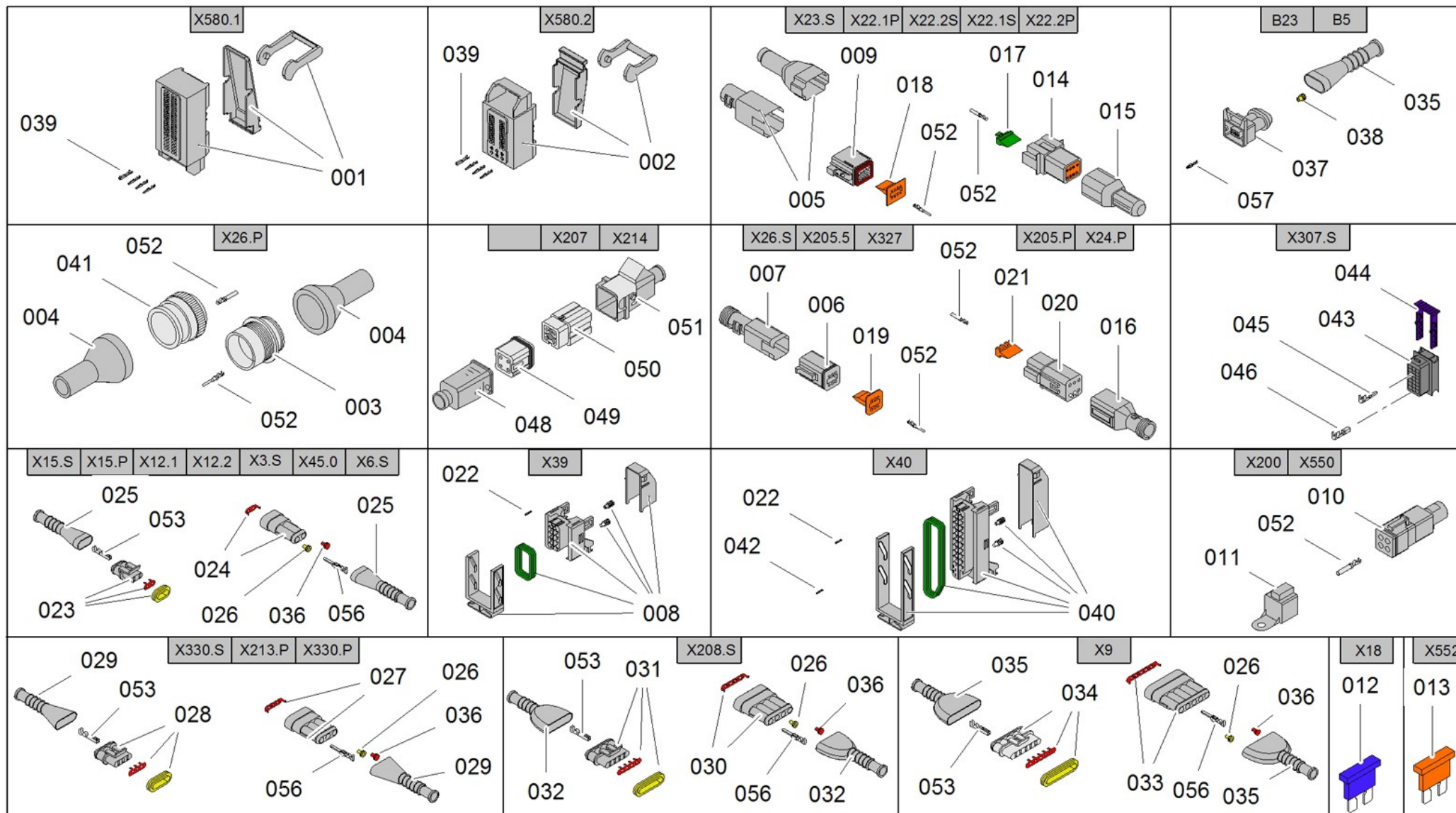



FERNSTEUERUNG 
 TELECOMANDO 



POS	Codice	 Descrizione	 Description	 Designation	 Benennung	 Descripción
33	08027200	DISPOSITIVO DI COMANDO PER ABILITAZIONE EMERGENZA A TERRA	CONTROL DEVICE FOR ACTIVATING THE EMERGENCY GROUND	DISPOSITIF DE COMMANDE EN CAS D'URGENCE	STEUERVORRICHTUNG IM NOTFALL	DISPOSITIVO DE CONTROL DE EMERGENCIA
33	1684540001	DISPOSITIVO DI COMANDO PER ABILITAZIONE EMERGENZA A TERRA	CONTROL DEVICE FOR ACTIVATING THE EMERGENCY GROUND	DISPOSITIF DE COMMANDE EN CAS D'URGENCE	STEUERVORRICHTUNG IM NOTFALL	DISPOSITIVO DE CONTROL DE EMERGENCIA
34	07027100	PROTEZIONE SINISTRA	LEFT PROTECTION	PROTECTION GAUCHE	ABDECKUNG LINKS	PROTECCIÓN IZQUIERDA
35	07027200	PROTEZIONE DESTRA	RIGHT PROTECTION	PROTECTION DROITE	ABDECKUNG RECHTS	PROTECCIÓN DERECHA
36	27283000	PUNTALINO FEMMINA PER CONNETTORE TELECOMANDO	TERMINAL FEMALE CONNECTOR FOR REMOTE CONTROL	CONNECTEUR FEMELLE	VERBINDUNG	CONECTOR
36	2728300001	PUNTALINO MASCHIO PER CONNETTORE TELECOMANDO	TERMINAL MALE CONNECTOR FOR REMOTE CONTROL	CONNECTEUR	VERBINDER	CONECTOR
37	07320200	SCHERMO LCD (PER RICAMBIO È NECESSARIO IL SN DEL TELECOMANDO)	DISPLAY (AS SPARE IS COMPULSORY THE SN OF REMOTE CONTROL)	ÉCRAN	DISPLAY	PANTALLA
38	2646170006	SCHEDA DI TENSIONE TELECOMANDO	POWER BOARD FOR REMOTE CONTROL	CARTE	PLATINE	PLACA
39	2646170036	KIT CABLAGGIO INTERNO TELECOMANDO	INTERNAL CABLE KIT FOR REMOTE CONTROL	KIT CÂBLES TELECOMMANDE	SATZ KABEL FERNBEDIENUNG	KIT CABLES TELEMANDO







 IMPIANTO ELETTRICO
 ELECTRICAL SYSTEM
 INSTALLATION ÉLECTRIQUE



ELEKTRISCHE ANLAGE 
 INSTALACIÓN ELÉCTRICA 



POS	Codice	 Descrizione	 Description	 Designation	 Benennung	 Descripción
1	1757250027	CAPPUCCIO POSTERIORE PER CONNETTORE 6 VIE FEMMINA	CAP	CAPUCHON	KAPPE	TAPA
1	1772950005	CONNETTORE X580.1	CONNECTOR X580.1	CONNECTEUR	VERBINDER	CONECTADOR
2	1772950006	CONNETTORE X580.2	CONNECTOR X580.2	CONNECTEUR	VERBINDER	CONECTADOR
3	1730720051	CONNETTORE 29 VIE M MOTORE (X26)	CONNECTOR	CONNECTEUR	VERBINDER	CONECTOR
4	1730720054	CAPPUCCIO POSTERIORE	CAP	CAPUCHON	KAPPE	CAPUCHO
5	1730720035	COVER POSTERIORE RIGIDA PER CONNETTORE 8 VIE MASCHIO	PROTECTION	PROTECTION	SCHUTZ	PROTECCION
5	1757250025	CAPPUCCIO POSTERIORE PER CONNETTORE MASCHIO	CAP	CAPUCHON	KAPPE	TAPA
6	1730720037	CONNETTORE 6 VIE MASCHIO	6-WAY MALE CONNECTOR	CONNECTEUR 6 VOIES MÂLE	6-WEGE-VERBINDER	CONECTOR 6 VÍAS
7	1730720039	COVER POSTERIORE RIGIDA PER CONNETTORE 6 VIE MASCHIO	PROTECTION	PROTECTION	SCHUTZ	PROTECCION
8	1772950009	CONNETTORE PER 48XS 28 POLI	CONNECTOR FOR 48XS 28P	CONNECTEUR	KLEMME	BORNE
9	1730720033	CONNETTORE 8 VIE MASCHIO	8-WAY MALE CONNECTOR	CONNECTEUR 8 VOIES MÂLE	8-WEGE-VERBINDER STIFT	CONECTOR 8 VÍAS MACHO
10	1763330001	CONNETTORE 4 VIE MASCHIO DEUTSCH	4-WAY MALE CONNECTOR DEUTSCH	CONNECTEUR 4 VOIES MÂLE DEUTSCH	4-WEGE-VERBINDER STIFT DEUTSCH	CONECTOR 4 VÍAS MACHO DEUTSCH
10	4460897	CONNECTOR, DEUTSCH DT 2PIN FEMALE	CONNECTOR, DEUTSCH DT 2PIN FEMALE	CONNECTOR, DEUTSCH DT 2PIN FEMALE	CONNECTOR, DEUTSCH DT 2PIN FEMALE	CONNECTOR, DEUTSCH DT 2PIN FEMALE



Main color codes:  J1 - JLG Cream,  J2 - JLG Orange,  C4 - Green



 IMPIANTO ELETTRICO
 ELECTRICAL SYSTEM
 INSTALLATION ÉLECTRIQUE





ELEKTRISCHE ANLAGE 
 INSTALACIÓN ELÉCTRICA 



POS	Codice	 Descrizione	 Description	 Designation	 Benennung	 Descripción
11	1763330002	CAPPUCCIO FRONTALE CONNETTORE 4 VIE MASCHIO DEUTSCH	CAP FOR 4-WAY MALE CONNECTOR DEUTSCH	PAC CONNECTEUR 4 VOIES MÂLE DEUTSCH	CAP 4-WEGE-VERBINDER STIFT DEUTSCH	CAP CONECTOR 4 VÍAS MACHO DEUTSCH
12	07700700	FUSIBILE A LAMA 25A	FUSE 25A	FUSIBLE 25A	SICHERUNG 25A	FUSIBLE 25A
13	05760700	FUSIBILE A LAMA 5A	FUSE 5A	FUSIBLE 5A	SICHERUNG 5A	FUSIBLE 5A
14	1730720029	CONNETTORE 8 VIE FEMMINA	8-WAY FEMALE CONNECTOR	CONNECTEUR 8 VOIES FEMELLE	8-WEGE-VERBINDER BUCHSE	CONECTOR 8 VÍAS HEMBRA
15	1730720031	COVER POSTERIORE RIGIDA PER CONNETTORE 8 VIE FEMMINA	PROTECTION	PROTECTION	SCHUTZ	PROTECCION
15	1757250026	CAPPUCCIO POSTERIORE PER CONNETTORE FEMMINA	CAP	CAPUCHON	KAPPE	TAPA
16	1730720084	COVER POSTERIORE RIGIDA PER CONNETTORE 6 VIE FEMMINA	PROTECTION	PROTECTION	SCHUTZ	PROTECCION
17	1730720030	PIASTRINA DI BLOCCAGGIO CONNETTORE 8 VIE FEMMINA	PLATE	PLAQUE	PLATTE	PLACA
18	1730720034	PIASTRINA DI BLOCCAGGIO CONNETTORE 8 VIE MASCHIO	PLATE	PLAQUE	PLATTE	PLACA
19	1730720038	PIASTRINA DI BLOCCAGGIO CONNETTORE 6 VIE MASCHIO	PLATE	PLAQUE	PLATTE	PLACA
20	1730720041	CONNETTORE 6 VIE FEMMINA	6-WAY FEMALE CONNECTOR	CONNECTEUR 6 VOIES FEMELLE	6-WEGE-VERBINDER BUCHSE	CONECTOR 6 VÍAS HEMBRA



Main color codes:  J1 - JLG Cream,  J2 - JLG Orange,  C4 - Green



 IMPIANTO ELETTRICO
 ELECTRICAL SYSTEM
 INSTALLATION ÉLECTRIQUE





ELEKTRISCHE ANLAGE 
 INSTALACIÓN ELÉCTRICA 



POS	Codice	 Descrizione	 Description	 Designation	 Benennung	 Descripción
21	1730720042	PIASTRA BLOCCAGGIO CONNETTORE 6 VIE FEMMINA	CONNECTOR	CONNECTEUR	VERBINDER	CONECTADOR
22	1772950007	PUNTALINO FEMMINA PER 48XS CAVO 0,5-1	FERRULE FEMALE 48XS 0,5-1	BORNE	KLEMME	BORNE
23	1757250031	CONNETTORE SUPERSEAL PF 2 VIE	CONNECTOR	CONNECTEUR	VERBINDER	CONECTADOR
24	1757250032	CONNETTORE SUPERSEAL PM 2 VIE	CONNECTOR	CONNECTEUR	VERBINDER	CONECTADOR
25	1757250033	CAPPUCCIO POSTERIOERE CONNETTORE SUPERSEAL 2 VIE	CAP	CAPUCHON	KAPPE	CAPUCHO
26	1757250043	GOMMINO TENUTA PER CAVI CONNETTORI SUPERSEAL	RUBBER SEAL	JOINT EN CAOUTCHOUC	GUMMIDICHTUNG	JUNTA DE GOMA
27	1757250035	CONNETTORE SUPERSEAL PM 3 VIE	CONNECTOR	CONNECTEUR	VERBINDER	CONECTADOR
28	1757250034	CONNETTORE SUPERSEAL PF 3 VIE	CONNECTOR	CONNECTEUR	VERBINDER	CONECTADOR
29	1757250036	CAPPUCCIO POSTERIOERE CONNETTORE SUPERSEAL 3 VIE	CAP	CAPUCHON	KAPPE	CAPUCHO
30	1757250038	CONNETTORE SUPERSEAL PM 4 VIE	CONNECTOR	CONNECTEUR	VERBINDER	CONECTADOR
31	1757250037	CONNETTORE SUPERSEAL PF 4 VIE	CONNECTOR	CONNECTEUR	VERBINDER	CONECTADOR



Main color codes:  J1 - JLG Cream,  J2 - JLG Orange,  C4 - Green



 IMPIANTO ELETTRICO
 ELECTRICAL SYSTEM
 INSTALLATION ÉLECTRIQUE





ELEKTRISCHE ANLAGE 
 INSTALACIÓN ELÉCTRICA 



POS	Codice	 Descrizione	 Description	 Designation	 Benennung	 Descripción
32	1757250039	CAPPUCCIO POSTERIORE CONNETTORE SUPERSEAL 4 VIE	CAP	CAPUCHON	KAPPE	CAPUCHO
33	1757250041	CONNETTORE SUPERSEAL PM 5 VIE	CONNECTOR	CONNECTEUR	VERBINDER	CONECTADOR
34	1757250040	CONNETTORE SUPERSEAL PF 5 VIE	CONNECTOR	CONNECTEUR	VERBINDER	CONECTADOR
34	1757250056	CONNETTORE SUPERSEAL PF 6 VIE	CONNECTOR	CONNECTEUR	VERBINDER	CONECTADOR
35	1757250042	CAPPUCCIO POSTERIOERE CONNETTORE SUPERSEAL 5 VIE	CAP	CAPUCHON	KAPPE	CAPUCHO
35	1757250057	CAPPUCCIO POSTERIOERE CONNETTORE SUPERSEAL 6-7 VIE	CAP	CAPUCHON	KAPPE	CAPUCHO
36	1757250046	GOMMINO TENUTA TAPPO PER CONNETTORI SUPERSEAL	RUBBER SEAL	JOINT EN CAOUTCHOUC	GUMMIDICHTUNG	JUNTA DE GOMA
37	1757250044	CONNETTORE JPT 2 VIE PER ELETTROVALVOLE	CONNECTOR	CONNECTEUR	VERBINDER	CONECTADOR
38	1757250045	GOMMINO TENUTA PER CAVI CONNETTORI JPT	RUBBER SEAL	JOINT EN CAOUTCHOUC	GUMMIDICHTUNG	JUNTA DE GOMA
39	1772950001	PUNTALINO FEMMINA PER X580 CAVO SEZ 0,75-1	FERRULE FEMALE X580 0,75-1	BORNE	KLEMME	BORNE
39	1772950002	PUNTALINO FEMMINA PER X580 CAVO SEZ 0,5	FERRULE FEMALE X580 0,5	BORNE	KLEMME	BORNE



Main color codes:  J1 - JLG Cream,  J2 - JLG Orange,  C4 - Green



 IMPIANTO ELETTRICO
 ELECTRICAL SYSTEM
 INSTALLATION ÉLECTRIQUE





ELEKTRISCHE ANLAGE 
 INSTALACIÓN ELÉCTRICA 



POS	Codice	 Descrizione	 Description	 Designation	 Benennung	 Descripción
39	1772950003	PUNTALINO FEMMINA PER X580 CAVO SEZ 1,5	FERRULE FEMALE X580 1,5	BORNE	KLEMME	BORNE
39	1772950004	PUNTALINO FEMMINA PER X580 CAVO SEZ 2,5	FERRULE FEMALE X580 2,5	BORNE	KLEMME	BORNE
40	1772950010	CONNETTORE PER 48XS 52 POLI	CONNECTOR FOR 48XS 52P	CONNECTEUR	VERBINDER	CONECTADOR
41	1730720059	CONNETTORE 29 VIE F MOTORE (X26)	CONNECTOR	CONNECTEUR	VERBINDER	CONECTADOR
42	1772950008	PUNTALINO FEMMINA PER 48XS CAVO 1,5	FERRULE FEMALE 48XS 1,5	BORNE	KLEMME	BORNE
43	17473600	PARTE DI CONNETTORE 24VIE	CONNECTOR PART 24 WAY	CONNECTEUR	VERBINDER	CONECTADOR
44	17473700	SLITTA PER CONNETTORE 24 VIE	SLIDE FOR 24-WAY CONNECTOR	COULISSEAU	SCHLITTEN	CORREDERA
45	17306300	PUNTALINO FEMMINA PER CONNETTORE 56 VIE SCHEDE MASTER D=1.5	FERRULE FEMALE CONNECTOR 56 WAY MAIN BOARD D = 1.5	BUTÉE FEMELLE CONNECTEUR 56 VOIES CARTE MASTER D = 1.5	AUFLAGESTIFT BUCHSE 56-WEGE-VERBINDER MASTERPLATINE D = 1.5	CONECTOR PUNTA HEMBRA 56 VÍAS TARJETA MASTER D=1,5
46	17473800	PUNTALINO FEMMINA PER CONNETTORE 24 VIE SCHEDE CELLA DI CARICO D=2.8	FERRULE FEMALE CONNECTOR 24 WAY BOARD LOAD CELL D = 2.8	EMBOUT FEMELLE POUR CONNECTEUR 24 VOIES CARTE CELLULE DE CHARGE D=2.8	VERSCHRAUBUNG BUCHSE FÜR 24-WEGE-VERBINDER KORBLAST-PLATINE D=2,8	PUNTAL HEMBRA PARA CONECTOR 24 VÍAS CELULA DE CARGA D=2.8
48	1730720083	CUSTODIA 3 POLI GRIGIA VOLANTE PER CONN.PM 4+1VIE 230/110V (X29)	HOUSING 3 POLE GREY FOR CONN. PM 4 + 1 WAY 230V / 110V (X29)	LOGEMENT	GEHÄUSE	ALOJAMIENTO
49	1730720082	FRUTTO CONN.PM 4+1VIE 230/110V (X29)	CONNECTOR PM 4 + 1 WAY 230V / 110V (X29)	CONNECTEUR	VERBINDER	CONECTADOR



Main color codes:  J1 - JLG Cream,  J2 - JLG Orange,  C4 - Green



 IMPIANTO ELETTRICO
 ELECTRICAL SYSTEM
 INSTALLATION ÉLECTRIQUE





ELEKTRISCHE ANLAGE 
 INSTALACIÓN ELÉCTRICA 



POS	Codice	 Descrizione	 Description	 Designation	 Benennung	 Descripción
50	1730720080	FRUTTO CONN. PF 4+1 VIA 230/110V (X29)	CONNECTOR PF 4 + 1 WAY 230V / 110V (X29)	CONNECTEUR	VERBINDER	CONECTADOR
51	1730720081	CUSTODIA 3 POLI GRIGIA CON GANCIO PER CONN. PF 4+1 VIA 230/110V (X29)	HOUSING 3 POLE GREY WITH HOOK FOR CONN. PF 4 + 1 ROUTE 230 / 110V (X29)	LOGEMENT	GEHÄUSE	ALOJAMIENTO
52	1730720032	TERMINALE MASCHIO CAVO 0.75-1.5	TERMINAL MALE CABLE 0.75-1.5	MALE TERMINAL	TERMINAL MALE	MALE TERMINAL
52	1730720036	TERMINALE FEMMINA CONNETTORE M CAVO 0.5-1	TERMINAL FEMALE MALE CONNECTOR CABLE 0.5-1	BORNE FEMELLE	TERMINAL FEMALE	TERMINAL HEMBRA
52	1730720040	TERMINALE FEMMINA (X24)	TERMINAL FEMALE (X24)	BORNE FEMELLE (X24)	TERMINAL FEMALE (X24)	TERMINAL HEMBRA (X24)
52	1730720043	TERMINALE MASCHIO (X24) DA 0.5 A 0.75	TERMINAL MALE (X24) DA 0.5 A 0.75	BORNE MALE (X24)	TERMINAL MALE (X24)	TERMINAL MACHO (X24)
52	1730720055	CONTATTO MASCHIO 25A CAVO 2.5-4	CONTACT MALE 25A CABLE 2.5-4	CONTACT MALE 25A	CONTACT MALE 25A	CONTACT MALE 25A
52	1730720056	TAPPO SIZE 12-16 (X26)	CAP SIZE 12-16 (X26)	CAP TAILLE 12-16 (X26)	CAP SIZE 12-16 (X26)	CAP TAMAÑO 12-16 (X26)
52	1730720057	TAPPO SIZE 16 (X26)	CAP SIZE 16 (X26)	PLUG SIZE 16 (X26)	PLUG SIZE 16 (X26)	MACHO TALLA 16 (X26)
52	1730720058	CONTATTO MASCHIO 7.5A (X26)	CONTACT PIN 7.5A (X26)	CONTACT PIN 7.5A (X26)	CONTACT PIN 7.5A (X26)	CONTACT 7.5A (X26)
52	1730720061	CONTATTO FEMMINA 7.5A (X26)	CONTACT FEMALE 7.5A (X26)	CONTACTER 7,5 FEMELLE (X26)	CONTACT FEMALE 7.5A (X26)	CONTACT 7.5A FEMENINO (X26)
52	1730720068	TAPPO SIZE 20 (X1)	CAP SIZE 20 (X1)	PLUG SIZE 20 (X1)	PLUG SIZE 20 (X1)	TAMAÑO DE ENCHUFE 20 (X1)



Main color codes:  J1 - JLG Cream,  J2 - JLG Orange,  C4 - Green

 IMPIANTO ELETTRICO
 ELECTRICAL SYSTEM
 INSTALLATION ÉLECTRIQUE



ELEKTRISCHE ANLAGE 
 INSTALACIÓN ELÉCTRICA 



POS	Codice	 Descrizione	 Description	 Designation	 Benennung	 Descripción
52	1730720069	CONTATTO FEMMINA 25A CONNETTORE M CAVO 2.5-4	CONTACT FEMALE 25A MALE CONNECTOR CABLE 2.5-4	CONTACT FEMELLE 25A	KONTAKT BUCHSE 25A	CONTACT HEMBRA 25A
53	1757250048	PUNTALINO FEMMINA PER SUPERSEAL	FERRULE FEMALE FOR SUPERSEAL	FERRULE	NUTMUTTER	ANILLO
56	1757250049	PUNTALINO MASCHIO PER SUPERSEAL	FERRULE MALE FOR SUPERSEAL	FERRULE	NUTMUTTER	ANILLO
57	1739150047	CONTATTO FEMMINA PER CONNETTORE JPT	CONTACT FEMALE FOR CONNECTOR JPT	CONTACT FEMELLE POUR CONNECTEUR JPT	KONTAKT BUCHSE FÜR JPT VERBINDER	CONTACTO HEMBRA PARA CONECTOR JPT

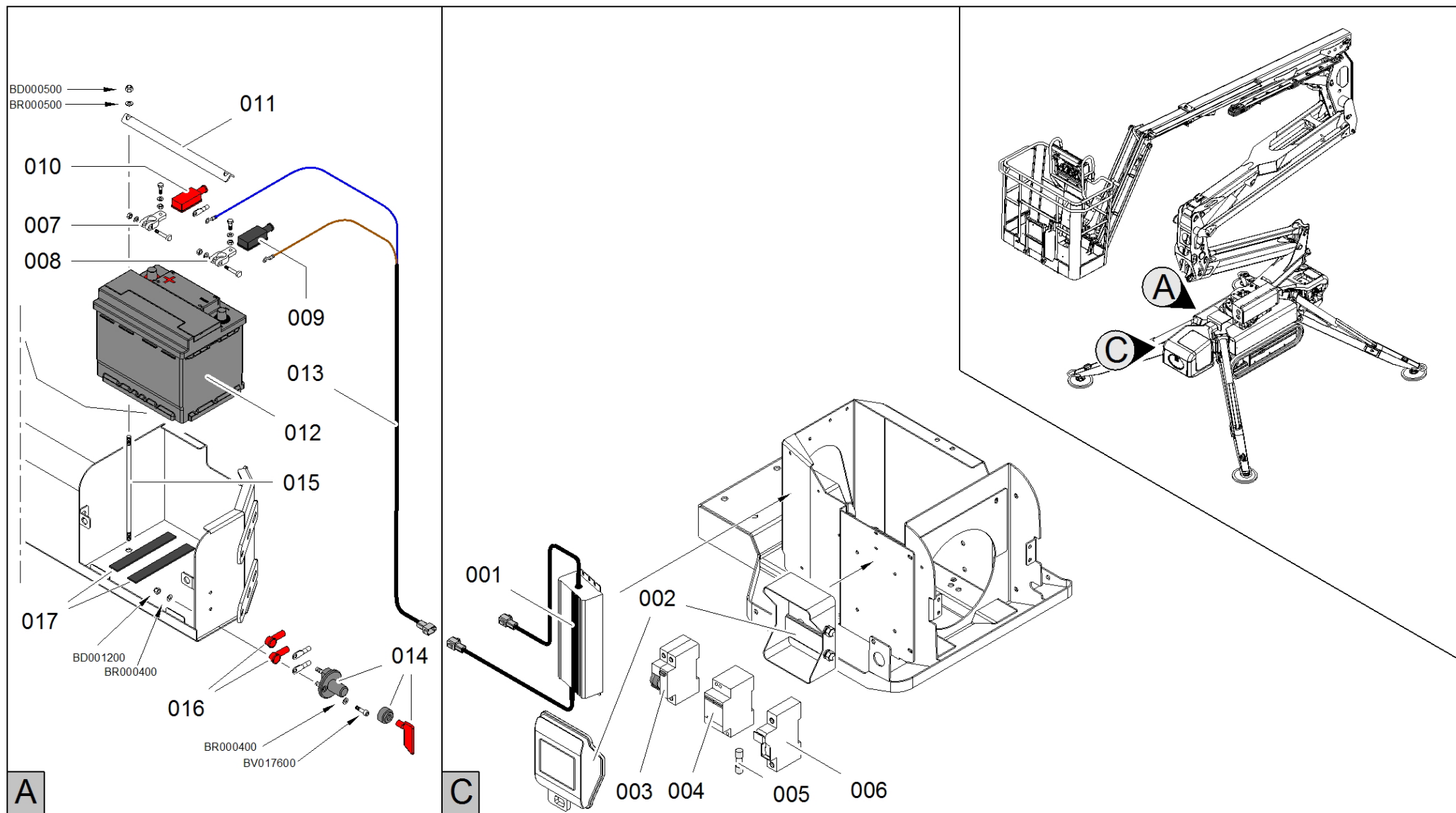

 IMPIANTO ELETTRICO
 ELECTRICAL SYSTEM
 INSTALLATION ÉLECTRIQUE





ELEKTRISCHE ANLAGE 
 INSTALACIÓN ELÉCTRICA 









Main color codes:  J1 - JLG Cream,  J2 - JLG Orange,  C4 - Green



 IMPIANTO ELETTRICO
 ELECTRICAL SYSTEM
 INSTALLATION ÉLECTRIQUE





ELEKTRISCHE ANLAGE 
 INSTALACIÓN ELÉCTRICA 

POS	Codice	 Descrizione	 Description	 Designation	 Benennung	 Descripción
1	1757250007	ALIMENTATORE ELETTRONICO 285W REGOLABILE IP65 PER BATTERIE 55-75 AH COMPLETO DI CONNETTORI	ELECTRONIC BALLAST	ALIMENTATEUR ÉLECTRONIQUE	ELEKTRONISCHES NETZGERÄT	ALIMENTADOR ELETRÓNICO
2	1757250008	SCATOLA ELETTRICO PLASTICA 6 MODULI BI COPERCHIO TRASPARENTE	ELECTRICAL BOX	BOÎTE ÉLECTRIQUE	SCHALTKASTEN	CAJA ELÉCTRICA
3	1556350063	INTERUTTORE AUTOMATICO MAGNETOTERMICO 110-120V 25A (FINO A C170000355 MONTATO C16 SU MACCHINE 120V)	AUTOMATIC THERMAL SWITCH 110-120V 25A (UNTIL C170000355 MOUNTED C16 ON 120V MACHINES)	INTERRUPTEUR	SCHALTER	INTERRUPTOR
4	1757250006	TELERUTTORE 4POLI 63A CA/CC	RELAY	RELAIS	RELAIS	RELÉ
5	1730720017	FUSIBILE A TUBO 10A	TUBE FUSE 10A	FUSIBLE	SICHERUNG	FUSIBLE
6	1730720015	PORTAFUSIBILE A TUBO 220/110V	FUSE HOLDER TUBE 220/110V	BOÎTE À FUSIBLES	SICHERUNGSKASTEN	PORTAFUSIBLES
7	1739150023	MORSETTO POSITIVO A C PER BATTERIA M10	POSITIVE BATTERY CLAMP "C" M10	BORNE POSITIVE A C POUR BATTERIE M10	POSITIVE KLEMME FÜR BATTERIE M10	BORNE POSITIVO A C PARA BATERÍA M10
8	1739150025	MORSETTO NEGATIVO A C PER BATTERIA M10	NEGATIVE BATTERY TERMINAL C M10	BORNE NEGATIVE A C POUR BATTERIE M10	NEGATIVE KLEMME FÜR BATTERIE M10	BORNE NEGATIVO A C PARA BATERÍA M10
9	2632920008	COPRI POLI BATTERIA QUADRATO NERO	POLE BATTERY COVER BLACK SQUARE	POLE BATTERIE COUVERTURE CARRÉ NOIR	POLE BATTERY COVER BLACK SQUARE	TAPAS BATERIA
10	2632920007	COPRI POLI BATTERIA QUADRATO ROSSO	POLE BATTERY COVER RED SQUARE	POLE CACHE BATTERIE RED SQUARE	POLE BATTERY COVER RED SQUARE	TAPAS DE LA BATERIA



Main color codes:  J1 - JLG Cream,  J2 - JLG Orange,  C4 - Green



 IMPIANTO ELETTRICO
 ELECTRICAL SYSTEM
 INSTALLATION ÉLECTRIQUE

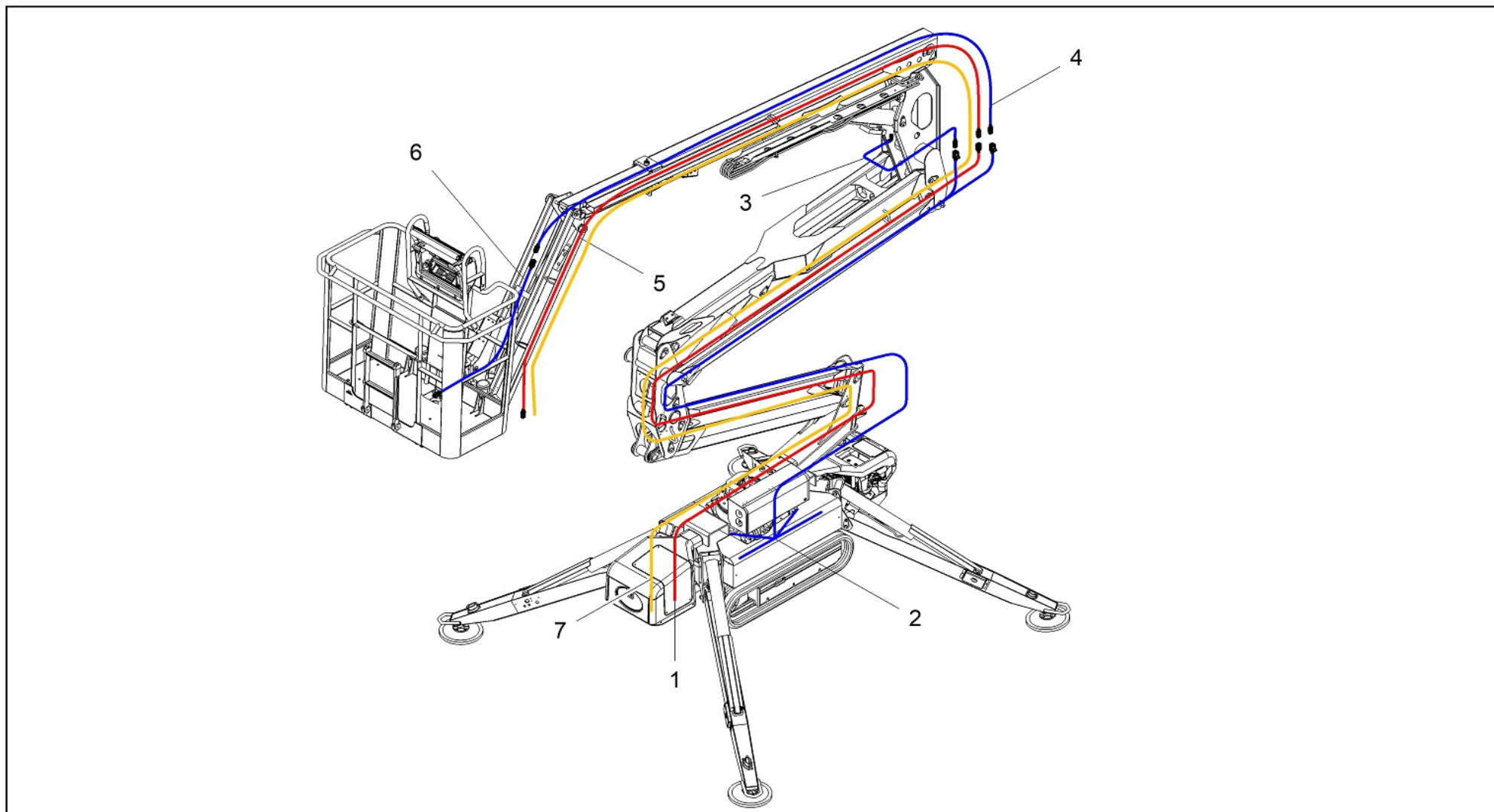

ELEKTRISCHE ANLAGE 
 INSTALACIÓN ELÉCTRICA 





POS	Codice	 Descrizione	 Description	 Designation	 Benennung	 Descripción
11	077483Y1	PIEGATO FISSAGGIO BATTERIA LL1570	BENT FIXING BATTERY LL1570	SUPPORT	HALTERUNG	SOPORTE
12	27668600	BATTERIA AGM S&S 12V 60AH 680A L02	BATTERY AGM S&S 12V 60AH 680A L02	BATTERIE AGM S&S 12V 60AH 680A L02	BATTERIE AGM S&S 12V 60AH 680A L02	BATERÍA AGM S&S 12V 60AH 680A L02
13	17572600081	CONNETTORE DEUTSCH 2 VIE COMPLETO DI DIODO CON PROTEZIONE	DEUTSCH CONNECTOR 2 WAYS OF COMPLETE WITH PROTECTION DIODE	CONNECTEUR	VERBINDER	CONECTOR
13	1772950020	LINEA DA ALIMENTATORE A BATTERIA COMPLETA DI CONNETTORI E DIODO LL1570-X15JP- X430AJ	LINE FROM CHARGER TO BATTERY WITH CONNECTORS AND DIODE LL1570-X15JP- X430AJ	LIGNE	LEITUNG	LÍNEA
14	04774900	STACCA BATTERIA	BATTERY CUT-OFF DEVICE	COUPE BATTERIE	BATTERIETRENNSCH ALTER	CORTA-BATERÍA
15	06551000	TIRANTE	TIE ROD	TIRANT	TURMGESTÄNGE	TIRANTE
16	1733730029	COPRIPOLO BATTERIA ROSSO GRANDE	BIG RED COVER FOR BATTERY POLE	PROTECTION PÔLE ROUGE GRAND	ROTE POLKAPPE BATTERIE	CUBREPOLO BATERÍA ROJO GRANDE









Main color codes:  J1 - JLG Cream,  J2 - JLG Orange,  C4 - Green



 IMPIANTO ELETTRICO
 ELECTRICAL SYSTEM
 INSTALLATION ÉLECTRIQUE

ELEKTRISCHE ANLAGE 
 INSTALACIÓN ELÉCTRICA 



POS	Codice	 Descrizione	 Description	 Designation	 Benennung	 Descripción
1	1772980001	CAVO PROLUNGA 220-110V DA BASE A PRIMO BRACCIO LL1570 TTC CONNETTORI SOURIAU	EXTENSION CABLE 220-110V FROM BASE TO FIRST BOOM LL1570 TTC CONNECTORS SOURIAU	CÂBLE	KABEL	CABLE
2	17729500	KIT ELETTRICO	ELECTRIC KIT	KIT COMPOSANTS ÉLECTRIQUES	SATZ ELEKTRISCHE BAUTEILE	KIT COMPONENTES ELÉCTRICOS
3	1730720094	CAVO COMPLETO PER SENSORE DI POSIZIONE 3 CILINDRO BRACCIO	CABLE ASSEMBLY FOR POSITION SENSOR 3 BOOM CYLINDER	CÂBLE COMPLET POUR CAPTEUR DE POSITION 3° CYLINDRE BRAS	KABEL KOMPLETT FÜR POSITIONSSENSOR 3. AUSLEGERARM- ZYLINDER	CABLE COMPLETO PARA SENSOR DE POSICIÓN 3ERO CILINDRO BRAZO
4	1772950014	CAVO PROLUNGA 7 POLI SFILO LL1570- X15JP-X430AJ	EXTENSION CABLE 7 WIRES EXTENSION BOOM LL1570-X15JP- X430AJ	CÂBLE	KABEL	CABLE
5	1772950013	CAVO PROLUNGA 220-110V SFILO LL1570-X15JP-X430AJ	EXTENSION CABLE 220V-110V EXTENSION BOOM LL1570-X15JP-X430AJ	CÂBLE	KABEL	CABLE
6	1772980002	KIT ELETTRICO JIB LL1570-X15JP-X430AJ TTC (0A055075)	ELECTRIC KIT JIB LL1570-X15JP-X430AJ TTC (0A055075)	CÂBLE	KABEL	CABLE



Main color codes:  J1 - JLG Cream,  J2 - JLG Orange,  C4 - Green



 ADESIVI
 STICKER
 AUTOCOLLANT





AUFKLEBER 
PEGATINA 



DECALS LIST



Main color codes:  **J1** - JLG Cream,  **J2** - JLG Orange,  **C4** - Green

 ADESIVI
 STICKER
 AUTOCOLLANT



AUFKLEBER 
 PEGATINA 



POS	Codice	 Descrizione	 Description	 Designation	 Benennung	 Descripción
0	06039600	ADESIVO	STICKER	AUTOCOLLANT	AUFKLEBER	PEGATINA
0	06039700	ADESIVO	STICKER	AUTOCOLLANT	AUFKLEBER	PEGATINA
0	06040100	ADESIVO	STICKER	AUTOCOLLANT	AUFKLEBER	PEGATINA
0	06040300	ADESIVO	STICKER	AUTOCOLLANT	AUFKLEBER	PEGATINA
0	06040500	ADESIVO	STICKER	AUTOCOLLANT	AUFKLEBER	PEGATINA
0	06040900	ADESIVO	STICKER	AUTOCOLLANT	AUFKLEBER	PEGATINA
0	06041200	ADESIVO	STICKER	AUTOCOLLANT	AUFKLEBER	PEGATINA
0	06041300	ADESIVO	STICKER	AUTOCOLLANT	AUFKLEBER	PEGATINA
0	06041600	ADESIVO CARBURANTE BENZINA COLORE VERDE L=60 X 80 (**)	DECAL	AUTOCOLLANT	AUFKLEBER	PEGATINA
0	06042400	ADESIVO	STICKER	AUTOCOLLANT	AUFKLEBER	PEGATINA
0	06043900	ADESIVO	STICKER	AUTOCOLLANT	AUFKLEBER	PEGATINA
0	06056300	ADESIVO	STICKER	AUTOCOLLANT	AUFKLEBER	PEGATINA
0	06060000	ADESIVO	STICKER	AUTOCOLLANT	AUFKLEBER	PEGATINA
0	06085900	ADESIVO	STICKER	AUTOCOLLANT	AUFKLEBER	PEGATINA
0	06086000	ADESIVO	STICKER	AUTOCOLLANT	AUFKLEBER	PEGATINA
0	06086700	ADESIVO	STICKER	AUTOCOLLANT	AUFKLEBER	PEGATINA
0	06136900	ADESIVO PUNTI INGRASSAGGIO Ø 55 TESTO NERO - SFONDO BIANCO (**)	STICKER GREASE POINTS Ø 55	AUTOCOLLANT POINTS GRAISSANGE Ø 55 TEXTE NOIR - FOND BLANC (**)	AUFKLEBER SCHMIERPUNKTE Ø 55, SCHWARZER TEXT - WEIßER UNTERGRUND	PEGATINS PUNTOS ENGRASE Ø 55 TEXTO NEGRO - FONDO BLANCO (**)
0	06164600	ADESIVO	STICKER	AUTOCOLLANT	AUFKLEBER	PEGATINA
0	06164700	ADESIVO	STICKER	AUTOCOLLANT	AUFKLEBER	PEGATINA
0	06165000	ADESIVO	STICKER	AUTOCOLLANT	AUFKLEBER	PEGATINA
0	06207700	ADESIVO	STICKER	AUTOCOLLANT	AUFKLEBER	PEGATINA
0	06227200	ADESIVO "CONTROLLARE LIVELLO OLIO MOTORE " 7 LINGUE GIALLO L=82X108 (**)	DECAL	AUTOCOLLANT	AUFKLEBER	PEGATINA



 ADESIVI
 STICKER
 AUTOCOLLANT

AUFKLEBER 
 PEGATINA 



POS	Codice	 Descrizione	 Description	 Designation	 Benennung	 Descripción
0	06232100	ADESIVO	STICKER	AUTOCOLLANT	AUFKLEBER	PEGATINA
0	06254800	ADESIVO" STOP EMERGENZA" SFONDO GIALLO L=100X50 (**)	DECAL	AUTOCOLLANT	AUFKLEBER	PEGATINA
0	06448100	ADESIVO	STICKER	AUTOCOLLANT	AUFKLEBER	PEGATINA
0	06448200	ADESIVO	STICKER	AUTOCOLLANT	AUFKLEBER	PEGATINA
0	06506400	ADESIVO	STICKER	AUTOCOLLANT	AUFKLEBER	PEGATINA
0	06520600	ADESIVO	STICKER	AUTOCOLLANT	AUFKLEBER	PEGATINA
0	06555500	ADESIVO	STICKER	AUTOCOLLANT	AUFKLEBER	PEGATINA
0	06555600	ADESIVO	STICKER	AUTOCOLLANT	AUFKLEBER	PEGATINA
0	06555700	ADESIVO	STICKER	AUTOCOLLANT	AUFKLEBER	PEGATINA
0	06555800	ADESIVO	STICKER	AUTOCOLLANT	AUFKLEBER	PEGATINA
0	06561200	ADESIVO	STICKER	AUTOCOLLANT	AUFKLEBER	PEGATINA
0	06706500	ADESIVO	STICKER	AUTOCOLLANT	AUFKLEBER	PEGATINA
0	06840400	ADESIVO	STICKER	AUTOCOLLANT	AUFKLEBER	PEGATINA
0	06922700	ADESIVO	STICKER	AUTOCOLLANT	AUFKLEBER	PEGATINA
0	06998800	ADESIVO	STICKER	AUTOCOLLANT	AUFKLEBER	PEGATINA
0	07034200	ADESIVO	STICKER	AUTOCOLLANT	AUFKLEBER	PEGATINA
0	07050700	ADESIVO	STICKER	AUTOCOLLANT	AUFKLEBER	PEGATINA
0	07056300	ADESIVO	STICKER	AUTOCOLLANT	AUFKLEBER	PEGATINA
0	07056400	ADESIVO	STICKER	AUTOCOLLANT	AUFKLEBER	PEGATINA
0	07056700	ADESIVO	STICKER	AUTOCOLLANT	AUFKLEBER	PEGATINA
0	07056800	ADESIVO	STICKER	AUTOCOLLANT	AUFKLEBER	PEGATINA
0	07058800	ADESIVO	STICKER	AUTOCOLLANT	AUFKLEBER	PEGATINA
0	07060500	ADESIVO	STICKER	AUTOCOLLANT	AUFKLEBER	PEGATINA
0	07060600	ADESIVO	STICKER	AUTOCOLLANT	AUFKLEBER	PEGATINA
0	07071000	ADESIVO	STICKER	AUTOCOLLANT	AUFKLEBER	PEGATINA
0	07071200	ADESIVO	STICKER	AUTOCOLLANT	AUFKLEBER	PEGATINA
0	07194400	ADESIVO	DECAL	AUTOCOLLANT	AUFKLEBER	PEGATINA
0	07240300	ADESIVO	STICKER	AUTOCOLLANT	AUFKLEBER	PEGATINA



Main color codes:  J1 - JLG Cream,  J2 - JLG Orange,  C4 - Green



 ADESIVI
 STICKER
 AUTOCOLLANT

AUFKLEBER 
 PEGATINA 



POS	Codice	 Descrizione	 Description	 Designation	 Benennung	 Descripción
0	07264700	ADESIVO INDICATORE LED CARICABATTERIE 48V (Ø EST.31MM Ø INT.6 MM) VECCHIO BMS (FINO A C170000329)	DECAL	AUTOCOLLANT	AUFKLEBER	PEGATINA
0	07264800	ADESIVO	DECAL	AUTOCOLLANT	AUFKLEBER	PEGATINA
0	07268300	ADESIVO	DECAL	AUTOCOLLANT	AUFKLEBER	PEGATINA
0	07268400	ADESIVO	DECAL	AUTOCOLLANT	AUFKLEBER	PEGATINA
0	07394800	ADESIVO INDICATORE LED CARICABATTERIE 48V (Ø EST.31MM Ø INT.6 MM) NUOVO BMS/4 (DA C170000330)	DECAL	AUTOCOLLANT	AUFKLEBER	PEGATINA
0	07499300	ADESIVO DON'T OPEN THE CASE SFONDO GIALLO L=60X17 MM	DECAL	AUTOCOLLANT	AUFKLEBER	PEGATINA
0	076358GB	ADESIVO	DECAL	AUTOCOLLANT	AUFKLEBER	PEGATINA
0	07668000	ADESIVO PERICOLO 110 VOLT 32A GIALLO	DECAL	AUTOCOLLANT	AUFKLEBER	PEGATINA
0	07668100	ADESIVO PULSANTI DISTRIBUTORE PARTE AEREA LL2614 L=318X52 MM	DECAL	AUTOCOLLANT	AUFKLEBER	PEGATINA
0	07668200	ADESIVO EMERGENCY STOP E BLOCCHETTO ACCENSIONE L=85X160 MM	DECAL	AUTOCOLLANT	AUFKLEBER	PEGATINA
0	07668300	ADESIVO	DECAL	AUTOCOLLANT	AUFKLEBER	PEGATINA
0	07669000	ADESIVO	DECAL	AUTOCOLLANT	AUFKLEBER	PEGATINA
0	07669100	ADESIVO	DECAL	AUTOCOLLANT	AUFKLEBER	PEGATINA
0	07676200	ADESIVO	DECAL	AUTOCOLLANT	AUFKLEBER	PEGATINA



Main color codes:  J1 - JLG Cream,  J2 - JLG Orange,  C4 - Green



 ADESIVI
 STICKER
 AUTOCOLLANT





AUFKLEBER 
 PEGATINA 

POS	Codice	 Descrizione	 Description	 Designation	 Benennung	 Descripción
0	07690100	ADESIVO	DECAL	AUTOCOLLANT	AUFKLEBER	PEGATINA
0	07691500	ADESIVO	DECAL	AUTOCOLLANT	AUFKLEBER	PEGATINA
0	07787800	ADESIVO	STICKER	AUTOCOLLANT	AUFKLEBER	PEGATINA
0	07788500	ADESIVO	DECAL	AUTOCOLLANT	AUFKLEBER	PEGATINA
0	07799200	ADESIVO	DECAL	AUTOCOLLANT	AUFKLEBER	PEGATINA
0	07799400	ADESIVO	DECAL	AUTOCOLLANT	AUFKLEBER	PEGATINA
0	07802200	ADESIVO RUMORE 102 DB L=90X100 MM	STICKER NOISE 102 DB L = 90 X 100 MM	AUTOCOLLANT	AUFKLEBER	PEGATINA
0	07808100	ADESIVO	DECAL	AUTOCOLLANT	AUFKLEBER	PEGATINA
0	07839500	ADESIVO	DECAL	AUTOCOLLANT	AUFKLEBER	PEGATINA
0	07878400	ADESIVO CASCO IMBRAGATURA E DIVIETI LL1370 L=175X118 MM	STICKER HELMET HARNESS AND BANS	AUTOCOLLANT CASQUE HARNAIS ET INTERDICTION	STICKER HELMGURT UND VERBOTE	ETIQUETA ARNÉS CASCO Y PROHIBICIONES
0	08069800	ADESIVO	STICKER	AUTOCOLLANT	AUFKLEBER	PEGATINA
0	08347400	STRISCIA BIANCA E ROSSA	DECAL	AUTOCOLLANT	AUFKLEBER	PEGATINA
0	08347500	STRISCIA BIANCA E ROSSA	DECAL	AUTOCOLLANT	AUFKLEBER	PEGATINA
0	1001125483	ADESIVO	STICKER	AUTOCOLLANT	AUFKLEBER	PEGATINA
0	1001223055	ADESIVO ISPEZIONE ANNUALE	DECAL YEARLY INSPECTION	INSPECTION ANNUELLE DES DÉCALQUES	AUFKLEBER JAHRESKONTROLLE	INSPECCIÓN ANUAL DE LA CALCOMANÍA
0	1001223453	ADESIVO NORMATIVA CANADESE ICES-002	CANADIAN REGULATIONS DECAL ICES-002	AUTOCOLLANT RÉGLEMENTAIRE CANADIEN ICES-002	KANADISCHE VORSCHRIFT AUFKLEBER	PEGATINA REGULATORIO CANADIENSE
0	1001228370	ADESIVO NORMATIVA CANADESE ICES-001	CANADIAN REGULATIONS DECAL ICES-001	AUTOCOLLANT RÉGLEMENTAIRE CANADIEN ICES-001	KANADISCHE VORSCHRIFTEN AUFKLEBER ICES-001	PEGATINA REGULATORIO CANADIENSE ICES- 001
0	1608710001	ADESIVO	STICKER	AUTOCOLLANT	AUFKLEBER	PEGATINA
0	1608710002	ADESIVO	STICKER	AUTOCOLLANT	AUFKLEBER	PEGATINA
0	1701504	ADESIVO	STICKER	AUTOCOLLANT	AUFKLEBER	PEGATINA
0	1701505	ADESIVO	STICKER	AUTOCOLLANT	AUFKLEBER	PEGATINA

Main color codes:  J1 - JLG Cream,  J2 - JLG Orange,  C4 - Green

 ADESIVI
 STICKER
 AUTOCOLLANT

AUFKLEBER 
 PEGATINA 

POS	Codice	 Descrizione	 Description	 Designation	 Benennung	 Descripción
0	1701640	ADESIVO	STICKER	AUTOCOLLANT	AUFKLEBER	PEGATINA
0	1701644	ADESIVO JLG CAVO CARICABATTERIA	STICKER JLG CABLE CHARGER	AUTOCOLLANT	AUFKLEBER	PEGATINA
0	1702155	ADESIVO	STICKER	AUTOCOLLANT	AUFKLEBER	PEGATINA
0	1703813	ADESIVO	STICKER	AUTOCOLLANT	AUFKLEBER	PEGATINA
0	1703814	ADESIVO	STICKER	AUTOCOLLANT	AUFKLEBER	PEGATINA
0	1704125	ADESIVO	DECAL	AUTOCOLLANT	AUFKLEBER	PEGATINA
0	1704277	ADESIVO	STICKER	AUTOCOLLANT	AUFKLEBER	PEGATINA
0	1705828	ADESIVO	STICKER	AUTOCOLLANT	AUFKLEBER	PEGATINA
0	1706098	ADESIVO	STICKER	AUTOCOLLANT	AUFKLEBER	PEGATINA
0	1706385	ADESIVO	STICKER	AUTOCOLLANT	AUFKLEBER	PEGATINA
0	1706493	ADESIVO	STICKER	AUTOCOLLANT	AUFKLEBER	PEGATINA
0	1848760001	ADESIVO PER MACCHINE CON OLIO BIODEGRADABILE	STICKER FOR MACHINES WITH OIL BIODEGRADABLE	AUTOCOLLANT	AUFKLEBER	PEGATINA

Cod. 17107300

KIT INTEGRAZIONE ADESIVI PER PIATTAFORME AEREE LITHIUM-ANSI
INTEGRATION KIT STICKERS PLATFORMS LITHIUM-ANSI

X370AJ • X390AJ • X430AJ • X500AJ • X550AJ • X600AJ • X700AJ • X770AJ

Da usare in aggiunta ai seguenti kit di sicurezza /
To use in addition to the following safety kit

X370AJcod.17788300
X390AJcod.17065200
X430AJ.....cod.17788300
X500AJ / MK2.....cod. 17776800
X550AJ.....cod. 17065300
X600AJ / MK2.....cod. 17777000
X700AJ.....cod. 17065400
X770AJ.....cod. 17633600

+ kit in lingua non inclusi nel codice generale / language code not included in the standard kit

+171073GB + 171073FR + 171073ES + 171073PT

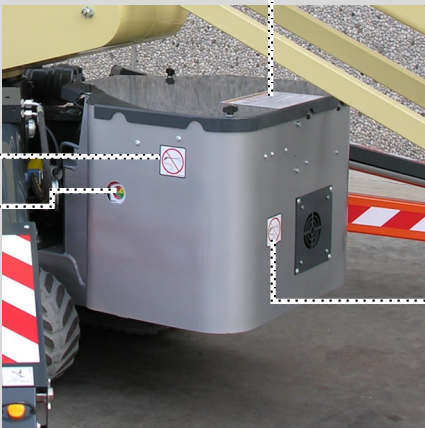

KIT ADESIVI - X390AJ

SET OF DECALS - X390AJ

KIT COLLANTS - X390AJ

AUFKLEBERSATZ - X390AJ

KIT ADHESIVOS - X390AJ

ADHESIEKIT - X390AJ

cod. 17107300

Tav 01

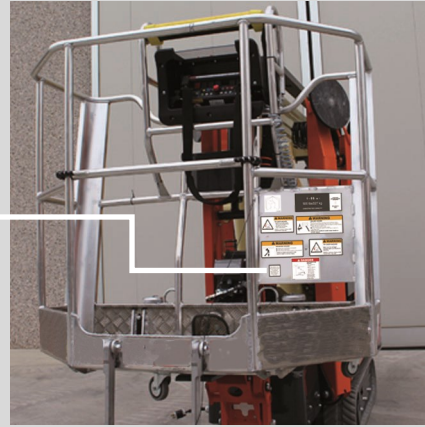
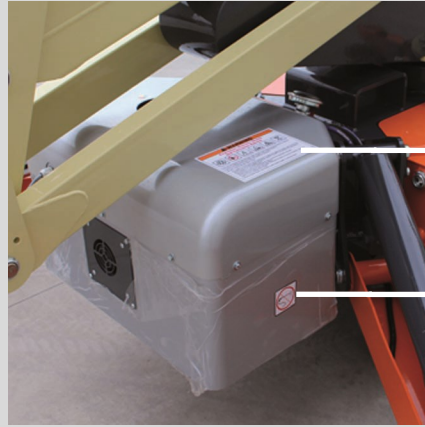
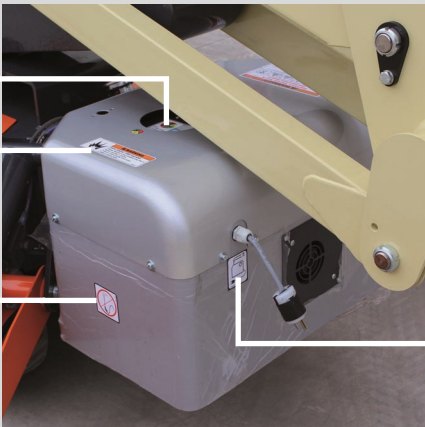
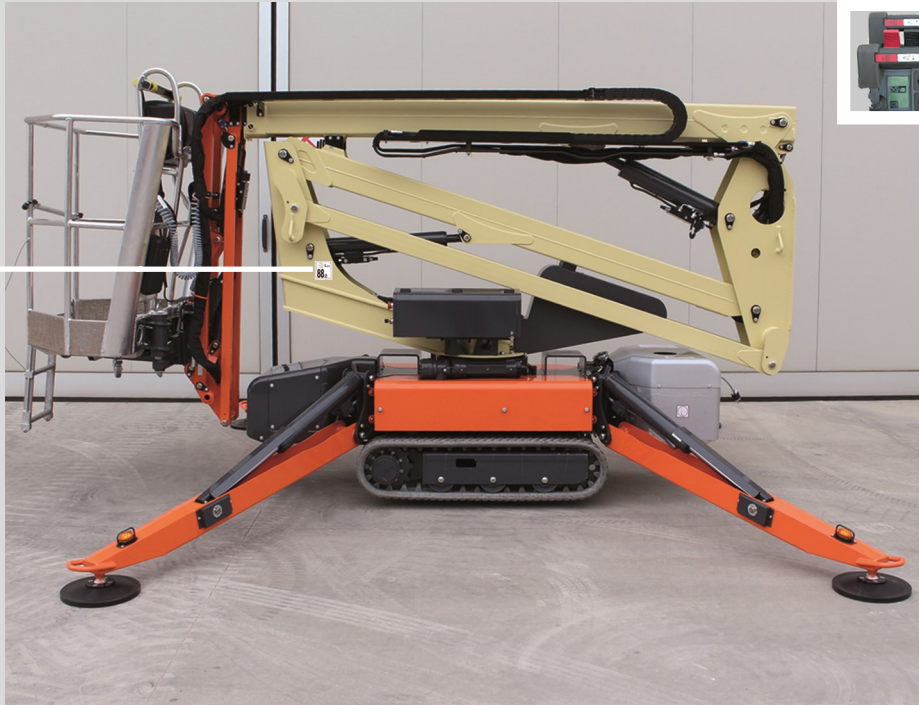

KIT ADESIVI - X370AJ / X430AJ

SET OF DECALS - X370AJ / X430AJ

KIT COLLANTS - X370AJ / X430AJ

AUFKLEBERSATZ - X370AJ / X430AJ

KIT ADHESIVOS - X370AJ / X430AJ

ADHESIEKIT - X370AJ / X430AJ

cod. 17107300

Tav 01



11



3

3

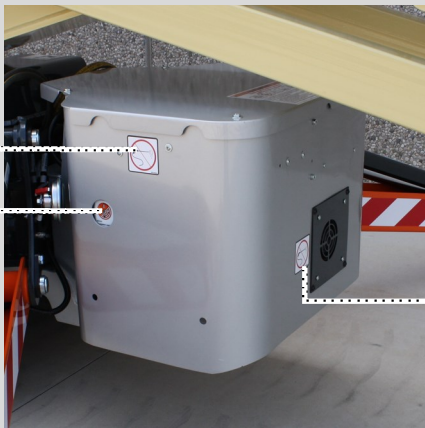

1

4

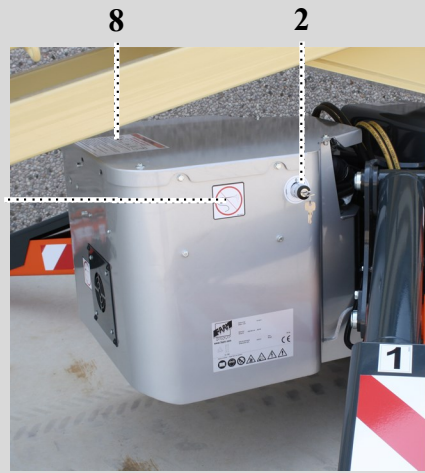

8

2

1

1

1

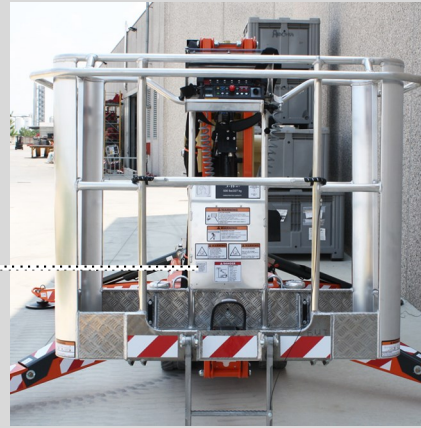

9

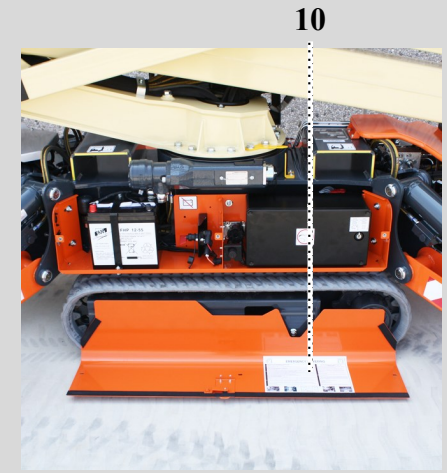

10

KIT ADESIVI - X500AJ

SET OF DECALS - X500AJ

KIT COLLANTS - X500AJ

AUFKLEBERSATZ - X500AJ

KIT ADHESIVOS - X500AJ

ADHESIEKIT - X500AJ

cod. 17107300

Tav 01



KIT ADESIVI - X600AJ

SET OF DECALS - X600AJ

KIT COLLANTS - X600AJ

AUFKLEBERSATZ - X600AJ

KIT ADHESIVOS - X600AJ

ADHESIEKIT - X600AJ

cod. 17107300

Tav 01



11

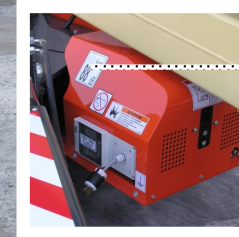

Sotto il coperchio /
under the cover

3

3



8



2

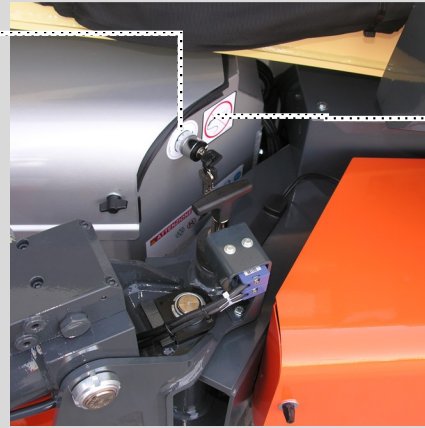

1

9

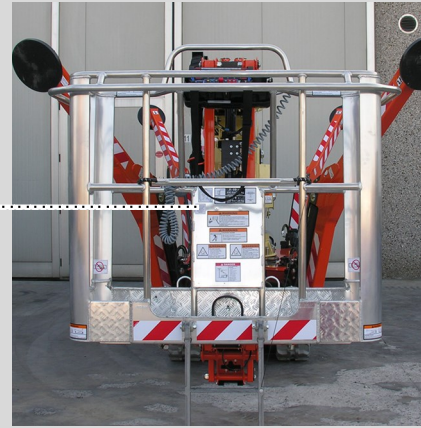

5 5 1

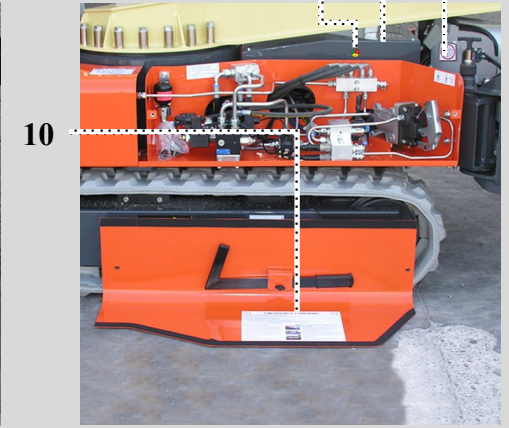

10

KIT ADESIVI - X700AJ

SET OF DECALS - X700AJ

KIT COLLANTS - X700AJ

AUFKLEBERSATZ - X700AJ

KIT ADHESIVOS - X700AJ

ADHESIEKIT - X700AJ

cod. 17107300

Tav 01



Sotto il coperchio /
under the cover

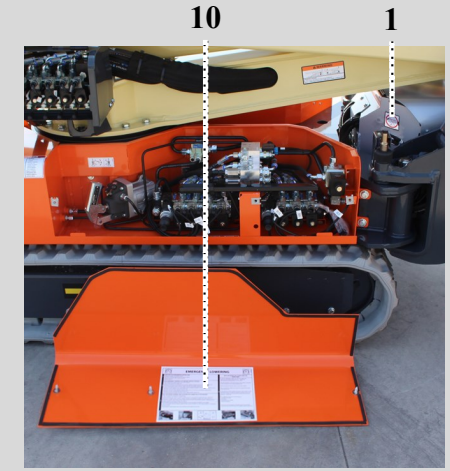
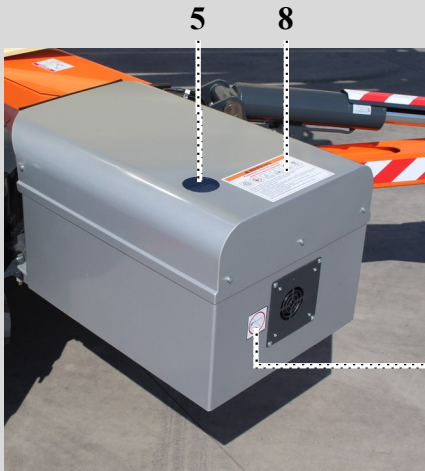

KIT ADESIVI - X770AJ

SET OF DECALS - X770AJ

KIT COLLANTS - X770AJ

AUFKLEBERSATZ - X770AJ

KIT ADHESIVOS - X770AJ

ADHESIEKIT - X770AJ

cod. 17107300

Tav 01

POS.	COD.	DESCRIZIONE / DESCRIPTION	Q.tà
01	1001125483	ADESIVO JLG VIETATO LAVARE L=63,5X63,5 MM	03
02	06506400	ADESIVO " CHIAVE DI ACCENSIONE" ESTERNO Ø 49 FORO Ø 22 SERIE LITHIUM ION _MOD_B (**)	01
03	06520600	ADESIVO RUMORE 88 dB L=90x100 MM _MOD_B (**)	02
04	07264700	ADESIVO INDICATORE LED CARICABATTERIE 48V (Ø EST.31MM Ø INT.6 MM) VECCHIO BMS (FINO A C170000329)	01
	07394800	ADESIVO INDICATORE LED CARICABATTERIE 48V (Ø EST.31MM Ø INT.6 MM) NUOVO BMS/4 (DA C170000330)	01
05	07264800	ADESIVO INDICATORE LED RICARICA BATTERIE Ø EST.21MM Ø INT.4 MM	02
06	1701644	ADESIVO JLG CAVO CARICABATTERIA L: 50,8X63,5 MM	01
07	1703813	ADESIVO JLG PERICOLO ESPLOSIONE BATTERIE - ING L=149,25X47,62 MM	01
08			
09			
10			
11	07194400	ADESIVO BOLLINO PER TELECOMANDO SERE IIIS COLORE GRIGIO Ø 10,50 MM	03
12			
13			
14			
15			
16			
17			
18			
19			
20			
21			

Cod. 17187700

KIT INTEGRAZIONE ADESIVI PER PIATTAFORME AEREE LITHIUM-CE /
INTEGRATION KIT STICKERS PLATFORMS LITHIUM-CE

X14J - X17J - X19J - X23J

X13JPLUS - X15JPLUS - X17JPLUS - X20JPLUS - X26JPLUS

Da usare in aggiunta a / To use in added to

X14J - cod.17063500

X14J-H - cod.17065000

X17J cod.17063700

X19J cod.17063200

X23J cod.17062700

X13JPLUS cod. 17788100

X15JPLUS cod. 17788100

X17JPLUS cod. 17242800

X20JPLUS cod. 17351800

X26JPLUS cod. 17633400

+ kit in lingua non inclusi nel codice generale + language code not included in the standard kit

171877IT / 171877GB / 171877FR / 171877DE / 171877ES / 171877NL / 171877SW / 171877PT /
171877DA / 171877NO / 171877RU / 171877PL / 171877SL / 171877FI / 171877CE / 171877JA



KIT ADESIVI X14J LITHIUM
 SET OF DECALS X14J LITHIUM
 KIT COLLANTS X14J LITHIUM

AUFKLEBERSATZ X14J LITHIUM
 KIT ADHESIVOS X14J LITHIUM
 ADHESIEKIT X14J LITHIUM

cod. 17187700

Tav 01



9



8

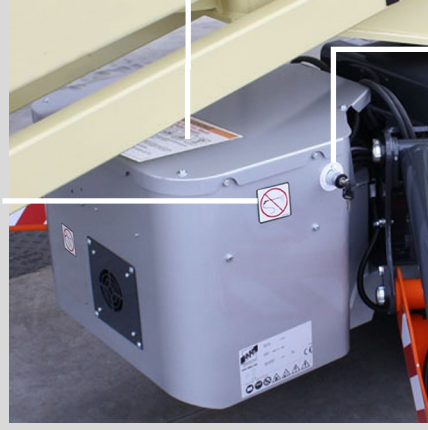

2



KIT ADESIVI X17J LITHIUM

SET OF DECALS X17J LITHIUM

KIT COLLANTS X17J LITHIUM

AUFKLEBERSATZ X17J LITHIUM

KIT ADHESIVOS X17J LITHIUM

ADHESIEKIT X17J LITHIUM

cod. 17187700

Tav 01



9

3

3

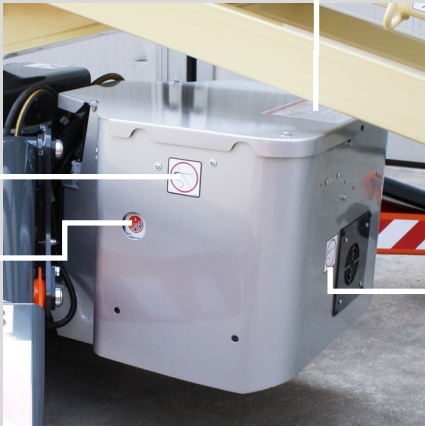

6

1

4



1

1

2

7

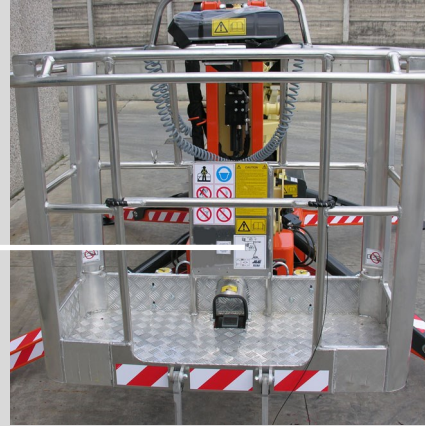

8



KIT ADESIVI X19J LITHIUM

SET OF DECALS X19J LITHIUM

KIT COLLANTS X19J LITHIUM

AUFKLEBERSATZ X19J LITHIUM

KIT ADHESIVOS X19J LITHIUM

ADHESIEKIT X19J LITHIUM

cod. 17187700

Tav 01

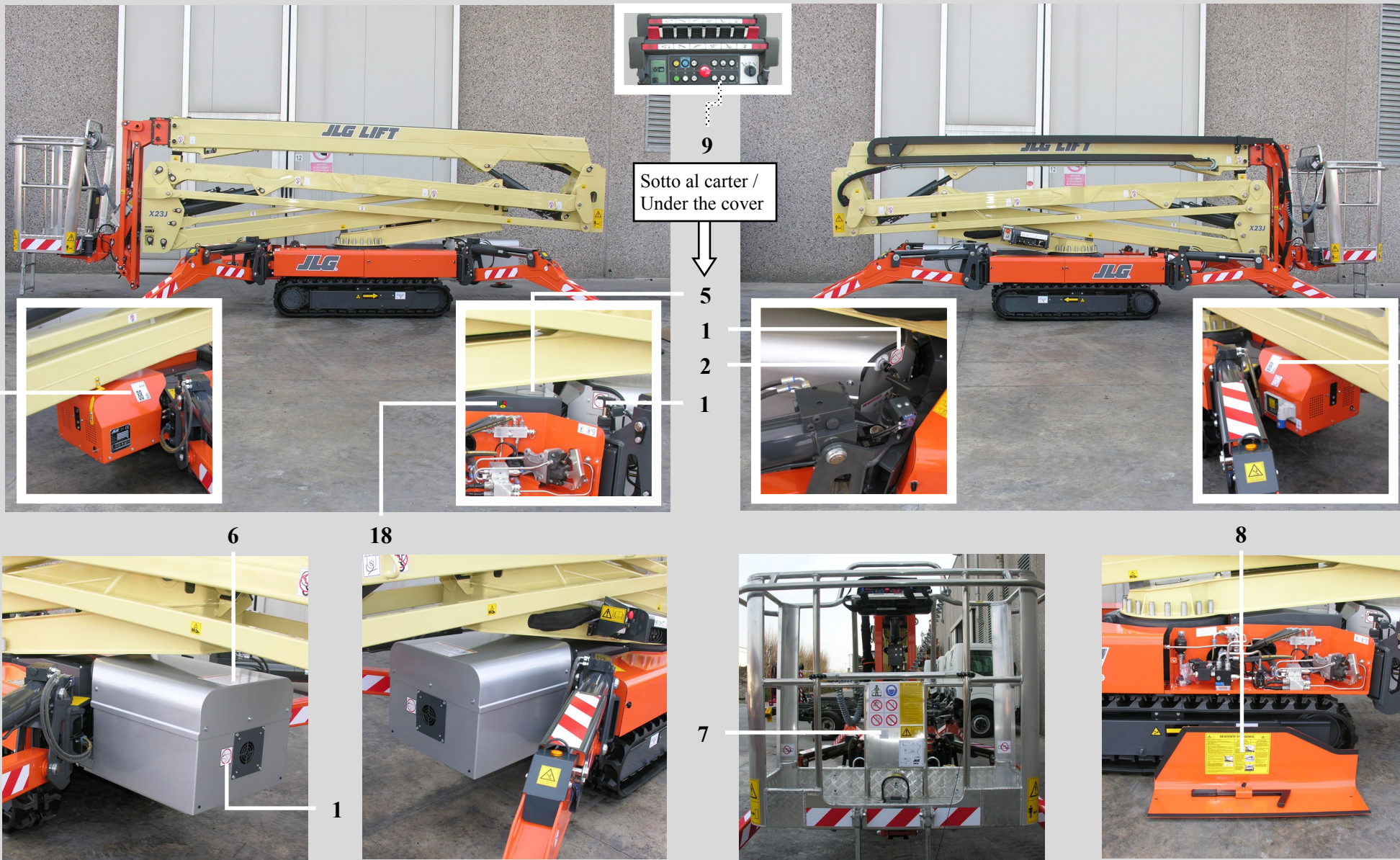

KIT ADESIVI X23J LITHIUM

SET OF DECALS X23J LITHIUM

KIT COLLANTS X23J LITHIUM

AUFKLEBERSATZ X23J LITHIUM

KIT ADHESIVOS X23J LITHIUM

ADHESIEKIT X23J LITHIUM

cod. 17187700

Tav 01



9



3

3



4

1



1

6

7

1



8

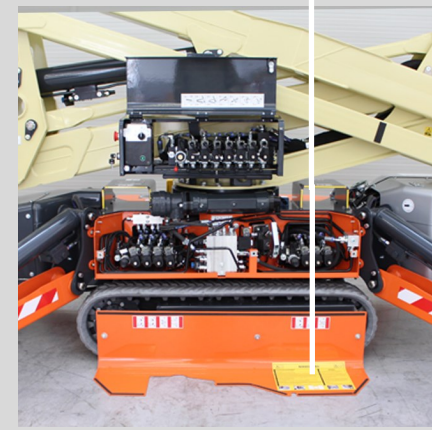

KIT ADESIVI - X13JPLUS LITHIUM
 SET OF DECALS - X13JPLUS LITHIUM
 KIT COLLANTS - X13JPLUS LITHIUM

AUFKLEBERSATZ X - X13JPLUS LITHIUM
 KIT ADHESIVOS - X13JPLUS LITHIUM
 ADHESIEKIT - X13JPLUS LITHIUM

cod. 17187700

Tav 01



9



3

3



4

1



1

6

1



7

1

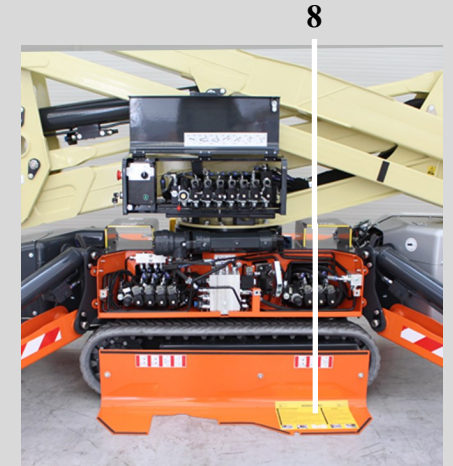

8

KIT ADESIVI - X15JPLUS LITHIUM

SET OF DECALS - X15JPLUS LITHIUM

KIT COLLANTS - X15JPLUS LITHIUM

AUFKLEBERSATZ X - X15JPLUS LITHIUM

KIT ADHESIVOS - X15JPLUS LITHIUM

ADHESIEKIT - X15JPLUS LITHIUM

cod. 17187700

Tav 01



9

3

3

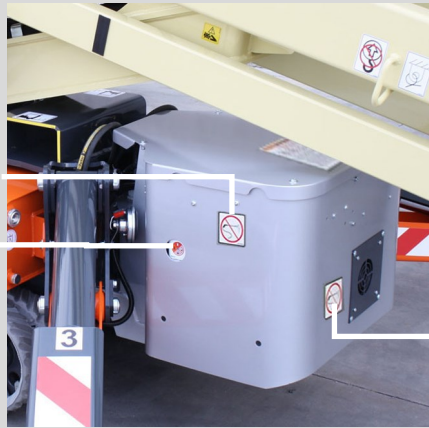

1

4

3



1

6

7

1



8



KIT ADESIVI X17JPLUS LITHIUM

SET OF DECALS X17JPLUS LITHIUM

KIT COLLANTS X17JPLUS LITHIUM

AUFKLEBERSATZ X17JPLUS LITHIUM

KIT ADHESIVOS X17JPLUS LITHIUM

ADHESIEKIT X17JPLUS LITHIUM

cod. 17187700

Tav 01



9

6



1

5

1



2

1

7



1

7

8



KIT ADESIVI X20JPLUS LITHIUM

SET OF DECALS X20JPLUS LITHIUM

KIT COLLANTS X20JPLUS LITHIUM

AUFKLEBERSATZ X20JPLUS LITHIUM

KIT ADHESIVOS X20JPLUS LITHIUM

ADHESIEKIT X20JPLUS LITHIUM

cod. 17187700

Tav 01

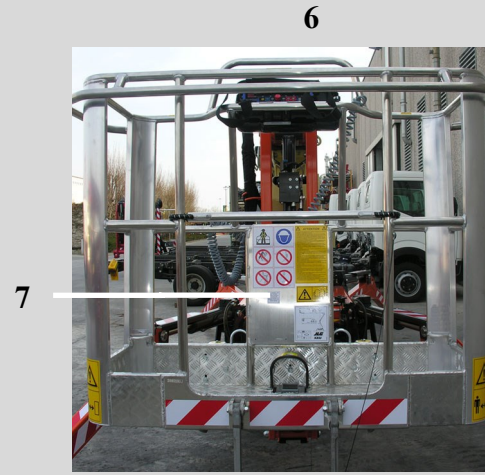
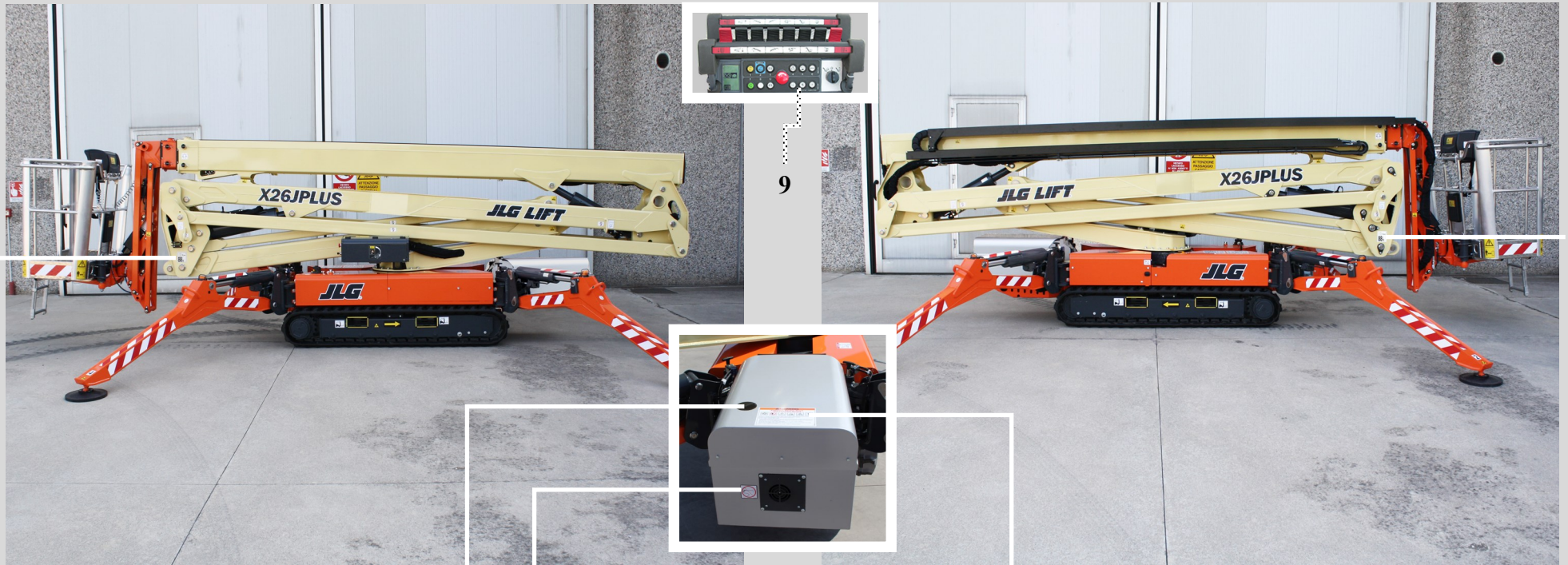

KIT ADESIVI X26JPLUS LITHIUM

SET OF DECALS X26JPLUS LITHIUM

KIT COLLANTS X26JPLUS LITHIUM

AUFKLEBERSATZ X26JPLUS LITHIUM

KIT ADHESIVOS X26JPLUS LITHIUM

ADHESIEKIT X26JPLUS LITHIUM

cod. 17187700

Tav 01

KIT LITHIUM SERIE JLG/CE COD. 171877 POSIZIONE ADESIVI IN LINGUA / POSITION LANGUAGE STICKERS**

POS.	COD.	REV.	DESCRIZIONE / DESCRIPTION	Q.tà
	171877IT		KIT ADESIVI INTEGRAZIONE PIATTAFORME AEREE JLG/CE LITHIUM - LINGUA ITALIANO	
06	07188700	A	ADESIVO JLG ATTENZIONE PERICOLO BATTERIE - ITA L=210X145 MM	01
07	07188100	A	ADESIVO JLG RICARICARE LE BATTERIE DOPO L'USO O ALMENO OGNI 3 MESI L=50x50 MM – ITA	01
08 solo X17J	1705720001	A	ADESIVO ISTRUZIONI DISCESA DI EMERGENZA GL14703S LITHIUM ITALIANO L=290X175 MM (**)	01
08			Per le / for X14J-X19J-X23J • X13JP-X15JP-X17JP-X20JP-X26JP Vedere discesa di emergenza motore termico / See emergency lowering heat engine	
	171877GB		KIT ADESIVI INTEGRAZIONE PIATTAFORME AEREE JLG/CE LITHIUM - LINGUA INGLESE	
06	07201700	A	ADESIVO JLG ATTENZIONE PERICOLO BATTERIE - ING L=210X145 MM	01
07	07202100	A	ADESIVO JLG-CE RICARICARE LE BATTERIE DOPO L'USO ALMENO OGNI 3 MESI - ING L=50x50 MM	01
08 per X17J	1705720002	A	ADESIVO ISTRUZIONI DISCESA DI EMERGENZA GL14703S LITHIUM INGLESE L=290X175 MM	01
08			Per le / for X14J-X19J-X23J • X13JP-X15JP-X17JP-X20JP-X26JP Vedere discesa di emergenza motore termico / See emergency lowering heat engine	
	171877FR		KIT ADESIVI INTEGRAZIONE PIATTAFORME AEREE JLG/CE LITHIUM - LINGUA FRANCESE	
06	07201800	A	ADESIVO JLG ADESIVO ATTENZIONE PERICOLO BATTERIE - FRA L=210X145 MM	01
07	07202200	A	ADESIVO JLG RICARICARE LE BATTERIE DOPO L'USO ALMENO OGNI 3 MESI - FRA L=50x50 MM	01
08 per X17J	1705720003	A	ADESIVO ISTRUZIONI DISCESA DI EMERGENZA GL14703S LITHIUM FRANCESE L=290X175 MM (**)	01
08			Per le / for X14J-X19J-X23J • X13JP-X15JP-X17JP-X20JP-X26JP Vedere discesa di emergenza motore termico / See emergency lowering heat engine	

KIT LITHIUM SERIE JLG/CE COD. 171877 POSIZIONE ADESIVI IN LINGUA / POSITION LANGUAGE STICKERS**

POS.	COD.	REV.	DESCRIZIONE / DESCRIPTION	Q.tà
	171877DE		KIT ADESIVI INTEGRAZIONE PIATTAFORME AEREE JLG/CE LITHIUM - LINGUA TEDESCO	
06	07188800	A	ADESIVO JLG ATTENZIONE PERICOLO BATTERIE - TED L=210X145 MM	01
07	07188200	A	ADESIVO JLG RICARICARE LE BATTERIE DOPO L'USO O ALMENO OGNI 3 MESI L=50x50 MM –TED	01
08 per X17J	1705720004	A	ADESIVO ISTRUZIONI DISCESA DI EMERGENZA GL14703S LITHIUM TEDESCO L=290X175 MM (**)	01
08	Per le / for X14J-X19J-X23J • X13JP-X15JP-X17JP-X20JP-X26JP Vedere discesa di emergenza motore termico / See emergency lowering heat engine			
	171877ES		KIT ADESIVI INTEGRAZIONE PIATTAFORME AEREE JLG/CE LITHIUM - LINGUA SPAGNOLO	
06	07201900	A	ADESIVO JLG ATTENZIONE PERICOLO BATTERIE - SPA L=210X145 MM -	01
07	07202300	A	ADESIVO JLG RICARICARE LE BATTERIE DOPO L'USO ALMENO OGNI 3 MESI - SPA L=50x50 MM	01
08 per X17J	1705720005	A	ADESIVO ISTRUZIONI DISCESA DI EMERGENZA GL14703S LITHIUM SPAGNOLO L=290X175 MM (**)	01
08	Per le / for X14J-X19J-X23J • X13JP-X15JP-X17JP-X20JP-X26JP Vedere discesa di emergenza motore termico / See emergency lowering heat engine			
	171877NL		KIT ADESIVI INTEGRAZIONE PIATTAFORME AEREE JLG/CE LITHIUM - LINGUA OLANDESE	
06	07188900	A	ADESIVO JLG ATTENZIONE PERICOLO BATTERIE - OLA L=210X145 MM	01
07	07188300	A	ADESIVO JLG RICARICARE LE BATTERIE DOPO L'USO O ALMENO OGNI 3 MESI L=50x50 MM – OLA	01
08 per X17J	1705720006	A	ADESIVO ISTRUZIONI DISCESA DI EMERGENZA GL14703S LITHIUM OLANDESE L=290X175 MM (**)	01
08	Per le / for X14J-X19J-X23J • X13JP-X15JP-X17JP-X20JP-X26JP Vedere discesa di emergenza motore termico / See emergency lowering heat engine			

KIT LITHIUM SERIE JLG/CE COD. 171877 POSIZIONE ADESIVI IN LINGUA / POSITION LANGUAGE STICKERS**

POS.	COD.	REV.	DESCRIZIONE / DESCRIPTION	Q.tà
	171877SW		KIT ADESIVI INTEGRAZIONE PIATTAFORME AEREE JLG/CE LITHIUM - LINGUA SVEDESE	
06	07189000	A	ADESIVO JLG ATTENZIONE PERICOLO BATTERIE - SVE L=210X145 MM	01
07	07188400	A	ADESIVO JLG RICARICARE LE BATTERIE DOPO L'USO O ALMENO OGNI 3 MESI L=50x50 MM – SVE	01
08 per X17J	1705720010	A	ADESIVO ISTRUZ. DISCESA DI EMERGENZA GL14703S LITHIUM SVEDESE L=290X175 MM (**)	01
08	Per le / for X14J-X19J-X23J • X13JP-X15JP-X17JP-X20JP-X26JP			
	Vedere discesa di emergenza motore termico / See emergency lowering heat engine			
	171877PT		KIT ADESIVI INTEGRAZIONE PIATTAFORME AEREE JLG/CE LITHIUM - LINGUA PORTOGHESE	
06	07202000	A	ADESIVO JLG ATTENZIONE PERICOLO BATTERIE - POR L=210X145 MM	01
07	07202400	A	ADESIVO JLG RICARICARE LE BATTERIE DOPO L'USO O ALMENO OGNI 3 MESI L=50x50 MM – POR	01
08 per X17J	1705720007	A	ADESIVO ISTRUZ. DISCESA DI EMERGENZA GL14703S LITHIUM PORTOGHESE L=290X175 MM (**)	01
08	Per le / for X14J-X19J-X23J • X13JP-X15JP-X17JP-X20JP-X26JP			
	Vedere discesa di emergenza motore termico / See emergency lowering heat engine			
	171877DA		KIT ADESIVI INTEGRAZIONE PIATTAFORME AEREE JLG/CE LITHIUM - LINGUA DANESE	
06	07189100	A	ADESIVO JLG ATTENZIONE PERICOLO BATTERIE - DAN L=210X145 MM	01
07	07188500	A	ADESIVO JLG RICARICARE LE BATTERIE DOPO L'USO O ALMENO OGNI 3 MESI L=50x50 MM – DAN	01
08 per X17J	1705720011	A	ADESIVO ISTRUZ. DISCESA DI EMERGENZA GL14703S LITHIUM DANESE L=290X175 MM (**)	01
08	Per le / for X14J-X19J-X23J • X13JP-X15JP-X17JP-X20JP-X26JP			
	Vedere discesa di emergenza motore termico / See emergency lowering heat engine			

KIT LITHIUM SERIE JLG/CE COD. 171877 POSIZIONE ADESIVI IN LINGUA / POSITION LANGUAGE STICKERS**

POS.	COD.	REV.	DESCRIZIONE / DESCRIPTION	Q.tà
	171877NO		KIT ADESIVI INTEGRAZIONE PIATTAFORME AEREE JLG/CE LITHIUM - LINGUA NORVEGESE	
06	07189200	A	ADESIVO JLG ATTENZIONE PERICOLO BATTERIE - NOR L=210X145 MM	01
07	07188600	A	ADESIVO JLG RICARICARE LE BATTERIE DOPO L'USO O ALMENO OGNI 3 MESI L=50x50 MM – NOR	01
08 per X17J	1705720012	A	ADESIVO ISTRUZ. DISCESA DI EMERGENZA GL14703S LITHIUM NORVEGESE L=290X175 MM (**)	01
08	Per le / for X14J - X17JPLUS - X19J - X20JPLUS - X23J - X26JPLUS Vedere discesa di emergenza motore termico / See emergency lowering heat engine			
	171877RU		KIT ADESIVI INTEGRAZIONE PIATTAFORME AEREE JLG/CE LITHIUM - LINGUA RUSSO	
06	07920800	A	ADESIVO JLG ATTENZIONE PERICOLO BATTERIE - RUSSO L=210X145 MM	01
07	07910300	A	ADESIVO JLG RICARICARE LE BATTERIE DOPO L'USO O ALMENO OGNI 3 MESI L=50x50 MM – RUS	01
08 per X17J	/		/	/
08	Per le / for X14J - X17JPLUS - X19J - X20JPLUS - X23J - X26JPLUS Vedere discesa di emergenza motore termico / See emergency lowering heat engine			
	171877PL		KIT ADESIVI INTEGRAZIONE PIATTAFORME AEREE JLG/CE LITHIUM - LINGUA POLACCO	
06	07508000	A	ADESIVO JLG-ANSI ATTENZIONE PERICOLO BATTERIE - POLACCO L=210X145 MM	01
07	07508100	A	ADESIVO JLG-CE RICARICARE LE BATTERIE DOPO L'USO - POLACCO L=50x50 MM	01
08 per X17J	/		/	/
08	Per le / for X14J - X17JPLUS - X19J - X20JPLUS - X23J - X26JPLUS Vedere discesa di emergenza motore termico / See emergency lowering heat engine			

KIT LITHIUM SERIE JLG/CE COD. 171877 POSIZIONE ADESIVI IN LINGUA / POSITION LANGUAGE STICKERS**

POS.	COD.	REV.	DESCRIZIONE / DESCRIPTION	Q.tà
	171877SL		KIT ADESIVI INTEGRAZIONE PIATTAFORME AEREE JLG/CE LITHIUM - LINGUA SLOVENO	
06	07920900	A	ADESIVO JLG / CE ATTENZIONE PERICOLO BATTERIE - SLOVENO L=210X145 MM	01
07	07910500	A	ADESIVO JLG RICARICARE LE BATTERIE DOPO L'USO O ALMENO OGNI 3 MESI L=50x50 MM – SLO	01
08 per X17J	/	/	/	/
08	Per le / for X14J - X17JPLUS - X19J - X20JPLUS - X23J - X26JPLUS Vedere discesa di emergenza motore termico / See emergency lowering heat engine			
	171877FI		KIT ADESIVI INTEGRAZIONE PIATTAFORME AEREE JLG/CE LITHIUM - LINGUA FINLANDESE	
06	07921000	A	ADESIVO JLG / CE ATTENZIONE PERICOLO BATTERIE - FINLANDESE L=210X145 MM	01
07	07910600	A	ADESIVO JLG RICAR. LE BATTERIE DOPO L'USO O ALMENO OGNI 3 MESI L=50x50 MM – FINLANDE	01
08 per X17J	/	/	/	/
08	Per le / for X14J - X17JPLUS - X19J - X20JPLUS - X23J - X26JPLUS Vedere discesa di emergenza motore termico / See emergency lowering heat engine			
	171877CE		KIT ADESIVI INTEGRAZIONE PIATTAFORME AEREE JLG/CE LITHIUM - LINGUA CECO	
06	07921100	A	ADESIVO JLG-CE ATTENZIONE PERICOLO BATTERIE - CECO L=210X145 MM	01
07	07910700	A	ADESIVO JLG-CE RICARICARE LE BATTERIE DOPO L'USO ALMENO OGNI 3 MESI - JAPAN L=50x50 MM	01
08 per X17J	/		/	/
08	Per le / for X14J - X17JPLUS - X19J - X20JPLUS - X23J - X26JPLUS Vedere discesa di emergenza motore termico / See emergency lowering heat engine			
	171877JA		KIT ADESIVI INTEGRAZIONE PIATTAFORME AEREE JLG/CE LITHIUM - LINGUA GIAPPONESE	
06	07341100	A	ADESIVO JLG - CE ATTENZIONE PERICOLO BATTERIE - JAPAN L=210X145 MM	01
07	07341200	A	ADESIVO JLG-CE RICARICARE LE BATTERIE DOPO L'USO - JAPAN L=50x50 MM	01
08 per X17J	/		/	/
08	Per le / for X14J - X17JPLUS - X19J - X20JPLUS - X23J - X26JPLUS Vedere discesa di emergenza motore termico / See emergency lowering heat engine			

**KIT ADESIVI SICUREZZA PER PIATTAFORMA AEREA /
*STICKERS KIT SECURITY FOR AERIAL PLATFORM***

JLG/CE - X15JPLUS / X13JPLUS

Cod. 17788100

+ kit in lingua non incluso nel codice generale / *kit in the language not included in the general code*

**177881IT / 177881GB / 177881FR / 177881DE / 177881ES / 177881NL / 177881SW /
177881PT / 177881DA / 177881NO / 177881RU / 177881PL / 177881SL / 177881FI
177881CE / 177881JA**

DA USARE CON / FOR USE WITH

**COD. 17788200 KIT ADESIVI COMMERCIALI PER PIATTAFORMA AEREA / *STICKER KITS COMMERCIAL AERIAL PLATFORM*
JLG/CE X15JPLUS**

DA USARE CON / FOR USE WITH

**COD. 17788400 KIT ADESIVI COMMERCIALI PER PIATTAFORMA AEREA / *STICKER KITS COMMERCIAL AERIAL PLATFORM*
JLG/CE X13JPLUS**

**COD. 17187700 KIT INTEGRAZIONE ADESIVI PER PIATTAFORME AEREE JLG/CE LITHIUM /
*INTEGRATION KIT STICKERS PLATFORMS JLG / CE LITHIUM STICKER KIT INTEGRATION PLATFORM LITHIUM***

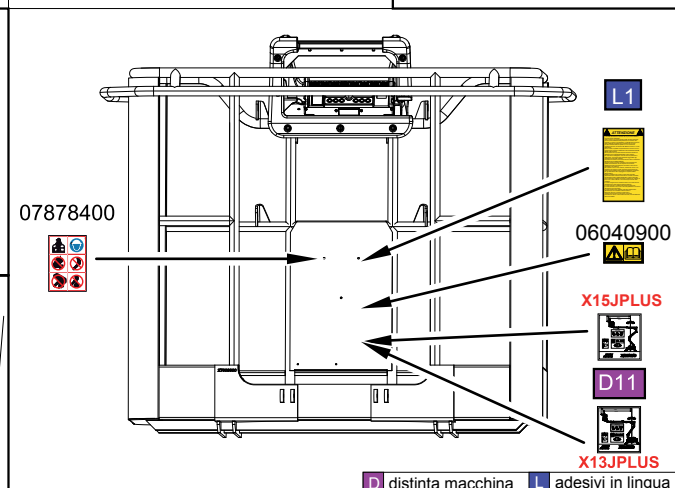
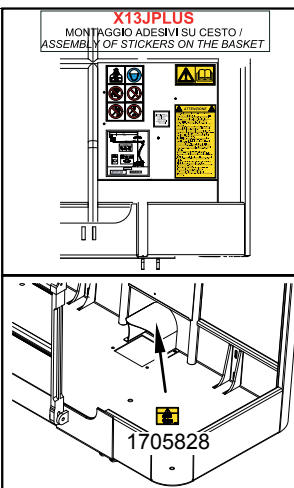
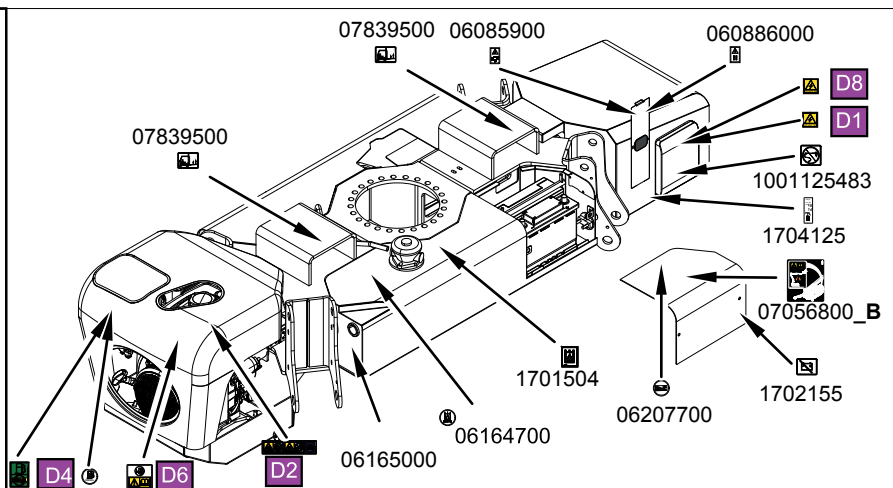
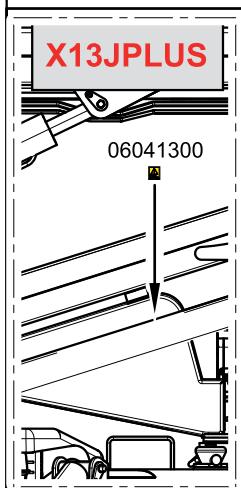
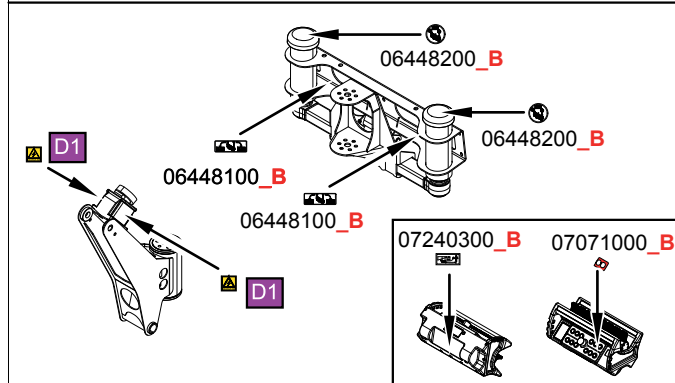
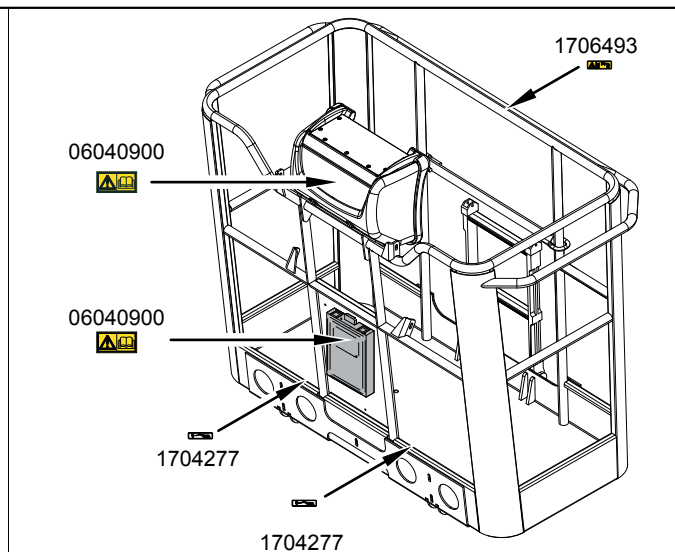
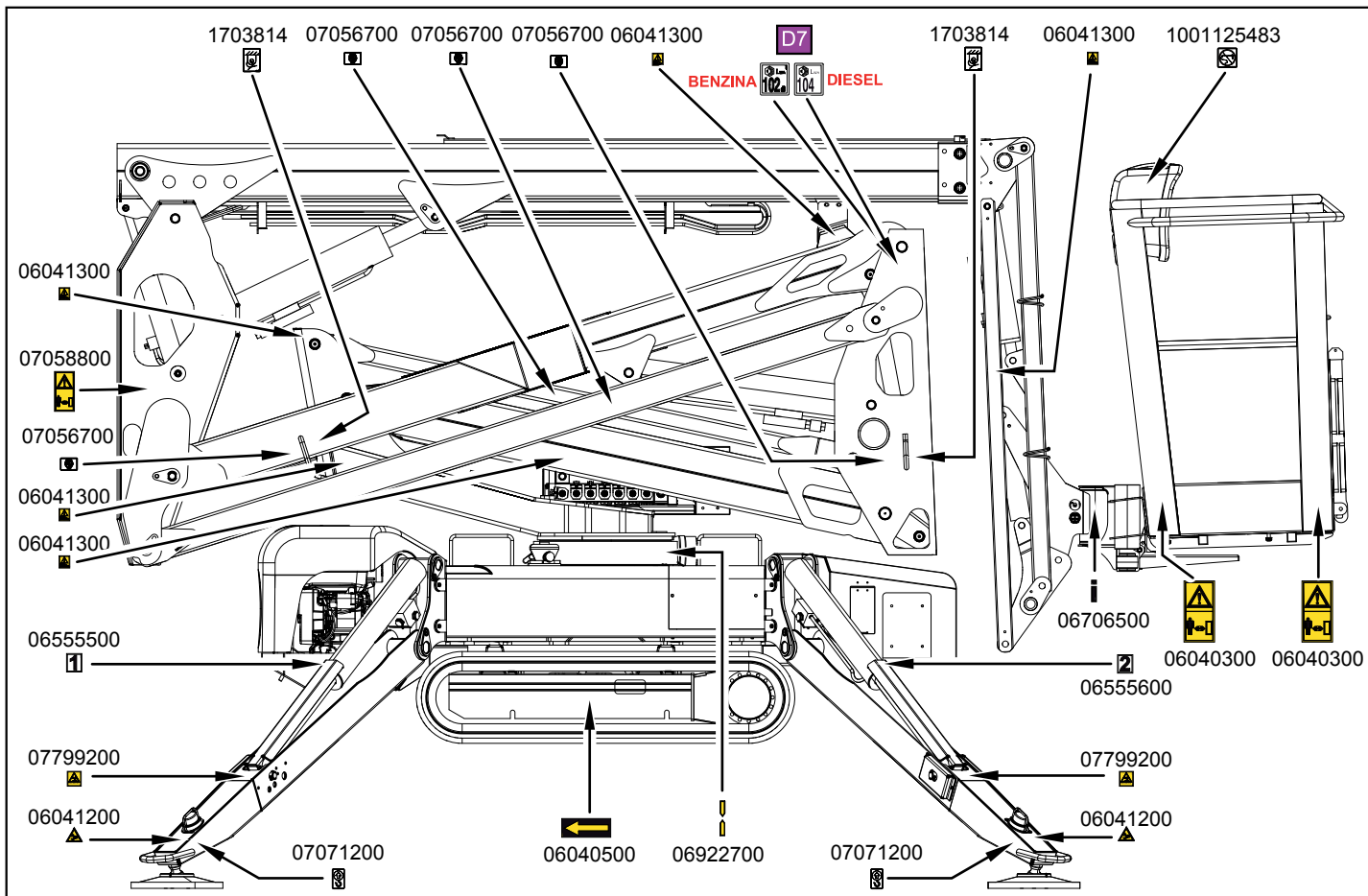

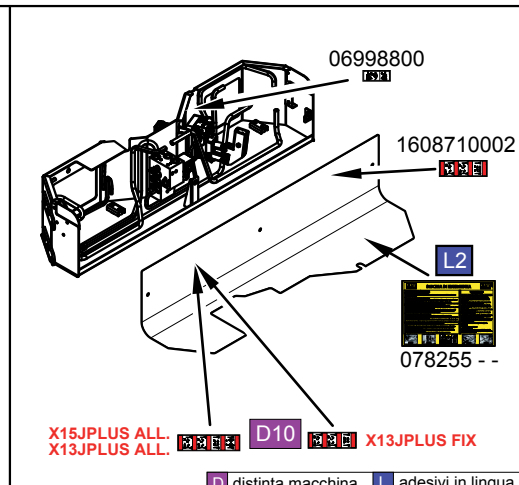
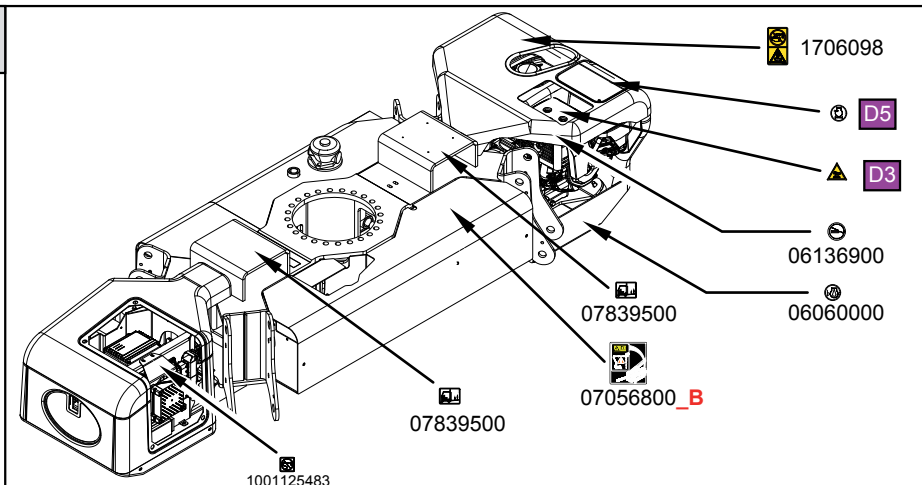
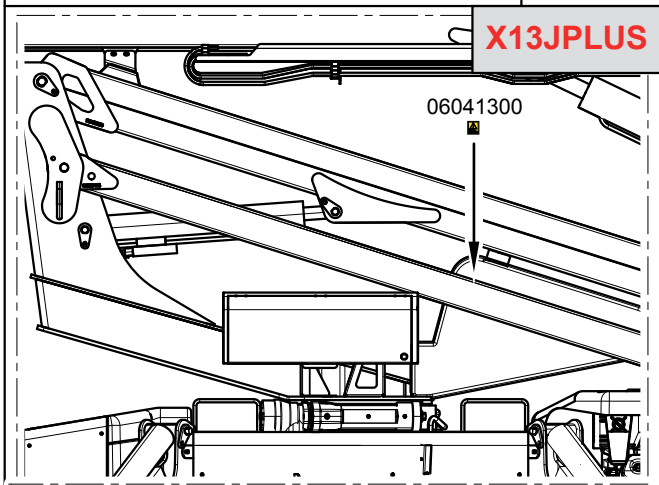
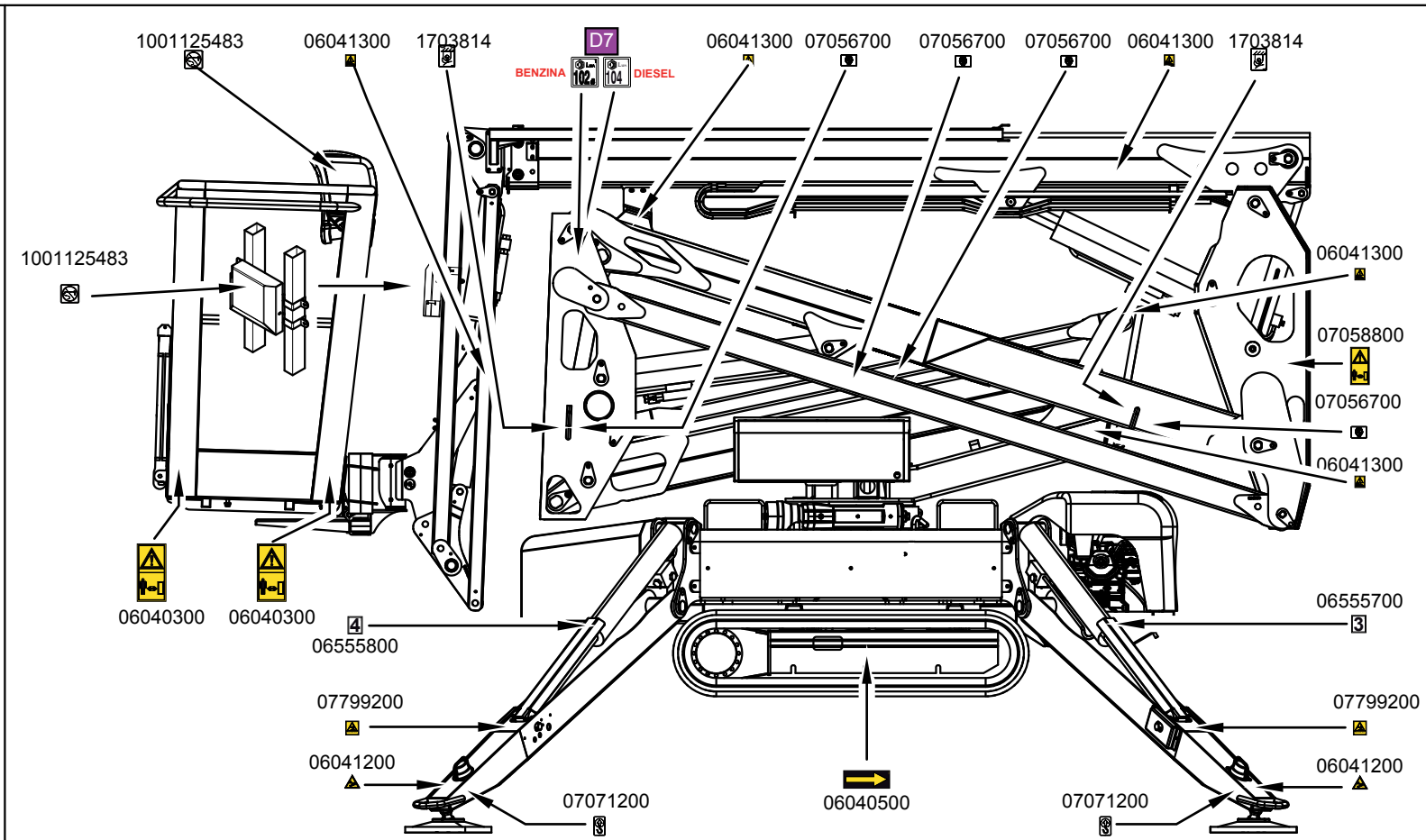
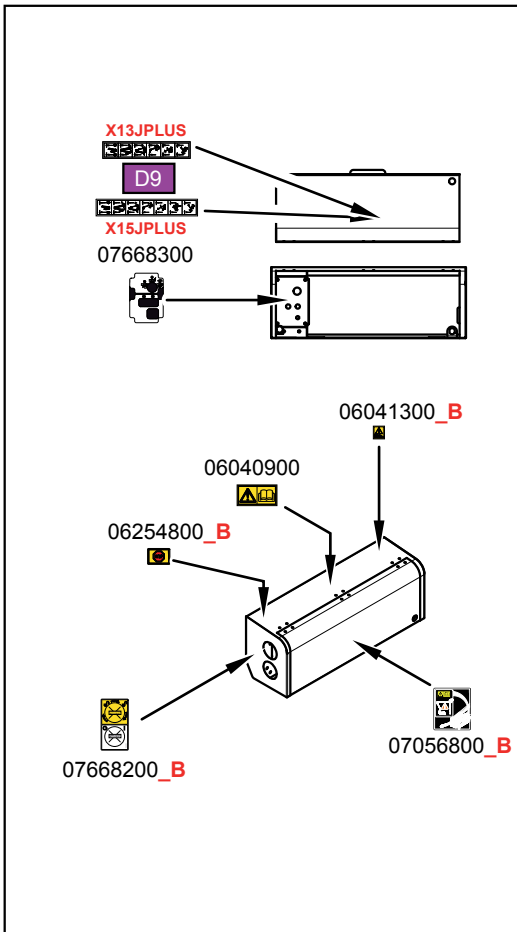

COD. 17788100 ADESIVI IN DISTINTA MACCHINA / STICKERS IN THE MACHINE LIST

VOLT

Num.	COD.	DESCRIZIONE / DESCRIPTION	Q.tà
D1	06042400	ADESIVO PERICOLO 110 VOLT 16A GIALLO _MOD_B	3
D1	06257300	ADESIVO PERICOLO 240 VOLT GIALLO L=47 X 47 MM	3
D1	06561200	ADESIVO PERICOLO 230 VOLT 16 AMPERE GIALLO L=47X47 MM _MOD_B	3
D2	06232100	ADESIVO ATTENZIONE BENZINA INFIAMMABILE L=170X42 MM _MOD_B	1
D3	06056300	ADESIVO PERICOLO SCOTTATURE TRIANGOLARE SFONDO GIALLO	1
D4	06041600	ADESIVO CARBURANTE BENZINA COLORE VERDE L=60 X 80 MM _MOD_B	1
D4	06043900	ADESIVO CARBURANTE DIESEL SFONDO BIANCO Ø 50 MM	1
D5	06164600	ADESIVO FILTRO ARIA SFONDO BIANCO Ø50 MM	1
D6	06227200	ADESIVO CONTROLLARE LIVELLO OLIO MOTORE L=80X80 MM _MOD_B	1
D7	07802200	ADESIVO RUMORE 102 dB L=90X100 MM (MOTORE BENZINA)	2
	07034200	ADESIVO RUMORE 104 dB L=90X100 MM (MOTORE DIESEL _MOD_B	
D8	07668000	ADESIVO PERICOLO 110 VOLT 32A GIALLO L=47 X 47 MM	1
D9	07668100	ADESIVO PULSANTI DISTRIBUTORE PARTE AEREA LL2614 L=318X52 MM - (PER 1570)	1
	07864500	ADESIVO PULSANTI DISTRIBUTORE PARTE AEREA LL13.70 L=274X52 MM - (PER 1370)	1
D10	1608710001	ADESIVO PULSANTI DISTRIBUTORE A TERRA LATO SX GL17.80 L= 194X50 MM _MOD_C - (PER 1570)	1
	07864600	ADESIVO PULSANTI DISTRIBUTORE A TERRA LATO SX LL13.70 L= 150X50 MM - (PER 1370)	1
D11	07799400	ADESIVO PORTATA CESTO 2 PERSONE X15JPLUS L=135X145 MM	1
	07868200	ADESIVO PORTATA CESTO 2 PERSONE X13JPLUS L=135X145 MM	1
			1

COD. 17788100 ELENCO ADESIVI / LIST STICKERS

---	COD.	DESCRIZIONE / DESCRIPTION	Q.tà
	06040300	ADESIVO PERICOLO MANTENERE LE DISTANZE GIALLO L=100 X 200 MM	4
	06040500	ADESIVO DIREZ. TRASLAZIONE FRECCIA GIALLA SFONDO NERO L=61 X 160 MM	2
	06040900	ADESIVO LEGGERE IL MANUALE GIALLO L=125 X 65 MM	5
	06041200	ADESIVO SCHIACCIAMENTO PIEDI TRIANGOLARE L=53X46 MM	4
	06041300	ADESIVO ATTENZIONE PERICOLO TAGLI L=35 X 40 MM GIALLO_ MOD_B	13
	06060000	ADESIVO LIVELLO OLIO MOTORE Ø50 MM	1
	06085900	ADESIVO SISTEMA BYPASS PARTE AEREA L=30X50 MM	1
	06086000	ADESIVO SISTEMA BYPASS TRASLAZIONE L=30X50 MM (**)	1
	06136900	ADESIVO PUNTI INGRASSAGGIO Ø 55 TESTO NERO - SFONDO BIANCO	1
	06164700	ADESIVO FILTRO OLIO IDRAULICO BIANCO Ø50 MM	1
	06165000	ADESIVO LIVELLO OLIO IDRAULICO SFONDO BIANCO Ø50 MM	1
	06207700	ADESIVO BATTERIA POLO POSITIVO POLO NEGATIVO BIANCO Ø50 (**)	1
	06254800	ADESIVO STOP EMERGENZA SFONDO GIALLO L=70X50 MM_ MOD_B	1
	06448100	ADESIVO RIPRISTINARE I TAPPI FERMO GUIDA L= 100X35 MM_ MOD_B	2
	06448200	ADESIVO "SBLOCCARE SOLO NEI CASI PREVISTI" Ø 60 MM_ MOD_B	2
	06555500	ADESIVO NR 1 BIANCO L=50X60 MM	1
	06555600	ADESIVO NR 2 BIANCO L=50X60 MM	1
	06555700	ADESIVO NR 3 BIANCO L=50X60 MM	1
	06555800	ADESIVO NR 4 BIANCO L=50X60 MM	1
	06706500	ADESIVO ALLINEAMENTO CESTO (2 PEZZI) L=16X50+13(**)	1
	06922700	ADESIVO FRECCIA ALLINEAMENTO L=50x15 (**)	2
	06998800	ADESIVO DEVIATORE POMPA MANUALE PIATTAFORMA GL17. 80XL L=86X34 MM	1
	07056700	ADESIVO JLG DIVIETO DI SOLLEVAMENTO L=54,88X40	8
	07056800	ADESIVO JLG DISCESA DI EMERGENZA ALL'INTERNO L=114X130 MM_ MOD_B	3

COD. 17788100 ELENCO ADESIVI / LIST STICKERS

---	COD.	DESCRIZIONE / DESCRIPTION	Q.tà
	07058800	ADESIVO PERICOLO MANTENERE LE DISTANZE L=65X130 MM - GIALLO	2
	07071000	ADESIVO JLG CLAXON SU PIATTAFORME L=39,3X28,55 MM_ MOD_B	1
	07071200	ADESIVO JLG PUNTO DI SOLLEVAMENTO L= 40X66 MM	8
	07240300	ADESIVO DISTANZA 1 METRO SU TELE/RADIO COMANDI L= 75x35 MM_ MOD_B	1
	07668200	ADESIVO EMERGENCY STOP E BLOCCHETTO ACCENSIONE L= 85x160 MM_ MOD_B	1
	07668300	ADESIVO SELETTORE SCATOLA COMANDI TERRA / CESTO L= 105X155 MM	1
	07799200	ADESIVO REAZIONE AL SUOLO STABILIZZATORI LL1570 1670 daN L=45x48 MM	4
	07839500	ADESIVO SOLLEVAMENTO PIATTAFORMA CON MULETTO - PICCOLO L=65X50 MM	4
	07878400	ADESIVO CASCO IMBRAGATURA E DIVIETI LL1370 L=175X118 MM	1
	1001125483	ADESIVO JLG VIETATO LAVARE L=63,5X63,5 MM	7
	1608710002	ADESIVO PULSANTI DISTRIBUTORE A TERRA LATO DX GL17.80 L L=150X50 MM_ MOD_C	1
	1701504	ADESIVO JLG OLIO IDRAULICO L=50,8x63,5 MM (**)	1
	1702155	ADESIVO JLG STACCABATTERIA L= 63,5X50,80 MM	1
	1703814	ADESIVO JLG ATTACCO ANCORAGGIO L=55,56X76,2 MM	4
	1704125	ADESIVO JLG ATTACCO ARIA E OLIO L=25,4X76,2 MM	1
	1704277	ADESIVO JLG ATTACCO CINTURE DI SICUREZZA L= 76,2X19,05 MM	2
	1705828	ADESIVO JLG INTERUTTORE PEDALE L= 69,85X54 _ MOD_B	1
	1706098	ADESIVO JLG PERICOLO ESPLOSIONE L=63,5X117,475 MM_ MOD_B	1
	1706493	ADESIVO JLG SCORRIMENTO SBARRA CHIUSURA CESTO L= 76, 2X25,4 MM_ MOD_B	1
	07799500	ADESIVO JLG PORTATA CESTO 1 PERSONA X15JPLUS L=135X145 MM “ non in distinta “	1
	07868400	ADESIVO JLG PORTATA CESTO 1 PERSONA X13JPLUS L=135X145 MM “ non in distinta “	1

ELENCO ADESIVI IN LINGUA / LIST LANGUAGE STICKERS

Num.	COD.	DESCRIZIONE / DESCRIPTION	Q.tà
	177881IT	ADESIVI IN LINGUA PER JLG/CE X15JPLUS - LINGUA ITALIANO	
L1	06555300	ADESIVO USO PIATTAFORMA AEREA CINGOLATA - ITALIANO L=128X230 _MOD_C	01
L2	078255IT	ADESIVO DISCESA DI EMERG. LL15.70 MOTORE TERMICO E LITHIUM - ITALIANO L=290X205 MM	01
	177881GB	ADESIVI IN LINGUA PER JLG/CE X15JPLUS - LINGUA INGLESE	
L1	06562600	ADESIVO USO PIATTAFORMA AEREA CINGOLATA - INGLESE L=128X230 _MOD_C	01
L2	078255GB	ADESIVO DISCESA DI EMERG. LL15.70 MOTORE TERMICO E LITHIUM - INGLESE L=290X205 MM	01
	177881FR	ADESIVI IN LINGUA PER JLG/CE X15JPLUS - LINGUA FRANCESE	
L1	06562700	ADESIVO USO PIATTAFORMA AEREA CINGOLATA - FRANCESE L=128X230 _MOD_C	01
L2	078255FR	ADESIVO DISCESA DI EMERG. LL15.70 MOTORE TERMICO E LITHIUM - FRANCESE L=290X205 MM	01
	177881DE	ADESIVI IN LINGUA PER JLG/CE X15JPLUS - LINGUA TEDESCO	
L1	06562800	ADESIVO USO PIATTAFORMA AEREA CINGOLATA - TEDESCO L=128X230 _MOD_C	01
L2	078255DE	ADESIVO DISCESA DI EMERG.LL15.70 MOTORE TERMICO E LITHIUM - TEDESCO L=290X205 MM	01
	177881ES	ADESIVI IN LINGUA PER JLG/CE X15JPLUS - LINGUA SPAGNOLO	
L1	06562900	ADESIVO USO PIATTAFORMA AEREA CINGOLATA - SPAGNOLO L=128X230 _MOD_C	01
L2	078255ES	ADESIVO DISCESA DI EMERG. LL15.70 MOTORE TERMICO E LITHIUM - SPAGNOLO L=290X205 MM	01
	177881NL	ADESIVI IN LINGUA PER JLG/CE X15JPLUS - LINGUA OLANDESE	
L1	06563000	ADESIVO USO PIATTAFORMA AEREA CINGOLATA - OLANDESE L=128X230 _MOD_C	01
L2	078255NL	ADESIVO DISCESA DI EMERG. LL15.70 MOTORE TERMICO E LITHIUM - OLANDESE L=290X205 MM	01

ELENCO ADESIVI IN LINGUA / LIST LANGUAGE STICKERS

Num.	COD.	DESCRIZIONE / DESCRIPTION	Q.tà
	177881SW	ADESIVI IN LINGUA PER JLG/CE X15JPLUS - LINGUA SVEDESE	
L1	07137300	ADESIVO USO PIATTAFORMA AEREA CINGOLATA - SVEDESE L= 128X230 MM _MOD_C	01
L2	078255SW	ADESIVO DISCESA DI EMERG. LL15.70 MOTORE TERMICO E LITHIUM - SVEDESE L=290X205 MM	01
	177881PT	ADESIVI IN LINGUA PER JLG/CE X15JPLUS - LINGUA PORTOGHESE	
L1	06563100	ADESIVO USO PIATTAFORMA AEREA CINGOLATA - PORTOGHESE L=128X230 _MOD_C	01
L2	078255PT	ADESIVO DISCESA DI EMERG. LL15.70 MOTORE TERMICO E LITHIUM - PORTOGHESE L=290X205 MM	01
	177881DA	ADESIVI IN LINGUA PER JLG/CE X15JPLUS - LINGUA DANESE	
L1	07138100	ADESIVO USO PIATTAFORMA AEREA CINGOLATA - DANESE L= 128X230 MM _MOD_C	01
L2	078255DA	ADESIVO DISCESA DI EMERG. LL15.70 MOTORE TERMICO E LITHIUM - DANESE L=290X205 MM	01
	177881NO	ADESIVI IN LINGUA PER JLG/CE X15JPLUS - LINGUA NORVEGESE	
L1	07162000	ADESIVO USO PIATTAFORMA AEREA CINGOLATA - NORVEGESE L=128X230 MM _MOD_C	01
L2	078255NO	ADESIVO DISCESA DI EMERG. LL15.70 MOTORE TERMICO E LITHIUM - NORVEGESE L=290X205 MM	01
	177881RU	ADESIVI IN LINGUA PER JLG/CE X15JPLUS - LINGUA RUSSO	
L1	07514800	ADESIVO USO PIATTAFORMA AEREA CINGOLATA - RUSSO L=128X230 MM	01
L2	078255RU	ADESIVO DISCESA DI EMERG. LL15.70 MOTORE TERMICO E LITHIUM - RUSSO L=290X205 MM	01
	177881PL	ADESIVI IN LINGUA PER JLG/CE X15JPLUS - LINGUA POLACCO	
L1	07506600	ADESIVO USO PIATTAFORMA AEREA CINGOLATA - POLACCO L= 128X230 MM _MOD_B**	01
L2	078255PL	ADESIVO DISCESA DI EMERG. LL15.70 MOTORE TERMICO E LITHIUM - POLACCO L=290X205 MM	01

F gwci riq'f kuvpvc

distinta 17788100	Descrizione KIT ADESIVI DI SICUREZZA PER PIATTAFORMA AEREA JLG/CE - X			quantità componenti percentuale <input type="checkbox"/>	Disegno
Tipo Articolo	Data creazione 06/04/2016	Data ultimo aggiorn 03/10/2017	Unità di misura NR	Nota	

Tipo	Componente	Descrizione	N.F.	Da Espl.	Quantità	Qtà perc.	Un. mis.	Quantità sfridi	Un. mis.	Nota
Articolo	06040300	ADESIVO PERICOLO MANTENERE LE DISTANZE GIALLO L=100 X 200 MM		Si	4,00	0,00	NR	0,00	NR	
Articolo	06040500	ADESIVO DIREZIONE TRASLAZIONE FRECCIA GIALLA SFONDO NERO L=61 X 160 MM		Si	2,00	0,00	NR	0,00	NR	
Articolo	06040900	ADESIVO LEGGERE IL MANUALE GIALLO L=125 X 65 MM		Si	5,00	0,00	NR	0,00	NR	
Articolo	06041200	ADESIVO SCHIACCIAMENTO PIEDI TRIANGOLARE L=53X46 MM		Si	4,00	0,00	NR	0,00	NR	
Articolo	06041300	ADESIVO ATTENZIONE PERICOLO TAGLI L=35 X 40 MM GIALLO_ MOD_B		Si	13,00	0,00	NR	0,00	NR	
Articolo	06060000	ADESIVO LIVELLO OLIO MOTORE Ø50 MM		Si	1,00	0,00	NR	0,00	NR	
Articolo	06085900	ADESIVO SISTEMA BYPASS PARTE AEREA L=30X50 MM		Si	1,00	0,00	NR	0,00	NR	
Articolo	06086000	ADESIVO SISTEMA BYPASS TRASLAZIONE L=30X50 MM (**)		Si	1,00	0,00	NR	0,00	NR	
Articolo	06136900	ADESIVO PUNTI INGRASSAGGIO Ø 55 MM		Si	1,00	0,00	NR	0,00	NR	
Articolo	06164700	ADESIVO FILTRO OLIO IDRAULICO BIANCO Ø50 MM		Si	1,00	0,00	NR	0,00	NR	
Articolo	06165000	ADESIVO LIVELLO OLIO IDRAULICO SFONDO BIANCO Ø50 MM		Si	1,00	0,00	NR	0,00	NR	
Articolo	06207700	ADESIVO BATTERIA POLO POSITIVO POLO NEGATIVO BIANCO Ø50 MM (**)		Si	1,00	0,00	NR	0,00	NR	
Articolo	06254800	ADESIVO STOP EMERGENZA SFONDO GIALLO L=70X50 MM_MOD_ B		Si	1,00	0,00	NR	0,00	NR	
Articolo	06448100	ADESIVO RIPRISTINARE I TAPPI FERMO GUIDA L= 100X35 MM_ MOD_B		Si	2,00	0,00	NR	0,00	NR	
Articolo	06448200	ADESIVO "SBLOCCARE SOLO NEI CASI PREVISTI" Ø 60 MM_MOD_B		Si	2,00	0,00	NR	0,00	NR	
Articolo	06555500	ADESIVO NR 1 BIANCO L=50X60 MM		Si	1,00	0,00	NR	0,00	NR	
Articolo	06555600	ADESIVO NR 2 BIANCO L=50X60 MM		Si	1,00	0,00	NR	0,00	NR	
Articolo	06555700	ADESIVO NR 3 BIANCO L=50X60 MM		Si	1,00	0,00	NR	0,00	NR	
Articolo	06555800	ADESIVO NR 4 BIANCO L=50X60 MM		Si	1,00	0,00	NR	0,00	NR	
Articolo	06706500	ADESIVO ALLINEAMENTO CESTO (2 PEZZI) L=16X50+13(**)		Si	1,00	0,00	NR	0,00	NR	
Articolo	06922700	ADESIVO FRECCIA ALLINEAMENTO L=50x15 (**)		Si	2,00	0,00	NR	0,00	NR	
Articolo	06998800	ADESIVO DEVIATORE POMPA MANUALE PIATTAFORMA GL17.		Si	1,00	0,00	NR	0,00	NR	

F g w c i r l q ' f k u l p v c

distinta 17788100	Descrizione KIT ADESIVI DI SICUREZZA PER PIATTAFORMA AEREA JLG/CE - X			quantità componenti percentuale <input type="checkbox"/>	Disegno
Tipo Articolo	Data creazione 06/04/2016	Data ultimo aggiorn 03/10/2017	Unità di misura NR	Nota	

Tipo	Componente	Descrizione	N.F.	Da Espl.	Quantità	Qtà perc.	Un. mis.	Quantità sfridi	Un. mis.	Nota
		80XL L=86X34 MM								
Articolo	07056700	ADESIVO JLG DIVIETO DI SOLLEVAMENTO L=54,88X40		Si	8,00	0,00	NR	0,00	NR	
Articolo	07056800	ADESIVO JLG DISCESA DI EMERGENZA ALL'INTERNO L=114X130 MM_MOD_B		Si	3,00	0,00	NR	0,00	NR	
Articolo	07058800	ADESIVO PERICOLO MANTENERE LE DISTANZE L=65X130 MM - GIALLO		Si	2,00	0,00	NR	0,00	NR	
Articolo	07071000	ADESIVO JLG CLAXON SU PIATTAFORME L=39,3X28,55 MM_MOD_ B		Si	1,00	0,00	NR	0,00	NR	
Articolo	07071200	ADESIVO JLG PUNTO DI SOLLEVAMENTO L= 40X66 MM		Si	8,00	0,00	NR	0,00	NR	
Articolo	07240300	ADESIVO DISTANZA 1 METRO SU TELE/RADIO COMANDI L= 75x35 MM_MOD_B		Si	1,00	0,00	NR	0,00	NR	
Articolo	07668200	ADESIVO EMERGENCY STOP E BLOCCHETTO ACCENSIONE L= 85x160 MM_MOD_B		Si	1,00	0,00	NR	0,00	NR	
Articolo	07668300	ADESIVO SELETTORE SCATOLA COMANDI TERRA / CESTO L= 105X155 MM		Si	1,00	0,00	NR	0,00	NR	
Articolo	07799200	ADESIVO REAZIONE AL SUOLO STABILIZZATORI LL1570 1670 daN L=45x48 MM		Si	4,00	0,00	NR	0,00	NR	
Articolo	07878400	ADESIVO CASCO IMBRAGATURA E DIVIETI LL1370 L=175X118 MM		Si	1,00	0,00	NR	0,00	NR	
Articolo	07839500	ADESIVO SOLLEVAMENTO PIATTAFORMA CON MULETTO - PICCOLO L=65X50 MM		Si	4,00	0,00	NR	0,00	NR	
Articolo	1001125483	ADESIVO JLG VIETATO LAVARE L=63,5X63,5 MM		Si	7,00	0,00	NR	0,00	NR	
Articolo	1608710002	ADESIVO PULSANTI DISTRIBUTORE A TERRA LATO DX GL17.80 L L=150X50 MM_MOD_C		Si	1,00	0,00	NR	0,00	NR	
Articolo	1701504	ADESIVO JLG OLIO IDRAULICO L=50,8x63,5 MM (**)		Si	1,00	0,00	NR	0,00	NR	
Articolo	1702155	ADESIVO JLG STACCABATTERIA L= 63,5X50,80 MM		Si	1,00	0,00	NR	0,00	NR	
Articolo	1703814	ADESIVO JLG ATTACCO ANCORAGGIO L=55,56X76,2 MM		Si	4,00	0,00	NR	0,00	NR	
Articolo	1704125	ADESIVO JLG ATTACCO ARIA E ACQUA L=25,4X76,2 MM		Si	1,00	0,00	NR	0,00	NR	
Articolo	1704277	ADESIVO JLG ATTACCO CINTURE DI SICUREZZA L= 76,2X19,05 MM		Si	2,00	0,00	NR	0,00	NR	

AGGIORNATO IL / UPDATED 02/11/2016

**KIT ADESIVI COMMERCIALI PER PIATTAFORMA AEREA /
*STICKERS KIT COMMERCIAL FOR AERIAL PLATFORM***

JLG/CE X15JPLUS

Cod. 17788200

DA USARE CON / FOR USE WITH
COD. 17788100 *KIT ADESIVI DI SICUREZZA PER PIATTAFORMA AEREA / STICKER KITS SECURITY AERIAL
PLATFORM*

A STABILIZZATORI CHIUSI CENTRARE SUL BRACCIO SIA IN ALTEZZA CHE IN LARGHEZZA IL LOGO JLG LIFT
A CLOSED CENTRALISE REGULATORS ON ARM IS IN HEIGHT TO WIDTH IN THE LOGO JLG LIFT

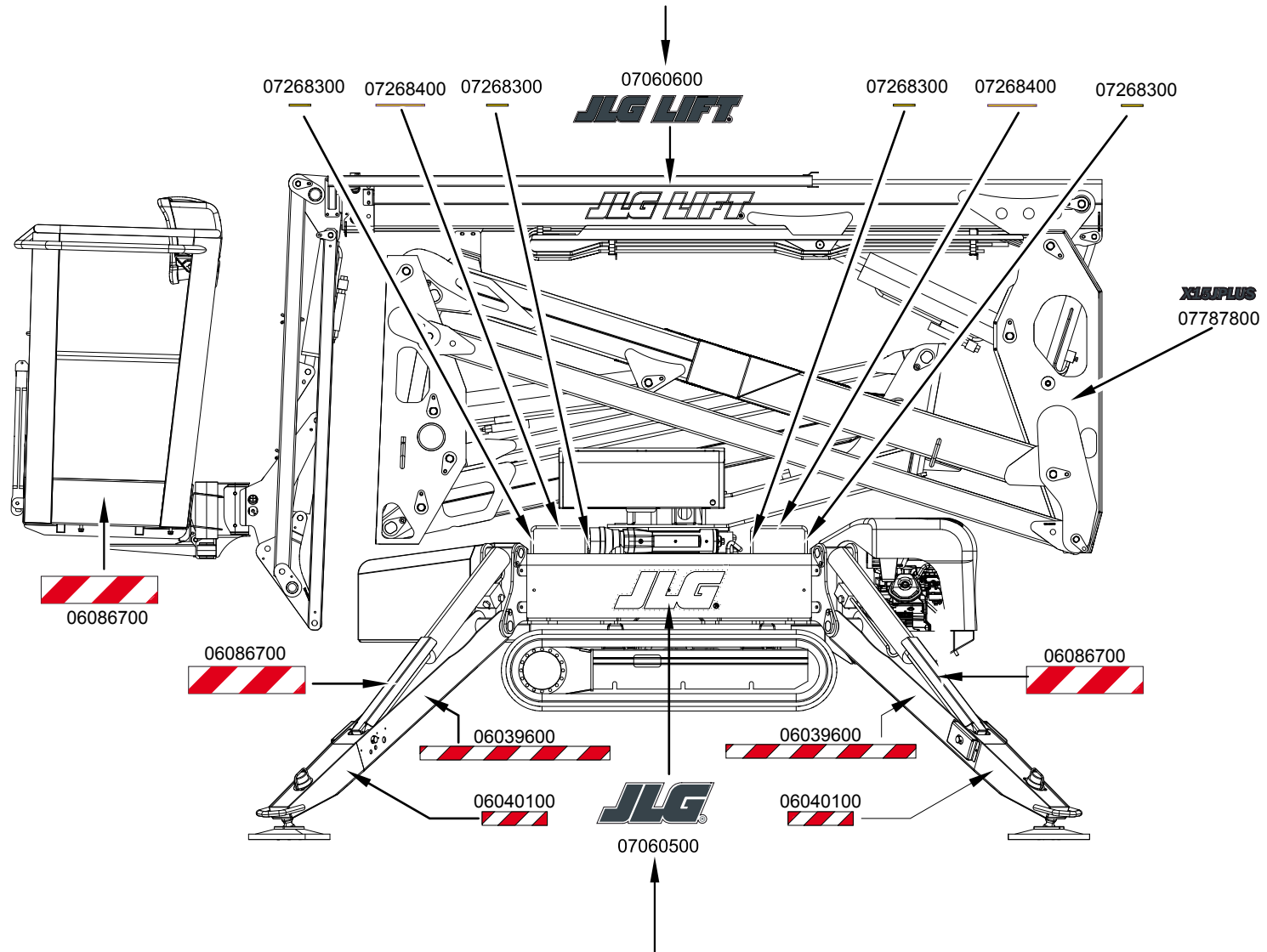

A STABILIZZATORI CHIUSI CENTRARE SUL COPERCHIO SIA IN ALTEZZA CHE IN LARGHEZZA IL LOGO JLG
A CLOSED CENTRALISE REGULATORS ON THE COVER IS IN HEIGHT TO WIDTH IN THE LOGO JLG

A STABILIZZATORI CHIUSI CENTRARE SUL BRACCIO SIA IN ALTEZZA CHE IN LARGHEZZA IL LOGO JLG LIFT
A CLOSED CENTRALISE REGULATORS ON ARM IS IN HEIGHT TO WIDTH IN THE LOGO JLG LIFT

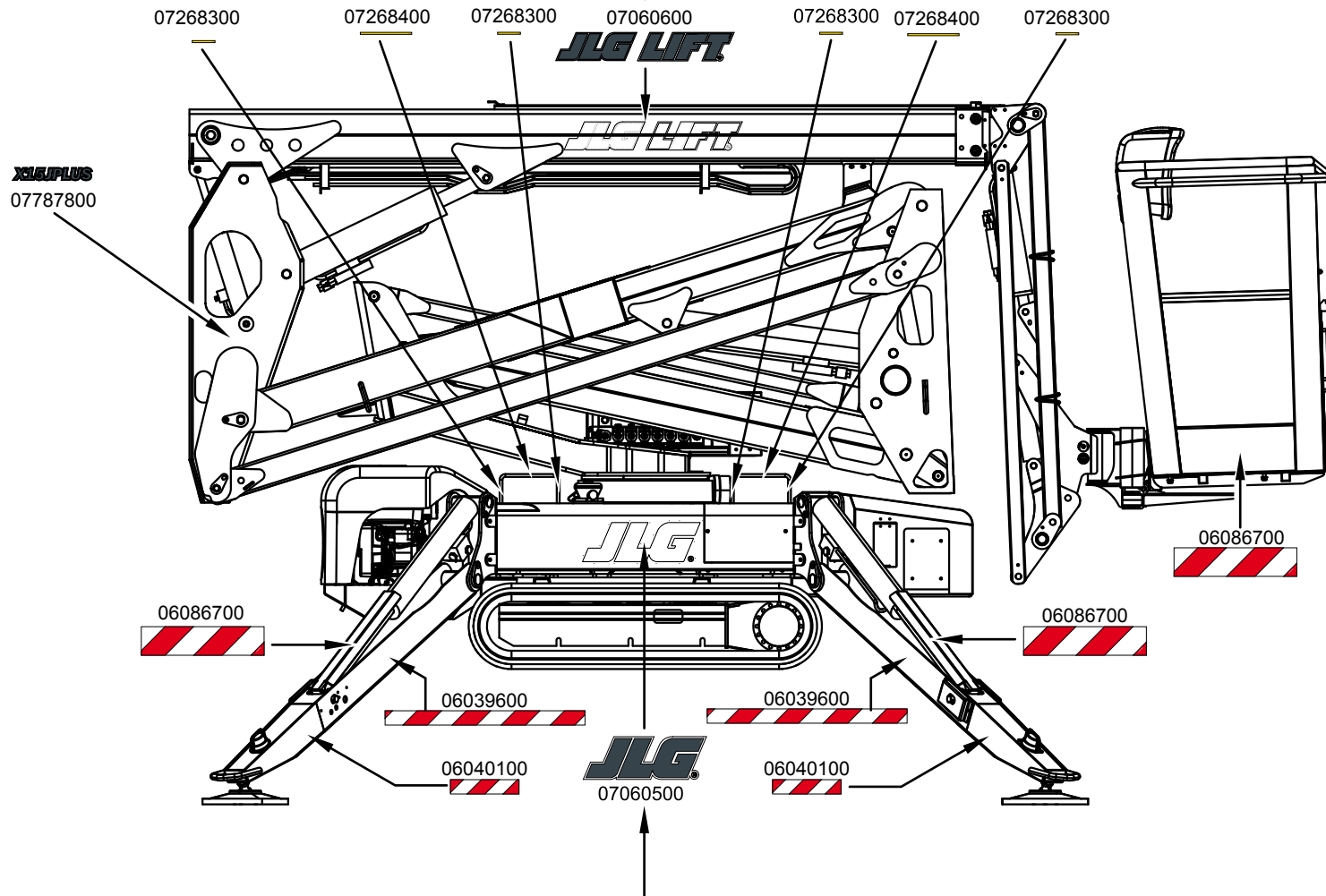

X15JPLUS
07787800

A STABILIZZATORI CHIUSI CENTRARE SUL COPERCHIO SIA IN ALTEZZA CHE IN LARGHEZZA IL LOGO JLG
A CLOSED CENTRALISE REGULATORS ON THE COVER IS IN HEIGHT TO WIDTH IN THE LOGO JLG

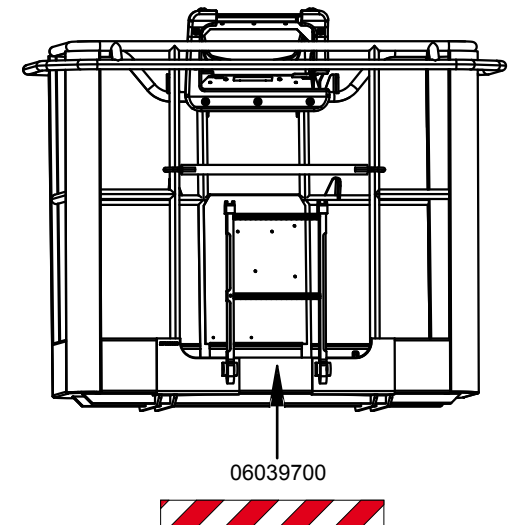



AGGIORNATO IL / UPDATED 28/11/2019

**KIT ADESIVI SICUREZZA PER PIATTAFORMA AEREA /
*STICKERS KIT SECURITY FOR AERIAL PLATFORM***

JLG/ANSI - X370AJ - JLG/ANSI X430AJ

Cod. 17788300

+ kit in lingua non incluso nel codice generale / *kit in the language not included in the general code*

177883GB / 177883FR / 177883ES / 177883PT

DA USARE CON / FOR USE WITH

**COD. 17859200 KIT ADESIVI COMMERCIALI PER PIATTAFORMA AEREA / *STICKER KITS COMMERCIAL AERIAL PLATFORM*
JLG/CE X370AJ**

DA USARE CON / FOR USE WITH

**COD. 17788400 KIT ADESIVI COMMERCIALI PER PIATTAFORMA AEREA / *STICKER KITS COMMERCIAL AERIAL PLATFORM*
JLG/CE X430AJ**

**16924900 KIT INTEGRAZIONE ADESIVI PIATTAFORME 3S LITHIUM /
*STICKER KIT INTEGRATION PLATFORM LITHIUM***

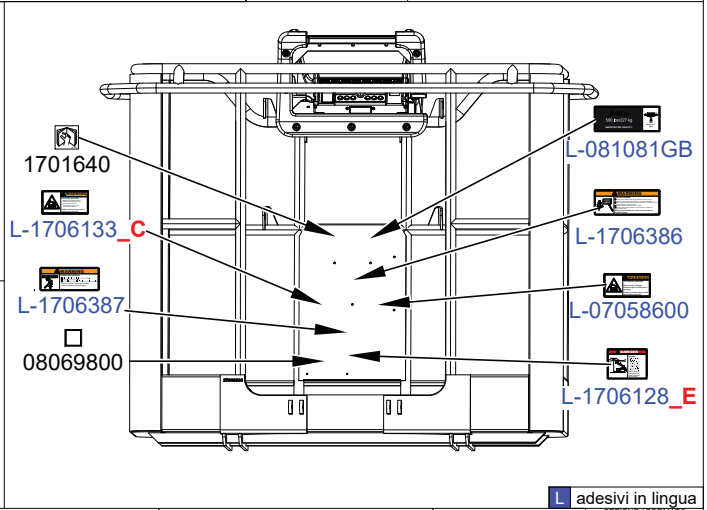
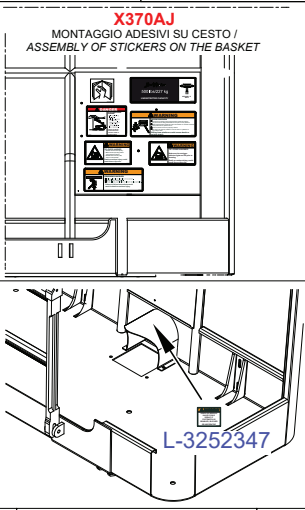
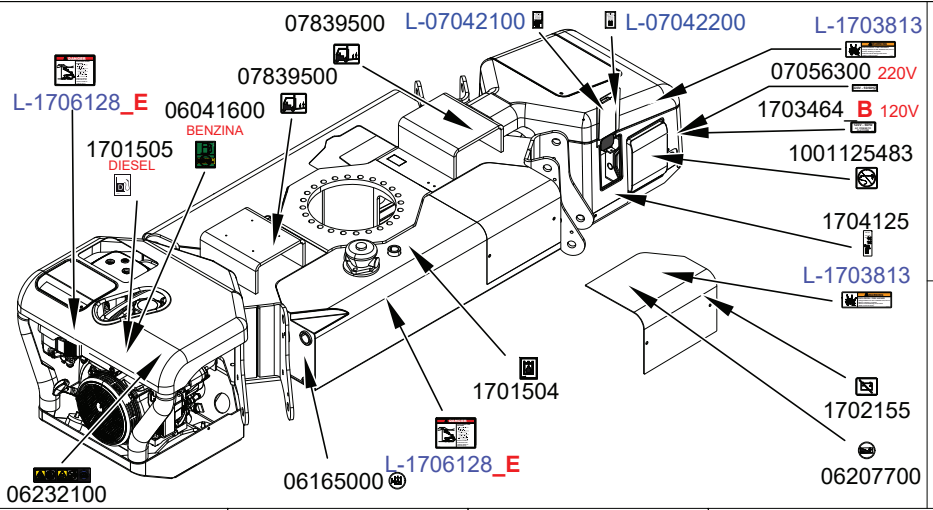
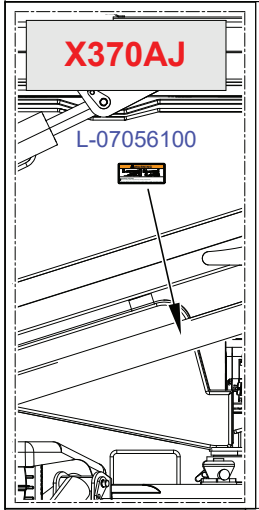
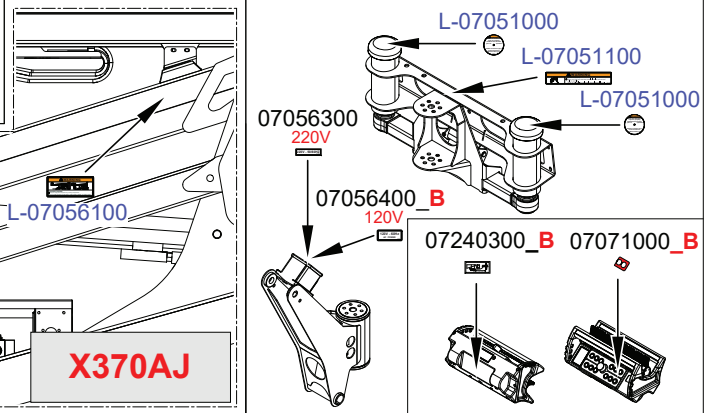
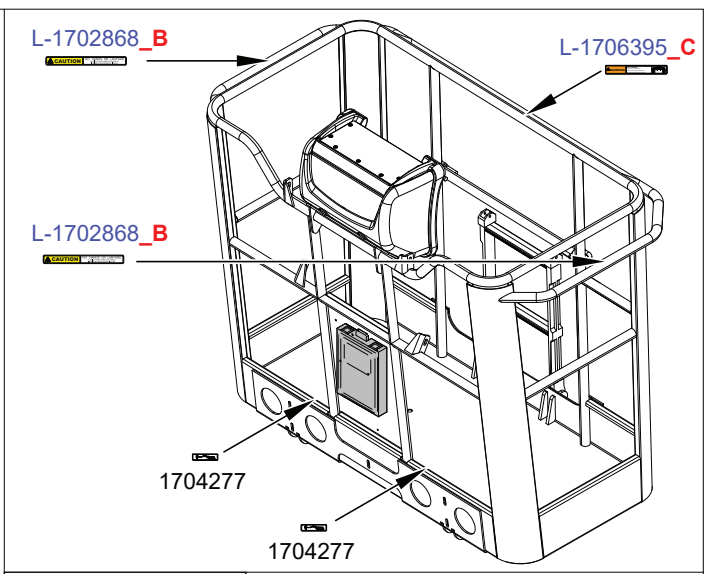
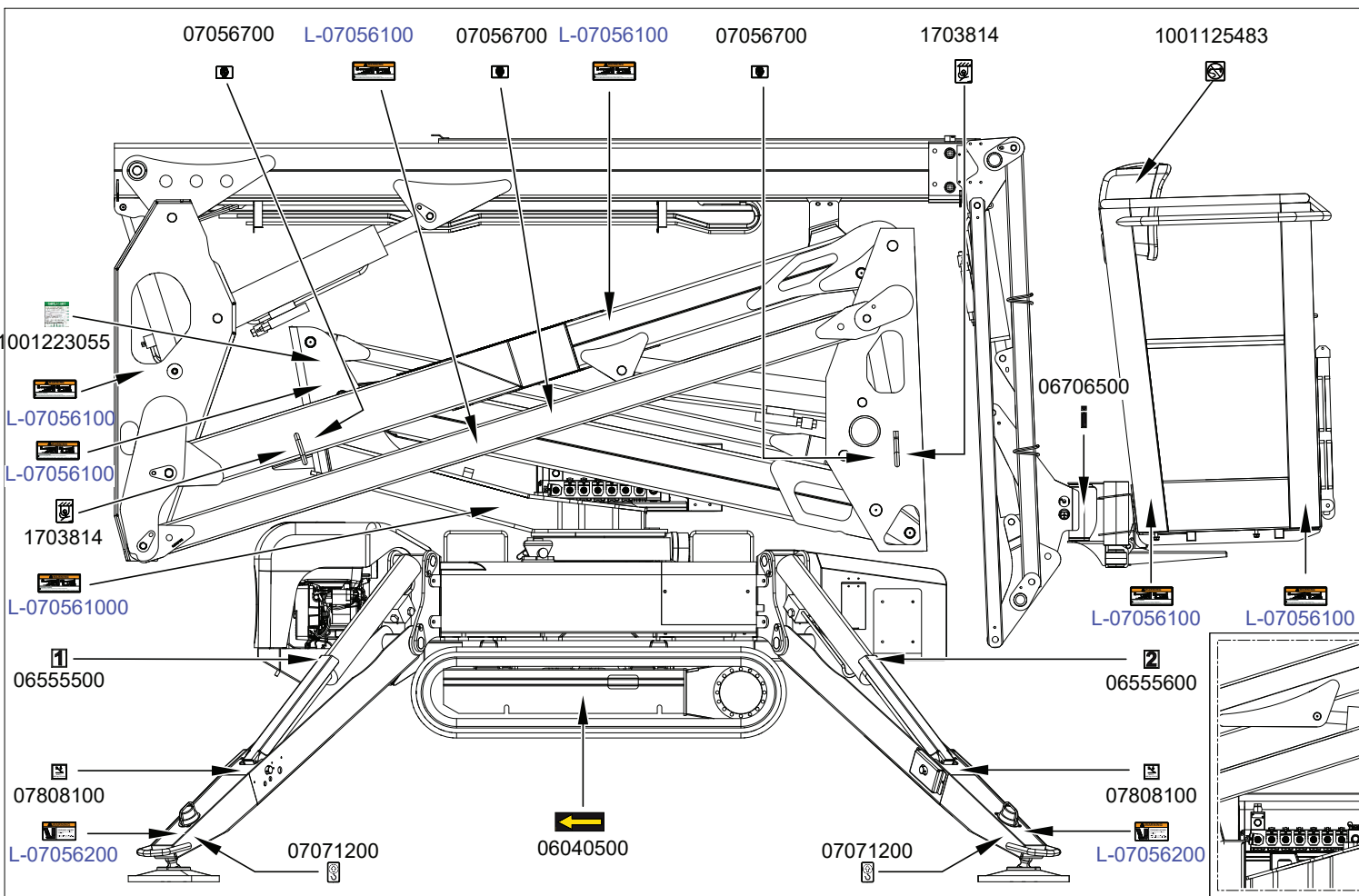

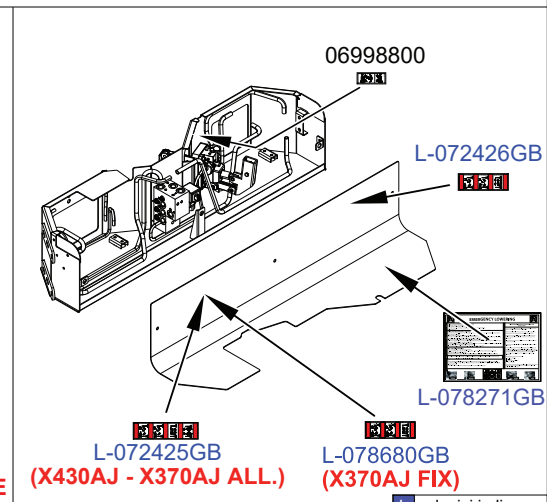
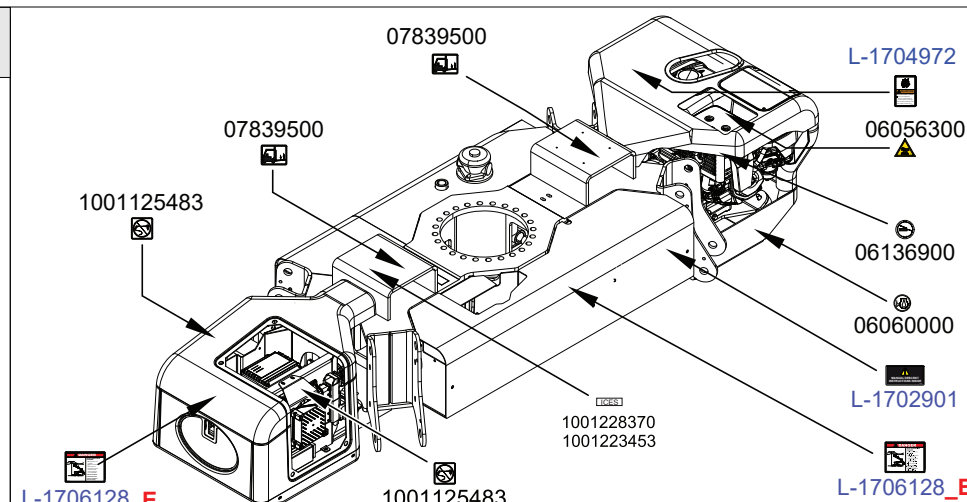
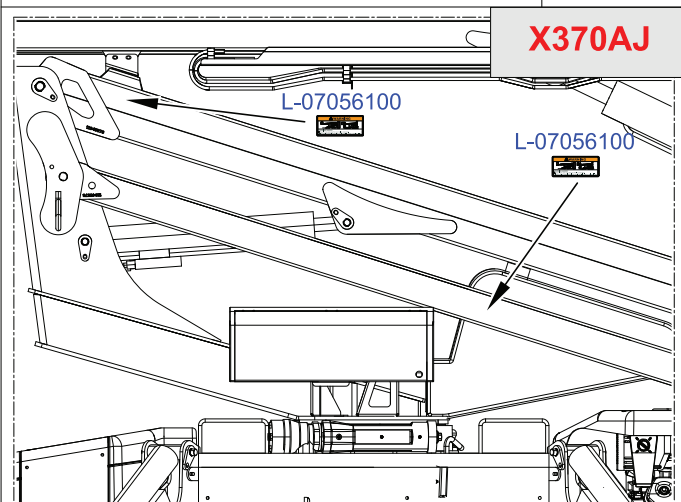
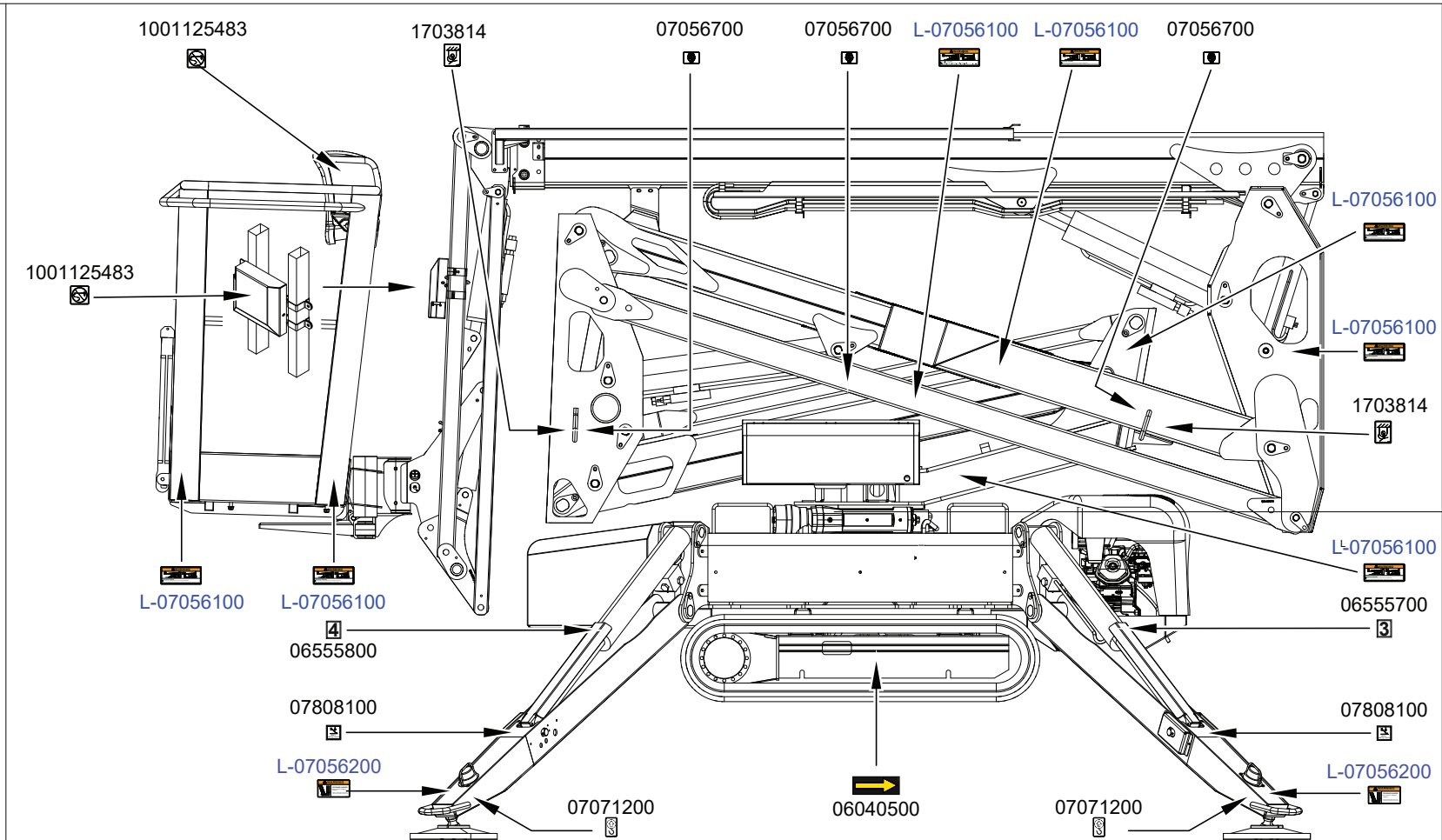
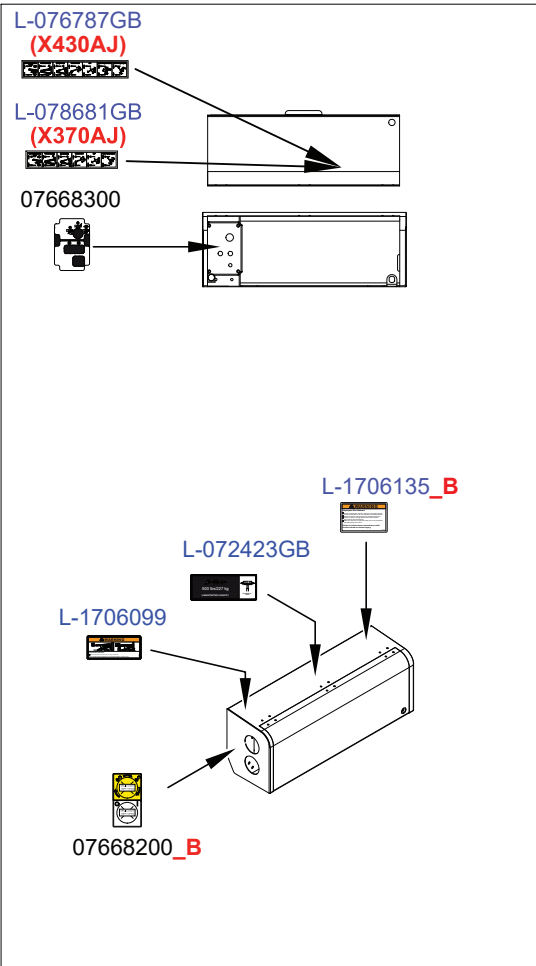

JLG/ANSI - X370AJ / X430AJ ELENCO ADESIVI / LIST STICKERS COD. 17788300

----	COD.	DESCRIZIONE / DESCRIPTION	Q.tà
	06040500	ADESIVO DIREZ. TRASLAZIONE FRECCIA GIALLA SFONDO NERO L=61 X 160	02
	06041600	ADESIVO CARBURANTE BENZINA COLORE VERDE L=60 X 80 MM _MOD_B	01
	06056300	ADESIVO PERICOLO SCOTTATURE TRIANGOLARE SFONDO GIALLO L=60X51 MM	01
	06060000	ADESIVO LIVELLO OLIO MOTORE Ø50 MM	01
	06136900	ADESIVO PUNTI INGRASSAGGIO Ø 55 TESTO NERO - SFONDO BIANCO	01
	06165000	ADESIVO LIVELLO OLIO IDRAULICO Ø50 MM	01
	06207700	ADESIVO BATTERIA POLO POSITIVO POLO NEGATIVO BIANCO Ø50	01
	06232100	ADESIVO JLG CARBURANTE BENZINA L= 101X63,5 (**) _MOD_B	01
	06555500	ADESIVO NR 1 L=50X60 BIANCO	01
	06555600	ADESIVO NR 2 L=50X60 BIANCO	01
	06555700	ADESIVO N° 3 L=50X60 BIANCO	01
	06555800	ADESIVO N° 4 L=50X60 BIANCO	01
	06706500	ADESIVO ALLINEAMENTO CESTO (2 PEZZI) L=16X50+13 MM	01
	06998800	ADESIVO DEVIATORE POMPA MANUALE PIATTAFORMA GL17.80XL L=86X34 MM	01
	07056300	ADESIVO JLG PERICOLO 220V - 50/60HZ L= 75X18,75 MM	02
	07056700	ADESIVO JLG DIVIETO DI SOLLEVAMENTO L=40X54,88 MM	06
	07071000	ADESIVO JLG CLAXON SU PIATTAFORME L=39,3X28,55 MM _MOD_B	01
	07071200	ADESIVO JLG PUNTO DI SOLLEVAMENTO L= 40X66 MM	08
	07240300	ADESIVO DISTANZA 1 METRO SU TELE/RADIO COMANDI L= 75x35 MM _MOD_B	01
	07808100	ADESIVO REAZIONE AL SUOLO STABILIZZATORI X430AJ L= 50X50 MM	04
	07668200	ADESIVO EMERGENCY STOP E BLOCCHETTO ACCENSIONE L=85x160 MM _MOD_B	01
	07668300	ADESIVO SELETTORE SCATOLA COMANDI TERRA / CESTO L=105X155 MM	01
	07839500	ADESIVO SOLLEVAMENTO PIATTAFORMA CON MULETTO - PICCOLO L=65X50 MM	04
	1001125483	ADESIVO JLG VIETATO LAVARE L=63,5X63,5 MM	06

ELENCO ADESIVI IN LINGUA / LIST LANGUAGE STICKERS COD. / CODE 177883GB_177883FR_177883ES_177883PT

JLG

COD.				DESCRIZIONE / DESCRIPTION	Q.tà
177883FR	177883PT	177883ES	177883GB	ADESIVI IN LINGUA PER JLG/ANSI X430AJ - LINGUA INGLESE / FRANCESE / PORTOGHESE / SPAGNOLO	
07115200	07119800		07042100	ADESIVO JLG SISTEMA BYPASS PARTE AEREA - ING L=30X50 (**)	01
07115300	07119900		07042200	ADESIVO JLG SISTEMA BYPASS TRASLAZIONE - ING L= 30X50 (**)	01
07116600	07121200		07051000	ADESIVO JLG ATTENZ.CADUTE - SBLOCCARE SOLO NEI CASI PREVISTI - ING D Ø 60 FORO 4 MM (**)	02
07116700	07121300		07051100_B	ADESIVO JLG PERICOLO CADUTA - RIPRISTINARE I TAPPI - ING L=196,5x35 MM _MOD_B	01
07116800	07121400		07056100	ADESIVO JLG PERICOLO SCHIACCIAMENTO - ING L= 140x60,71 MM	16
07116900	07121500		07056200	ADESIVO JLG ATTACCO SCHIACCIAMENTO ARTO INFERIORE - ING L= 110x60 MM (PRES. STABILIZZAZTORI	04
07117200	07121800		07058600	ADESIVO JLG POSIZIONE STABILIZZATORI X390 - X550 - ING L= 139,7X69,85 MM	01
081081FR	081081PT		081081GB	ADESIVO JLG/ ANSI CARICO MAX IN CESTA X1000AJ - L=196, 85x76,2 MM	02
072425FR	072425PT		072425GB	ADESIVO JLG ANSI PULSANTI DISTRIBUTORI A TERRA LATO SX X500AJ - ING L=194X50 MM	01
072426FR	072426PT		072426GB	ADESIVO JLG ANSI PULSANTI DISTRIBUTORI A TERRA LATO DX X500AJ - ING L=150X50 MM	01
078271FR	078271PT		078271GB	ADESIVO JLG DISCESA DI EMERGENZA X430AJ MOTORE TERMICO E LITHIUM - ING L=290X205 MM	01
076787FR	076787PT		076787GB	ADESIVO JLG ANSI PULSANTI DISTRIBUTORE PARTE AEREA X770AJ - ING L=318X52 MM	01
078680FR	078680PT		078680GB	ADESIVO JLG/ANSI PULSANTI DISTRIBUTORE A TERRA X430AJ LATO SX - ING L=150X50 MM	01
078681FR	078681PT		078681GB	ADESIVO JLG/ANSI PULSANTI DISTRIBUTORE PARTE AEREA X430AJ - ING L=274X52 MM	01
07117800	07122400		1702868_B	ADESIVO JLG PERICOLO SCHIACCIAMENTO MANO - ING L= 241,30X25.40 MM _MOD_B (**)	02
07117900	07122500		1702901	ADESIVO JLG ISTRUZIONI DISCESA EMERGENZA / POMPA MANUALE - ING L=114,3x58,73MM	01
07118200	07122800		1703813	ADESIVO JLG PERICOLO ESPLOSIONE BATTERIE - ING L=149, 25X47,62 MM	02
07892700	07892800		1703464	ADESIVO JLG PERICOLO 120 VOLT 60HZ - ING L= 75x32.68 MM _MOD_B	02
07118300	07122900		1704972_C	ADESIVO JLG PERICOLO ESPLOSIONE - ING L=63,5x92,07 MM _MOD_C	01
08069800	08069800		08069800	ADESIVO JLG ATTENZIONE PROP.65 L=101,6X57,1 MM RIF JLG CODE. 1001231801C	01
07118500	07123100		1706099	ADESIVO JLG PERICOLO SCHIACCIAMENTO - ING L= 161,925X69, 85 MM (A TERRA)	01
07118600	07123200		1706128_E	ADESIVO JLG PERICOLO FOLGORAZIONE - ING L=120,65x91,50 MM _MOD_E	05
07118700	07123300		1706133_C	ADESIVO JLG PERICOLO RIBALTAMENTO - ING L=139,7X68,85 MM _MOD_C	01



AGGIORNATO IL / UPDATED 29/11/2019

**KIT ADESIVI COMMERCIALI PER PIATTAFORMA AEREA /
*STICKERS KIT COMMERCIAL FOR AERIAL PLATFORM***

JLG/ANSI X430AJ

Cod. 17788400

COD. 17788300 *DA USARE CON / FOR USE WITH*
**KIT ADESIVI DI SICUREZZA PER PIATTAFORMA AEREA / STICKER KITS SECURITY AERIAL PLAT-
FORM**

A STABILIZZATORI CHIUSI CENTRARE SUL BRACCIO SIA IN ALTEZZA CHE IN LARGHEZZA IL LOGO JLG LIFT
A CLOSED CENTRALISE REGULATORS ON ARM IS IN HEIGHT TO WIDTH IN THE LOGO JLG LIFT

centrare il logo in altezza e larghezza fra lo spazio rimanente
 center the logo in height and width among the remaining space

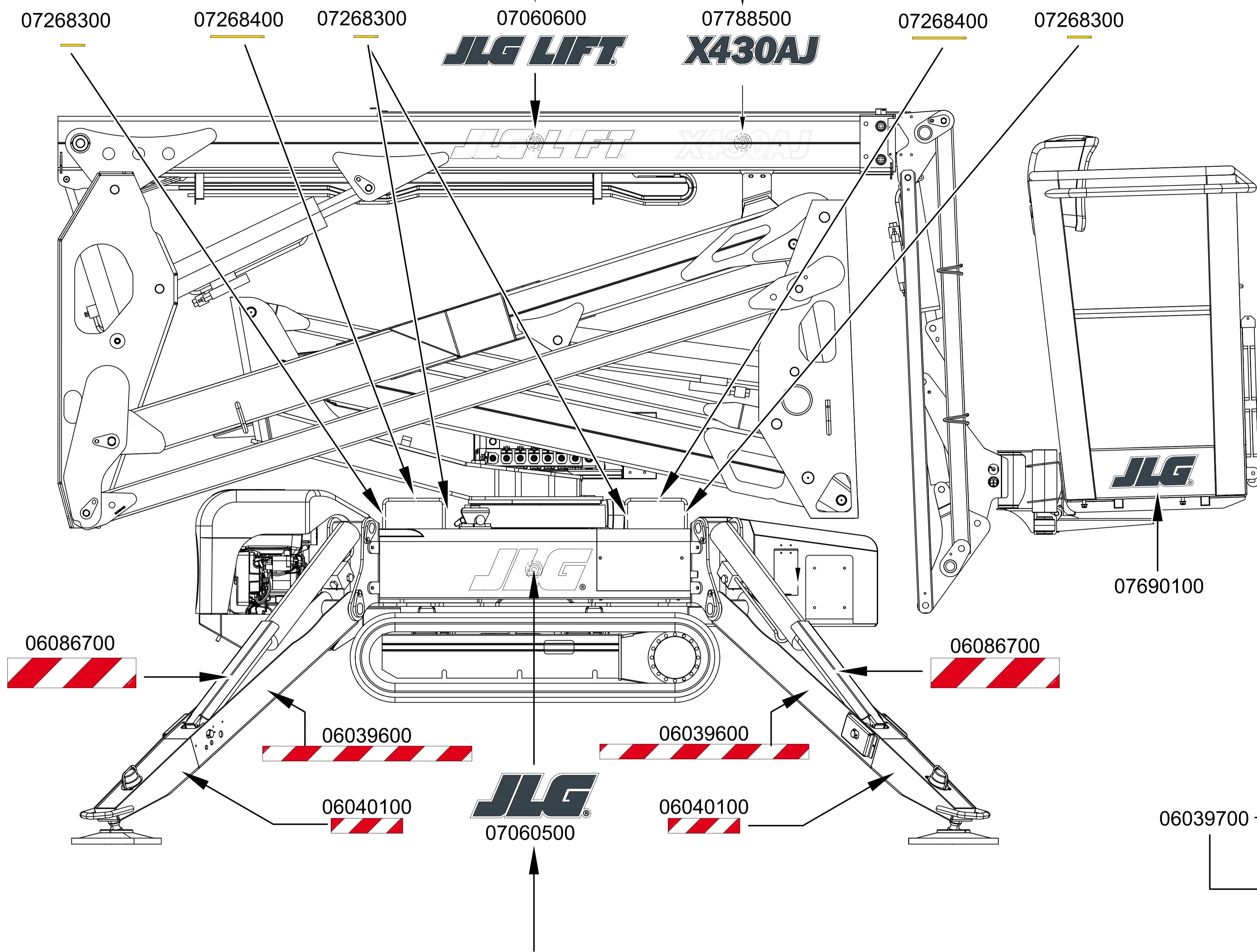

A STABILIZZATORI CHIUSI CENTRARE SUL COPERCHIO SIA IN ALTEZZA CHE IN LARGHEZZA IL LOGO JLG
A CLOSED CENTRALISE REGULATORS ON THE COVER IS IN HEIGHT TO WIDTH IN THE LOGO JLG

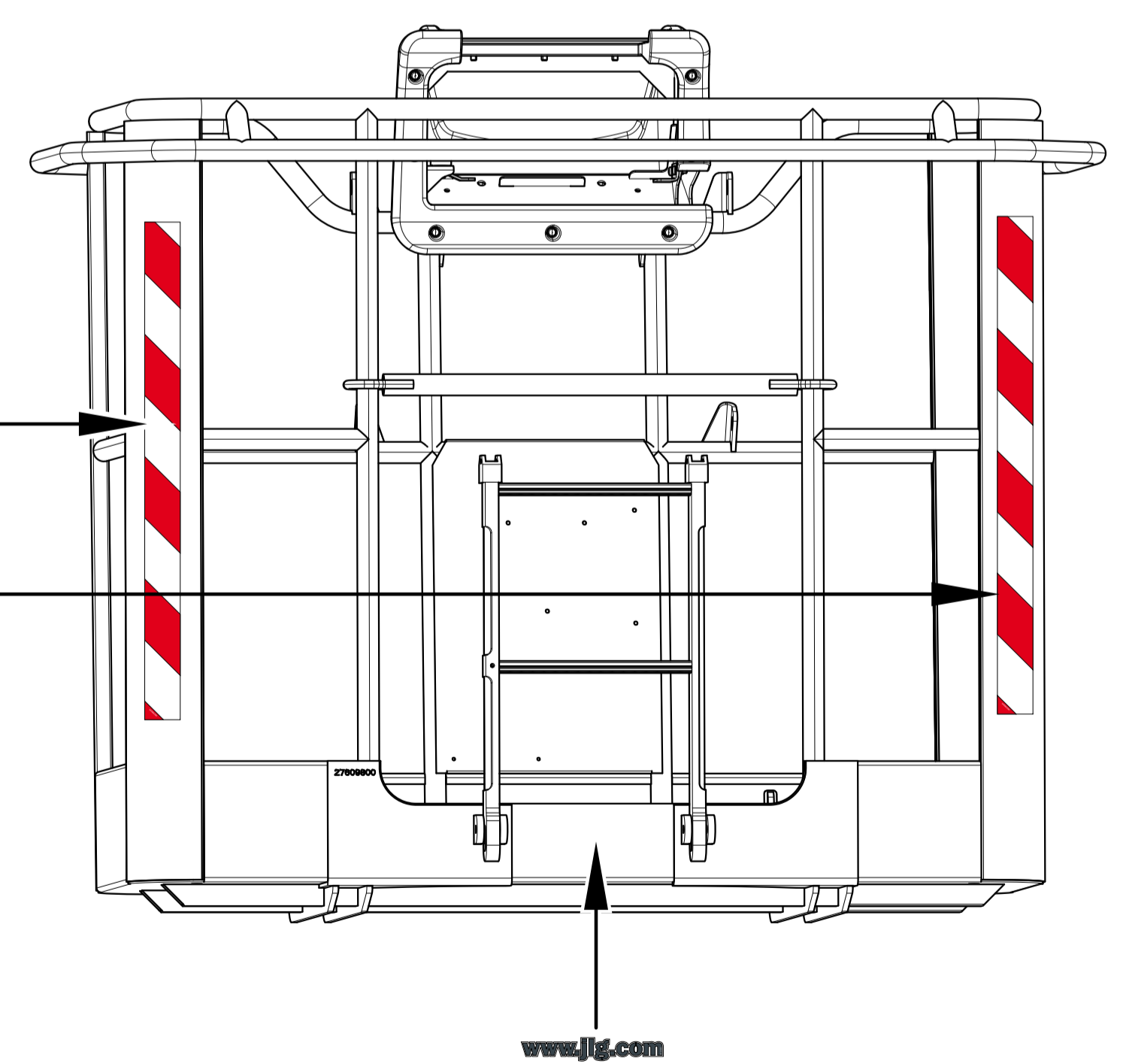



AGGIORNATO IL / UPDATED 30/10/2019

KIT ADESIVI CESTO MONOPOSTO E BIPOSTO PER PIATTAFORME AEREE /
BASKET KIT STICKERS SINGLE POSTAND TANDEM FOR PLATFORMS

SERIE/SERIES JLG/CE

X14J • X17J • X19J • X23J
X13JPLUS • X15JPLUS • X17JPLUS • X20JPLUS • X26JPLUS

CON MOTORE TERMICO E LITHIUM / WITH HEAT ENGINE AND LITHIUM

Cod. 17876800

+ kit adesivi portata cesto non inclusi nel codice generale
Sticker kits basket capacity not included in the standard kit

178768X14J / 178768X17J / 178768X19J / 178768X23J
178768X13JP / 178768X15JP / 178768X17JP / 178768X20JP / 178768X26JP

+ kit in lingua non inclusi nel codice generale
language code not included in the standard kit

174164IT / 1174164GB / 174164FR / 174164DE / 174164ES / 174164NL / 174164SW / 174164PT /
174164DA / 174164NO / 174164RU / 174164PL / 174164SL / 174164FI / 174164CE / 174164JA

JLG/CE X13JPLUS • X15JPLUS • X17JPLUS • X20JPLUS • X26JPLUS

JLG/CE 14J • X17J • X19J • X23J

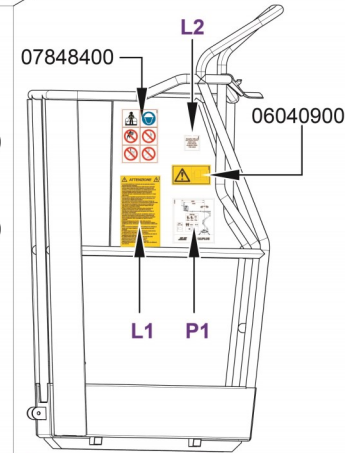
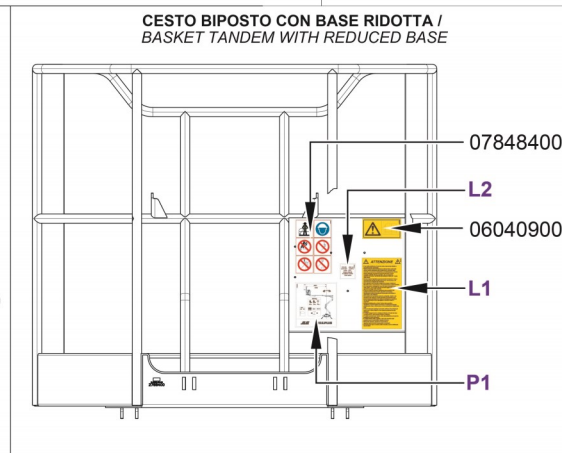
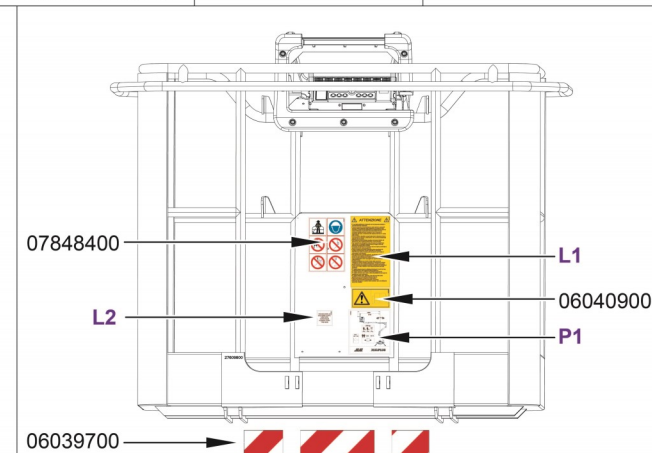
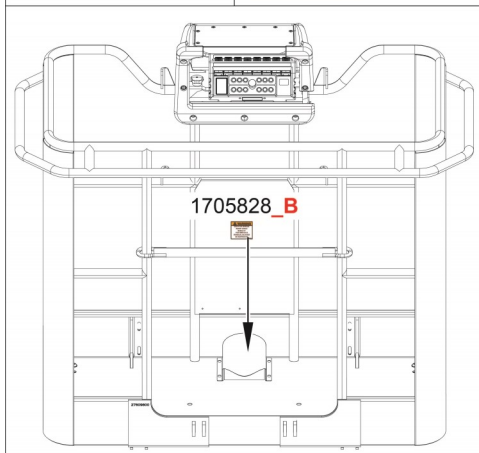
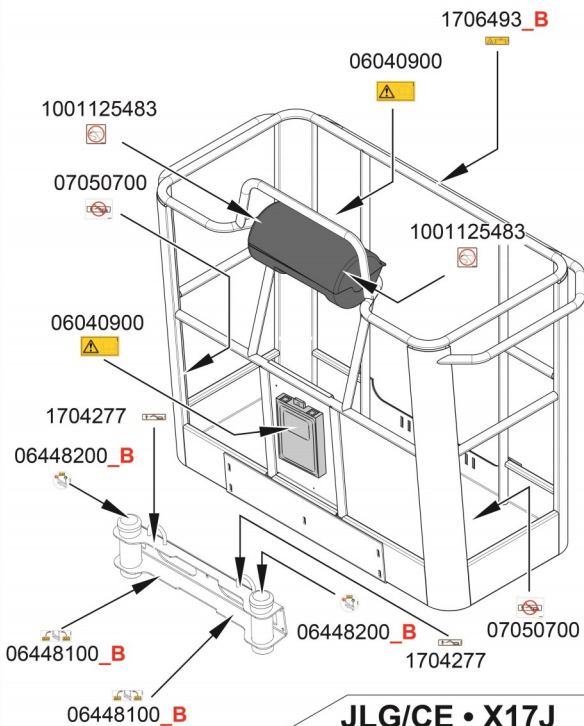
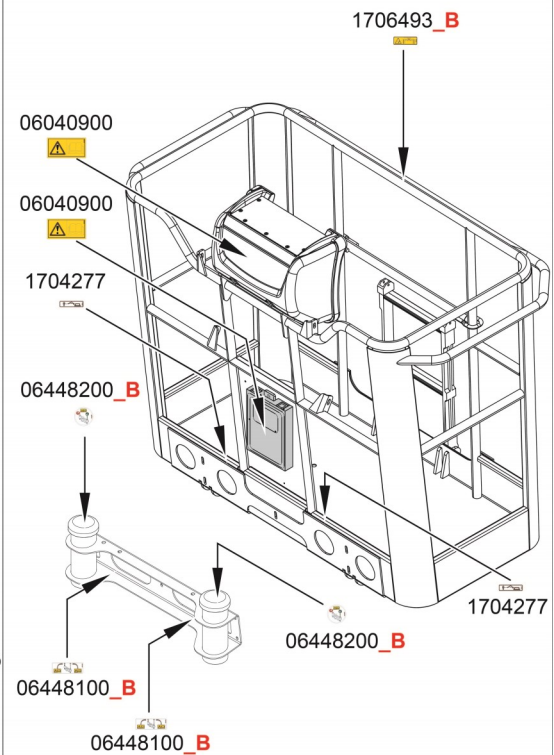
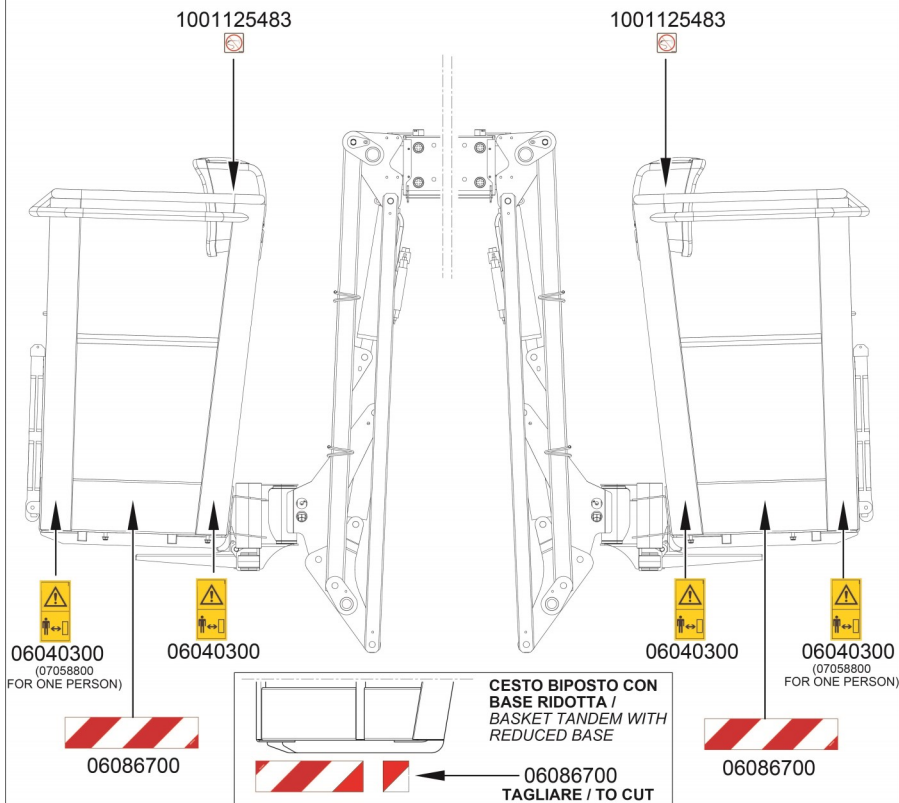

JLG/CE • X17J

KIT ADESIVI CESTO / ADHESIVE KIT BASKET / AUTOCOLLANTS PANIER KIT / AUFKLEBER-KIT BASKET / KIT DE ETIQUETA CESTA / STICKERS KIT DE MAND VAN
X14J_X17J_X19J_X23J ... X13JPLUS_X15JPLUS_X17JPLUS_X20JPLUS_X26JPLUS

SCALA 1:8 COD. 17878600 TAV. 01 A1

P Kit portata cesto L Kit adesivi in lingua

SERIE / SERIES JLG /CE COD. 178768 POSIZIONE ADESIVI PORTATA CESTO /POSITION ADHESIVE**

POS.	COD.	REV.	DESCRIZIONE / DESCRIPTION	Q.tà
P1	178768X14J		KIT ADESIVI PORTATA CESTO X14J CON MOTORE TERMICO E LITHIUM	
	07059400	A	ADESIVO JLG PORTATA CESTO 2 PERSONE X14J L=135X145 MM	01
	07059300	A	ADESIVO JLG PORTATA CESTO 1 PERSONA X14J L=135X145 MM	01
P1	178768X17J		KIT ADESIVI PORTATA CESTO X17J CON MOTORE TERMICO E LITHIUM	
	07059600	A	ADESIVO JLG PORTATA CESTO 2 PERSONE X17J L=135X145 MM	01
	07059500	A	ADESIVO JLG PORTATA CESTO 1 PERSONA X17J L=135X145 MM	01
P1	178768X19J		KIT ADESIVI PORTATA CESTO X19J CON MOTORE TERMICO E LITHIUM	
	07059800	A	ADESIVO JLG PORTATA CESTO 2 PERSONE X19J L=135X145 MM	01
	07059700	A	ADESIVO JLG PORTATA CESTO 1 PERSONA X19J L=135X145 MM	01
P1	178768X23J		KIT ADESIVI PORTATA CESTO X23J CON MOTORE TERMICO E LITHIUM	
	07060000	A	ADESIVO JLG PORTATA CESTO 2 PERSONE X23J L=135X145 MM	01
	07059900	A	ADESIVO JLG PORTATA CESTO 1 PERSONA X23J L=135X145 MM	01
P1	178768X13JP		KIT ADESIVI PORTATA CESTO X13JPLUS CON MOTORE TERMICO E LITHIUM	
	07868200	A	ADESIVO JLG PORTATA CESTO 2 PERSONE X13JPLUS L=135X145 MM	01
	07868400	A	ADESIVO JLG PORTATA CESTO 1 PERSONA X13JPLUS L=135X145 MM	01
P1	178768X15JP		KIT ADESIVI PORTATA CESTO X15JPLUS CON MOTORE TERMICO E LITHIUM	
	07799400	A	ADESIVO JLG PORTATA CESTO 2 PERSONE X15JPLUS L=135X145 MM	01
	07799500	A	ADESIVO JLG PORTATA CESTO 1 PERSONA X15JPLUS L=135X145 MM	01

SERIE / SERIES JLG / CE COD. 178768 POSIZIONE ADESIVI IN LINGUA / POSITION LANGUAGE STICKERS**

POS.	COD.	REV.	DESCRIZIONE / DESCRIPTION	Q.tà
	178768IT		ADESIVI IN LINGUA PER KIT CESTO SERIE JLG/CE X13_X15_X17_X20_X26 - ITALIANO	
L1	06555300	C	ADESIVO USO PIATTAFORMA AEREA CINGOLATA - ITALIANO L=128X230_MOD_C	01
L2	07188100	A	ADESIVO JLG-CE RICARICARE LE BATTERIE DOPO L'USO ALMENO OGNI 3 MESI - ITALIANO L=50x50 MM	01
	178768GB		ADESIVI IN LINGUA PER KIT CESTO SERIE JLG/CE X13_X15_X17_X20_X26 - INGLESE	
L1	06562600	C	ADESIVO USO PIATTAFORMA AEREA CINGOLATA - INGLESE L=128X230_MOD_C	01
L2	07202100	A	ADESIVO JLG-CE RICARICARE LE BATTERIE DOPO L'USO ALMENO OGNI 3 MESI - INGLESE L=50x50 MM	01
	178768FR		ADESIVI IN LINGUA PER KIT CESTO SERIE JLG/CE X13_X15_X17_X20_X26 - FRANCESE	
L1	06562700	C	ADESIVO USO PIATTAFORMA AEREA CINGOLATA - FRANCESE L=128X230_MOD_C	01
L2	07202200	A	ADESIVO JLG-CE RICARICARE LE BATTERIE DOPO L'USO ALMENO OGNI 3 MESI - FRANCESE L=50x50 MM	01
	178768DE		ADESIVI IN LINGUA PER KIT CESTO SERIE JLG/CE X13_X15_X17_X20_X26 - TEDESCO	
L1	06562800	C	ADESIVO USO PIATTAFORMA AEREA CINGOLATA - TEDESCO L=128X230_MOD_C	01
L2	07188200	A	ADESIVO JLG-CE RICARICARE LE BATTERIE DOPO L'USO ALMENO OGNI 3 MESI - TEDESCO L=50x50 MM	01
	178768ES		ADESIVI IN LINGUA PER KIT CESTO SERIE JLG/CE X13_X15_X17_X20_X26 - SPAGNOLO	
L1	06562900	C	ADESIVO USO PIATTAFORMA AEREA CINGOLATA - SPAGNOLO L=128X230_MOD_C	01
L2	07202300	A	ADESIVO JLG-CE RICARICARE LE BATTERIE DOPO L'USO ALMENO OGNI 3 MESI - SPAGNOLO L=50x50 MM	01
	178768NL		ADESIVI IN LINGUA PER KIT CESTO SERIE JLG/CE X13_X15_X17_X20_X26 - OLANDESE	
L1	06563000	C	ADESIVO USO PIATTAFORMA AEREA CINGOLATA - OLANDESE L=128X230_MOD_C	01
L2	07188300	A	ADESIVO JLG-CE RICARICARE LE BATTERIE DOPO L'USO ALMENO OGNI 3 MESI - OLANDESE L=50x50 MM	01

SERIE / SERIES JLG / CE COD. 178768 POSIZIONE ADESIVI IN LINGUA / POSITION LANGUAGE STICKERS**

POS.	COD.	REV.	DESCRIZIONE / DESCRIPTION	Q.tà
	178768SW		ADESIVI IN LINGUA PER KIT CESTO SERIE JLG/CE X13_X15_X17_X20_X26 - SVEDESE	
L1	07137300	C	ADESIVO USO PIATTAFORMA AEREA CINGOLATA - SVEDESE L= 128X230 MM _MOD_C	01
L2	07188400	A	ADESIVO JLG-CE RICARICARE LE BATTERIE DOPO L'USO ALMENO OGNI 3 MESI - SVEDESE L=50x50 MM	01
	178768PT		ADESIVI IN LINGUA PER KIT CESTO SERIE JLG/CE X13_X15_X17_X20_X26 - PORTOGHESE	
L1	06563100	C	ADESIVO USO PIATTAFORMA AEREA CINGOLATA - PORTOGHESE L=128X230 _MOD_C	01
L2	07202400	A	ADESIVO JLG-CE RICARICARE LE BATTERIE DOPO L'USO ALMENO OGNI 3 MESI - PORTOGHESE L=50x50 MM	01
	178768DA		ADESIVI IN LINGUA PER KIT CESTO SERIE JLG/CE X13_X15_X17_X20_X26 - DANESE	
L1	07138100	C	ADESIVO USO PIATTAFORMA AEREA CINGOLATA - DANESE L= 128X230 MM _MOD_C	01
L2	07188500	A	ADESIVO JLG-CE RICARICARE LE BATTERIE DOPO L'USO ALMENO OGNI 3 MESI - DANESE L=50x50 MM	01
	178768NO		ADESIVI IN LINGUA PER KIT CESTO SERIE JLG/CE X13_X15_X17_X20_X26 - NORVEGESE	
L1	07162000	C	ADESIVO USO PIATTAFORMA AEREA CINGOLATA - NORVEGESE L=128X230 MM _MOD_C	01
L2	07188600	A	ADESIVO JLG-CE RICARICARE LE BATTERIE DOPO L'USO ALMENO OGNI 3 MESI - NORVEGESE L=50x50 MM	01
	178768RU		ADESIVI IN LINGUA PER KIT CESTO SERIE JLG/CE X13_X15_X17_X20_X26 - RUSSO	
L1	07514800	A	ADESIVO USO PIATTAFORMA AEREA CINGOLATA - RUSSO L=128X230 MM	01
L2	07910300	A	ADESIVO JLG-CE RICARICARE LE BATTERIE DOPO L'USO ALMENO OGNI 3 MESI - RUSSO L=50x50 MM	01
	178768PL		ADESIVI IN LINGUA PER KIT CESTO SERIE JLG/CE X13_X15_X17_X20_X26 - POLACCO	
L1	07506600	B	ADESIVO USO PIATTAFORMA CINGOLATA LINGUA POLACCO L= 128X230MM _MOD_B	01
L2	07508100	A	ADESIVO JLG-CE RICARICARE LE BATTERIE DOPO L'USO ALMENO OGNI 3 MESI - POL ACCO L=50x50 MM	01

KIT INTEGRAZIONE ADESIVI
CESTO RETTANGOLARE DSE

DECALS KIT INTEGRATION
RECTANGULAR DSE BASKET

18374500

HISTORY REVISION

DATA/DATE	VERSION	MODIFICHE/CHANGES	AUTORE
01/04/2021	1.0	Realizzata nuova versione senza foto. New version without photos.	Masaggia Mattia

LISTA ADESIVI
DECALS LIST

CODE	DESCRIZIONE	QTA'
07058800	ADESIVO PERICOLO MANTENERE LE DISTANZE L=65X130 MM - GIALLO	2,00
08141300	ADESIVO NEW LOGO HINOWA GRAFFIATO H=40mm L=100mm	1,00
08347400	ADESIVO STRISCIA BIANCA E ROSSA H100 X L220 MM	2,00
08347500	ADESIVO STRISCIA BIANCA E ROSSA H100 X L350 MM	2,00
08318500	ADESIVO PRESPAZIATO CESTO DSE NERO	1,00

VEDI
MODELLO
MACCHINA

06040900

07878400

06040400

VEDI
MODELLO
MACCHINA

08141300

06448100

06448200

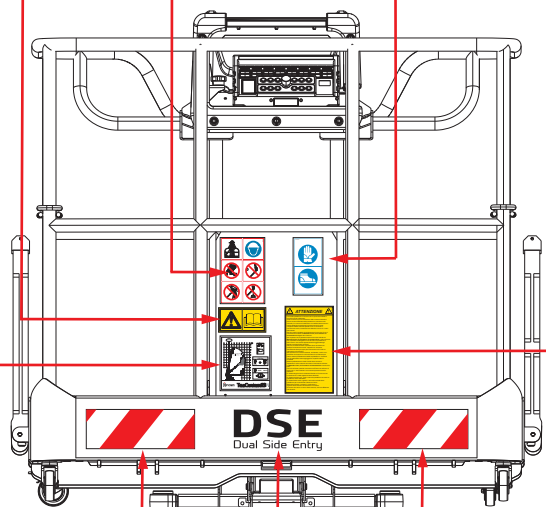

08347500

08318500

08347500

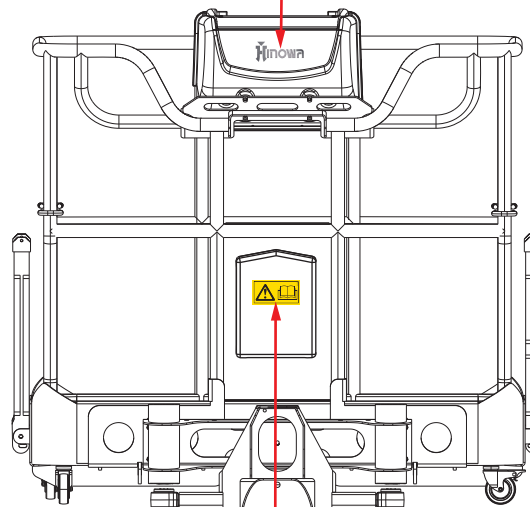

06040900

06448200

06448100



1001125483

1001125483

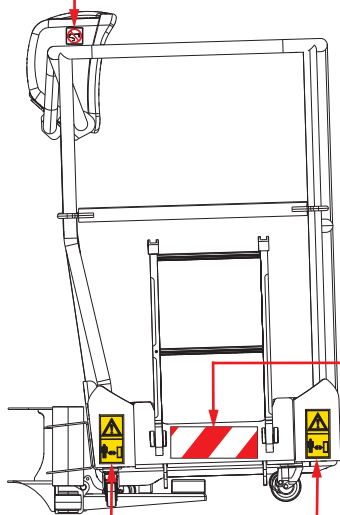

07058800

08347400

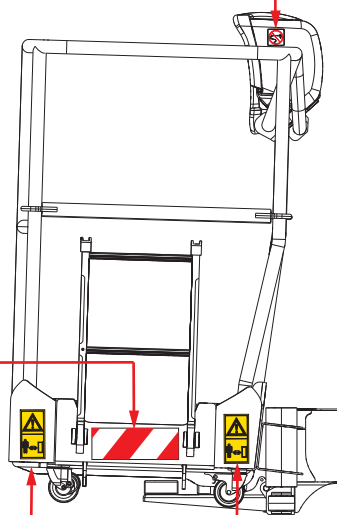

07058800

1704277

1704277

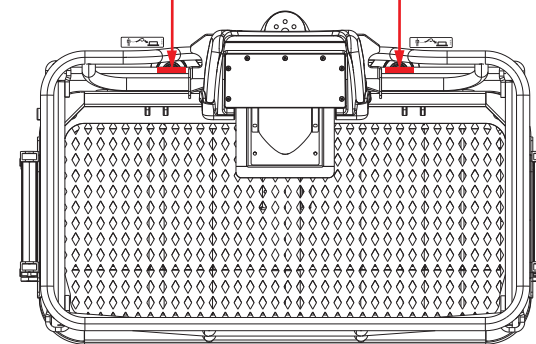

KIT INTEGRAZIONE ADESIVI
CESTO RETTANGOLARE DSE ANSI

DECALS INTEGRATION KIT
DSE RECTANGULAR BASKET ANSI

18486500

HISTORY REVISION

DATA/DATE	VERSION	MODIFICHE/CHANGES	AUTORE
24/01/2022	1.0	Realizzato nuovo KIT New KIT made	Masaggia Mattia

LISTA ADESIVI IN KIT CODE. 18486500**DECALS LIST KIT CODE 18486500**

POS	CODE			DESCRIZIONE DESCRIPTION	QTA QTY
	ENGLISH	FRENCH	PORTUGUESE		
L20	1706385	07118900	07123500	ADESIVO JLG SCORRIMENTO SBARRA CHIUSURA CESTO - ING L=184,15X25,4 MM_MOD_C	01

CODE	DESCRIPTION	QTY
1701640	ADESIVO JLG LEGGERE IL MANUALE L= 69,85x69,85 MM	01
08347500	ADESIVO STRISCIA BIANCA E ROSSA H100 X L350 MM	02
08347400	ADESIVO STRISCIA BIANCA E ROSSA H100 X L220 MM	02
07690100	ADESIVO JLG - LOGO JLG PER CESTO COLORE GRIGIO PANTONE 432C L=300x104,2 MM	01

LISTA ADESIVI CESTO COMPLETO COMPLETE BASKET DECALS LIST						
POS	CODE			DESCRIZIONE DESCRIPTION	QTA QTY	
	ENGLISH	FRENCH	PORTUGUESE			
L1	07056100	07116800	07121400	ADESIVO JLG PERICOLO SCHIACCIAMENTO - ING L= 140x60,71 MM	04	
L2	1706387	07119100	07123700	ADESIVO JLG PERICOLO SCHIACCIAMENTO - ING L=177,80x69,85 MM (SUL CESTO)	01	
L4	1702868	07117800	07122400	ADESIVO JLG PERICOLO SCHIACCIAMENTO MANO - ING L= 241,30X25.40 MM_MOD_B (**)	01	
L6	1706386	071190000	07123600	ADESIVO JLG PERICOLO CADUTE - ING L=196,85x76,2 MM	01	
L7	07051100	07116700	07121300	ADESIVO JLG PERICOLO CADUTA - RIPRISTINARE I TAPPI - ING L=196,5x35 MM_MOD_B	01	
L8	07051000	07116600	07121200	ADESIVO JLG ATTENZ.CADUTE - SBLOCCARE SOLO NEI CASI PREVISTI - ING D Ø 60 FORO 4 MM (**)	02	
L9	1706133	07118700	07123300	ADESIVO JLG PERICOLO RIBALTAMENTO - ING L=139,7X68,85 MM_MOD_C	01	
L10	07058600	07117200	07121800	ADESIVO JLG POSIZIONE STABILIZZATORI X700 - ING L=139,7X68,85 MM	01	
L16	1706128	07118600	07123200	ADESIVO JLG PERICOLO FOLGORAZIONE - ING L=120,65x91,50 MM_MOD_E	01	
L19	081081GB	081081FR	081081PT	ADESIVO JLG/ANSI CARICO MAX IN CESTA 2 PERSONE X1000AJ - ING L=196,85x76,2 MM (INGLESE)	01	
L20	1706385	07118900	07123500	ADESIVO JLG SCORRIMENTO SBARRA CHIUSURA CESTO - ING L=184,15X25,4 MM_MOD_C	02	
L21	08069800			ADESIVO JLG ATTENZIONI PROP.65 L=101,6x57,1 MM RIF JLG CODE. 1001231801 C	01	

ADESIVI NON IN LINGUA / DECALS NOT IN LANGUAGE		
CODE	DESCRIPTION	QTY
1701640	ADESIVO JLG LEGGERE IL MANUALE L= 69,85x69,85 MM	02
08347500	ADESIVO STRISCIA BIANCA E ROSSA H100 X L350 MM	02
08347400	ADESIVO STRISCIA BIANCA E ROSSA H100 X L220 MM	02
1704277	DECAL,LANYARD ATTACH	02
07690100	ADESIVO JLG - LOGO JLG PER CESTO COLORE GRIGIO PANTONE 432C L=300x104,2 MM	01
1001125483	ADESIVO JLG VIETATO LAVARE L=63,5X63,5 MM	02



TABELLA PERNI/SPINE (PINS TABLE)

LOCKING SYSTEM
GHIERA
(LOCKNUTS CODE)
REF. TABLE BELOW



PERNO/SPINA (PIN)

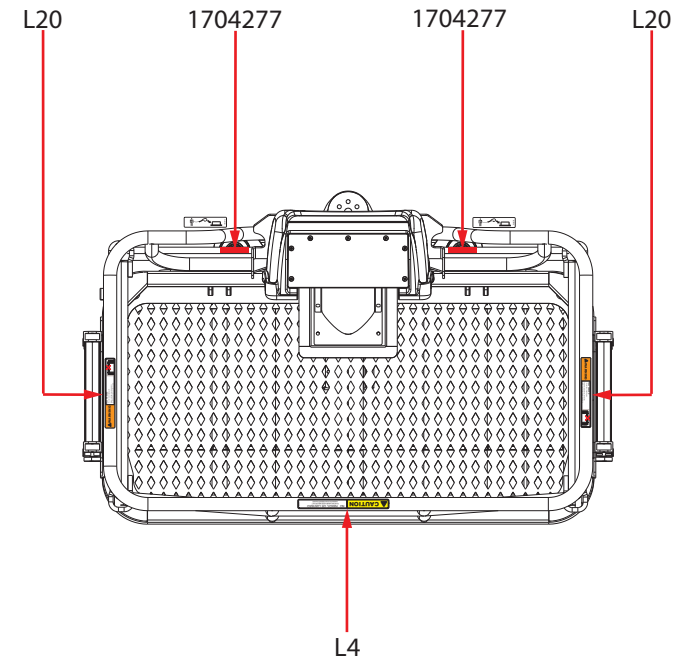
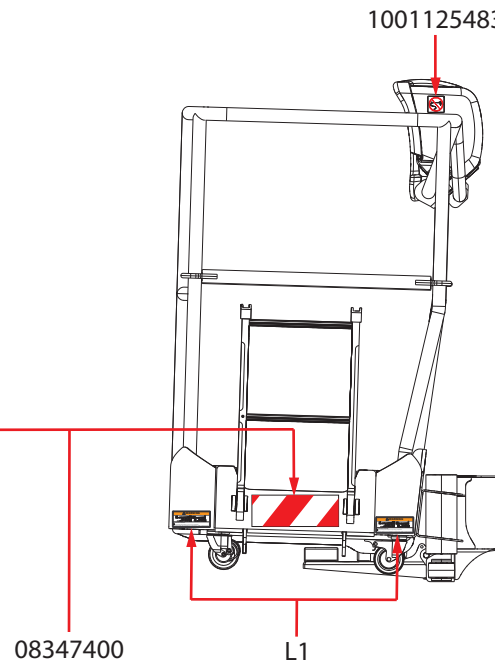
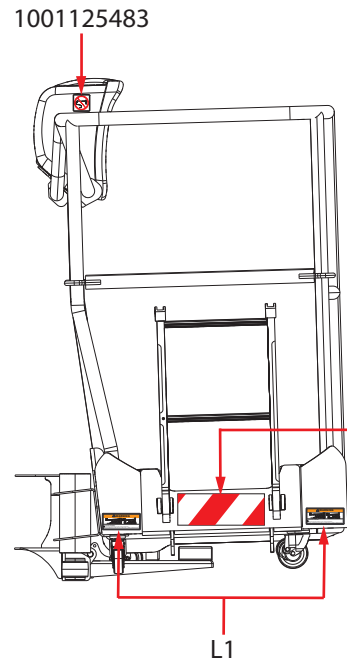
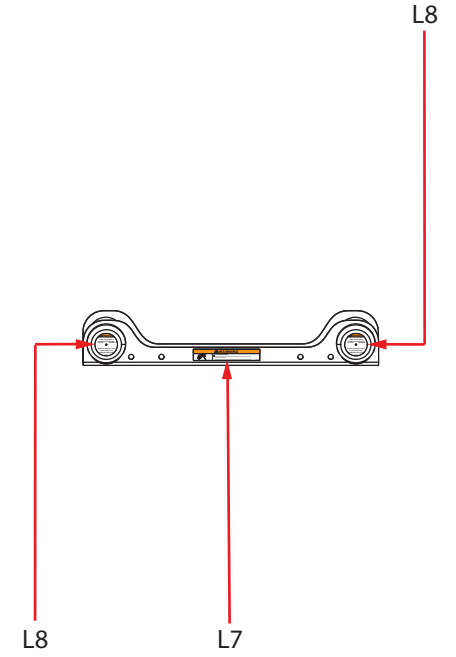
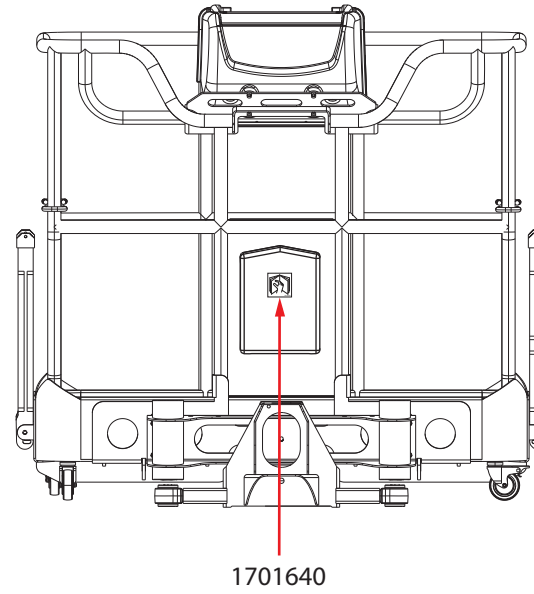
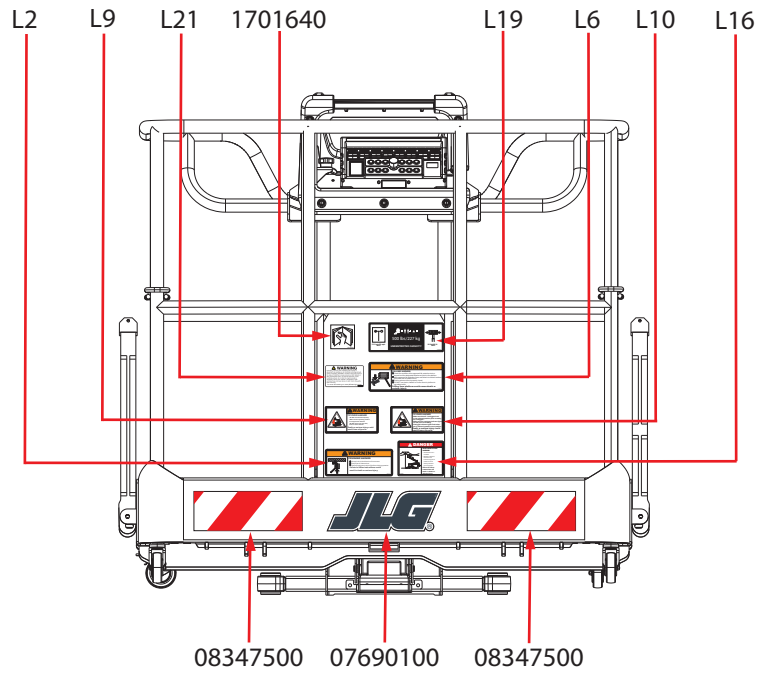
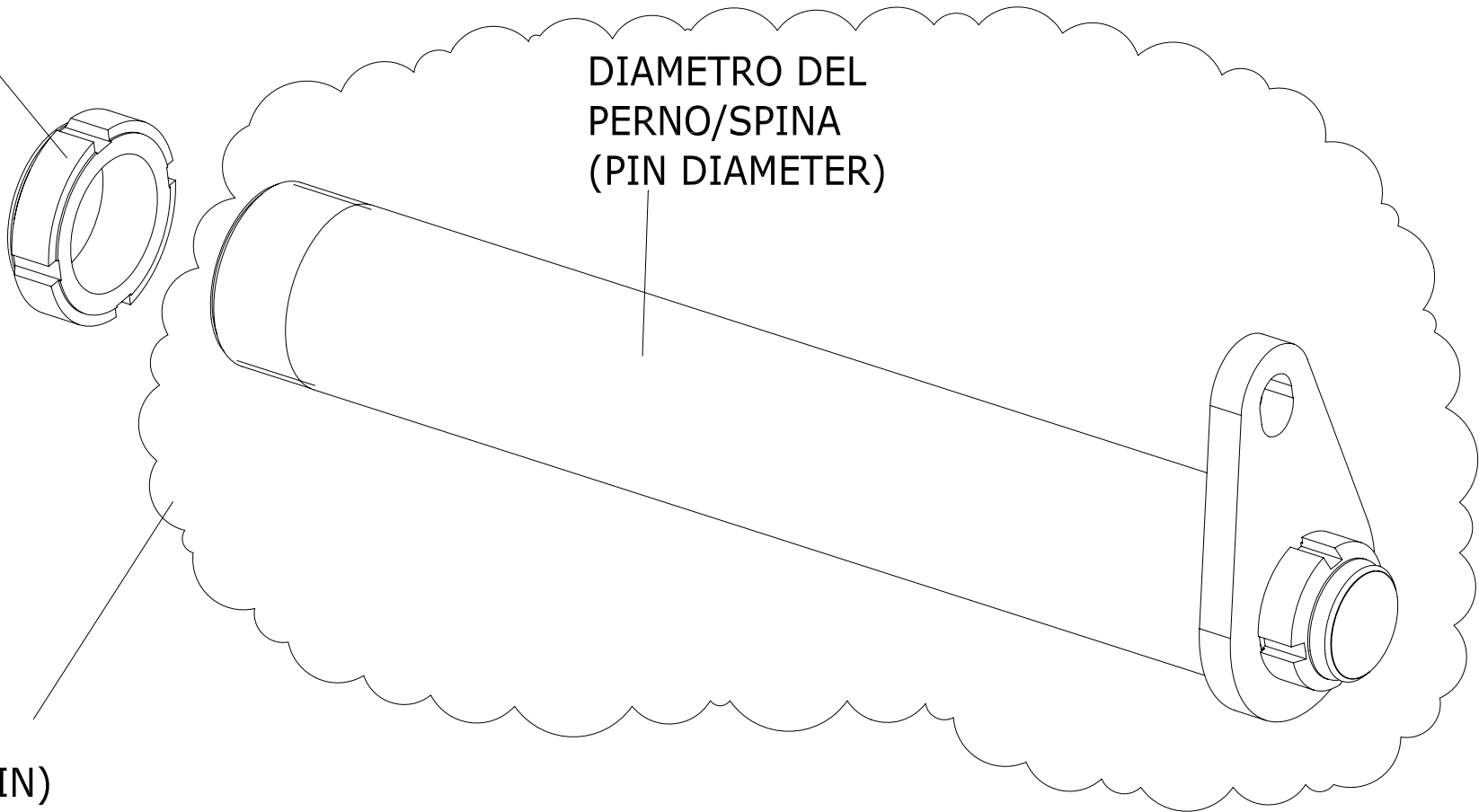



IL CODICE DEL PERNO A RICAMBIO COMPRENDE LA GOCCIA MONTATA E LA GHIERA DI FISSAGGIO DELLA GOCCIA

THE CODE OF A PIN INCLUDES DROP PARTS MOUNTED AND THE LOCK NUT TO FIXING THE DROP, ALL THESE PARTS ARE SHIPPED ALREADY MOUNTED TOGETHER

DIAMETRO DEL PERNO/SPINA mm SISTEMA METRICO (PIN DIAMETER mm METRIC)	GHIERA (LOCKNUTS CODE)	DADO (NUTS CODE)
25	BG4	
30	BG5	
35	BG3	
40	BG2	
45	BG7	
50	BG8	
20 (DIAMETER OF THREADED PART M17 PITCH=1)	BG1	
20 (DIAMETER OF THREADED PART M20 PITCH=1)	BG6	
20 (DIAMETER OF THREADED PART M20 PITCH=1,5)	BG12	

07825700 BUSSOLA PER GHIERE S12GU
 07825800 BUSSOLA PER GHIERE S17GU
 07825900 BUSSOLA PER GHIERE S20GU
 07826000 BUSSOLA PER GHIERE S25GU
 07826100 BUSSOLA PER GHIERE S30GU
 07826200 BUSSOLA PER GHIERE S35GU
 07826300 BUSSOLA PER GHIERE S40GU
 07826400 BUSSOLA PER GHIERE S45GU
 07826500 BUSSOLA PER GHIERE S50GU
 07826600 BUSSOLA PER GHIERE S55GU
 07826700 BUSSOLA PER CHIÈRE S65GU



POS	Codice	U.M.	 Descrizione	 Description	 Designation	 Benennung	 Descripción
BC1	BC000100	NR	COPPIGLIA 4X40	COTTER PIN 4X40	GOUPILLE 4X40	SPLINT 4X40	CLAVIJA 4X40
BC2	BC000200	NR	COPPIGLIA 5X40	COTTER PIN 5X40			
BC3	BC000300	NR	SEEGER ESTERNO Ø20 GEOMET	SEEGER EXTERNAL Ø20 GEOMET	SEGER EXTERNE Ø20 GEOMET	EXTERNEN SEGER Ø20 GEOMET	SEGER ESTERNO Ø20 GEOMET
BC4	BC000400	NR	SEEGER ESTERNO Ø8	SEEGER EXTERNAL Ø8	CIRCLIP	RING	ANILLO
BC5	BC000500	NR	SEEGER ESTERNO Ø25 GEOMET	SEEGER EXTERNAL Ø25 GEOMET	SEEGER CIRCLIP	SEEGERRING	ANILLO DE RETENCIÓN SEEGER
BC6	BC000600	NR	COPPIGLIA 1,8X8	COTTER PIN 1,8X8			
BC7	BC000700	NR	COPPIGLIA 4X55	COTTER PIN 4X55	GOUPILLE 4X55	SPLINT 4X55	CLAVIJA 4X55
BC8	BC000800	NR	SEEGER ESTERNO Ø15	SEEGER EXTERNAL Ø15	CIRCLIP	RING	ANILLO
BC9	BC000900	NR	SEEGER ESTERNO Ø30	SEEGER EXTERNAL Ø30	CIRCLIP	RING	ANILLO
BC11	BC001100	NR	ANELLI ELASTICI X ALBERI (SEEGER) DIN 471 ACC.MOLLE 10 ZINCATA D. BIANCA	SNAP RINGS FOR SHAFTS (SEEGER) DIN 471 ACC. SPRINGS 10 Z WITHE	CIRCLIP	RING	ANILLO
BC12	BC001200	NR	ANELLI ELASTICI X ALBERI (SEEGER) DIN 471 ACC.MOLLE 12 GEO 321A	SNAP RINGS FOR SHAFTS (SEEGER) DIN 471 ACC. SPRINGS 12 GEO 321A	CIRCLIP	RING	ANILLO
BC13	BC001300	NR	ANELLI ELASTICI X FORI (SEEGER) DIN 472 ACC.MOLLE 33 GEO 321A	SNAP RINGS FOR HOLES (SEEGER) DIN 472 ACC. SPRINGS 33 GEO 321A	CIRCLIP	RING	ANILLO
BC14	BC001400	NR	ANELLI ELASTICI X FORI (SEEGER) DIN 472 ACC.MOLLE 62 GEO 321A	SNAP RINGS FOR HOLES (SEEGER) DIN 472 ACC. SPRINGS 62 GEO 321A	CIRCLIP	RING	ANILLO
BC15	BC001500	NR	ANELLI ELASTICI X FORI (SEEGER) DIN 472 ACC.MOLLE 75 GEO 321A	SNAP RINGS FOR HOLES (SEEGER) DIN 472 ACC. SPRINGS 75 GEO 321A	CIRCLIP	RING	ANILLO
BC16	BC001600	NR	COPIGLIA RICOTTA DIN 94 FERRO RICOTTO D 5 X 70 Z.BIANCA	COTTER PIN DIN 94 IRON ANNEALED D 5 X 70 Z. WHITE	CIRCLIP	RING	ANILLO



POS	Codice	U.M.	 Descrizione	 Description	 Designation	 Benennung	 Descripción
BC17	BC001700	NR	COPIGLIA ELASTICA DI SICUREZZA ACC.MOLLE D 2 Z.BIANCA	ELASTIC COTTER PIN ACC. SPRINGS D 2 Z. WHITE	CIRCLIP	RING	ANILLO
BC18	BC001800	NR	ANELLI ELASTICI X ALBERI (SEEGER) DIN 471 ACC.MOLLE 35 GEO 321A	SNAP RINGS FOR SHAFTS (SEEGER) DIN 471 ACC. SPRINGS 35 GEO 321A	CIRCLIP	RING	ANILLO
BC19	BC001900	NR	ANELLI ELASTICI X ALBERI (SEEGER) DIN 471 ACC.MOLLE 70 GEO 321A	SNAP RINGS FOR SHAFTS (SEEGER) DIN 471 ACC. SPRINGS 70 GEO 321A	CIRCLIP	RING	ANILLO
BC20	BC002000	NR	COPIGLIA RICOTTA DIN 94 FERRO RICOTTO D 5 X 50 Z.BIANCA	COTTER PIN DIN 94 IRON ANNEALED D 5 X 50 Z. WHITE	CIRCLIP	RING	ANILLO
BC21	BC002100	NR	ANELLI ELASTICI X FORI (SEEGER) DIN 472 ACC.MOLLE 55 GEO 321A	SNAP RINGS FOR HOLES (SEEGER) DIN 472 ACC. SPRINGS 55 GEO 321A	CIRCLIP	RING	ANILLO
BD1	BD000100	NR	DADO ESAGONALE FLANGIATO LISCIO PG DIN 6923 CL 8 M 14 Z.BIANCA	HEX FLANGE NUT DIN 6923 CL SMOOTH PG 8 M 14 Z. WHITE	ÉCROU HEXAGONAL BRIDÉ LISSE PG DIN 6923 CL 8 M 14 Z.BLANCHE	GEWINDE SECHSKANTMUTTER DIN 6923 CL SMOOTH PG 8 M 14 Z. WEIß	ARANDELA HEXAGONAL ROSCADA LISA DIN 6923 CL 8 M 14 GALVANIZADA BLANCA
BD2	BD000200	NR	DADO ESAGONALE BASSO PG DIN 936 CL 04 M 8 Z.BIANCA	LOW HEX NUT DIN 936 PG 04 M CL 8 Z. WHITE	ÉCROU HEXAGONAL BAS PG DIN 936 CL 04 M 8 GALVANISÉ BLANC	NUTTER	TUERCA
BD3	BD000300	NR	DADO ESAGONALE ALTO PG UNI 5587 CL 8 M 8 Z.BIANCA	HEX NUT HIGH PG UNI 5587 CL 8 M 8 Z. WHITE	ÉCROU HEXAGONAL PG UNI 5587 CL 8 M 8 Z.BLANCHE	HOHE SECHSKANTMUTTER PG UNI 5587 CL 8 M 8 Z. WEIß	ARANDELA ALTA HEXAGONAL UNI 5587 CL 8 M 8 GALVANIZADA BLANCA
BD4	BD000400	NR	DADO ALTO AUTOBLOCCANTE PG DIN 982 CL 8 M 12 Z.BIANCA	HIGH SELF LOCKING NUT DIN 982 PG 12 CL 8 M Z. WHITE	HAUT ÉCROU AUTOBLOQUANT DIN 982 PG 12 CL 8 M Z. BLANCHE	HOHE SELBSTSICHERUNGSMUTTER DIN 982 PG 12 CL 8 M Z. WEIß	ARANDELA ALTA AUTOBLOCANTE DIN 982 CL 8 M 12 GALVANIZADA BLANCA
BD5	BD000500	NR	DADO ALTO AUTOBLOCCANTE PG DIN 982 CL 8 M 8 Z.BIANCA	HIGH SELF LOCKING NUT DIN 982 PG CL 8 M 8 Z. WHITE	HAUT ÉCROU AUTOBLOQUAND DIN 982 PG CL 8 M 8 Z. BLANCHE	HOHE SELBSTSICHERUNGSMUTTER DIN 982 PG CL 8 M 8 Z. WEIß	ARANDELA ALTA AUTOBLOCANTE DIN 982 CL 8 M 8 GALVANIZADA BLANCA
BD6	BD000600	NR	DADO ESAGONALE ALTO PG UNI 5587 CL 8 M 4 Z.BIANCA	HEX NUT HIGH PG UNI 5587 M 4 CL 8 Z. WHITE	ÉCROU HEXAGONAL HAUT PG UNI 5587 CL 8 M 4 GALVANISÉ BLANC	NUTTER	TUERCA





POS	Codice	U.M.	 Descrizione	 Description	 Designation	 Benennung	 Descripción
BD7	BD000700	NR	DADO ESAGONALE BASSO PG DIN 936 CL 04 M 6 Z.BIANCA	LOW HEX NUT DIN 936 PG 6 CL 04 M Z. WHITE	ÉCROU BAS HEXAGONAL DIN 936 PG 6 CL 04 M Z. BLANCHE	NIEDRIGE SECHSKANTMUTTER DIN 936 PG 6 CL 04 M Z. WEIß	ARANDELA BAJA HEXAGONAL DIN 936 CL 04 M 6 GALVANIZADA BLANCA
BD8	BD000800	NR	DADO BASSO AUTOBLOCCANTE PG DIN 985 CL 8 M 6 Z.BIANCA	LOW SELF-LOCKING NUT DIN 985 PG 6 CL 8 M Z. WHITE	ÉCROU BAS AUTOBLOQUANT DIN 985 PG 6 CL 8 M Z. BLANCHE	NIEDRIGE SELBSTSICHERUNGSMUTTER DIN 985 PG 6 CL 8 M Z. WEIß	ARANDELA BAJA AUTOBLOCANTE DIN 985 CL 8 M 6 GALVANIZADA BLANCA
BD9	BD000900	NR	DADO ALTO AUTOBLOCCANTE PG DIN 982 CL 8 M 6 Z.BIANCA	HIGH SELF LOCKING NUT DIN 982 PG CL 8 M6 Z. WHITE	ÉCROU HAUT AUTOBLOQUANT NUT DIN 982 PG CL 8 M6 Z. BLANCHE	SELBSTSICHERUNGSMUTTER DIN 982 PG CL 8 M6 Z. WEIß	TUERCA AUTOBLOCANTE ALTA DIN 982 CL 8 M 6 GALVANIZADA BLANCA
BD10	BD001000	NR	DADO BASSO AUTOBLOCCANTE PG DIN 985 CL 8 M 5 Z.BIANCA	LOW SELF-LOCKING NUT DIN 985 PG CL 8 M5 Z. WHITE	ÉCROU BAS AUTOBLOQUANT PG DIN 985 CL 8 M 5 GALVANISÉ BLANC	NUTTER	TUERCA
BD11	BD001100	NR	DADO ALTO AUTOBLOCCANTE PG DIN 982 CL 8 M 5 Z.BIANCA	HIGH SELF LOCKING NUT DIN 982 PG CL 8 M5 Z. WHITE	ÉCROU HAUT AUTOBLOQUANT PG DIN 982 CL 8 M 5 Z.BLANCHE	SELBSTSICHERUNGSMUTTER DIN 982 PG CL 8 M5 Z. WEIß	TUERCA AUTOBLOCANTE ALTA PG DIN 982 CL 8 M 5 GALVANIZADA BLANCA
BD12	BD001200	NR	DADO ALTO AUTOBLOCCANTE PG DIN 982 CL 8 M 4 Z.BIANCA	HIGH SELF LOCKING NUT DIN 982 PG CL 8 M4 Z. WHITE	ÉCROU HAUT AUTOBLOQUANT PG DIN 982 CL 8 M 4 Z.BLANCHE	SELBSTSICHERUNGSMUTTER DIN 982 PG CL 8 M4 Z. WEIß	TUERCA ALTA AUTOBLOCANTE PG DIN 982 CL 8 M 4 GALVANIZADO BLANCA
BD13	BD001300	NR	DADO ALTO AUTOBLOCCANTE PG DIN 982 CL 8 M 3 Z.BIANCA	HIGH SELF LOCKING NUT DIN 982 PG CL 8 M3 Z. WHITE	ÉCROU HAUT AUTOBLOQUANT PG DIN 982 CL 8 M 3 GALVANISÉ BLANC	NUTTER	TUERCA
BD14	BD001400	NR	DADO ALTO AUTOBLOCCANTE PF DIN 982 CL 8 M 20 X 1,5 Z.BIANCA	HIGH SELF LOCKING NUT DIN 982 PF CL 8 M 20 X 1.5 Z WHITE	ÉCROU HAUT AUTOBLOQUANT PF DIN 982 CL 8 M 20 X 1,5 Z.BLANCHE	SELBSTSICHERUNGSMUTTER DIN 982 PF CL 8 M 20 X 1.5 Z WEIß	TUERCA AUTOBLOCANTE ALTA DIN 982 CL 8 M 20 X 1,5 GALVANIZADA BLANCA
BD15	BD001500	NR	DADO ALTO AUTOBLOCCANTE PG DIN 982 CL 8 M 10 Z.BIANCA	HIGH SELF LOCKING NUT DIN 982 PG CL 8 M10 Z. WHITE	ÉCROU HAUT AUTOBLOQUANT DIN 982 PG CL 8 M10 Z. BLANCHE	SELBSTSICHERUNGSMUTTER DIN 982 PG CL 8 M10 Z. WEIß	TUERCA AUTOBLOCANTE ALTA DIN 982 CL 8 M 10 GALVANIZADA BLANCA
BD16	BD001600	NR	DADO ESAGONALE ALTO PG UNI 5587 CL 8 M 3 Z.BIANCA	HEX NUT HIGH PG UNI 5587 CL 8 M3 Z. WHITE	ÉCROU HEXAGONAL HAUT PG UNI 5587 CL 8 M 3 GALVANISÉ BLANC	NUTTER	TUERCA
BD17	BD001700	NR	DADO BASSO AUTOBLOCCANTE PG DIN 985 CL 8 M 8 Z.BIANCA	LOW SELF-LOCKING NUT DIN 985 PG CL 8 M8 Z. WHITE	ÉCROU BAS AUTOBLOQUANT PG DIN 985 CL 8 M 8 Z.BLANCHE	SELBSTSICHERUNGSMUTTER DIN 985 PG CL 8 M8 Z. WEIß	TUERCA BAJA AUTOBLOCANTE DIN 985 CL 8 M 8 GALVANIZADA BLANCA

POS	Codice	U.M.	 Descrizione	 Description	 Designation	 Benennung	 Descripción
BD18	BD001800	NR	DADO ALTO AUTOBLOCCANTE PG DIN 982 CL 8 M 16 Z.BIANCA	HIGH SELF LOCKING NUT DIN 982 PG CL 8 M16 Z. WHITE	ÉCROU AUTOBLOQUANT PG DIN 982 CL 8 M 16 GALVANISÉ BLANC	NUTTER	TUERCA
BD22	BD002200	NR	DADO ALTO AUTOBLOCCANTE PG DIN 982 CL 8 M 14 Z.BIANCA	HEX FLANGE NUT DIN 982 CL 8 M 14 Z. WHITE	ÉCROU HAUT AUTOBLOQUANT PG DIN 982 CL 8 M 14 Z.BLANCHE	SELBSTSICHERUNGSMUTTER DIN 982 CL 8 M 14 Z. WEIß	TUERCA ALTA AUTOBLOCANTE 982 CL 8 M 14 GALVANIZADA BLANCA
BD23	BD002300	NR	DADO BASSO AUTOBLOCCANTE PG DIN 985 CL 8 M 10 Z.BIANCA	LOW SELF-LOCKING NUT DIN 985 PG CL 8 M 10 Z. WHITE	ÉCROU BAS AUTOBLAQUANT PG DIN 985 CL 8 M 10 GALVANISÉ BLANC	NUTTER	TUERCA
BD24	BD002400	NR	DADO ALTO AUTOBLOCCANTE PG DIN 982 CL 8 M 24 Z.BIANCA	HIGH SELF LOCKING NUT DIN 982 PG CL 8 M24 Z. WHITE	ÉCROU HAUT AUTOBLOQUANT PG DIN 982 CL 8 M 24 GALVANISÉ BLANC	NUTTER	TUERCA
BD25	BD002500	NR	DADO ESAGONALE ALTO PG UNI 5587 CL 8 M 6 Z.BIANCA	HEX NUT HIGH PG UNI 5587 M 6 CL 8 Z. WHITE	ÉCROU HEXAGONAL HAUT PG UNI 5587 CL 8 M 6 Z.BLANCHE	SECHSKANTMUTTER PG UNI 5587 M 6 CL 8 Z. WEIß	TUERCA ALTA HEXAGONAL UNI 5587 CL 8 M 6 GALVANIZADA BLANCA
BD26	BD002600	NR	DADO ESAGONALE ALTO PG UNI 5587 CL 10 M 10 Z.BIANCA	HEX NUT HIGH PG UNI 5587 M 10 CL 10 Z. WHITE	ÉCROU HEXAGONAL HAUT PG UNI 5587 CL 10 M 10 Z.BLANCHE	SECHSKANTMUTTER PG UNI 5587 M 10 CL 10 Z. WEIß	TUERCA ALTA HEXAGONAL UNI 5587 CL 10 M 10 GALVANIZADA BLANCA
BD27	BD002700	NR	DADO ALTO AUTOBLOCCANTE PG DIN 982 CL 8 M 18 Z.BIANCA	HIGH SELF LOCKING NUT DIN 982 PG CL 8 M18 Z. WHITE	ÉCROU HAUT AUTOBLOQUANT PG DIN 982 CL 8 M 18 Z.BLANCHE	SELBSTSICHERUNGSMUTTER DIN 982 PG CL 8 M18 Z. WEIß	TUERCA ALTA AUTOBLOCANTE DIN 982 CL 8 M 18 GALVANIZADA BLANCA
BD28	BD002800	NR	DADO BASSO AUTOBLOCCANTE PG DIN 985 CL 8 M 16 Z.BIANCA	LOW SELF-LOCKING NUT DIN 985 PG CL 8 M 16 Z. WHITE	ÉCROU BAS AUTOBLOQUANT PG DIN 985 CL 8 M 16 GALVANISÉ BLANC	NIEDRIGE SELBSTSICHERUNGSMUTTER DIN 985 PG CL 8 M 16 Z. WEIß	TUERCA BAJA AUTOBLOCANTE PG DIN 985 CL 8 M 16 GALVANIZADA BLANCA
BD29	BD002900	NR	DADO ESAGONALE ALTO PG UNI 5587 CL 8 M 5 Z.BIANCA	HEX NUT HIGH PG UNI 5587 M 5 CL 8 Z. WHITE	ÉCROU HEXAGONAL HAUT PG UNI 5587 CL 8 M 5 Z.BLANCHE	SECHSKANTMUTTER PG UNI 5587 M 5 CL 8 Z. WEIß	TUERCA ALTA HEXAGONAL UNI 5587 CL 8 M 5 GALVANIZADA BLANCA
BD30	BD003000	NR	DADO ESAGONALE ALTO PG UNI 5587 CL 12 M 5 Z.BIANCA	HEX NUT HIGH PG UNI 5587 M 5 CL 12 Z. WHITE	ÉCROU HEXAGONAL HAUT PG UNI 5587 CL 12 M 5 Z.BLANCHE	SECHSKANTMUTTER PG UNI 5587 M 5 CL 12 Z. WEIß	TUERCA ALTA HEXAGONAL UNI 5587 CL 12 M 5 GALVANIZADA BLANCA
BD31	BD003100	NR	DADO ESAGONALE ALTO PG UNI 5587 CL 16 M 5 Z.BIANCA	HEX NUT HIGH PG UNI 5587 M 5 CL 16 Z. WHITE	ÉCROU HEXAGONAL HAUT PG UNI 5587 CL 16 M 5 Z.BLANCHE	SECHSKANTMUTTER PG UNI 5587 M 5 CL 16 Z. WEIß	TUERCA ALTA HEXAGONAL UNI 5587 CL 16 M 5 GALVANIZADA BLANCA

POS	Codice	U.M.	 Descrizione	 Description	 Designation	 Benennung	 Descripción
BD32	BD003200	NR	DADO ALTO AUTOBLOCCANTE PG DIN 982 CL 8 M 20 Z.BIANCA	HIGH SELF LOCKING NUT DIN 982 PG CL 8 M20 Z. WHITE	ÉCROU HAUT AUTOBLOQUANT PG DIN 982 CL 8 M 20 GALVANISÉ BLANC	NUTTER	TUERCA
BD33	BD003300	NR	DADO BASSO AUTOBLOCCANTE PG DIN 985 CL 8 M 12 Z.BIANCA	LOW SELF-LOCKING NUT DIN 985 PG CL 8 M 12 Z. WHITE	ÉCROU BAS AUTOBLAQUANT PG DIN 985 CL 8 M 12 GALVANISÉ BLANC	NUTTER	TUERCA
BD35	BD003500	NR	DADO ESAGONALE ALTO PG UNI 5587 CL 10 M 12 Z.BIANCA	HEXAGON NUT ALTO UNI 5587 CL 10 M 12 Z. WHITE	ÉCROU	NUTTER	TUERCA
BD36	BD003600	NR	DADO ESAGONALE ALTO PG UNI 5587 CL 10 M 16 Z.BIANCA	HEXAGON NUT ALTO UNI 5587 CL 10 M 16 Z. WHITE	ÉCROU	NUTTER	TUERCA
BD37	BD003700	NR	DADO ESAGONALE ALTO PG UNI 5587 CL 8 M 20 Z.BIANCA	HEXAGON NUT ALTO UNI 5587 CL 8 M 20 Z. WHITE	ÉCROU	NUTTER	TUERCA
BD39	BD003900	NR	DADO ALTO AUTOBLOCCANTE PG DIN 982 CL 8 M 22 Z.BIANCA	HIGH SELF-LOCKING NUT DIN 982 CL 8 M 22 Z. WHITE	ÉCROU	NUTTER	TUERCA
BD40	BD004000	NR	DADO BASSO AUTOBLOCCANTE PG DIN 985 CL 8 M 14 Z.BIANCA	LOW SELF-LOCKING NUT DIN 985 CL 8 M 14 Z. WHITE	ÉCROU	NUTTER	TUERCA
BD41	BD004100	NR	DADO ESAGONALE MEDIO PF DIN 934 CL 10 M 16 X 1,5 Z.BIANCA	MEDIUM HEXAGONAL NUT PF DIN 934 CL 10 M 16 X 1.5 Z.BIANCA	ÉCROU HEXAGONAL	NUTTER	TUERCA
BD42	BD004200	NR	DADO ALTO PG DIN 982 CL 8 M 24 Z.BIANCA	HIGH NUT DIN 982 PG CL 8 M24 Z. WHITE	ÉCROU PG DIN 982 CL 8 M 24 GALVANISÉ BLANC	NUTTER	TUERCA
BD45	BD004500	NR	DADO ESAGONALE BASSO MB DIN439 INOX A2 M10 X 1	LOW NUT DIN439 INOX MB M10 X 1	ÉCROU BAS DIN439 INOX MB M10 X 1	NUTTER	TUERCA
BD46	BD004600	NR	DADO ALTO AUTOBLOCCANTE PG DIN 982 INOX A2 M4	NUT PG DIN 982 INOX A2 M4	ÉCROU PG DIN 982 INOX A2 M4	NUTTER	TUERCA
BG1	BG000100	NR	GHIERA AUTOBLOCCANTE GN CL 6 GN 3 D. 17 X 1 Z.BIANCA	SELF-LOCKING NUT GN GN 3 CL 6 D. 17 X 1 Z. WHITE			
BG2	BG000200	NR	GHIERA AUTOBLOCCANTE PESANTE CL 6 GUP 40 X 1,5 Z.BIANCA	SELF-LOCKING NUT HEAVY CL 6 GUP 40 X 1.5 Z WHITE			

POS	Codice	U.M.	 Descrizione	 Description	 Designation	 Benennung	 Descripción
BG3	BG000300	NR	GHIERA AUTOBLOCCANTE PESANTE CL 6 GUP 35 X 1,5 Z.BIANCA	SELF-LOCKING NUT HEAVY CL 6 GUP 35 X 1.5 Z WHITE			
BG4	BG000400	NR	GHIERA AUTOBLOCCANTE PESANTE CL 6 GUP 25 X 1,5 Z.BIANCA	SELF-LOCKING NUT HEAVY CL 6 GUP 25 X 1.5 Z WHITE	ÉCROU AUTO-BLOQUANT	SELBSTSICHERNDE NUTMUTTER	
BG5	BG000500	NR	GHIERA AUTOBLOCCANTE PESANTE CL 6 GUP 30 X 1,5 Z.BIANCA	SELF-LOCKING NUT HEAVY CL 6 GUP 30 X 1.5 Z WHITE	BAGUE AUTOBLOQUANT LOURDE CL 6 GUP 30 X 1,5 Z.BLANCHE	SELBSTSICHERUNGSNUTMUTTER CL 6 GUP 30 X 1.5 Z WEIß	CASQUILLO AUTOBLOCANTE CL 6 GUP 30 X 1,5 GALVANIZADO BLANCO
BG6	BG000600	NR	GHIERA AUTOBLOCCANTE PESANTE CL 6 GUP 20 X 1 Z.BIANCA	SELF-LOCKING NUT HEAVY CL 6 GUP 20 X 1 Z. WHITE	BAGUE AUTOBLOQUANTE CL 6 GUP 20 X 1 Z.BLANCHE	SELBSTSICHERUNGSNUTMUTTER CL 6 GUP 20 X 1 Z. WEIß	CASQUILLO AUTOBLOCANTE CL 6 GUP 20 X 1 GALVANIZADO BLANCO
BG7	BG000700	NR	GHIERA AUTOBLOCCANTE GN CL 6 GN 3 D. 45 X 1,5 Z.BIANCA	NUT	BAGUE	NUTMUTTER	TUERCA
BG8	BG000800	NR	GHIERA AUTOBLOCCANTE GN CL 6 GN 3 D. 50 X 1,5 Z.BIANCA	NUT	BAGUE	NUTMUTTER	TUERCA
BG9	BG000900	NR	GHIERA AUTOBLOCCANTE GN CL 6 GN 3 D. 20 X 1,5 Z.BIANCA	NUT	BAGUE	NUTMUTTER	TUERCA
BG10	BG001000	NR	GHIERA AUTOBLOCCANTE RIBASSATA CL 6 GUK 25 X 1,5 Z.BIANCA	SELF-LOCKING NUT LOWERED CL 6 GUK 25 X 1.5 Z.BIANCA	BAGUE	NUTMUTTER	TUERCA
BG11	BG001100	NR	GHIERA AUTOBLOCCANTE RIBASSATA CL 6 GUK 20 X 1 Z.BIANCA	SELF-LOCKING NUT LOWERED CL 6 GUK 20 X 1 Z.BIANCA	BAGUE	NUTMUTTER	TUERCA
BG12	BG001200	NR	GHIERA AUTOBLOCCANTE RIBASSATA CL 6 GUA 20 X 1.5 Z.BIANCA	SELF-LOCKING NUT LOWERED CL 6 GUA 20 X 1.5 Z.BIANCA	BAGUE	NUTMUTTER	TUERCA
BG13	BG001300	NR	GHIERA AUTOBLOCCANTE RIBASSATA CL 6 GUK 30 X 1.5 Z.BIANCA	SELF-LOCKING NUT LOWERED CL 6 GUK 30 X 1.5 Z.BIANCA	BAGUE	NUTMUTTER	TUERCA
BG14	BG001400	NR	GHIERA AUTOBLOCCANTE RIBASSATA CL 6 GUK 45 X 1.5 Z.BIANCA	SELF-LOCKING NUT LOWERED CL 6 GUK 45 X 1.5 Z.BIANCA	BAGUE	NUTMUTTER	TUERCA

POS	Codice	U.M.	 Descrizione	 Description	 Designation	 Benennung	 Descripción
BG15	BG001500	NR	GHIERA AUTOBLOCCANTE RIBASSATA CL 6 GUK 50 X 1.5 Z.BIANCA	SELF-LOCKING NUT LOWERED CL 6 GUK 50 X 1.5 Z.BIANCA	BAGUE	NUTMUTTER	TUERCA
BG16	BG001600	NR	GHIERA AUTOBLOCCANTE RIBASSATA CL 6 GUK 55 X 2 Z.BIANCA	SELF-LOCKING NUT LOWERED CL 6 GUK 55 X 2 Z.BIANCA	BAGUE	NUTMUTTER	TUERCA
BG17	BG001700	NR	GHIERA AUTOBLOCCANTE GN CL 6 GN 1 D. 12 X 1 Z.BIANCA	SELF-LOCKING NUT GN CL 6 GN 1 D. 12 X 1 Z. WHITE	BAGUE	NUTMUTTER	TUERCA
BG18	BG001800	NR	GHIERA AUTOBLOCCANTE GN CL 6 GN 3 D. 65 X 2 Z.BIANCA	NUT	BAGUE	NUTMUTTER	TUERCA
BI1	BI000100	NR	INSERTO ESAGONALE M6	INSERT HEX M6	INSERT FILETE M9 TETE REDUITE	GEWINDEINSERT M9 REDUZIERTER KOPF	INSERTO ROSCADO M9 CABEZA REDUCIDA
BI2	BI000200	NR	INSERTO ESAGONALE M5	INSERT HEX M5	INSERT FILETE M5 TETE REDUITE	GEWINDEINSERT M5 REDUZIERTER KOPF	INSERTO ROSCADO M5 CABEZA REDUCIDA
BI3	BI000300	NR	INSERTO CILINDRICO M4	INSERT M4			
BI4	BI000400	NR	INSERTO CILINDRICO M6	INSERT M6			
BI5	BI000500	NR	INSERTO ESAGONALE M8	INSERT HEX M8	INSERT FILETE M8 TETE REDUITE	GEWINDEINSERT M8 REDUZIERTER KOPF	INSERTO ROSCADO M8 CABEZA REDUCIDA
BI6	BI000600	NR	INSERTO ESAGONALE M4	INSERT HEX M4	INSERT FILETE M4 TETE REDUITE	GEWINDEINSERT M4 REDUZIERTER KOPF	INSERTO ROSCADO M4 CABEZA REDUCIDA
BI7	BI000700	NR	INSERTO CILINDRICO M8	INSERT M8			
BR1	BR000100	NR	GROWER SEZ.RETT.SPIGOLI VIVI PESANTE UNI 9195 ACC.MOLLE D 6 Z.D.BIANCA	GROWER SEZ.RETT. SHARP HEAVY UNI 9195 ACC.MOLLE D 6 Z.D. WHITE	RONDELLE GROWER SECT.RECT. UNI 9195 ACC.MOLLE D 6 GALVANISÉE BLANCHE	GROWER UNTERLEGSCHIEBE UNI 9195 D 6 Z.D. WEIß	ARANDELA GROWER SEC. RECT. UNI 9195 D 6 GALVANIZADA BLANCA
BR2	BR000200	NR	RONDELLA PIANA DIN 125-A HV100 D 4 Z.BIANCA	PLAIN WASHER DIN 125-A HV100 D 4 Z. WHITE	RONDELLE PLATE DIN 125-A HV100 D 4 Z.BLANCHE	FLACHE UNTERLEGSCHIEBE DIN 125-A HV100 D 4 Z.WEIß	ARANDELA PLANA DIN 125-A HV100 D 4 GALVANIZADA BLANCA
BR3	BR000300	NR	RONDELLA PIANA DIN 125-A HV100 D 5 Z.BIANCA	PLAIN WASHER DIN 125-A HV100 D 5 Z. WHITE	RONDELLE PLATE DIN 125-A HV100 D 5 Z.BLANCHE	FLACHE UNTERLEGSCHIEBE DIN 125-A HV100 D 5 Z.WEIß	ARANDELA PLANA DIN 125-A HV100 D 5 GALVANIZADA BLANCA

POS	Codice	U.M.	 Descrizione	 Description	 Designation	 Benennung	 Descripción
BR4	BR000400	NR	RONDELLA PIANA DIN 125-A HV100 D 6 Z.BIANCA	PLAIN WASHER DIN 125-A HV100 D 6 Z. WHITE	RONDELLE PLATE DIN 125-A HV100 D 6 Z.BLANCHE	FLACHE UNTERLEGSCHIEBE DIN 125-A HV100 D 6 Z. WEIß	ARANDELA PLANA DIN 125-A HV100 D 6 GALVANIZADA BLANCA
BR5	BR000500	NR	RONDELLA PIANA DIN 125-A HV100 D 8 Z.BIANCA	PLAIN WASHER DIN 125-A HV100 D 8 Z. WHITE	RONDELLE PLATE DIN 125-A HV100 D 8 Z.BLANCHE	FLACHE UNTERLEGSCHIEBE DIN 125-A HV100 D 8 Z. WEIß	ARANDELA PLANA DIN 125-A HV100 D 8 GALVANIZADA BLANCA
BR6	BR000600	NR	RONDELLA PIANA DIN 125-A HV100 D 10 Z.BIANCA	PLAIN WASHER DIN 125-A HV100 D 10 Z. WHITE	RONDELLE PLATE DIN 125-A HV100 D 10 Z.BLANCHE	FLACHE UNTERLEGSCHIEBE DIN 125-A HV100 D 10 Z. WEIß	ARANDELA PLANA DIN 125-A HV100 D 10 GALVANIZADA BLANCA
BR7	BR000700	NR	RONDELLA PIANA DIN 125-A HV100 D 12 Z.BIANCA	PLAIN WASHER DIN 125-A HV100 D 12 Z. WHITE	RONDELLE PLATE DIN 125-A HV100 D 12 Z.BLANCHE	FLACHE UNTERLEGSCHIEBE DIN 125-A HV100 D 12 Z. WEIß	ARANDELA PLANA DIN 125-A HV100 D 12 GALVANIZADA BLANCA
BR8	BR000800	NR	ROSETTA PIANA FASCIA LARGA E=3D DIN 9021 HV100 D 10 X 30 X 2,5 Z.BIANCA	WIDE BAND AND FLAT WASHER DIN 9021 HV100 3D = D 10 X 30 X 2.5 Z WHITE	RONDELLE PLATE BANDE LARGE E=3D DIN 9021 HV100 D 10 X 30 X 2,5 Z.BLANCHE	FLACHE UNTERLEGSCHIEBE DIN 9021 HV100 3D = D 10 X 30 X 2.5 Z WEIß	ARANDELA DE BANDA ANCHA DIN 9021 HV100 D 10 X 30 X 2,5 GALVANIZADA BLANCA
BR9	BR000900	NR	ROSETTA PIANA FASCIA LARGA E=3D DIN 9021 HV100 D 12 X 36 X 2,5 Z.BIANCA	WIDE BAND AND FLAT WASHER DIN 9021 HV100 3D = D 12 X 36 X 2.5 Z WHITE	RONDELLE PLATE LARGE BANDE =3D DIN 9021 HV100 D 12 X 36 X 2,5 GALVANISÉE BLANCHE	SCHEIBE	ARANDELA
BR10	BR001000	NR	RONDELLA X CARPENTERIA DIN 6916 HV 300 D 16 Z.BIANCA	CARPENTRY WASHER DIN 6916 HV 300 D 16 Z WHITE	RONDELLE POUR CHARPENTERIE DIN 6916 HV 300 D 16 Z.BLANCHE	ZIMMEREI UNTERLEGSCHIEBE DIN 6916 HV 300 D 16 Z WEIß	ARANDELA DE CARPINTERÍA DIN 6916 HV 300 D 16 GALVANIZADA BLANCA
BR11	BR001100	NR	ROSETTE SPECIALI HV100 D 25 X 51 X 1 Z.BIANCA	SPECIAL WASHERS HV100 D 25 X 51 X 1 Z. WHITE	RONDELLES SPÉCIALES HV100 D 25 X 51 X 1 GALVANISATION BLANCHE	SCHEIBE	ARANDELA
BR13	BR001300	NR	RONDELLA DENTELLATURA ESTERNA DIN 6798-A ACC.MOLLE D 3 Z.D.BIANCA	WASHER EXTERNAL SERRATION DIN 6798-A ACC.MOLLE D 3 ZD WHITE	RONDELLE À DENTURE EXTÉRIEURE DIN 6798-A ACC.MOLLE D 3 Z.D GALVANISATION BLANCHE	SCHEIBE	ARANDELA
BR14	BR001400	NR	ROSETTA PIANA FASCIA LARGA E=3D DIN 9021 HV100 D 5 X 15 X 1,2 Z.BIANCA	WIDE BAND AND FLAT WASHER DIN 9021 HV100 3D = D 5 X 15 X 1.2 Z WHIT	RONDELLE PLATE BANDE LARGE E=3D DIN 9021 HV100 D 5 X 15 X 1,2 Z.BLANCHE	UNTERLEGSCHIEBE DIN 9021 HV100 3D = D 5 X 15 X 1.2 Z WEIß	ARANDELA PLANA CINTA LUNGA DIN 9021 HV100 D 5 X 15 X 1,2 GALVANIZADA BLANCA

POS	Codice	U.M.	 Descrizione	 Description	 Designation	 Benennung	 Descripción
BR15	BR001500	NR	ROSETTA PIANA FASCIA LARGA E=3D DIN 9021 HV100 D 6 X 18 X 1,5 Z.BIANCA	WIDE BAND AND FLAT WASHER DIN 9021 HV100 3D = D 6 X 18 X 1.5 Z WHITE	RONDELLE PLATE BANDE LARGE E=3D DIN 9021 HV100 D 6 X 18 X 1,5 Z.BLANCHE	UNTERLEGSSCHEIBE DIN 9021 HV100 3D = D 6 X 18 X 1.5 Z WEIß	ARANDELA PLANA CINTA LUNGA E=3D DIN 9021 HV100 D 6 X 18 X 1,5 GALVANIZADA BLANCA
BR16	BR001600	NR	ROSETTA PIANA FASCIA LARGA E=3D DIN 9021 HV100 D 8 X 24 X 2 Z.BIANCA	WIDE BAND AND FLAT WASHER DIN 9021 HV100 3D = D 8 X 24 X 2 Z. WHITE	RONDELLE PLATE BANDE LARGE E=3D DIN 9021 HV100 D 8 X 24 X 2 Z.BLANCHE	UNTERLEGSSCHEIBE DIN 9021 HV100 3D = D 8 X 24 X 2 Z. WEIß	ARANDELA PLANA CINTA LUNGA E=3D DIN 9021 HV100 D 8 X 24 X 2 GALVANIZADA BLANCA
BR17	BR001700	NR	ROSETTA PIANA FASCIA LARGA E=3D DIN 9021 HV100 D 4 X 12 X 1 Z.BIANCA	WIDE BAND AND FLAT WASHER DIN 9021 HV100 D = 3D 4 X 12 X 1 Z. WHITE	RONDELLE PLASTE BANDE LARGEDIN 9021 HV100 D 4 X 12 X 1 GALVANISATION BLANCHE	SCHEIBE	ARANDELA
BR18	BR001800	NR	RONDELLA PIANA DIN 125-A NYLON D 4	PLAIN WASHER DIN 125-A NYLON D 4	RONDELLE PLATE DIN 125-A NYLON D 4	SCHEIBE	ARANDELA
BR19	BR001900	NR	RONDELLA PIANA DIN 125-A HV100 D 3 Z.BIANCA	PLAIN WASHER DIN 125-A HV100 D 3 Z. WHITE	RONDELLE PLATE DIN 125-A HV100 D 3 GALVANISATION BLANCHE	SCHEIBE	ARANDELA
BR20	BR002000	NR	RONDELLA PIANA DIN 125-A HV100 D 16 Z.BIANCA	PLAIN WASHER DIN 125-A HV100 D 16 Z. WHITE	RONDELLE PLATE DIN 125-A HV100 D 16 GALVANISATION BLANCHE	SCHEIBE	ARANDELA
BR21	BR002100	NR	ROSETTA PIANA FASCIA LARGA E=3D DIN 9021 HV100 D 16 X 48 X 4 Z.BIANCA	WIDE BAND AND FLAT WASHER DIN 9021 HV100 3D = D 16 X 48 X 4 Z. WHITE	RONDELLE PLATE BANDE LARGE E=3D DIN 9021 HV100 D 16 X 48 X 4 GALVANISÉE BLANCHE	FLACHE UNTERLEGSSCHEIBE DIN 9021 HV100 3D = D 16 X 48 X 4 Z. WEIß	ARANDELA PLANA BANDA ANCHA DIN 9021 HV100 D 16 X 48 X 4 GALVANIZADA BLANCA
BR22	BR002200	NR	GROWER SEZ.RETT.SPIGOLI VIVI PESANTE UNI 9195 ACC.MOLLE D 8 Z.D.BIANCA	GROWER SECTION. RECT. SHARP HEAVY UNI 9195 STAINLESS SPRINGS D 8 Z.D. WHITE	RONDELLE GROWER SECT. RECT. ARÊTES AIGUËS D 8 Z.D. BLANC	GROWER UNTERLEGSSCHEIBE - WEIß	ARANDELA GROWER SECT. RECT. ÁNGULOS VIVOS UNI 9195 GALVANIZADA BLANCA
BR23	BR002300	NR	ROSETTA PIANA FASCIA LARGA E=3D DIN 9021 HV100 D 3 X 12 X 1 Z.BIANCA	WIDE BAND AND FLAT WASHER DIN 9021 HV100 D = 3D 3 X 12 X 1 Z. WHITE	RONDELLE PLATE BANDE LARGE DIN 9021 HV100 D 3 X 12 X 1 GALVANISATION BLANCHE	SCHEIBE	ARANDELA
BR24	BR002400	NR	ROSETTA PIANA FASCIA LARGA E=3D DIN 9021 HV100 D 14 X 42 X 3 Z.BIANCA	WIDE BAND AND FLAT WASHER DIN 9021 HV100 D = 3D 14 X 42 X 3 Z. WHITE	RONDELLE PLATE BANDE LARGE DIN 9021 HV100 D 14 X 42 X 3 GALVANISATION BLANCHE	SCHEIBE	ARANDELA

POS	Codice	U.M.	 Descrizione	 Description	 Designation	 Benennung	 Descripción
BR25	BR002500	NR	GROWER SEZ.RETT.SPIGOLI VIVI PESANTE UNI 9195 ACC.MOLLE D 10 Z.D.BIANCA	GROWER SEZ.RETT. SHARP HEAVY UNI 9195 ACC.MOLLE D 10 Z.D. WHITE	RONDELLE GROWER SECT. RECT. ARÊTES AIGUËS UNI 9195 D 10 Z.D. BLANC	GROWER UNTERLEGSCHIEBE - WEIß	ARANDELA GROWER SECT. RECT. ÁNGULOS VIVOS UNI 9195 GALVANIZADA BLANCA
BR26	BR002600	NR	RONDELLA PIANA DIN 125-A D 30 Z.BIANCA	PLAIN WASHER DIN 125-A D 30 Z. WHITE	RONDELLE PLATE DIN 125-A D 30 GALVANISATION BLANCHE	SCHEIBE	ARANDELA
BR27	BR002700	NR	RONDELLA PIANA DIN 125-A HV100 D 14 Z.BIANCA	PLAIN WASHER DIN 125-A HV100 D 14 Z. WHITE	RONDELLE PLATE DIN 125-A HV100 D 14 Z.BLANCHE	FLACHE UNTERLEGSCHIEBE DIN 125-A HV100 D 14 Z. - WEIß	ARANDELA PLANA DIN 125-A HV100 D 14 GALVANIZADA BLANCA
BR28	BR002800	NR	ROSETTA PIANA FASCIA LARGA D 6 X 24 X 2 Z.BIANCA	WIDE BAND AND FLAT WASHER D 6 X 24 X 2 Z WHITE	RONDELLE PLATE BANDE LARGE D 6 X 24 X 2 Z BLANCHE	UNTERLEGSCHIEBE D 6 X 24 X 2 Z - WEIß	ARANDELA PLANA CINTA LUNGA D 6 X 24 X 2 GALVANIZADA BLANCA
BR29	BR002900	NR	RONDELLA PIANA DIN 125-A HV100 D 18 Z.BIANCA	PLAIN WASHER DIN 125-A HV100 D 18 Z. WHITE	RONDELLE PLATE DIN 125-A HV100 D 18 Z. BLANC	FLACHE UNTERLEGSCHIEBE DIN 125-A HV100 D 18 Z. WEIß	ARANDELA PLANA DIN 125-A HV100 D 18 GALVANIZADA BLANCA
BR30	BR003000	NR	RONDELLA PIANA DIN 125-A HV100 D 20 Z.BIANCA	PLAIN WASHER DIN 125-A HV100 D 20 Z. WHITE	RONDELLE PLATE DIN 125-A HV100 D 20 GALVANISÉE BLANCHE	FLACHE UNTERLEGSCHIEBE DIN 125-A HV100 D 20 Z. WEIß	ARANDELA PLANA DIN 125-A HV100 D 20 GALVANIZADA BLANCA
BR31	BR003100	NR	GROWER SEZ.RETT.SPIGOLI VIVI PESANTE UNI 9195 ACC.MOLLE D 12 Z.D.BIANCA	GROWER SEZ.RETT. SHARP HEAVY UNI 9195 ACC.MOLLE D 12 Z.D. WHITE	RONDELLE GROWER SECT. RECT. ARÊTE AIGUË UNI 9195 ACC.MOLLE D 12 Z.D.BLANC	GROWER UNTERLEGSCHIEBE UNI 9195 ACC.MOLLE D 12 Z.D. WEIß	ARANDELA GROWER SECT. RECT. ÁNGULOS VIVOS UNI 9195 D 12 GALVANIZADA BLANCA
BR32	BR003200	NR	ROSETTE SPECIALI HV100 D 30 X 42 X 0.5 Z.BIANCA	SPECIAL WASHERS HV100 D 30 X 42 X 0.5 Z. WHITE	RONDELLES SPÉCIALES HV100 D 30 X 42 X 0.5 GALVANISATION BLANCHE	SCHEIBE	ARANDELA
BR33	BR003300	NR	ROSETTE SPECIALI HV100 D 30 X 61 X 1 Z.BIANCA	SPECIAL WASHERS HV100 D 30 X 61 X 1 Z. WHITE	RONDELLES SPÉCIALES HV100 D 30 X 61 X 1 GALVANISATION BLANCHE	SCHEIBE	ARANDELA
BR34	BR003400	NR	ROSETTE SPECIALI HV100 D 42 X 52 X 0.2 Z.BIANCA	SPECIAL WASHERS HV100 D 42 X 52 X 0.2 Z. WHITE	RONDELLES SPÉCIALES HV100 D 42 X 52 X 0.2 GALVANISATION BLANCHE	SCHEIBE	ARANDELA
BR35	BR003500	NR	ROSETTE SPECIALI HV100 D 42 X 52 X 0.3 Z.BIANCA	SPECIAL WASHERS HV100 D 42 X 52 X 0.3 Z. WHITE	RONDELLES SPÉCIALES HV100 D 42 X 52 X 0.3 GALVANISATION BLANCHE	SCHEIBE	ARANDELA







Viteria











Fasteners







POS	Codice	U.M.	Descrizione	Description	Designation	Benennung	Descripción
BR36	BR003600	NR	ROSETTE SPECIALI HV100 D 42 X 52 X 1 Z.BIANCA	SPECIAL WASHERS HV100 D 42 X 52 X 1 Z. WHITE	RONDELLES SPÉCIALES HV100 D 42 X 52 X 1 GALVANISATION BLANCHE	SCHEIBE	ARANDELA
BR37	BR003700	NR	ROSETTE SPECIALI HV100 D 42 X 52 X 1.5 Z.BIANCA	SPECIAL WASHERS HV100 D 42 X 52 X 1.5 Z. WHITE	RONDELLES SPÉCIALES HV100 D 42 X 52 X 1.5 GALVANISATION BLANCHE	SCHEIBE	ARANDELA
BR38	BR003800	NR	ROSETTE SPECIALI HV100 D 42 X 52 X 2 Z.BIANCA	SPECIAL WASHERS HV100 D 42 X 52 X 2 Z. WHITE	RONDELLES SPÉCIALES HV100 D 42 X 52 X 2 GALVANISATION BLANCHE	SCHEIBE	ARANDELA
BR39	BR003900	NR	ROSETTA PIANA FASCIA LARGA E=3D DIN 9021 HV100 D 18 X 48 X 4 Z.BIANCA	WIDE BAND AND FLAT WASHER DIN 9021 HV100 3D = D 18 X 48 X 4 Z. WHITE	RONDELLE PLATE BANDE LARGE E=3D DIN 9021 HV100 D 18 X 48 X 4 GALVANISÉE BLANCHE	FLACHE UNTERLEGSCHIEBE DIN 9021 HV100 3D = D 18 X 48 X 4 Z. WEIß	ARANDELA PLANA BANDA ANCHA DIN 9021 HV100 D 18 X 48 X 4 GALVANIZADA BLANCA
BR40	BR004000	NR	ROSETTA SCHNORR ZINCATE D 6	WASHER	RONDELLE	SCHEIBE	ARANDELA
BR41	BR004100	NR	GROWER SEZ.RETT.SPIGOLI VIVI PESANTE UNI 9195 ACC.MOLLE D 14 Z.D.BIANCA	GROWER SEZ.RETT. SHARP HEAVY UNI 9195 ACC.MOLLE D 14 Z.D. WHITE	RONDELLE GROWER SECT. RECT. ARÊTE AIGUË UNI 9195 ACC.MOLLE D 14 Z.D.BLANC	GROWER UNTERLEGSCHIEBE UNI 9195 ACC.MOLLE D 14 Z.D. WEIß	ARANDELA GROWER SECT. RECT. ÁNGULOS VIVOS UNI 9195 D 14 GALVANIZADA BLANCA
BR42	BR004200	NR	RONDELLA X CARPENTERIA DIN 6916 HV 300 D 14 Z.BIANCA	CARPENTRY WASHER DIN 6916 HV 300 D 14 Z WHITE	RONDELLE POUR CHARPENTERIE DIN 6916 HV 300 D 14 Z.BLANCHE	ZIMMEREI UNTERLEGSCHIEBE DIN 6916 HV 300 D 14 Z WEIß	ARANDELA DE CARPINTERÍA DIN 6916 HV 300 D 14 GALVANIZADA BLANCA
BR43	BR004300	NR	RONDELLA X CARPENTERIA DIN 125-A HV 300 D 10 Z.BIANCA	CARPENTRY WASHER DIN 125-A HV 300 D 10 Z WHITE	RONDELLE POUR CHARPENTERIE DIN 125-A HV 300 D 10 Z.BLANCHE	ZIMMEREI UNTERLEGSCHIEBE DIN 125-A HV 300 D 10 Z WEIß	ARANDELA DE CARPINTERÍA DIN 125-A HV 300 D 10 GALVANIZADA BLANCA
BR44	BR004400	NR	RONDELLA X CARPENTERIA DIN 125-A HV 300 D 20 Z.BIANCA	CARPENTRY WASHER DIN 125-A HV 300 D 20 Z WHITE	RONDELLE POUR CHARPENTERIE DIN 125-A HV 300 D 20 Z.BLANCHE	ZIMMEREI UNTERLEGSCHIEBE DIN 125-A HV 300 D 20 Z WEIß	ARANDELA DE CARPINTERÍA DIN 125-A HV 300 D 20 GALVANIZADA BLANCA
BR45	BR004500	NR	RONDELLA PIANA DIN 125-A HV200 D 10 Z.BIANCA	PLAIN WASHER DIN 125-A HV200 D 10 Z. WHITE	RONDELLE POUR CHARPENTERIE	ZIMMEREI UNTERLEGSCHIEBE	ARANDELA DE CARPINTERÍA
BR48	BR004800	NR	RONDELLA PIANA DIN 125-A HV100 D 22 Z.BIANCA	PLAIN WASHER DIN 125-A HV100 D 22 Z. WHITE	RONDELLE POUR CHARPENTERIE	ZIMMEREI UNTERLEGSCHIEBE	ARANDELA DE CARPINTERÍA





POS	Codice	U.M.	 Descrizione	 Description	 Designation	 Benennung	 Descripción
BR49	BR004900	NR	ROSETTA PIANA FASCIA LARGA E=4D DIN 9021 HV100 D 12 X 48 X 2,5 Z.BIANCA	WASHER FLAT AND WIDE BAND E = 4D DIN 9021 HV100 D 12 X 48 X 2.5 Z. WHITE	RONDELLE POUR CHARPENTERIE	ZIMMEREI UNTERLEGSCHIEBE	ARANDELA DE CARPINTERÍA
BR50	BR005000	NR	ROSETTA PIANA FASCIA LARGA E=3D DIN 9021 HV100 D 20 X 60 X 4 Z.BIANCA	WASHER FLAT AND WIDE BAND E = 3D DIN 9021 HV100 D 20 X 60 X 4 Z. WHITE	RONDELLE POUR CHARPENTERIE	ZIMMEREI UNTERLEGSCHIEBE	ARANDELA DE CARPINTERÍA
BR53	BR005300	NR	RONDELLE ELASTICHE GROWER DIN 127-B ACC.MOLLE D 6 Z.D.BIANCA	ELASTIC WASHERS GROWER DIN 127-B ACC. SPRINGS D 6 Z.D. WHITE	RONDELLE POUR CHARPENTERIE	ZIMMEREI UNTERLEGSCHIEBE	ARANDELA DE CARPINTERÍA
BR54	BR005400	NR	ROSETTA DI SICUREZZA TIPO SCHNORR TIPO S INOX D 6	WASHER SCHNORR TYPE S INOX D 6 SECURITY	RONDELLE POUR CHARPENTERIE	ZIMMEREI UNTERLEGSCHIEBE	ARANDELA DE CARPINTERÍA
BR55	BR005500	NR	RONDELLA DENTELLATURA ESTERNA DIN 6798-A ACC.MOLLE D 5 Z.D.BIANCA	WASHER EXTERNAL SERRATION DIN 6798-A ACC. SPRINGS D 5 Z.D. WHITE	RONDELLE POUR CHARPENTERIE	ZIMMEREI UNTERLEGSCHIEBE	ARANDELA DE CARPINTERÍA
BR56	BR005600	NR	RONDELLA X CARPENTERIA DIN 6916 HV 300 D 12 Z.BIANCA	WASHER DIN 6916 HV 300 D 12 Z. WHITE	RONDELLE POUR CHARPENTERIE	ZIMMEREI UNTERLEGSCHIEBE	ARANDELA DE CARPINTERÍA
BR57	BR005700	NR	ROSETTE SPECIALI HV100 D 36 X 65 X 1 Z.BIANCA	SPECIAL WASHERS HV100 D 36 X 65 X 1 Z. WHITE	RONDELLES SPÉCIALES HV100 D 36 X 65 X 1 GALVANISATION BLANCHE	SCHEIBE	ARANDELA
BR58	BR005800	NR	ROSETTE SPECIALI HV100 D 50 X 60 X 1 Z.BIANCA	SPECIAL WASHERS HV100 D 50 X 60 X 1 Z. WHITE	RONDELLES SPÉCIALES HV100 D 50 X 60 X 1 GALVANISATION BLANCHE	SCHEIBE	ARANDELA
BR59	BR005900	NR	ROSETTE SPECIALI HV300 D 20 X 54 X 3 Z.BIANCA	SPECIAL WASHERS HV300 D 20 X 54 X 3 Z. WHITE	RONDELLES SPÉCIALES HV300 D 20 X 54 X 3 GALVANISATION BLANCHE	SCHEIBE HV300 D 20 X 54 X 3	ARANDELA HV300 D 20 X 54 X 3 Z.
BR60	BR006000	NR	RONDELLA PIANA DIN 125-A NYLON D 12	PLAIN WASHER DIN 125-A NYLON D 12	RONDELLE PLATE DIN 125-A NYLON D 12	SCHEIBE	ARANDELA
BR61	BR006100	NR	RONDELLA PIANA DIN 125-A INOX A2 D4	PLAIN WASHER DIN 125-A INOX A2 D4	RONDELLE POUR CHARPENTERIE	ZIMMEREI UNTERLEGSCHIEBE	ARANDELA DE CARPINTERÍA
BR62	BR006200	NR	RONDELLA PIANA DIN 125-A HV300 D 20 Z.BIANCA	PLAIN WASHER DIN 125-A HV300 D 20 Z. WHITE	RONDELLE POUR CHARPENTERIE	ZIMMEREI UNTERLEGSCHIEBE	ARANDELA DE CARPINTERÍA
BR63	BR006300	NR	RONDELLA ANTIROTAZIONE DIN463 HV100 D6.4 X M6	WASHER DIN463 HV100 D6.4 X M6	RONDELLE POUR CHARPENTERIE	ZIMMEREI UNTERLEGSCHIEBE	ARANDELA DE CARPINTERÍA

POS	Codice	U.M.	 Descrizione	 Description	 Designation	 Benennung	 Descripción
BS1	BS000100	NR	GRANO FILETTATO M6X12	SCREW	VIS	SCHRAUBE	TORNILLO
BS2	BS000200	NR	SPINA CIL. 8X16 UNI 6364-A H6 CMT + TMP	PIN CYLINDER 8 X 16 UNI 6364-A CMT H6 + TMP			
BS3	BS000300	NR	PRIGIONIERO M10X35	PIN	AXE	GEWINDESTIFT	CLAVIJA
BS4	BS000400	NR	SPINA ELASTICA 6X60 UNI 6873	PIN	AXE	STIFT	CLAVIJA
BS5	BS000500	NR	SPINA ELASTICA 6X14 UNI 6873	PIN	AXE	STIFT	CLAVIJA
BS6	BS000600	NR	SPINA SPIROL NORMALE DIN 7343 INOX A2 D 5X10	PIN	AXE	STIFT	CLAVIJA
BS7	BS000700	NR	RIVETTO ALLUMINIO Ø3X12	ALUMINUM RIVET Ø3X12			
BS8	BS000800	NR	MOLLA COMPRESSIONE INOX AISI 302 D10.668 S1.066 L31.75	SPRING COMPRESSION AISI 302 D10.668 S1.066 L31.75			
BS13	BS001300	NR	SPINA ELASTICA DIN 1481 ACC.MOLLE D 8 X 50	ELASTIC PIN DIN 1481 ACC SPRINGS D 8 X 50			
BS14	BS001400	NR	SPINA SPIROL NORMALE DIN 7343 ACC.MOLLE D 5 X 10	PIN SPIROL NORMAL DIN 7343 ACC. SPRINGS D 5 X 10			
BS15	BS001500	NR	RIVETTI A STRAPPO TB AL/AC DIN 7337 D 3,2 X 12	BLIND RIVETS TB AL / AC DIN 7337 D 3.2 X 12			
BS16	BS001600	NR	RIVETTI A STRAPPO TB AL/AC DIN 7337 D 4,8 X 12	BLIND RIVETS TB AL / AC DIN 7337 D 4.8 X 12			
BS17	BS001700	NR	RIVETTI A STRAPPO TB A2/A2 DIN 7337 D 4,8 X 12	BLIND RIVETS TB A2 / A2 DIN 7337 D 4.8 X 12			
BS21	BS002100	NR	RIVETTO ALLUMINIO Ø4X10	ALUMINUM RIVET Ø4X10			
BS22	BS002200	NR	PRIGIONIERO M10X80	PIN M10X80	AXE M10X80	GEWINDESTIFT M10X80	CLAVIJA M10X80
BV1	BV000100	NR	VITE TE PARZIALE FILETTO PG DIN 931 CL 8.8 M 8 X 80 Z.BIANCA	SCREW PARTIAL THREAD DIN 931 PG CL 8.8 M 8 X 80 Z. WHITE	VIS PARTIELLEMENT FILETÉE DIN 931 CL 8.8 M 8 X 80 GALVANISATION BLANCHE	SCHRAUBE	TORNILLO
BV2	BV000200	NR	VITE TE TUTTO FILETTO PG DIN 933 CL 8.8 M 8 X 60 Z.BIANCA	SCREW ALL THREAD DIN 933 PG CL 8.8 M 8 X 60 Z. WHITE	VIS ENTIÈREMENT FILETÉE DIN 933 CL 8.8 M 8 X 60 GALVANISATION BLANCHE	SCHRAUBE	TORNILLO

POS	Codice	U.M.	 Descrizione	 Description	 Designation	 Benennung	 Descripción
BV3	BV000300	NR	VITE TCEI PG DIN 912 CL 8.8 M 8 X 60 Z.BIANCA	SCREW DIN 912 PG CL 8.8 M8 X 60 Z. WHITE	VIS DIN 912 CL 8.8 M 8 X 60 GALVANISATION BLANCHE	SCHRAUBE	TORNILLO
BV4	BV000400	NR	VITE TE PARZIALE FILETTO PG DIN 931 CL 8.8 M 8 X 50 Z.BIANCA	SCREW PARTIAL THREAD DIN 931 PG CL 8.8 M 8 X 50 Z. WHITE	VIS PARTIELLEMENT FILETÉE BLANC	TEILGEWINDESCHRAUBE DIN 931 PG CL 8.8 M 8 X 50 Z. WEIß	TORNILLO PARCIALMENTE ROSCADO PG DIN 931 CL 8.8 M 8 X 50 GALVANIZADO BLANCO
BV5	BV000500	NR	VITE TCEI PG DIN 912 CL 8.8 M 8 X 45 Z.BIANCA	SCREW DIN 912 PG CL 8.8 M8 X 45 Z. WHITE	VIS DIN 912 CL 8.8 M 8 X 45 GALVANISATION BLANCHE	SCHRAUBE	TORNILLOL
BV6	BV000600	NR	VITE TCEI PG DIN 912 CL 8.8 M 8 X 40 Z.BIANCA	SCREW DIN 912 PG CL 8.8 M8 X 40 Z.BIANCA	VIS DIN 912 CL 8.8 M 8 X 40 GALVANISATION BLANCHE	SCHRAUBE	TORNILLO
BV7	BV000700	NR	VITE TE TUTTO FILETTO PG DIN 933 CL 8.8 M 8 X 35 Z.BIANCA	SCREW ALL THREAD DIN 933 PG CL 8.8 M 8 X 35 Z. WHITE	VIS TE ENTIÈREMENT FILETÉE DIN 933 PG CL 8.8 M 8 X 35 Z. BLANC	VOLLGEWINDESCHRAUBE DIN 933 PG CL 8.8 M 8 X 35 Z. WEIß	TORNILLO TOTALMENTE ROSCADO PG DIN 933 CL 8.8 M 8 X 35 GALVANIZADO BLANCO
BV8	BV000800	NR	VITE TE TUTTO FILETTO PG DIN 933 CL 8.8 M 8 X 30 Z.BIANCA	SCREW ALL THREAD DIN 933 PG CL 8.8 M 8 X 30 Z. WHITE	VIS TE ENTIÈREMENT FILETÉE DIN 933 PG CL 8.8 M 8 X 30 Z. BLANC	VOLLGEWINDESCHRAUBE DIN 933 PG CL 8.8 M 8 X 30 Z. WEIß	TORNILLO TOTALMENTE ROSCADO PG DIN 933 CL 8.8 M 8 X 30 GALVANIZADO BLANCO
BV9	BV000900	NR	VITE TE TUTTO FILETTO PG DIN 933 CL 8.8 M 8 X 25 Z.BIANCA	SCREW ALL THREAD DIN 933 PG CL 8.8 M 8 X 25 Z. WHITE	VIS TE ENTIÈREMENT FILETÉE PG DIN 933 CL 8.8 M 8 X 25 Z.BLANC	VOLLGEWINDESCHRAUBE DIN 933 PG CL 8.8 M 8 X 25 Z. WEIß	TORNILLO TOTALMENTE ROSCADO PG DIN 933 CL 8.8 M 8 X 25 GALVANIZADO BLANCO
BV10	BV001000	NR	VITE TCEI PG DIN 912 CL 8.8 M 8 X 25 Z.BIANCA	SCREW DIN 912 PG CL 8.8 M8 X 25 Z. WHITE	VIS TCEI PG DIN 912 CL 8.8 M 8 X 25 Z.BLANC	SCHRAUBE DIN 912 PG CL 8.8 M8 X 25 Z. WEIß	TORNILLO TCEI PG DIN 912 CL 8.8 M 8 X 25 GALVANIZADO BLANCO
BV11	BV001100	NR	VITE TE TUTTO FILETTO PG DIN 933 CL 8.8 M 8 X 20 Z.BIANCA	SCREW ALL THREAD DIN 933 PG CL 8.8 M 8 X 20 Z. WHITE	VIS TE ENTIÈREMENT FILETÉE PG DIN 933 CL 8.8 M 8 X 20 Z.BLANC	VOLLGEWINDESCHRAUBE DIN 933 PG CL 8.8 M 8 X 20 Z. WEIß	TORNILLO TOTALMENTE ROSCADO PG DIN 933 CL 8.8 M 8 X 20 GALVANIZADO BLANCO
BV12	BV001200	NR	VITE TE TUTTO FILETTO PG DIN 933 CL 8.8 M 8 X 16 Z.BIANCA	SCREW ALL THREAD DIN 933 PG CL 8.8 M 8 X 16 Z. WHITE	VIS TE ENTIÈREMENT FILETÉE PG DIN 933 CL 8.8 M 8 X 16 Z.BLANC	VOLLGEWINDESCHREUBE DIN 933 PG CL 8.8 M 8 X 16 Z. WEIß	TORNILLO TOTALMENTE ROSCADO PG DIN 933 CL 8.8 M 8 X 16 GALVANIZADO BLANCO
BV13	BV001300	NR	VITE TCEI PG DIN 912 CL 8.8 M 8 X 16 Z.BIANCA	SCREW DIN 912 PG CL 8.8 M8 X 16 Z. WHITE	VIS TCEI PG DIN 912 CL 8.8 M 8 X 16 GALVANISÉE BLANCHE	SCHRAUBE DIN 912 PG CL 8.8 M8 X 16 Z. WEIß	TORNILLO DIN 912 CL 8.8 M 8 X 16 GALVANIZADO BLANCO
BV14	BV001400	NR	VITE TE TUTTO FILETTO PG DIN 933 CL 8.8 M 8 X 14 Z.BIANCA	SCREW ALL THREAD DIN 933 PG CL 8.8 M 8 X 14 Z. WHITE	VIS ENTIÈREMENT FILETÉE DIN 933 CL 8.8 M 8 X 14 GALVANISATION BLANCHE	SCHRAUBE	TORNILLO



POS	Codice	U.M.	 Descrizione	 Description	 Designation	 Benennung	 Descripción
BV15	BV001500	NR	VITE TCEI PG DIN 912 CL 8.8 M 6 X 45 Z.BIANCA	SCREW DIN 912 M6 X 45 CL 8.8 Z. WHITE	VIS DIN 912 CL 8.8 M 6 X 45 GALVANISATION BLANCHE	SCHRAUBE	TORNILLO
BV16	BV001600	NR	VITE TCEI PG DIN 912 CL 8.8 M 6 X 30 Z.BIANCA	SCREW DIN 912 M6 X 30 CL 8.8 Z. WHITE	VIS TCEI PG DIN 912 CL 8.8 M 6 X 30 Z.BLANC	SCHRAUBE DIN 912 M6 X 30 CL 8.8 Z. WEIß	TORNILLO TCEI PG DIN 912 CL 8.8 M 6 X 30 GALVANIZADO BLANCO
BV17	BV001700	NR	VITE TSPEI PG DIN 7991 CL 10.9 M 6 X 30 Z.BIANCA	SCREW DIN 7991 CL 10.9 M 6 X 30 Z. WHITE	VIS DIN 7991 CL 10.9 M 6 X 30 GALVANISATION BLANCHE	SCHRAUBE	TORNILLO
BV18	BV001800	NR	VITE TE TUTTO FILETTO PG DIN 933 CL 8.8 M 6 X 30 Z.BIANCA	SCREW ALL THREAD DIN 933 PG CL 8.8 M 6 X 30 Z. WHITE	VIS ENTIÈREMENT FILETÉE DIN 933 CL 8.8 M 6 X 30 GALVANISÉE BLANCHE	VOLLGEWINDESCHRAUBE DIN 933 PG CL 8.8 M 6 X 30 Z. WEIß	TORNILLO TOTALMENTE ROSCADO DIN 933 CL 8.8 M 6 X 30 GALVANIZADO BLANCO
BV19	BV001900	NR	VITE TBEI PG ISO 7380 CL 10.9 M 6 X 30 Z.BIANCA	SCREW ISO 7380 CL 10.9 M 6 X 30 Z. WHITE	VIS ISO 7380 CL 10.9 M 6 X 30 GALVANISATION BLANCHE	SCHRAUBE	TORNILLO
BV20	BV002000	NR	VITE TE TUTTO FILETTO PG DIN 933 CL 8.8 M 6 X 12 Z.BIANCA	SCREW ALL THREAD DIN 933 PG CL 8.8 M 6 X 12 Z. WHITE	VIS TE ENTIÈREMENT FILETÉE PG DIN 933 CL 8.8 M 6 X 12 Z.BIANCA	VOLLGEWINDESCHRAUBE DIN 933 PG CL 8.8 M 6 X 12 Z. WEIß	TORNILLO TOTALMENTE ROSCADO PG DIN 933 CL 8.8 M 6 X 12 GALVANIZADO BLANCO
BV21	BV002100	NR	VITE TCEI PG DIN 912 CL 8.8 M 6 X 12 Z.BIANCA	SCREW DIN 912 PG CL 8.8 M 6 X 12 Z. WHITE	VIS DIN 912 CL 8.8 M 6 X 12 GALVANISATION BLANCHE	SCHRAUBE	TORNILLO
BV22	BV002200	NR	VITE TCEI PG DIN 912 CL 8.8 M 5 X 45 Z.BIANCA	SCREW DIN 912 PG CL 8.8 M 5 X 45 Z. WHITE	VIS DIN 912 CL 8.8 M 5 X 45 GALVANISATION BLANCHE	SCHRAUBE	TORNILLO
BV23	BV002300	NR	VITE TE UNF ANSI B18.2.1 GR.5 5/16 X 1" Z.BIANCA	SCREW UNF ANSI B18.2.1 GR.5 5/16 X 1" Z. WHITE	VIS UNF ANSI B18.2.1 GR.5 5/16 X 1" GALVANISATION BLANCHE	SCHRAUBE	TORNILLO
BV24	BV002400	NR	VITE TC CROCE PG DIN 7985 CL 4.8 M 4 X 8 Z.BIANCA	CROSS HEAD SCREW DIN 7985 PG CL 4.8 M 4 X 8 Z. WHITE	VIS TC EN CROIX PG DIN 7985 CL 4.8 M 4 X 8 Z.BLANC	KREUZSCHLITZCHRAUBE DIN 7985 PG CL 4.8 M 4 X 8 Z. WEIß	TORNILLO TC DE CRUZ PG DIN 7985 CL 4.8 M 4 X 8 GALVANIZADO BLANCO
BV25	BV002500	NR	VITE TCEI PG DIN 912 CL 8.8 M 4 X 16 Z.BIANCA	SCREW DIN 912 PG CL 8.8 M 4 X 16 Z. WHITE	VIS DIN 912 CL 8.8 M 4 X 16 GALVANISATION BLANCHE	SCHRAUBE	TORNILLO
BV26	BV002600	NR	VITE TCEI PG DIN 912 CL 8.8 M 6 X 50 Z.BIANCA	SCREW DIN 912 PG CL 8.8 M 6 X 50 Z. WHITE	VIS DIN 912 CL 8.8 M 6 X 50 GALVANISATION BLANCHE	SCHRAUBE	TORNILLO
BV27	BV002700	NR	VITE TSPEI PG DIN 7991 CL 10.9 M 6 X 40 Z.BIANCA	SCREW DIN 7991 CL 10.9 M 6 X 40 Z. WHITE	VIS DIN 7991 CL 10.9 M 6 X 40 GALVANISÉE BLANCHE	SCHRAUBE DIN 7991 CL 10.9 M 6 X 40 Z. WEIß	TORNILLO DIN 7991 CL 10.9 M 6 X 40 GALVANIZADO BLANCO





POS	Codice	U.M.	 Descrizione	 Description	 Designation	 Benennung	 Descripción
BV28	BV002800	NR	VITE TSPEI PG DIN 7991 CL 10.9 M 6 X 25 Z.BIANCA	SCREW DIN 7991 CL 10.9 M 6 X 25 Z. WHITE	VIS TSPEI PG DIN 7991 CL 10.9 M 6 X 25 Z.BLANC	SCHRAUBE DIN 7991 CL 10.9 M 6 X 25 Z. WEIß	TORNILLO TSPEI PG DIN 7991 CL 10.9 M 6 X 25 GALVANIZADO BLANCO
BV29	BV002900	NR	VITE TE TUTTO FILETTO PG DIN 933 CL 8.8 M 6 X 25 Z.BIANCA	SCREW ALL THREAD DIN 933 PG CL 8.8 M 6 X 25 Z. WHITE	VIS TE ENTIÈREMENT FILETÉE PG DIN 933 CL 8.8 M 6 X 25 Z.BLANC	VOLLGEWINDESCHRAUBE DIN 933 PG CL 8.8 M 6 X 25 Z. WEIß	TORNILLO TOTALMENTE ROSCADO PG DIN 933 CL 8.8 M 6 X 25 GALVANIZADO BLANCO
BV30	BV003000	NR	VITE TE TUTTO FILETTO PG DIN 933 CL 8.8 M 6 X 22 Z.BIANCA	SCREW ALL THREAD DIN 933 PG CL 8.8 M 6 X 22 Z. WHITE	VIS TE ENTIÈREMENT FILETÉE PG DIN 933 CL 8.8 M 6 X 22 Z.BLANC	VOLLGEWINDESCHRAUBE DIN 933 PG CL 8.8 M 6 X 22 Z. WEIß	TORNILLO TE TOTALMENTE ROSCADO PG DIN 933 CL 8.8 M 6 X 22 GALVANIZADO BLANCO
BV31	BV003100	NR	VITE TSPEI PG DIN 7991 CL 10.9 M 6 X 20 Z.BIANCA	SCREW DIN 7991 CL 10.9 M 6 X 20 Z. WHITE	VIS TSPEI PG DIN 7991 CL 10.9 M 6 X 20 Z.BLANC	SCHRAUBE DIN 7991 CL 10.9 M 6 X 20 Z. WEIß	TORNILLO TSPEI PG DIN 7991 CL 10.9 M 6 X 20 GALVANIZADO BLANCO
BV32	BV003200	NR	VITE TE TUTTO FILETTO PG DIN 933 CL 8.8 M 6 X 20 Z.BIANCA	SCREW ALL THREAD DIN 933 PG CL 8.8 M 6 X 20 Z. WHITE	VIS TE ENTIÈREMENT FILETÉE PG DIN 933 CL 8.8 M 6 X 20 Z.BLANC	VOLLGEWINDESCHRAUBE DIN 933 PG CL 8.8 M 6 X 20 Z. WEIß	TORNILLO TOTALMENTE ROSCADO PG DIN 933 CL 8.8 M 6 X 20 GALVANIZADO BLANCO
BV33	BV003300	NR	VITE TCEI PG DIN 912 CL 8.8 M 6 X 20 Z.BIANCA	SCREW DIN 912 PG CL 8.8 M 6 X 20 Z. WHITE	VIS TCEI PG DIN 912 CL 8.8 M 6 X 20 Z.BLANC	SCHRAUBE DIN 912 PG CL 8.8 M 6 X 20 Z. WEIß	TORNILLO TCEI PG DIN 912 CL 8.8 M 6 X 20 GALVANIZADO BLANCO
BV34	BV003400	NR	VITE TE TUTTO FILETTO PG DIN 933 CL 8.8 M 6 X 16 Z.BIANCA	SCREW ALL THREAD DIN 933 PG CL 8.8 M 6 X 16 Z. WHITE	VIS TE ENTIÈREMENT FILETÉE G DIN 933 CL 8.8 M 6 X 16 Z.BLANC	VOLLGEWINDESCHRAUBE DIN 933 PG CL 8.8 M 6 X 16 Z. WEIß	TORNILLO TOTALMENTE ROSCADO PG DIN 933 CL 8.8 M 6 X 16 GALVANIZADO BLANCO
BV35	BV003500	NR	VITE TBEI PG ISO 7380 CL 10.9 M 6 X 16 Z.BIANCA	SCREW ISO 7380 CL 10.9 M 6 X 16 Z. WHITE	VIS TBEI PG ISO 7380 CL 10.9 M 6 X 16 Z.BLANC	SCHRAUBE ISO 7380 CL 10.9 M 6 X 16 Z. WEIß	TORNILLO TBEI PG ISO 7380 CL 10.9 M 6 X 16 GALVANIZADO BLANCO
BV36	BV003600	NR	VITE TCEI PG DIN 912 CL 8.8 M 5 X 8 Z.BIANCA	SCREW DIN 912 PG CL 8.8 M 5 X 8 Z. WHITE	VIS DIN 912 CL 8.8 M 5 X 8 GALVANISATION BLANCHE	SCHRAUBE	TORNILLO
BV37	BV003700	NR	VITE TSPEI PG DIN 7991 CL 10.9 M 5 X 60 Z.BIANCA	SCREW DIN 7991 CL 10.9 M 5 X 60 Z. WHITE	VIS DIN 7991 CL 10.9 M 5 X 60 GALVANISATION BLANCHE	SCHRAUBE	TORNILLO
BV38	BV003800	NR	VITE TE PARZIALE FILETTO PG DIN 931 CL 8.8 M 5 X 60 Z.BIANCA	SCREW PARTIAL THREAD DIN 931 PG CL 8.8 M 5 X 60 Z. WHITE	VIS PARTILLEMENT FILETÉE DIN 931 CL 8.8 M 5 X 60 GALVANISATION BLANCHE	SCHRAUBE	TORNILLO
BV39	BV003900	NR	VITE TCEI PG DIN 912 CL 8.8 M 5 X 60 Z.BIANCA	SCREW DIN 912 PG CL 8.8 M 5 X 60 Z. WHITE	VIS DIN 912 CL 8.8 M 5 X 60 GALVANISATION BLANCHE	SCHRAUBE	TORNILLO





POS	Codice	U.M.	 Descrizione	 Description	 Designation	 Benennung	 Descripción
BV40	BV004000	NR	VITE TE PARZIALE FILETTO PG DIN 931 CL 8.8 M 5 X 55 Z.BIANCA	SCREW PARTIAL THREAD DIN 931 PG CL 8.8 M 5 X 55 Z. WHITE	VIS PARTIELLEMENT FILETÉE DIN 931 CL 8.8 M 5 X 55 GALVANISATION BLANCHE	SCHRAUBE	TORNILLO
BV41	BV004100	NR	VITE TE TUTTO FILETTO PG DIN 933 CL 8.8 M 5 X 16 Z.BIANCA	SCREW ALL THREAD DIN 933 PG CL 8.8 M 5 X 16 Z. WHITE	VIS TE ENTIÈREMENT FILETÉE PG DIN 933 CL 8.8 M 5 X 16 Z.BLANC	VOLLGEWINDESCHRAUBE DIN 933 PG CL 8.8 M 5 X 16 Z. WEIß	TORNILLO TOTALMENTE ROSCADO PG DIN 933 CL 8.8 M 5 X 16 GALVANIZADO BLANCO
BV42	BV004200	NR	VITE TC CROCE PG DIN 7985 CL 4.8 M 5 X 16 Z.BIANCA	CROSS HEAD SCREW DIN 7985 PG CL 4.8 M 5 X 16 Z. WHITE	VIS TC EN CROIX PG DIN 7985 CL 4.8 M 5 X 16 Z.BLANC	KREUZSCHLITZSCHRAUBE DIN 7985 PG CL 4.8 M 5 X 16 Z. WEIß	TORNILLO TC DE CRUZ PG DIN 7985 CL 4.8 M 5 X 16 GALVANIZADO BLANCO
BV43	BV004300	NR	VITE TE TUTTO FILETTO PG DIN 933 CL 8.8 M 5 X 12 Z.BIANCA	SCREW ALL THREAD DIN 933 PG CL 8.8 M 5 X 12 Z. WHITE	VIS ENTIÈREMENT FILETÉE DIN 933 CL 8.8 M 5 X 12 GALVANISATION BLANCHE	SCHRAUBE	TORNILLO
BV44	BV004400	NR	VITE TE UNF ANSI B18.2.1 GR.5 5/16 X 1"1/4 Z.BIANCA	SCREW UNF ANSI B18.2.1 GR.5 5/16 X 1 "1/4 Z. WHITE	VIS UNF ANSI B18.2.1 GR.5 5/16 X 1"1/4 GALVANISATION BLANCHE	SCHRAUBE	TORNILLO
BV45	BV004500	NR	VITE TE UNF ANSI B18.2.1 GR.5 5/16 X 1"1/4 Z.BIANCA	SCREW UNF ANSI B18.2.1 GR.5 5/16 X 1 "1/4 Z. WHITE	VIS UNF ANSI B18.2.1 GR.5 5/16 X 1"1/4 GALVANISATION BLANCHE	SCHRAUBE	TORNILLO
BV46	BV004600	NR	VITE TCEI PG DIN 912 CL 8.8 M 4 X 40 Z.BIANCA	SCREW DIN 912 PG CL 8.8 M 4 X 40 Z. WHITE	VIS DIN 912 CL 8.8 M 4 X 40 GALVANISATION BLANCHE	SCHRAUBE	TORNILLO
BV47	BV004700	NR	VITE TRILOB. AUTOFORM. TC CROCE PG DIN 7500-C C15 M 4 X 40 Z.BIANCA	TRILOB SCREW. AUTOFORM. TC CROSS PH DIN 7500-C C 15 M 4 X 40 Z. WHITE	VIS TRILOB. AUTOFORM. TC CROIX PG DIN 7500-C C15 M 4 X 40 GALVANISATION BLANCHE	SCHRAUBE	TORNILLO
BV48	BV004800	NR	VITE TRILOB. AUTOFORM. TC CROCE PG DIN 7500-C C15 M 4 X 20 Z.BIANCA	TRILOB SCREW. AUTOFORM. TC CROSS PG DIN 7500-C C15 M 4 X 20 Z. WHITE	VIS TRILOB. AUTOFORM. TC CROIX PG DIN 7500-C C15 M 4 X 20 GALVANISATION BLANCHE	SCHRAUBE	TORNILLO
BV49	BV004900	NR	VITE TC CROCE PG DIN 7985 CL 4.8 M 4 X 16 Z.BIANCA	CROSS HEAD SCREW DIN 7985 PG CL 4.8 M 4 X 16 Z. WHITE	VIS TC CROIX DIN 7985 CL 4.8 M 4 X 16 GALVANISATION BLANCHE	SCHRAUBE	TORNILLO
BV50	BV005000	NR	VITE AUTOFILETTANTE TE C/BORDINO DIN 6928 C15 4,8X50 Z.BIANCA	TAPPING SCREW TE C / BORDINO DIN 6928 C15 4.8 X50 Z. WHITE	VIS AUTOFILETÉE TE C/BORDINO DIN 6928 C15 4,8X50 GALVANISATION BLANCHE	SCHRAUBE	TORNILLO





POS	Codice	U.M.	 Descrizione	 Description	 Designation	 Benennung	 Descripción
BV51	BV005100	NR	VITE AUTOFILETTANTE TE C/BORDINO DIN 6928 C15 4,8X25 Z.BIANCA	TAPPING SCREW TE C / BORDINO DIN 6928 C15 4.8 X25 Z. WHITE	VIS AUTOFILETÉE TE C/BORDINO DIN 6928 C15 4,8X25 GALVANISATION BLANCHE	SCHRAUBE	TORNILLO
BV52	BV005200	NR	VITE TCEI PG DIN 912 CL 12.9 M 3 X 25 Z.D.BIANCA	SCREW DIN 912 M 3 CL 12.9 X 25 Z.D. WHITE	VIS TCEI PG DIN 912 CL 12.9 M 3 X 25 GALVANISATION BLANCHE	SCHRAUBE	TORNILLO
BV53	BV005300	NR	VITE TSPEI PG DIN 7991 CL 10.9 M 3 X 14 Z.BIANCA	SCREW DIN 7991 CL 10.9 M 3 X 14 Z. WHITE	VIS DIN 7991 CL 10.9 M 3 X 14 GALVANISATION BLANCHE	SCHRAUBLE	TORNILLO
BV54	BV005400	NR	VITE AUTOFIL.TC CROCE DIN 7981 C15 3,5 X 6,5 Z.BIANCA	AUTOFIL.TC CROSS SCREW DIN 7981 C15 3.5 X 6.5 Z. WHITE	VIS AUTOFILETÉE CROIX DIN 7981 C15 3,5 X 6,5 GALVANISATION BLANCHE	SCHRAUBE	TORNILLO
BV55	BV005500	NR	VITE TE PARZIALE FILETTO PG DIN 931 CL 10.9 M 16 X 55	SCREW PARTIAL THREAD DIN 931 PG CL 10.9 M 16 X 55	VIS TE PARTIELLEMENT FILETÉE PG DIN 931 CL 10.9 M 16 X 55	TEILGEWINDESCHRAUBE DIN 931 PG CL 10.9 M 16 X 55	TORNILLO PARCIALMENTE ROSCADO PG DIN 931 CL 10.9 M 16 X 55
BV56	BV005600	NR	VITE TE TUTTO FILETTO PG DIN 933 CL 8.8 M 16 X 40 Z.BIANCA	SCREW ALL THREAD DIN 933 PG CL 8.8 M 16 X 40 Z. WHITE	VIS ENTIÈREMENT FILETÉE DIN 933 CL 8.8 M 16 X 40 GALVANISATION BLANCHE	SCHRAUBE	TORNILLO
BV57	BV005700	NR	VITE TE PARZIALE FILETTO PG DIN 931 CL 10.9 M 16 X 220	SCREW PARTIAL THREAD DIN 931 PG CL 10.9 M 16 X 220	VIS PARTIELLEMENT FILETÉE DIN 931 CL 10.9 M 16 X 220	SCHRAUBE	TORNILLO
BV58	BV005800	NR	VITE TE 8.8 DIN933 M16X20 TESTA ALTA 8 ZN BIANCA	SCREW M16X20 DIN933 8.8 HEAD HIGH 8 ZN WHITE	VIS 8.8 DIN933 M16X20 TÊTE HAUTE 8 GALVANISATION BLANCHE	SCHRAUBE	TORNILLO
BV59	BV005900	NR	VITE TE TUTTO FILETTO PG DIN 933 CL 8.8 M 12 X 16 Z.BIANCA	SCREW ALL THREAD DIN 933 PG CL 8.8 M 12 X 16 Z. WHITE	VIS ENTIÈREMENT FILETÉE DIN 933 CL 8.8 M 12 X 16 GALVANISATION BLANCHE	SCHRAUBE	TORNILLO
BV60	BV006000	NR	VITE TE PARZIALE FILETTO PG DIN 931 CL 8.8 M 12 X 120 Z.BIANCA	SCREW PARTIAL THREAD DIN 931 PG CL 8.8 M 12 X 120 Z. WHITE	VIS PARTIELLEMENT FILETÉE DIN 931 CL 8.8 M 12 X 120 GALVANISATION BLANCHE	SCHRAUBE	TORNILLO
BV61	BV006100	NR	VITE TE PARZIALE FILETTO PG DIN 931 CL 8.8 M 10 X 50 Z.BIANCA	SCREW PARTIAL THREAD DIN 931 PG CL 8.8 M 10 X 50 Z. WHITE	VIS TE PARTIELLEMENT FILETÉE PG DIN 931 CL 8.8 M 10 X 50 Z.BLANC	TEILGEWINDESCHRAUBE DIN 931 PG CL 8.8 M 10 X 50 Z. WEIß	TORNILLO PARCIALMENTE ROSCADO PG DIN 931 CL 8.8 M 10 X 50 GALVANIZADO BLANCO





POS	Codice	U.M.	 Descrizione	 Description	 Designation	 Benennung	 Descripción
BV62	BV006200	NR	VITE TE TUTTO FILETTO PG DIN 933 CL 8.8 M 10 X 35 Z.BIANCA	SCREW ALL THREAD DIN 933 PG CL 8.8 M 10 X 35 Z. WHITE	VIS TE ENTIÈREMENT FILETÉE PG DIN 933 CL 8.8 M 10 X 35 Z.BLANC	VOLLGEWINDESCHRAUBE DIN 933 PG CL 8.8 M 10 X 35 Z. WEIß	TORNILLO TOTALMENTE ROSCADO PG DIN 933 CL 8.8 M 10 X 35 GALVANIZADO BLANCO
BV63	BV006300	NR	VITE TSPEI PG DIN 7991 CL 10.9 M 10 X 30 Z.BIANCA	SCREW DIN 7991 CL 10.9 M 10 X 30 Z. WHITE	VIS DIN 7991 CL 10.9 M 10 X 30 GALVANISATION BLANCHE	SCHRAUBE	TORNILLO
BV64	BV006400	NR	VITE TE TUTTO FILETTO PG DIN 933 CL 8.8 M 10 X 30 Z.BIANCA	SCREW ALL THREAD DIN 933 PG CL 8.8 M 10 X 30 Z. WHITE	VIS TE ENTIÈREMENT FILETÉE PG DIN 933 CL 8.8 M 10 X 30 Z.BLANC	VOLLGEWINDESCHRAUBE DIN 933 PG CL 8.8 M 10 X 30 Z. WEIß	TORNILLO PG DIN 933 CL 8.8 M 10 X 30 GALVANIZADO BLANCO
BV65	BV006500	NR	VITE TCEI PG DIN 912 CL 12.9 M 10 X 25 GEO 321 A	SCREW DIN 912 PG CL 12.9 M 10 X 25 GEO 321 A	VIS DIN 912 PG CL 12.9 M 10 X 25 GEO 321 A	SCHRAUBE DIN 912 PG CL 12.9 M 10 X 25 GEO 321 A	TORNILLO TCEI PG DIN 912 CL 12.9 M 10 X 25 GEO 321 A
BV66	BV006600	NR	VITE TCEI PG DIN 912 CL 8.8 M 10 X 25 Z.BIANCA	SCREW DIN 912 PG CL 8.8 M 10 X 25 Z. WHITE	VIS DIN 912 CL 8.8 M 10 X 25 GALVANISATION BLANCHE	SCHRAUBE	TORNILLO
BV67	BV006700	NR	VITE TE TUTTO FILETTO PG DIN 933 CL 8.8 M 10 X 20 Z.BIANCA	SCREW ALL THREAD DIN 933 PG CL 8.8 M 10 X 20 Z. WHITE	VIS ENTIÈREMENT FILETÉE PG DIN 933 CL 8.8 M 10 X 20 Z.BLANC	VOLLGEWINDESCHRAUBE DIN 933 PG CL 8.8 M 10 X 20 Z. WEIß	TORNILLO TOTALMENTE ROSCADO PG DIN 933 CL 8.8 M 10 X 20 GALVANIZADO BLANCO
BV68	BV006800	NR	VITE TE TUTTO FILETTO PG DIN 933 CL 8.8 M 10 X 18 Z.BIANCA	SCREW ALL THREAD DIN 933 PG CL 8.8 M 10 X 18 Z. WHITE	VIS ENTIÈREMENT FILETÉE DIN 933 PG CL 8.8 M 10 X 18 Z. BLANC	VOLLGEWINDESCHRAUBE DIN 933 PG CL 8.8 M 10 X 18 Z. WEIß	TORNILLO TOTALMENTE ROSCADO PG DIN 933 CL 8.8 M 10 X 18 GALVANIZADO BLANCO
BV69	BV006900	NR	VITE TRILOB. AUTOFORM. TSP CROCE PG DIN 7500-M C15 M 5 X 16 Z.BIANCA	TRILOB SCREW. AUTOFORM. TSP CROSS PG DIN 7500-M C15 M 5 X 16 Z. WHITE	VIS TRILOB. AUTOFORM. TSP CROIX PG DIN 7500-M C15 M 5 X 16 GALVANISATION BLANCHE	SCHRAUBE	TORNILLO
BV70	BV007000	NR	VITE TE PARZIALE FILETTO PG DIN 931 CL 8.8 M 8 X 70 Z.BIANCA	SCREW PARTIAL THREAD DIN 931 PG CL 8.8 M 8 X 70 Z. WHITE	VIS PARTIELLEMENT FILETÉE DIN 931 PG CL 8.8 M 8 X 70 Z. BLANC	TEILGEWINDESCHRAUBE DIN 931 PG CL 8.8 M 8 X 70 Z. WEIß	TORNILLO PARCIALMENTE ROSCADO PG DIN 931 CL 8.8 M 8 X 70 GALVANIZADO BLANCO
BV71	BV007100	NR	VITE TE PARZIALE FILETTO PG DIN 931 CL 8.8 M 8 X 65 Z.BIANCA	SCREW PARTIAL THREAD DIN 931 PG CL 8.8 M 8 X 65 Z. WHITE	VIS PARTIELLEMENT FILETÉE DIN 931 CL 8.8 M 8 X 65 GALVANISÉE BLANCHE	TEILGEWINDESCHRAUBE DIN 931 PG CL 8.8 M 8 X 65 Z. WEIß	TORNILLO PARCIALMENTE ROSCADO DIN 931 CL 8.8 M 8 X 65 GALVANIZADO BLANCO
BV72	BV007200	NR	VITE TE PARZIALE FILETTO PG DIN 931 CL 8.8 M 6 X 55 Z.BIANCA	SCREW PARTIAL THREAD DIN 931 PG CL 8.8 M 6 X 55 Z. WHITE	VIS PARTIELLEMENT FILETÉE DIN 931 CL 8.8 M 6 X 55 GALVANISÉE BLANCHE	TEILGEWINDESCHRAUBE DIN 931 PG CL 8.8 M 6 X 55 Z. WEIß	TORNILLO PARCIALMENTE ROSCADO DIN 931 CL 8.8 M 6 X 55 GALVANIZADO BLANCO





POS	Codice	U.M.	 Descrizione	 Description	 Designation	 Benennung	 Descripción
BV73	BV007300	NR	VITE TCEI PG DIN 912 CL 8.8 M 6 X 55 Z.BIANCA	SCREW DIN 912 PG CL 8.8 M 6 X 55 Z. WHITE	VIS TCEI PG DIN 912 CL 8.8 M 6 X 55 GALVANISATION BLANCHE	SCHRAUBE	TORNILLO
BV74	BV007400	NR	VITE TCEI PG DIN 912 CL 8.8 M 6 X 16 Z.BIANCA	SCREW DIN 912 PG CL 8.8 M 6 X 16 Z. WHITE	VIS DIN 912 CL 8.8 M 6 X 16 GALVANISATION BLANCHE	SCHRAUBE	TORNILLO
BV75	BV007500	NR	VITE TSPEI PG DIN 7991 CL 10.9 M 6 X 10 Z.BIANCA	SCREW DIN 7991 CL 10.9 M 6 X 10 Z. WHITE	VIS DIN 7991 CL 10.9 M 6 X 10 GALVANISATION BLANCHE	SCHRAUBE	TORNILLO
BV76	BV007600	NR	VITE TCEI PG DIN 912 CL 8.8 M 5 X 55 Z.BIANCA	SCREW DIN 912 PG CL 8.8 M 5 X 55 Z. WHITE	VIS DIN 912 CL 8.8 M 5 X 55 GALVANISATION BLANCHE	SCHRAUBE	TORNILLO
BV77	BV007700	NR	VITE TC CROCE PG DIN 7985 CL 4.8 M 6 X 16 Z.BIANCA	CROSS HEAD SCREW DIN 7985 PG CL 4.8 M 6 X 16 Z. WHITE	VIS DIN 7985 CL 4.8 M 6 X 16 GALVANISATION BLANCHE	SCHRAUBE	TORNILLO
BV78	BV007800	NR	VITE TRILOB. AUTOFORM. TC CROCE PG DIN 7500-C C15 M 5 X 12 Z.BIANCA	TRILOB SCREW. AUTOFORM. TC CROSS PG DIN 7500-C C15 M 5 X 12 Z. WHITE	VIS TRILOB. AUTOFORM. TC CROIX PG DIN 7500-C C15 M 5 X 12 GALVANISATION BLANCHE	SCHRAUBE	TORNILLO
BV79	BV007900	NR	VITE TE TUTTO FILETTO PG DIN 933 CL 8.8 M 4 X 35 Z.BIANCA	SCREW ALL THREAD DIN 933 PG CL 8.8 M 4 X 35 Z. WHITE	VIS ENTIÈREMENT FILETÉE DIN 933 CL 8.8 M 4 X 35 GALVANISATION BLANCHE	SCHRAUBE	TORNILLO
BV80	BV008000	NR	VITE AUTOFILETTANTE TE C/BORDINO DIN 6928 C15 4,8X35 Z.BIANCA	TAPPING SCREW TE C / BORDINO DIN 6928 C15 4.8 X35 Z. WHITE	VIS AUTOFILETÉE TE C/BORDINO DIN 6928 C15 4,8X35 GALVANISATION BLANCHE	SCHRAUBE	TORNILLO
BV81	BV008100	NR	VITE TCEI PG DIN 912 CL 12.9 M 3 X 14 Z.D.BIANCA	SCREW DIN 912 M 3 CL 12.9 X 14 Z.D. WHITE	VIS DIN 912 CL 12.9 M 3 X 14 GALVANISATION BLANCHE	SCHRAUBE	TORNILLO
BV82	BV008200	NR	VITE TE PARZIALE FILETTO PG DIN 931 CL 8.8 M 16 X 70 Z.BIANCA	SCREW PARTIAL THREAD DIN 931 PG CL 8.8 M 16 X 70 Z. WHITE	VIS PARTIELLEMENT FILETÉE PG DIN 931 CL 8.8 M 16 X 70 GALVANISATION BLANCHE	SCHRAUBE	TORNILLO
BV83	BV008300	NR	VITE TE PARZIALE FILETTO PG DIN 931 CL 8.8 M 16 X 260 Z.BIANCA	SCREW PARTIAL THREAD DIN 931 PG CL 8.8 M 16 X 260 Z. WHITE	VIS PARTIELLEMENT FILETÉE PG DIN 931 CL 8.8 M 16 X 260 GALVANISATION BLANCHE	SCHRAUBE	TORNILLO
BV84	BV008400	NR	VITE TE PARZIALE FILETTO PG DIN 931 CL 8.8 M 12 X 110 Z.BIANCA	SCREW PARTIAL THREAD DIN 931 PG CL 8.8 M 12 X 110 Z. WHITE	VIS PARTIELLEMENT FILETÉE DIN 931 CL 8.8 M 12 X 110 GALVANISATION BLANCHE	SCHRAUBE	TORNILLO





POS	Codice	U.M.	 Descrizione	 Description	 Designation	 Benennung	 Descripción
BV85	BV008500	NR	VITE TE TUTTO FILETTO PG DIN 933 CL 8.8 M 10 X 40 Z.BIANCA	SCREW THREAD DIN 933 PG CL 8.8 M 10 X 40 Z. WHITE	VIS FILETÉE DIN 933 PG CL 8.8 M 10 X 40 Z. BLANC	TEILGEWINDESCHRAUBE DIN 933 PG CL 8.8 M 10 X 40 Z. WEIß	TORNILLO ROSCADO PG DIN 933 CL 8.8 M 10 X 40 GALVANIZADO BLANCO
BV86	BV008600	NR	VITE TCEI PG DIN 912 CL 8.8 M 8 X 65 Z.BIANCA	SCREW DIN 912 PG CL 8.8 M 8 X 65 Z. WHITE	VIS DIN 912 CL 8.8 M 8 X 65 GALVANISATION BLANCHE	SCHRAUBE	TORNILLO
BV87	BV008700	NR	VITE TCEI PG DIN 912 CL 8.8 M 8 X 20 Z.BIANCA	SCREW DIN 931 PG CL 8.8 M 10 X 40 Z. WHITE	VIS DIN 931 PG CL 8.8 M 10 X 40 Z. BLANC	SCHRAUBE DIN 931 PG CL 8.8 M 10 X 40 Z. WEIß	TORNILLO TCEI PG DIN 912 CL 8.8 M 8 X 20 GALVANIZADO BLANCO
BV88	BV008800	NR	VITE TCEI PG DIN 912 CL 10.9 M 10 X 18 Z.BIANCA	SCREW DIN 912 PG CL 10.9 M 10 X 18 Z. WHITE	VIS DIN 912 CL 10.9 M 10 X 18 GALVANISATION BLANCHE	SCHRAUBE	TORNILLO
BV89	BV008900	NR	VITE TCEI PG DIN 912 CL 8.8 M 8 X 70 Z.BIANCA	SCREW DIN 912 PG CL 8.8 M 8 X 70 Z. WHITE	VIS DIN 912 CL 8.8 M 8 X 70 GALVANISATION BLANCHE	SCHRAUBE	TORNILLO
BV91	BV009100	NR	VITE TE PARZIALE FILETTO PG DIN 931 CL 8.8 M 6 X 40 Z.BIANCA	SCREW PARTIAL THREAD DIN 931 PG CL 8.8 M 6 X 40 Z. WHITE	VIS FILETÉE DIN 931 PG CL 8.8 M 6 X 40 Z. BLANC	VOLLGEWINDESCHRAUBE DIN 931 PG CL 8.8 M 6 X 40 Z. WEIß	TORNILLO PG DIN 931 CL 8.8 M 6 X 40 GALVANIZADO BLANCO
BV92	BV009200	NR	VITE TE TUTTO FILETTO PG DIN 933 CL 8.8 M 10 X 60 Z.BIANCA	SCREW ALL THREAD DIN 933 PG CL 8.8 M 10 X 60 Z. WHITE	VIS	SCHRAUBE	TORNILLO
BV93	BV009300	NR	VITE TSPEI PG DIN 7991 CL 10.9 M 5 X 20 Z.BIANCA	SCREW DIN 7991 CL 10.9 M 5 X 20 Z. WHITE	VIS DIN 7991 CL 10.9 M 5 X 20 GALVANISATION BLANCHE	SCHRAUBE	TORNILLO
BV94	BV009400	NR	VITE TC CROCE PG DIN 7985 CL 4.8 M 4 X 12 Z.BIANCA	CROSS HEAD SCREW DIN 7985 PG CL 4.8 M 4 X 12 Z. WHITE	VIS CROIX DIN 7985 CL 4.8 M 4 X 12 GALVANISATION BLANCHE	SCHRAUBE	TORNILLO
BV95	BV009500	NR	VITE TE TUTTO FILETTO PG DIN 933 CL 8.8 M 4 X 12 Z.BIANCA	SCREW ALL THREAD DIN 933 PG CL 8.8 M 4 X 12 Z. WHITE	VIS ENTIÈREMENT FILETÉE DIN 933 CL 8.8 M 4 X 12 GALVANISATION BLANCHE	SCHRAUBE	TORNILLO
BV96	BV009600	NR	VITE TCEI PG DIN 912 CL 12.9 M 12 X 30 DAC 320A	SCREW DIN 912 CL 12.9 M 12 X 30 DAC 320A	VIS DIN 912 CL 12.9 M 12 X 30 DAC 320A	SCHRAUBE DIN 912 CL 12.9 M 12 X 30 DAC 320A	TORNILLO TCEI PG DIN 912 CL 12.9 M 12 X 30 DAC 320A
BV97	BV009700	NR	VITE AUTOFIL.TESTA MEZZA TONDA C15 4,8 X 13 Z.BIANCA	HALF ROUND HEAD SELF TAPPING SCREW C15 4,8 X 13	VIS AUTOFILETÉE TÊTE DEMI- RONDE C15 4,8 X 13 GALVANISATION BLANCHE	SCHRAUBE	TORNILLO





POS	Codice	U.M.	 Descrizione	 Description	 Designation	 Benennung	 Descripción
BV98	BV009800	NR	VITE TC CROCE PG DIN 7985 CL 4.8 M 4 X 14 Z.BIANCA	SCREW DIN 7985 CL 4.8 M 4 X 14	VIS EN CROIX PG DIN 7985 CL 4.8 M 4 X 14 GALVANISÉE BLANCHE	KREUZSCHLITZSCHRAUBE DIN 7985 CL 4.8 M 4 X 14	TORNILLO CRUZ 7985 CL 4.8 M 4 X 14 GALVANIZADO BLANCO
BV99	BV009900	NR	VITE TE PARZIALE FILETTO PG DIN 931 CL 8.8 M 5 X 65 Z.BIANCA	SCREW PARTIAL THREAD DIN 931 PG CL 8.8 M 5 X 65 Z. WHITE	VIS PARTIELLEMENT FILETÉE DIN 931 CL 8.8 M 5 X 65 GALVANISATION BLANCHE	SCHRAUBE	TORNILLO
BV100	BV010000	NR	VITE AUTOFIL.TESTA MEZZA TONDA C15 4,8 X 16 Z.BIANCA	HALF ROUND HEAD SELF TAPPING SCREW C15 4,8 X 16	VIS AUTOFILETÉE TÊTE DEMI-RONDE C15 4,8 X 16 GALVANISATION BLANCHE	SCHRAUBE	TORNILLO
BV101	BV010100	NR	VITE TSPEI PG DIN 7991 CL 10.9 M 8 X 25 Z.BIANCA	SCREW DIN 7991 CL 10.9 M 8 X 25 Z. WHITE	VIS DIN 7991 CL 10.9 M 8 X 25 GALVANISATION BLANCHE		
BV102	BV010200	NR	VITE TCEI PG DIN 912 CL 8.8 M 4 X 30 Z.BIANCA	SCREW DIN 912 PG CL 8.8 M 4 X 30 WHITE Z	VIS DIN 912 CL 8.8 M 4 X 30 GALVANISATION BLANCHE	SCHRAUBE	TORNILLO
BV103	BV010300	NR	VITE TSPEI PG DIN 7991 CL 10.9 M 5 X 16 Z.BIANCA	SCREW DIN 7991 CL 10.9 M 5 X 16 Z. WHITE	VIS DIN 7991 CL 10.9 M 5 X 16 GALVANISATION BLANCHE	SCHRAUBE	TORNILLO
BV104	BV010400	NR	VITE TCEI BASSA PG DIN 7984 CL 10.9 M 12 X 18 Z.D.BIANCA	SCREW DIN 7984 LOW PG CL 10.9 M 12 X 18 Z. D. WHITE	VIS BASSE DIN 7984 CL 10.9 M 12 X 18 Z. BLANCHE	SCHRAUBE	TORNILLO
BV105	BV010500	NR	VITE TE PARZIALE FILETTO PG DIN 931 CL 8.8 M 12 X 75 Z.BIANCA	SCREW PARTIAL THREAD DIN 931 PG CL 8.8 M 12 X 75 Z. WHITE	VIS PARTIELLEMENT FILETÉE DIN 931 CL 8.8 M 12 X 75 GALVANISATION BLANCHE	SCHRAUBE	TORNILLO
BV106	BV010600	NR	VITE TE TUTTO FILETTO PG DIN 933 CL 8.8 M 8 X 22 Z.BIANCA	SCREW ALL THREAD DIN 933 PG CL 8.8 M 8 X 22 Z. WHITE	VIS ENTIÈREMENT FILETÉE DIN 933 PG CL 8.8 M 8 X 22 Z. BLANC	VOLLGEWINDESCHRAUBE DIN 933 PG CL 8.8 M 8 X 22 Z. WEIß	TORNILLO TOTALMENTE ROSCADO PG DIN 933 CL 8.8 M 8 X 22 GALVANIZADO BLANCO
BV107	BV010700	NR	VITE TE TUTTO FILETTO PG DIN 933 CL 8.8 M 6 X 35 Z.BIANCA	SCREW ALL THREAD DIN 933 PG CL 8.8 M 6 X 35 Z. WHITE	VIS ENTIÈREMENT FILETÉE DIN 933 CL 8.8 M 6 X 35 GALVANISATION BLANCHE	SCHRAUBE	TORNILLO
BV108	BV010800	NR	VITE TE PARZIALE FILETTO PG DIN 931 CL 8.8 M 4 X 45 Z.BIANCA	SCREW PARTIAL THREAD DIN 931 PG CL 8.8 M 4 X 45 Z. WHITE	VIS PARTIELLEMENT FILETÉE DIN 931 CL 8.8 M 4 X 45 GALVANISATION BLANCHE	SCHRAUBE	TORNILLO
BV109	BV010900	NR	VITE TE TUTTO FILETTO PG DIN 933 CL 10.9 M 16 X 45 Z.D.BIANCA	SCREW ALL THREAD DIN 933 PG CL 10.9 M 16 X 45 ZD WHITE	VIS ENTIÈREMENT FILETÉE DIN 933 CL 10.9 M 16 X 45 GALVANISATION BLANCHE	SCHRAUBE	TORNILLO





POS	Codice	U.M.	 Descrizione	 Description	 Designation	 Benennung	 Descripción
BV110	BV011000	NR	VITE TE PARZIALE FILETTO PG DIN 931 CL 10.9 M 16 X 100	SCREW PARTIAL THREAD DIN 931 PG CL 10.9 M 16 X 100	VIS PARTIELLEMENT FILETÉE DIN 931 CL 10.9 M 16 X 100	SCHRAUBE	TORNILLO
BV111	BV011100	NR	VITE TE PARZIALE FILETTO PG DIN 931 CL 10.9 M 16 X 105	SCREW PARTIAL THREAD DIN 931 PG CL 10.9 M 16 X 105	VIS PARTIELLEMENT FILETÉE DIN 931 CL 10.9 M 16 X 105	SCHRAUBE	TORNILLO
BV112	BV011200	NR	VITE TE TUTTO FILETTO PG DIN 933 CL 8.8 M 10 X 25 Z.BIANCA	SCREW ALL THREAD DIN 933 PG CL 8.8 M 10 X 25 Z. WHITE	VIS ENTIÈREMENT FILETÉE DIN 933 PG CL 8.8 M 10 X 25 Z. BLANC	VOLLGEWINDESCHRAUBE DIN 933 PG CL 8.8 M 10 X 25 Z. WEIß	TORNILLO TOTALMENTE ROSCADO PG DIN 933 CL 8.8 M 10 X 25 GALVANIZADO BLANCO
BV113	BV011300	NR	VITE TSPEI PG DIN 7991 CL 10.9 M 6 X 50 Z.BIANCA	TSPEI PG SCREW DIN 7991 CL 10.9 M 6 X 50 Z. WHITE	VIS DIN 7991 CL 10.9 M 6 X 50 Z. BLANC	TSPEI PG SCHRAUBE DIN 7991 CL 10.9 M 6 X 50 Z. WEIß	TORNILLO TSPEI PG DIN 7991 CL 10.9 M 6 X 50 GALVANIZADO BLANCO
BV114	BV011400	NR	VITE TSPEI PG DIN 7991 CL 10.9 M 8 X 25 Z.BIANCA	TSPEI PG SCREW DIN 7991 CL 10.9 M 8 X 25 Z. WHITE	VIS DIN 7991 CL 10.9 M 8 X 25 GALVANISATION BLANCHE	SCHRAUBE	TORNILLO
BV115	BV011500	NR	VITE TE TUTTO FILETTO PG DIN 933 CL 8.8 M 10 X 45 Z.BIANCA	SCREW ALL THREAD DIN 933 PG CL 8.8 M 10 X 45 Z. WHITE	VIS ENTIÈREMENT FILETÉE DIN 933 CL 8.8 M 10 X 45 GALVANISATION BLANCHE	SCHRAUBE	TORNILLO
BV116	BV011600	NR	VITE TE TUTTO FILETTO PG DIN 933 CL 8.8 M 5 X 8 Z.BIANCA	SCREW ALL THREAD DIN 933 PG CL 8.8 M 5 X 8 Z. WHITE	VIS ENTIÈREMENT FILETÉE DIN 933 CL 8.8 M 5 X 8 GALVANISATION BLANCHE	SCHRAUBE	TORNILLO
BV117	BV011700	NR	VITE TE TUTTO FILETTO PG DIN 933 CL 8.8 M 8 X 18 Z.BIANCA	SCREW ALL THREAD DIN 933 PG CL 8.8 M 8 X 18 Z. WHITE	VIS ENTIÈREMENT FILETÉE DIN 933 CL 8.8 M 8 X 18 GALVANISATION BLANCHE	SCHRAUBE	TORNILLO
BV118	BV011800	NR	VITE TE TUTTO FILETTO PG DIN 933 CL 8.8 M 8 X 40 Z.BIANCA	SCREW ALL THREAD DIN 933 PG CL 8.8 M 8 X 40 Z. WHITE	VIS ENTIÈREMENT FILETÉE DIN 933 PG CL 8.8 M 8 X 40 Z. BLANC	VOLLGEWINDESCHRAUBE DIN 933 PG CL 8.8 M 8 X 40 Z. WEIß	TORNILLO DIN 933 CL 8.8 M 8 X 40 GALVANIZADO BLANCO
BV119	BV011900	NR	VITE TCEI PG DIN 912 CL 8.8 M 8 X 100 Z.BIANCA	SCREW DIN 912 PG CL 8.8 M 8 X 100 Z. WHITE	VIS DIN 912 CL 8.8 M 8 X 100 GALVANISATION BLANCHE	SCHRAUBE	TORNILLO
BV120	BV012000	NR	VITE TCEI PG DIN 912 CL 8.8 M 8 X 110 Z.BIANCA	SCREW DIN 912 PG CL 8.8 M 8 X 110 Z. WHITE	VIS DIN 912 CL 8.8 M 8 X 110 GALVANISATION BLANCHE	SCHRAUBE	TORNILLO
BV121	BV012100	NR	VITE TE PARZIALE FILETTO PG DIN 931 CL 8.8 M 5 X 75 Z.BIANCA	SCREW PARTIAL THREAD DIN 931 PG CL 8.8 M 5 X 75 Z. WHITE	VIS PARTIELLEMENT FILETÉE DIN 931 CL 8.8 M 5 X 75 GALVANISATION BLANCHE	SCHRAUBE	TORNILLO





POS	Codice	U.M.	 Descrizione	 Description	 Designation	 Benennung	 Descripción
BV122	BV012200	NR	VITE TE PARZIALE FILETTO PG DIN 931 CL 8.8 M 12 X 130 Z.BIANCA	SCREW PARTIAL THREAD DIN 931 PG CL 8.8 M 12 X 130 Z. WHITE	VIS PARTIELLEMENT FILETÉE DIN 931 CL 8.8 M 12 X 130 GALVANISATION BLANCHE	SCHRAUBE	TORNILLO
BV123	BV012300	NR	VITE TC CROCE PG DIN 7985 CL 4.8 M 4 X 8 Z.BIANCA	CROSS HEAD SCREW DIN 7985 PG CL 4.8 M 4 X 8 Z. WHITE	VIS TC EN CROIX PG DIN 7985 CL 4.8 M 4 X 8 Z.BLANC	KREUZSCHLITZCHRAUBE DIN 7985 PG CL 4.8 M 4 X 8 Z. WEIß	TORNILLO TC DE CRUZ PG DIN 7985 CL 4.8 M 4 X 8 GALVANIZADO BLANCO
BV124	BV012400	NR	VITE TCEI PG DIN 912 CL 8.8 M 6 X 40 Z.BIANCA	SCREW DIN 912 PG CL 8.8 M 6 X 40 Z. WHITE	VIS DIN 912 CL 8.8 M 6 X 40 GALVANISATION BLANCHE	SCHRAUBE	TORNILLO
BV125	BV012500	NR	VITE TE TUTTO FILETTO PG DIN 933 CL 8.8 M 4 X 20 Z.BIANCA	SCREW ALL THREAD DIN 933 PG CL 8.8 M 4 X 20 Z. WHITE	VIS ENTIÈREMENT FILETÉE DIN 933 CL 8.8 M 4 X 20 GALVANISATION BLANCHE	SCHRAUBE	TORNILLO
BV126	BV012600	NR	VITE TE UNC ANSI B18.2.1 GR.5 3/8 X 1" Z.BIANCA	SCREW UNC ANSI B18.2.1 GR.5 3/8 X 1" Z. WHITE	VIS UNC ANSI B18.2.1 GR.5 3/8 X 1" GALVANISATION BLANCHE	SCHRAUBE	TORNILLO
BV127	BV012700	NR	VITE TE UNC ANSI B18.2.1 GR.5 3/8 X 1" 1/4Z.BIANCA	SCREW UNC ANSI B18.2.1 GR.5 3/8 X 1" 1/4 Z. WHITE	VIS UNC ANSI B18.2.1 GR.5 3/8 X 1" 1/4 GALVANISATION BLANCHE	SCHRAUBE	TORNILLO
BV128	BV012800	NR	VITE TE TUTTO FILETTO PG DIN 933 CL 8.8 M 4 X 16 Z.BIANCA	SCREW ALL THREAD DIN 933 PG CL 8.8 M 4 X 16 Z. WHITE	VIS ENTIÈREMENT FILETÉE DIN 933 CL 8.8 M 4 X 16 GALVANISATION BLANCHE	SCHRAUBE	TORNILLO
BV129	BV012900	NR	VITE TCEI PG DIN 912 CL 8.8 M 5 X 16 Z.BIANCA	SCREW DIN 912 PG CL 8.8 M 5 X 16 Z. WHITE	VIS DIN 912 CL 8.8 M 5 X 16 GALVANISATION BLANCHE	SCHRAUBE	TORNILLO
BV130	BV013000	NR	VITE TCEI PG DIN 912 CL 8.8 M 3 X 12 Z.BIANCA	SCREW DIN 912 PG CL 8.8 M 3 X 12 Z. WHITE	VIS DIN 912 CL 8.8 M 3 X 12 GALVANISATION BLANCHE	SCHRAUBE	TORNILLO
BV131	BV013100	NR	VITE TSPEI PG DIN 7991 CL 10.9 M 5 X 30 Z.BIANCA	TSPEI PG SCREW DIN 7991 CL 10.9 M 5 X 30 Z. WHITE	VIS DIN 7991 CL 10.9 M 5 X 30 GALVANISATION BLANCHE	SCHRAUBE	TORNILLO
BV132	BV013200	NR	VITE TSPEI PG DIN 7991 CL 10.9 M 5 X 55 Z.BIANCA	TSPEI PG SCREW DIN 7991 CL 10.9 M 5 X 55 Z. WHITE	VIS DIN 7991 CL 10.9 M 5 X 55 GALVANISATION BLANCHE	SCHRAUBE	TORNILLO
BV133	BV013300	NR	VITE TE TUTTO FILETTO PG DIN 933 CL 8.8 M 3 X 25 Z.BIANCA	SCREW ALL THREAD DIN 933 PG CL 8.8 M 3 X 25 Z. WHITE	VIS ENTIÈREMENT FILETÉE DIN 933 CL 8.8 M 3 X 25 GALVANISATION BLANCHE	SCHRAUBE	TORNILLO
BV134	BV013400	NR	VITE TE PARZIALE FILETTO PG DIN 931 CL 8.8 M 10 X 65 Z.BIANCA	SCREW PARTIAL THREAD DIN 931 PG CL 8.8 M 10 X 65 Z. WHITE	VIS PARTIELLEMENT FILETÉE DIN 931 CL 8.8 M 10 X 65 GALVANISATION BLANCHE	SCHRAUBE	TORNILLO





POS	Codice	U.M.	 Descrizione	 Description	 Designation	 Benennung	 Descripción
BV135	BV013500	NR	VITE TCEI PG DIN 912 CL 8.8 M 12 X 50	SCREW DIN 912 CL 9.8 M 12 X 50	VIS DIN 912 CL 8.8 M 12 X 50	SCHRAUBE DIN 912 CL 8.8 M 12 X 50	TORNILLO DIN 912 CL 8.8 M 12 X 50
BV136	BV013600	NR	VITE TSPEI PG DIN 7991 CL 10.9 M 5 X 25 Z.BIANCA	TSPEI PG SCREW DIN 7991 CL 10.9 M 5 X 25 Z. WHITE	VIS DIN 7991 CL 10.9 M 5 X 25 GALVANISATION BLANCHE	SCHRAUBE	TORNILLO
BV137	BV013700	NR	VITE TCEI PG DIN 912 CL 8.8 M 8 X 30	SCREW DIN 912 CL 8.8 M 8 X 30	VIS DIN 912 CL 8.8 M 8 X 30	SCHRAUBE DIN 912 CL 8.8 M 8 X 30	TORNILLO DIN 912 CL 8.8 M 8 X 30
BV138	BV013800	NR	VITE TC CROCE PG DIN 7985 CL 4.8 M 5 X 10 Z.BIANCA	SCREW DIN 7985 CL 4.8 M 5 X 10	VIS CROIX DIN 7985 CL 4.8 M 5 X 10 GALVANISATION BLANCHE	SCHRAUBE	TORNILLO
BV139	BV013900	NR	VITE TCEI PG DIN 912 CL 8.8 M 4 X 25 Z. BIANCA	SCREW DIN 912 CL 8.8 M 4 X 25 Z.WITHE	VIS DIN 912 CL 8.8 M 4 X 25 GALVANISATION BLANCHE	SCHRAUBE	TONILLO
BV140	BV014000	NR	VITE TE PARZIALE FILETTO PG DIN 931 CL 8.8 M 5 X 70 Z.BIANCA	SCREW PARTIAL THREAD DIN 931 PG CL 8.8 M 5 X 70 Z. WHITE	VIS PARTIELLEMENT FILETÉE DIN 931 CL 8.8 M 5 X 70 GALVANISATION BLANCHE	SCHRAUBE	TORNILLO
BV141	BV014100	NR	VITE TE PARZIALE FILETTO PG DIN 931 CL 8.8 M 12 X 90 Z.BIANCA	SCREW PARTIAL THREAD DIN 931 PG CL 8.8 M 12 X 90 Z. WHITE	VIS PARTIELLEMENT FILETÉE DIN 931 CL 8.8 M 12 X 90 GALVANISATION BLANCHE	SCHRAUBE	TORNILLO
BV142	BV014200	NR	VITE TE PARZIALE FILETTO PG DIN 931 CL 8.8 M 8 X 55 Z.BIANCA	SCREW PARTIAL THREAD DIN 931 PG CL 8.8 M 8 X 55 Z. WHITE	VIS PARTIELLEMENT FILETÉE DIN 931 CL 8.8 M 8 X 55 GALVANISATION BLANCHE	SCHRAUBE	TORNILLO
BV143	BV014300	NR	VITE TSPEI PG DIN 7991 CL 10.9 M 10 X 20 Z.BIANCA	TSPEI PG SCREW DIN 7991 CL 10.9 M 10 X 20 Z. WHITE	VIS DIN 7991 CL 10.9 M 10 X 20 GALVANISATION BLANCHE	SCHRAUBE	TORNILLO
BV144	BV014400	NR	VITE TE TUTTO FILETTO PG DIN 933 CL 8.8 M 12 X 20 Z.BIANCA	SCREW ALL THREAD DIN 933 PG CL 8.8 M 12 X 20 Z. WHITE	VIS ENTIÈREMENT FILETÉE DIN 933 CL 8.8 M 12 X 20 GALVANISATION BLANCHE	SCHRAUBE	TORNILLO
BV145	BV014500	NR	VITE TE TUTTO FILETTO PG DIN 933 CL 8.8 M 12 X 35 Z.BIANCA	SCREW ALL THREAD DIN 933 PG CL 8.8 M 12 X 35 Z. WHITE	VIS ENTIÈREMENT FILETÉE DIN 933 PG CL 8.8 M 12 X 35 Z. BLANC	VOLLGEWINDESCHRAUBE DIN 933 PG CL 8.8 M 12 X 35 Z. WEIß	TORNILLO TOTALMENTE ROSCADO DIN 933 CL 8.8 M 12 X 35 GALVANIZADO BLANCO
BV146	BV014600	NR	VITE TE TUTTO FILETTO PF DIN 961 CL 10.9 M 10 X 1,25 X 25 Z.D.BIANCO	ALL PF THREAD HEX HEAD SCREW DIN 961 CL 10.9 M 10 X 1,25 X 25 Z.BIANCA	VIS ENTIÈREMENT FILETÉE DIN 961 CL 10.9 M 10 X 1,25 X 25 GALVANISÉE BLANCHE	VOLLGEWINDESCHRAUBE DIN 961 CL 10.9 M 10 X 1,25 X 25 Z. WEIß	TORNILLO TOTALMENTE ROSCADO DIN 961 CL 10.9 M 10 X 1,25 X 25 GALVANIZADO BLANCO

POS	Codice	U.M.	 Descrizione	 Description	 Designation	 Benennung	 Descripción
BV147	BV014700	NR	VITE TSPEI PARZIALE FILETTO PG DIN 7991 CL 10.9 M 12 X 90 Z.BIANCA	TSPEI PARTIAL THREAD PG SCREW DIN 7991 CL 10.9 M12 X 90 Z. WHITE	VIS TSPEI PG DIN 7991 CL 10.9 M 12 X 90 GALVANISATION BLANCHE	SCHRAUBE	TORNILLO
BV148	BV014800	NR	VITE TSPEI PG DIN 7991 CL 10.9 M 6 X 16 Z.BIANCA	TSPEI PG SCREW DIN 7991 CL 10.9 M6 X 16 Z. WHITE	VIS TSPEI PG DIN 7991 CL 10.9 M 6 X 16 GALVANISATION BLANCHE	SCHRAUBE	TORNILLO
BV149	BV014900	NR	VITE TBEI PG ISO 7380 CL 10.9 M 6 X 20 Z.BIANCA	HEX SOCKET SCREW ISO 7380 PG CL 10.9 M 6 X 20 Z. WHITE	VIS ISO 7380 CL 10.9 M 6 X 20 GALVANISATION BLANCHE	SCHRAUBE	TORNILLO
BV150	BV015000	NR	VITE TE TUTTO FILETTO PG DIN 933 CL 10.9 M 14 X 40 Z.BIANCA	SCREW ALL THREAD DIN 933 PG CL 10.9 M 14 X 40 Z. WHITE	VIS ENTIÈREMENT FILETÉE DIN 933 CL 10.9 M 14 X 40 GALVANISATION BLANCHE	SCHRAUBE	TORNILLO
BV151	BV015100	NR	VITE TE PARZIALE FILETTO PG DIN 931 CL 8.8 M 10 X 85 Z.BIANCA	SCREW PARTIAL THREAD DIN 931 PG CL 8.8 M 10 X 85 Z. WHITE	VIS PARTIELLEMENT FILETÉE DIN 931 PG CL 8.8 M 10 X 85 Z. BLANC	TEILGEWINDESCHRAUBE DIN 931 PG CL 8.8 M 10 X 85 Z. WEIß	TORNILLO PARCIALMENTE ROSCADO PG DIN 931 CL 8.8 M 10 X 85 GALVANIZADO BLANCO
BV152	BV015200	NR	VITE TE PARZIALE FILETTO PG DIN 931 CL 8.8 M 10 X 75 Z.BIANCA	SCREW PARTIAL THREAD DIN 931 PG CL 8.8 M 10 X 75 Z. WHITE	VIS PARTIELLEMENT FILETÉE DIN 931 PG CL 8.8 M 10 X 75 Z. BLANC	TEILGEWINDESCHRAUBE DIN 931 PG CL 8.8 M 10 X 75 Z. WEIß	TORNILLO PARCIALMENTE ROSCADO PG DIN 931 CL 8.8 M 10 X 75 GALVANIZADO BLANCO
BV154	BV015400	NR	VITE TCEI PG DIN 912 CL 8.8 M 8 X 35	SCREW DIN 912 CL 8.8 M 8 X 35	VIS DIN 912 CL 8.8 M 8 X 35	SCHRAUBE DIN 912 CL 8.8 M 8 X 35	TORNILLO TCEI PG DIN 912 CL 8.8 M 8 X 35
BV155	BV015500	NR	VITE TCEI PG DIN 912 CL 8.8 M 5 X 20 GEOMET 321A	SCREW DIN 912 CL 8.8 M 5 X 20 GEOMET 321A	VIS DIN 912 CL 8.8 M 5 X 20 GEOMET 321A	SCHRAUBE DIN 912 CL 8.8 M 5 X 20 GEOMET 321A	TORNILLO TCEI PG DIN 912 CL 8.8 M 5 X 20 GEOMET 321A
BV156	BV015600	NR	VITE TBEI PG ISO 7380 CL 10.9 M 6 X 25 Z.BIANCA	HEX SOCKET SCREW ISO 7380 PG CL 10.9 M 6 X 25 Z. WHITE	VIS ISO 7380 PG CL 10.9 M 6 X 25 Z. BLANC	SCHRAUBE ISO 7380 PG CL 10.9 M 6 X 25 Z. WEIß	TORNILLO TBEI PG ISO 7380 CL 10.9 M 6 X 25 GALVANIZADO BLANCO
BV157	BV015700	NR	VITE TBEI PG ISO 7380 CL 10.9 M 8 X 20 Z.BIANCA	HEX SOCKET SCREW ISO 7380 PG CL 10.9 M 8 X 20 Z. WHITE	VIS ISO 7380 PG CL 10.9 M 8 X 20 Z. BLANC	TBEI PG SCHRAUBE ISO 7380 CL 10.9 M 8 X 20 Z. WEIß	TORNILLO TBEI PG ISO 7380 CL 10.9 M 8 X 20 GALVANIZADO BLANCO
BV158	BV015800	NR	VITE TBEI PG ISO 7380 CL 10.9 M 6 X 70 Z.BIANCA	HEX SOCKET SCREW ISO 7380 PG CL 10.9 M 6 X 70 Z. WHITE	VIS ISO 7380 PG CL 10.9 M 6 X 70 Z. BLANC	TBEI PG SCHRAUBE ISO 7380 PG CL 10.9 M 6 X 70 Z. WEIß	TORNILLO TBEI PG ISO 7380 CL 10.9 M 6 X 70 GALVANIZADO BLANCO





POS	Codice	U.M.	 Descrizione	 Description	 Designation	 Benennung	 Descripción
BV159	BV015900	NR	VITE TBEI PG ISO 7380 CL 10.9 M 10 X 20 Z.BIANCA	HEX SOCKET SCREW ISO 7380 PG CL 10.9 M 10 X 20 Z. WHITE	VIS SO 7380 PG CL 10.9 M 10 X 20 Z. BLANC	TBEI PG SCHRAUBE ISO 7380 PG CL 10.9 M 10 X 20 Z. WEIß	TORNILLO TBEI PG ISO 7380 CL 10.9 M 10 X 20 GALVANIZADO BLANCO
BV160	BV016000	NR	VITE TSPEI PG DIN 7991 CL 10.9 M 4 X 16 Z.BIANCA	TSPEI PG SCREW DIN 7991 CL 10.9 M4 X 16 Z. WHITE	VIS DIN 7991 CL 10.9 M4 X 16 Z. WHITE	TSPEI PG SCHRAUBE DIN 7991 CL 10.9 M4 X 16 Z. WEIß	TORNILLO TSPEI PG DIN 7991 CL 10.9 M 4 X 16 GALVANIZADO BLANCO
BV162	BV016200	NR	VITE TCEI PG DIN 912 CL 12.9 M14 X 45 GEOMET 321A	SCREW DIN 912 CL 12.9 M14 X 45 GEOMET 321A	VIS TCEI PG DIN 912 CL 12.9 M14 X 45 GEOMET 321A	SCHRAUBE TCEI PG DIN 912 CL 12.9 M14 X 45 GEOMET 321A	TORNILLO TCEI PG DIN 912 CL 12.9 M14 X 45 GEOMET 321A
BV163	BV016300	NR	VITE TCEI PG DIN 912 CL 8.8 M6 X 35	SCREW DIN 912 CL 8.8 M6 X 35	VIS DIN 912 CL 8.8 M6 X 35	SCHRAUBE DIN 912 CL 8.8 M6 X 35	TORNILLO DIN 912 CL 8.8 M6 X 35
BV164	BV016400	NR	VITE TCEI PG DIN 912 CL 8.8 M10 X 35	SCREW DIN 912 CL 8.8 M10 X 35	VIS DIN 912 CL 8.8 M10 X 35	SCHRAUBE DIN 912 CL 8.8 M10 X 35	TORNILLO DIN 912 CL 8.8 M10 X 35
BV165	BV016500	NR	VITE TE TUTTO FILETTO PG DIN 933 CL 8.8 M8 X 12 Z.BIANCA	SCREW ALL THREAD DIN 933 PG CL 8.8 M8 X 12 Z. WHITE	VIS ENTIÈREMENT FILETÉE DIN 933 PG CL 8.8 M8 X 12 Z. BLANC	VOLLGEWINDESCHRAUBE DIN 933 PG CL 8.8 M8 X 12 Z. WEIß	TORNILLO TOTALMENTE ROSCADO PG DIN 933 CL 8.8 M8 X 12 GALVANIZADO BLANCO
BV166	BV016600	NR	VITE TCEI PG DIN 912 CL 8.8 M4 X 20 Z. BIANCA	SCREW DIN 912 CL 8.8 M4 X 20 Z. WITHE	VIS DIN 912 CL 8.8 M4 X 20	SCHRAUBE DIN 912 CL 8.8 M4 X 20	TORNILLO TCEI PG DIN 912 CL 8.8 M4 X 20
BV167	BV016700	NR	VITE TCEI PG DIN 912 CL 8.8 M4 X 20 GEOMET 321A	ALL PF THREAD HEX HEAD SCREW DIN 961 CL 8.8 M 12 X 1,25 X 30 Z.BIANCA	VIS ENTIÈREMENT FILETÉE DIN 961 CL 8.8 M 12 X 1,25 X 30 Z.BLANC	VOLLGEWINDESCHRAUBE DIN 961 CL 8.8 M 12 X 1,25 X 30 Z. WEIß	TORNILLO TOTALMENTE ROSCADO TCEI PG DIN 912 CL 8.8 M4 X 20 GEOMET 321A
BV168	BV016800	NR	VITE TE TUTTO FILETTO PF DIN 961 CL 8.8 M 10 X 1,25 X 30 Z.BIANCA	ALL PF THREAD HEX HEAD SCREW DIN 961 CL 8.8 M 10 X 1,25 X 30 Z.BIANCA	VIS ENTIÈREMENT FILETÉE DIN 961 CL 8.8 M 10 X 1,25 X 30 Z.BLANC	VOLLGEWINDESCHRAUBE DIN 961 CL 8.8 M 10 X 1,25 X 30 Z. WEIß	TORNILLO TOTALMENTE ROSCADO PF DIN 961 CL 8.8 M 10 X 1,25 X 30 GALVANIZADO BLANCO
BV169	BV016900	NR	VITE TCEI PG DIN 912 CL 8.8 M 10 X 1,25 X 30 ZINCATA BIANCA	SCREW DIN 912 CL 8.8 M10 X 1,25 X 30	VIS DIN 912 CL 8.8 M10 X 1,25 X 30	SCHRAUBE DIN 912 CL 8.8 M10 X 1,25 X 30	TORNILLO TCEI PG DIN 912 CL 8.8 M 10 X 1,25 X 30
BV170	BV017000	NR	VITE TE PARZIALE FILETTO PF DIN 960 CL 8.8 M 10 X 1,25 X 60 Z.BIANCA	PARTIAL PF THREAD HEX HEAD SCREW DIN 960 CL 8.8 M 10 X 1,25 X 60 Z.BIANCA	VIS FILETÉE DIN 960 CL 8.8 M 10 X 1,25 X 60 Z.BLANC	VOLLGEWINDESCHRAUBE DIN 960 CL 8.8 M 10 X 1,25 X 60 Z. WEIß	TORNILLO ROSCADO DIN 960 CL 8.8 M 10 X 1,25 X 30 GALVANIZADO BLANCO
BV171	BV017100	NR	VITE TE TUTTO FILETTO PF DIN 961 CL 10.9 M 12 X 1,25 X 25 Z.BIANCA	ALL PF THREAD HEX HEAD SCREW DIN 961 CL 10.9 M 12 X 1,25 X 25 Z.BIANCA	VIS ENTIÈREMENT FILETÉE DIN 961 CL 10.9 M 12 X 1,25 X 25 Z.BLANC	VOLLGEWINDESCHRAUBE DIN 961 CL 10.9 M 12 X 1,25 X 25 Z. WEIß	TORNILLO TOTALMENTE ROSCADO DIN 961 CL 10.9 M 12 X 1,25 X 25 GALVANIZADO BLANCO





POS	Codice	U.M.	 Descrizione	 Description	 Designation	 Benennung	 Descripción
BV172	BV017200	NR	VITE TCEI UNC ASME/ANSI B18.3 ASTM A 574 5/8 X 11/2 GEO 321A	VITE TCEI UNC ASME/ANSI B18.3 ASTM A 574 5/8 X 11/2 GEO 321A	VIS TCEI UNC ASME/ANSI B18.3 ASTM A 574 5/8 X 11/2 GEO 321A	SCHRAUBE TCEI UNC ASME/ANSI B18.3 ASTM A 574 5/8 X 11/2 GEO 321A	TORNILLO TCEI UNC ASME/ANSI B18.3 ASTM A 574 5/8 X 11/2 GEO 321A
BV173	BV017300	NR	VITE TE TUTTO FILETTO PG DIN 933 CL 8.8 M12 X 30 Z.BIANCA	SCREW ALL THREAD DIN 933 PG CL 8.8 M12 X 30 Z. WHITE	VIS ENTIÈREMENT FILETÉE DIN 933 PG CL 8.8 M12 X 30 Z. BLANC	VOLLGEWINDESCHRAUBE DIN 933 PG CL 8.8 M12 X 30 Z. WEIß	TORNILLO TOTALMENTE ROSCADO DIN 933 CL 8.8 M12 X 30 GALVANIZADO BLANCO
BV174	BV017400	NR	VITE TE TUTTO FILETTO PG DIN 933 CL 8.8 M5 X 45 Z.BIANCA	SCREW ALL THREAD DIN 933 PG CL 8.8 M5 X 45 Z. WHITE	VIS ENTIÈREMENT FILETÉE DIN 933 PG CL 8.8 M5 X 45 Z. BLANC	VOLLGEWINDESCHRAUBE DIN 933 PG CL 8.8 M5 X 45 Z. WEIß	TORNILLO TOTALMENTE ROSCADO DIN 933 CL 8.8 M5 X 45 GALVANIZADO BLANCO
BV175	BV017500	NR	VITE TE PARZIALE FILETTO PG DIN 931 CL 8.8 M 12 X 80 Z.BIANCA	SCREW PARTIAL THREAD DIN 931 PG CL 8.8 M12 X 80 Z. WHITE	VIS FILETÉE DIN 931 PG CL 8.8 M12 X 80 Z. BLANC	VOLLGEWINDESCHRAUBE DIN 931 PG CL 8.8 M12 X 80 Z. WEIßE	VIS ROSCADO DIN 931 CL 8.8 M12 X 80 GALVANIZADO BLANCO
BV176	BV017600	NR	VITE TCEI PG DIN 912 CL 8.8 M 6 X 25 Z.BIANCA	SCREW DIN 912 CL 8.8 M6 X 25	VIS DIN 912 CL 8.8 M6 X 25	SCHRAUBE DIN 912 CL 8.8 M6 X 25	TORNILLO TCEI PG DIN 912 CL 8.8 M6 X 25
BV177	BV017700	NR	VITE TE PARZIALE FILETTO PG DIN 931 CL 8.8 M 12 X 85 Z.BIANCA	SCREW PARTIAL THREAD DIN 931 PG CL 8.8 M12 X 85 Z. WHITE	VIS FILETÉE DIN 931 PG CL 8.8 M12 X 85 Z. BLANC	VOLLGEWINDESCHRAUBE DIN 931 PG CL 8.8 M12 X 85 Z. WEIßE	TORNILLO ROSCADO DIN 931 CL 8.8 M12 X 85 GALVANIZADO BLANCO
BV178	BV017800	NR	VITE TE TUTTO FILETTO PG DIN 933 CL 8.8 M8 X 90 Z.BIANCA	SCREW ALL THREAD DIN 933 PG CL 8.8 M8 X 90 Z. WHITE	VIS ENTIÈREMENT FILETÉE DIN 933 PG CL 8.8 M8 X 90 Z. BLANC	VOLLGEWINDESCHRAUBE DIN 933 PG CL 8.8 M8 X 90 Z. WEIßE	TORNILLO TOTALMENTE ROSCADO DIN 933 CL 8.8 M8 X 90 GALVANIZADO BLANCO
BV179	BV017900	NR	VITE TE TUTTO FILETTO PG DIN 933 CL 8.8 M5 X 40 Z.BIANCA	SCREW ALL THREAD DIN 933 PG CL 8.8 M5 X 40 Z. WHITE	VIS ENTIÈREMENT FILETÉE DIN 933 PG CL 8.8 M5 X 40 Z. BLANC	VOLLGEWINDESCHRAUBE DIN 933 PG CL 8.8 M5 X 40 Z. WEIßE	TORNILLO TOTALMENTE ROSCADO PG DIN 933 CL 8.8 M5 X 40 GALVANIZADO BLANCO
BV180	BV018000	NR	VITE TE TUTTO FILETTO PG DIN 933 CL 8.8 M6 X 75 Z.BIANCA	SCREW ALL THREAD DIN 933 PG CL 8.8 M6 X 75 Z. WHITE	VIS ENTIÈREMENT FILETÉE DIN 933 PG CL 8.8 M6 X 75 Z. BLANC	VOLLGEWINDESCHRAUBE DIN 933 PG CL 8.8 M6 X 75 Z. WEIß	TORNILLO TOTALMENTE ROSCADO DIN 933 CL 8.8 M6 X 75 GALVANIZADO BLANCO
BV182	BV018200	NR	VITE TE TUTTO FILETTO PG DIN 933 CL 10.9 M 16 X 70 Z.BIANCA	SCREW ALL THREAD DIN 933 PG CL 10.9 M 16 X 70 Z. WHITE	VIS ENTIÈREMENT FILETÉE DIN 933 CL 10.9 M 16 X 70 GALVANISÉE BLANCHE	VOLLGEWINDESCHRAUBE DIN 933 PG CL 10.9 M 16 X 70 Z. WEIß	TORNILLO TOTALMENTE FILETADO DIN 933 CL 10.9 M 16 X 70 TOTALMENTE ROSCADO
BV183	BV018300	NR	VITE TE TUTTO FILETTO PG DIN 933 CL 8.8 M5 X 10 Z.BIANCA	SCREW ALL THREAD DIN 933 PG CL 8.8 M5 X 10 Z. WHITE	VIS ENTIÈREMENT FILETÉE DIN 933 PG CL 8.8 M5 X 10 Z. BLANC	VOLLGEWINDESCHRAUBE DIN 933 PG CL 8.8 M5 X 10 Z. WEIß	TORNILLO TOTALMENTE ROSCADO DIN 933 CL 8.8 M5 X 10 GALVANIZADO BLANCO

POS	Codice	U.M.	 Descrizione	 Description	 Designation	 Benennung	 Descripción
BV184	BV018400	NR	VITE TE TUTTO FILETTO PG DIN 933 CL 8.8 M10 X 16 Z.BIANCA	SCREW ALL THREAD DIN 933 PG CL 8.8 M10 X 16 Z. WHITE	VIS ENTIÈREMENT FILETÉE DIN 933 PG CL 8.8 M10 X 16 Z. BLANC	VOLLGEWINDESCHRAUBE DIN 933 PG CL 8.8 M10 X 16 Z. WEIß	TORNILLO TOTALMENTE ROSCADO DIN 933 CL 8.8 M10 X 16 GALVANIZADO BLANCO
BV185	BV018500	NR	VITE TCEI PG DIN 912 CL 8.8 M 8 X 55 Z.BIANCA	SCREW DIN 912 CL 8.8 M8 X 55	VIS DIN 912 CL 8.8 M8 X 55	SCHRAUBE DIN 912 CL 8.8 M8 X 55	TORNILLO DIN 912 CL 8.8 M8 X 55
BV186	BV018600	NR	VITE TCEI PG DIN 912 CL 12.9 M10 X 30 GEOMET 321A	SCREW DIN 912 CL 12.9 M10 X 30 GEOMET 321A	VIS DIN 912 CL 12.9 M10 X 30 GEOMET 321A	SCHRAUBE DIN 912 CL 12.9 M10 X 30 GEOMET 321A	TORNILLO DIN 912 CL 12.9 M10 X 30 GEOMET 321A
BV187	BV018700	NR	VITE TCEI PG DIN 912 CL 12.9 M14 X 40 GEOMET 321A	SCREW DIN 912 CL 12.9 M14 X 40 GEOMET 321A	VIS TCEI PG DIN 912 CL 12.9 M14 X 40 GEOMET 321A	SCHRAUBE DIN 912 CL 12.9 M14 X 40 GEOMET 321A	TORNILLO DIN 912 CL 12.9 M14 X 40 GEOMET 321A
BV188	BV018800	NR	VITE TE TUTTO FILETTO PG DIN 933 CL 8.8 M 12 X 60 Z.BIANCA	SCREW ALL THREAD DIN 933 PG CL 8.8 M12 X 60 Z. WHITE	VIS ENTIÈREMENT FILETÉE DIN 933 PG CL 8.8 M12 X 60 Z. BLANC	VOLLGEWINDESCHRAUBE DIN 933 PG CL 8.8 M12 X 60 Z. WEIßE	VIS TOTALMENTE ROSCADO DIN 933 CL 8.8 M12 X 60 GALVANIZADO BLANCO
BV189	BV018900	NR	VITE TE TUTTO FILETTO PG DIN 933 CL 8.8 M 12 X 55 Z.BIANCA	SCREW ALL THREAD DIN 933 PG CL 8.8 M12 X 55 Z. WHITE	VIS ENTIÈREMENT FILETÉE DIN 933 PG CL 8.8 M12 X 55 Z. BLANC	VOLLGEWINDESCHRAUBE DIN 933 PG CL 8.8 M12 X 55 Z. WEIßE	VIS TOTALMENTE ROSCADO DIN 933 CL 8.8 M12 X 55 GALVANIZADO BLANCO
BV190	BV019000	NR	VITE TE TUTTO FILETTO PG DIN 933 CL 8.8 M 12 X 50 Z.BIANCA	SCREW ALL THREAD DIN 933 PG CL 8.8 M12 X 50 Z. WHITE	VIS ENTIÈREMENT FILETÉE DIN 933 PG CL 8.8 M12 X 50 Z. BLANC	VOLLGEWINDESCHRAUBE DIN 933 PG CL 8.8 M12 X 50 Z. WEIßE	VIS TOTALMENTE ROSCADO DIN 933 CL 8.8 M12 X 50 GALVANIZADO BLANCO
BV191	BV019100	NR	VITE TE TUTTO FILETTO PG DIN 933 CL 8.8 M 16 X 50 Z.BIANCA	SCREW ALL THREAD DIN 933 PG CL 8.8 M16 X 50 Z. WHITE	VIS ENTIÈREMENT FILETÉE DIN 933 PG CL 8.8 M16 X 50 Z. BLANC	VOLLGEWINDESCHRAUBE DIN 933 PG CL 8.8 M16 X 50 Z. WEIßE	VIS TOTALMENTE ROSCADO DIN 933 CL 8.8 M16 X 50 GALVANIZADO BLANCO
BV192	BV019200	NR	VITE TE TUTTO FILETTO PG DIN 933 CL 8.8 M 16 X 55 Z.BIANCA	SCREW ALL THREAD DIN 933 PG CL 8.8 M16 X 55 Z. WHITE	VIS ENTIÈREMENT FILETÉE DIN 933 PG CL 8.8 M16 X 55 Z. BLANC	VOLLGEWINDESCHRAUBE DIN 933 PG CL 8.8 M16 X 55 Z. WEIßE	VIS TOTALMENTE ROSCADO DIN 933 CL 8.8 M16 X 55 GALVANIZADO BLANCO
BV193	BV019300	NR	VITE TE PARZIALE FILETTO PG DIN 931 CL 8.8 M 10 X 55 Z.BIANCA	SCREW PARTIAL THREAD DIN 931 PG CL 8.8 M 10 X 55 Z. WHITE	VIS PARTIELLEMENT FILETÉE DIN 931 PG CL 8.8 M 10 X 55 Z. BLANC	TEILGEWINDESCHRAUBE DIN 931 PG CL 8.8 M 10 X 55 Z. WEIß	TORNILLO PARCIALMENTE ROSCADO PG DIN 931 CL 8.8 M 10 X 55 GALVANIZADO BLANCO
BV194	BV019400	NR	VITE TE PARZIALE FILETTO PG DIN 931 CL 8.8 M 16 X 230 Z.BIANCA	SCREW PARTIAL THREAD DIN 931 PG CL 8.8 M 16 X 230 Z. WHITE	VIS PARTIELLEMENT FILETÉE DIN 931 PG CL 8.8 M 16 X 230 Z. BLANC	TEILGEWINDESCHRAUBE DIN 931 PG CL 8.8 M 16 X 230 Z. WEIß	TORNILLO PARCIALMENTE ROSCADO PG DIN 931 CL 8.8 M 16 X 230 GALVANIZADO BLANCO





POS	Codice	U.M.	 Descrizione	 Description	 Designation	 Benennung	 Descripción
BV195	BV019500	NR	VITE TE PARZIALE FILETTO PG DIN 931 CL 8.8 M 6 X 50 Z.BIANCA	SCREW PARTIAL THREAD DIN 931 PG CL 8.8 M 6 X 50 Z. WHITE	VIS PARTIELLEMENT FILETÉE DIN 931 PG CL 8.8 M 6 X 50 Z. BLANC	TEILGEWINDESCHRAUBE DIN 931 PG CL 8.8 M 6 X 50 Z. WEIß	TORNILLO PARCIALMENTE ROSCADO PG DIN 931 CL 8.8 M 6 X 50 GALVANIZADO BLANCO
BV196	BV019600	NR	VITE TE PARZIALE FILETTO PG DIN 931 CL 8.8 M 6 X 65 Z.BIANCA	SCREW PARTIAL THREAD DIN 931 PG CL 8.8 M 6 X 65 Z. WHITE	VIS PARTIELLEMENT FILETÉE DIN 931 PG CL 8.8 M 6 X 65 Z. BLANC	TEILGEWINDESCHRAUBE DIN 931 PG CL 8.8 M 6 X 65 Z. WEIß	TORNILLO PARCIALMENTE ROSCADO PG DIN 931 CL 8.8 M 6 X 65 GALVANIZADO BLANCO
BV197	BV019700	NR	VITE TE PARZIALE FILETTO PG DIN 931 CL 8.8 M 8 X 45 Z.BIANCA	SCREW PARTIAL THREAD DIN 931 PG CL 8.8 M 8 X 45 Z. WHITE	VIS PARTIELLEMENT FILETÉE DIN 931 PG CL 8.8 M 8 X 45 Z. BLANC	TEILGEWINDESCHRAUBE DIN 931 PG CL 8.8 M 8 X 45 Z. WEIß	TORNILLO PARCIALMENTE ROSCADO PG DIN 931 CL 8.8 M 8 X 45 GALVANIZADO BLANCO
BV198	BV019800	NR	VITE TE PARZIALE FILETTO PG DIN 931 CL 8.8 M 8 X 55 Z.BIANCA	SCREW PARTIAL THREAD DIN 931 PG CL 8.8 M 8 X 55 Z. WHITE	VIS PARTIELLEMENT FILETÉE DIN 931 PG CL 8.8 M 8 X 55 Z. BLANC	TEILGEWINDESCHRAUBE DIN 931 PG CL 8.8 M 8 X 55 Z. WEIß	TORNILLO PARCIALMENTE ROSCADO PG DIN 931 CL 8.8 M 8 X 55 GALVANIZADO BLANCO
BV199	BV019900	NR	VITE TE PARZIALE FILETTO PG DIN 931 CL 8.8 M 8 X 60 Z.BIANCA	SCREW PARTIAL THREAD DIN 931 PG CL 8.8 M 8 X 60 Z. WHITE	VIS PARTIELLEMENT FILETÉE DIN 931 PG CL 8.8 M 8 X 60 Z. BLANC	TEILGEWINDESCHRAUBE DIN 931 PG CL 8.8 M 8 X 60 Z. WEIß	TORNILLO PARCIALMENTE ROSCADO PG DIN 931 CL 8.8 M 8 X 60 GALVANIZADO BLANCO
BV200	BV020000	NR	VITE TE TUTTO FILETTO PG DIN 933 CL 10.9 M 16 X 40	SCREW ALL THREAD DIN 933 PG CL 10.9 M 16 X 40	VIS ENTIÈREMENT FILETÉE DIN 933 CL 10.9 M 16 X 40	VOLLGEWINDESCHRAUBE DIN 933 PG CL 10.9 M 16 X 40	TORNILLO TOTALMENTE FILETADO DIN 933 CL 10.9 M 16 X 40
BV201	BV020100	NR	VITE TSPEI PG DIN 7991 CL 10.9 M16 X 45 Z.BIANCA	TSPEI PG SCREW DIN 7991 CL 10.9 M16 X 45 Z. WHITE	VIS DIN 7991 CL 10.9 M16 X 45 Z. WHITE	TSPEI PG SCHRAUBE DIN 7991 CL 10.9 M16 X 45 Z. WEIß	TORNILLO TSPEI PG DIN 7991 CL 10.9 M 16 X 45 GALVANIZADO BLANCO
BV202	BV020200	NR	VITE TCEI PG DIN 912 CL 12.9 M3 X 12 ZINC. IRIDESCENTE FE/ZN5IVS	SCREW DIN 912 CL 12.9 M3 X 12 ZINC. IRIDESCENTE FE/ZN5IVS	VIS DIN 912 CL 12.9 M3 X 12 ZINC. IRIDESCENTE FE/ZN5IVS	SCHRAUBE DIN 912 CL 12.9 M3 X 12 ZINC. IRIDESCENTE FE/ZN5IVS	TORNILLO DIN 912 CL 12.9 M3 X 12 ZINC. IRIDESCENTE FE/ZN5IVS
BV203	BV020300	NR	VITE TC CROCE PG DIN 7985 CL 4.8 M M 3 X 5 Z.BIANCA	SCREW DIN 7985 CL 4.8 M M 3 X 5	VIS CROIX DIN 7985 CL 4.8 M M 3 X 5 GALVANISATION BLANCHE	SCHRAUBE	TORNILLO
BV204	BV020400	NR	VITE TC CROCE PG DIN 7985 CL 4.8 M M 3 X 8 Z.BIANCA	SCREW DIN 7985 CL 4.8 M M 3 X 8	VIS CROIX DIN 7985 CL 4.8 M M 3 X 8 GALVANISATION BLANCHE	SCHRAUBE	TORNILLO
BV205	BV020500	NR	VITE TTQST DIN 603 CL 4.8 M 8 X 35 Z.BIANCA	TTQST SCREW DIN 603 CL 4.8 M 8 X 35 Z. WHITE			

POS	Codice	U.M.	 Descrizione	 Description	 Designation	 Benennung	 Descripción
BV206	BV020600	NR	VITE TC CROCE PG DIN 7985 CL 4.8 M M 5 X 80 Z.BIANCA	SCREW DIN 7985 CL 4.8 M M 5 X 80	VIS CROIX DIN 7985 CL 4.8 M M 5 X 80 GALVANISATION BLANCHE	SCHRAUBE	TORNILLO
BV207	BV020700	NR	VITE TE PARZIALE FILETTO PG DIN 931 CL 8.8 M 10 X 80 Z.BIANCA	SCREW PARTIAL THREAD DIN 931 PG CL 8.8 M 10 X 80 Z. WHITE	VIS PARTIELLEMENT FILETÉE DIN 931 PG CL 8.8 M 10 X 80 Z. BLANC	TEILGEWINDESCHRAUBE DIN 931 PG CL 8.8 M 10 X 80 Z. WEIß	TORNILLO PARCIALMENTE ROSCADO PG DIN 931 CL 8.8 M 10 X 80 GALVANIZADO BLANCO
BV208	BV020800	NR	VITE TE TUTTO FILETTO PG DIN 933 CL 8.8 M 16 X 35 Z.D.BIANCA	SCREW ALL THREAD DIN 933 PG CL 8.8 M 16 X 35 ZD WHITE	VIS ENTIÈREMENT FILETÉE DIN 933 CL 8.8 M 16 X 35 GALVANISATION BLANCHE	SCHRAUBE	TORNILLO
BV209	BV020900	NR	VITE TE PARZIALE FILETTO PG DIN 931 CL 8.8 M 10 X 95 Z.BIANCA	SCREW PARTIAL THREAD DIN 931 PG CL 8.8 M 10 X 95 Z. WHITE	VIS PARTIELLEMENT FILETÉE DIN 931 PG CL 8.8 M 10 X 95 Z. BLANC	TEILGEWINDESCHRAUBE DIN 931 PG CL 8.8 M 10 X 95 Z. WEIß	TORNILLO PARCIALMENTE ROSCADO PG DIN 931 CL 8.8 M 10 X 95 GALVANIZADO BLANCO
BV210	BV021000	NR	VITE TE TUTTO FILETTO PG DIN 933 CL 8.8 M 6 X 14 Z.D.BIANCA	SCREW ALL THREAD DIN 933 PG CL 8.8 M 6 X 14 ZD WHITE	VIS ENTIÈREMENT FILETÉE DIN 933 CL 8.8 M 6 X 14 GALVANISATION BLANCHE	SCHRAUBE	TORNILLO
BV211	BV021100	NR	VITE TE TUTTO FILETTO PG DIN 933 CL 8.8 M 12 X 25 Z.D.BIANCA	SCREW ALL THREAD DIN 933 PG CL 8.8 M 12 X 25 ZD WHITE	VIS ENTIÈREMENT FILETÉE DIN 933 CL 8.8 M 12 X 25 GALVANISATION BLANCHE	SCHRAUBE	TORNILLO
BV212	BV021200	NR	VITE TE TUTTO FILETTO PG DIN 933 CL 8.8 M 4 X 14 Z.D.BIANCA	SCREW ALL THREAD DIN 933 PG CL 8.8 M 4 X 14 ZD WHITE	VIS ENTIÈREMENT FILETÉE DIN 933 CL 8.8 M 4 X 14 GALVANISATION BLANCHE	SCHRAUBE	TORNILLO
BV213	BV021300	NR	VITE TE TUTTO FILETTO PG DIN 933 CL 10.9 M 16 X 60	SCREW ALL THREAD DIN 933 PG CL 10.9 M 16 X 60	VIS ENTIÈREMENT FILETÉE DIN 933 CL 10.9 M 16 X 60	SCHRAUBE	TORNILLO
BV214	BV021400	NR	VITE TE PARZIALE FILETTO PG DIN 931 CL 8.8 M 6 X 100 Z.BIANCA	SCREW PARTIAL THREAD DIN 931 PG CL 8.8 M 6 X 100 Z. WHITE	VIS PARTIELLEMENT FILETÉE DIN 931 PG CL 8.8 M 6 X 100 Z. BLANC	TEILGEWINDESCHRAUBE DIN 931 PG CL 8.8 M 6 X 100 Z. WEIß	TORNILLO PARCIALMENTE ROSCADO PG DIN 931 CL 8.8 M 6 X 100 GALVANIZADO BLANCO
BV215	BV021500	NR	VITE TE PARZIALE FILETTO PG DIN 931 CL 10.9 M 16 X 110	SCREW PARTIAL THREAD DIN 931 PG CL 10.9 M 16 X 110	VIS PARTIELLEMENT FILETÉE DIN 931 CL 10.9 M 16 X 110	SCHRAUBE	TORNILLO
BV216	BV021600	NR	VITE TE PARZIALE FILETTO PG DIN 931 CL 10.9 M 16 X 240 Z.D.BIANCA	SCREW PARTIAL THREAD DIN 931 PG CL 10.9 M 16 X 240 ZD WHITE	VIS PARTIELLEMENT FILETÉE DIN 931 CL 10.9 M 16 X 240 GALVANISATION BLANCHE	SCHRAUBE	TORNILLO

POS	Codice	U.M.	 Descrizione	 Description	 Designation	 Benennung	 Descripción
BV217	BV021700	NR	VITE TSPEI PG DIN 7991 CL 10.9 M 8 X 30 Z.BIANCA	TSPEI PG SCREW DIN 7991 CL 10.9 M8 X 30 Z. WHITE	VIS TSPEI PG DIN 7991 CL 10.9 M 8 X 30 GALVANISATION BLANCHE	SCHRAUBE	TORNILLO
BV218	BV021800	NR	VITE TSPEI PG DIN 7991 CL 10.9 M 5 X 6 Z.BIANCA	TSPEI PG SCREW DIN 7991 CL 10.9 M5 X 6 Z. WHITE	VIS TSPEI PG DIN 7991 CL 10.9 M 5 X 6 GALVANISATION BLANCHE	SCHRAUBE	TORNILLO
BV219	BV021900	NR	VITE TSPEI PG DIN 7991 CL 10.9 M 5 X 70 Z.BIANCA	TSPEI PG SCREW DIN 7991 CL 10.9 M5 X 70 Z. WHITE	VIS TSPEI PG DIN 7991 CL 10.9 M 5 X 70 GALVANISATION BLANCHE	SCHRAUBE	TORNILLO
BV220	BV022000	NR	VITE TSPEI PG DIN 7991 CL 10.9 M 12 X 35 Z.BIANCA	TSPEI PG SCREW DIN 7991 CL 10.9 M12 X 35 Z. WHITE	VIS TSPEI PG DIN 7991 CL 10.9 M 12 X 35 GALVANISATION BLANCHE	SCHRAUBE	TORNILLO
BV221	BV022100	NR	VITE TCEI PG DIN 912 CL 12.9 M10 X 20 GEOMET 321A	SCREW DIN 912 CL 12.9 M10 X 20 GEOMET 321A	VIS DIN 912 CL 12.9 M10 X 20 GEOMET 321A	SCHRAUBE DIN 912 CL 12.9 M10 X 20 GEOMET 321A	TORNILLO DIN 912 CL 12.9 M10 X 20 GEOMET 321A
BV222	BV022200	NR	VITE TCEI PG DIN 912 CL 12.9 M8 X 90 GEOMET 321A	SCREW DIN 912 CL 12.9 M8 X 90 GEOMET 321A	VIS DIN 912 CL 12.9 M8 X 90 GEOMET 321A	SCHRAUBE DIN 912 CL 12.9 M8 X 90 GEOMET 321A	TORNILLO DIN 912 CL 12.9 M8 X 90 GEOMET 321A
BV223	BV022300	NR	VITE TCEI PG DIN 912 CL 12.9 M3 X 5 ZINC.	SCREW DIN 912 CL 12.9 M3 X 5 ZINC.	VIS DIN 912 CL 12.9 M3 X 5 ZINC.	SCHRAUBE DIN 912 CL 12.9 M3 X 5 ZINC.	TORNILLO DIN 912 CL 12.9 M3 X 5 ZINC.
BV224	BV022400	NR	VITE TBEI PG ISO 7380 CL 10.9 M 8 X 22 Z.BIANCA	HEX SOCKET SCREW ISO 7380 PG CL 10.9 M 8 X 22 Z. WHITE	VIS ISO 7380 PG CL 10.9 M 8 X 22 Z. BLANC	SCHRAUBE ISO 7380 PG CL 10.9 M 8 X 22 Z. WEIß	TORNILLO TBEI PG ISO 7380 CL 10.9 M 8 X 22 GALVANIZADO BLANCO
BV225	BV022500	NR	VITE TE PARZIALE FILETTO PG DIN 931 CL 8.8 M 10 X 100 Z.BIANCA	SCREW PARTIAL THREAD DIN 931 PG CL 8.8 M 10 X 100 Z. WHITE	VIS PARTIELLEMENT FILETÉE DIN 931 PG CL 8.8 M 10 X 100 Z. BLANC	TEILGEWINDESCHRAUBE DIN 931 PG CL 8.8 M 10 X 100 Z. WEIß	TORNILLO PARCIALMENTE ROSCADO PG DIN 931 CL 8.8 M 10 X 100 GALVANIZADO BLANCO
BV226	BV022600	NR	VITE TE PARZIALE FILETTO PG DIN 931 CL 8.8 M 10 X 110 Z.BIANCA	SCREW PARTIAL THREAD DIN 931 PG CL 8.8 M 10 X 110 Z. WHITE	VIS PARTIELLEMENT FILETÉE DIN 931 PG CL 8.8 M 10 X 110 Z. BLANC	TEILGEWINDESCHRAUBE DIN 931 PG CL 8.8 M 10 X 110 Z. WEIß	TORNILLO PARCIALMENTE ROSCADO PG DIN 931 CL 8.8 M 10 X 110 GALVANIZADO BLANCO
BV227	BV022700	NR	VITE TE PARZIALE FILETTO PG DIN 931 CL 10.9 M 12 X 45 Z.D.BIANCA	SCREW PARTIAL THREAD DIN 931 PG CL 10.9 M 12 X 45 ZD WHITE	VIS PARTIEL FILETÉE DIN 931 CL 10.9 M 12 X 45 GALVANISATION BLANCHE	SCHRAUBE	TORNILLO

POS	Codice	U.M.	 Descrizione	 Description	 Designation	 Benennung	 Descripción
BV228	BV022800	NR	VITE TE TUTTO FILETTO PG DIN 933 CL 10.9 M 14 X 35 Z.D.BIANCA	SCREW ALL THREAD DIN 933 PG CL 10.9 M 14 X 35 ZD WHITE	VIS ENTIÈREMENT FILETÉE DIN 933 CL 10.9 M 14 X 35 GALVANISATION BLANCHE	SCHRAUBE	TORNILLO
BV229	BV022900	NR	VITE TSPEI PG DIN 7991 CL 10.9 M 12 X 30 Z.BIANCA	TSPEI PG SCREW DIN 7991 CL 10.9 M12 X 30 Z. WHITE	VIS TSPEI PG DIN 7991 CL 10.9 M 12 X 30 GALVANISATION BLANCHE	SCHRAUBE	TORNILLO
BV230	BV023000	NR	VITE TE FLANGIATA TUTTO FILETTO PG DIN 6921 CL 8.8 M 5 X 12 ZINCONICKEL NERO +SIGILLANTE	FLANGE SCREW ALL THREAD DIN 6921 PG CL 8.8 M 5 X 12 ZINCNICKEL BLACK +SEALANT	VIS	SCHRAUBE	TORNILLO
BV231	BV023100	NR	VITE TE FLANGIATA TUTTO FILETTO PG DIN 6921 CL 8.8 M 6 X 16 ZINCONICKEL NERO +SIGILLANTE	FLANGE SCREW ALL THREAD DIN 6921 PG CL 8.8 M 6 X 16 ZINCNICKEL BLACK +SEALANT	VIS	SCHRAUBE	TORNILLO
BV232	BV023200	NR	VITE TE TUTTO FILETTO PG DIN 933 CL 8.8 M 5 X 25 Z.D.BIANCA	SCREW ALL THREAD DIN 933 PG CL 8.8 M 5 X 25 ZD WHITE	VIS ENTIÈREMENT FILETÉE DIN 933 CL 8.8 M 5 X 25 GALVANISATION BLANCHE	SCHRAUBE	TORNILLO
BV233	BV023300	NR	VITE TE TUTTO FILETTO PG DIN 933 CL 8.8 M 8 X 130 Z.D.BIANCA	SCREW ALL THREAD DIN 933 PG CL 8.8 M 8 X 130 ZD WHITE	VIS ENTIÈREMENT FILETÉE DIN 933 CL 8.8 M 8 X 130 GALVANISATION BLANCHE	SCHRAUBE	TORNILLO
BV234	BV023400	NR	VITE TBEI PG ISO 7380 CL 10.9 M 10 X 30 Z.BIANCA	HEX SOCKET SCREW ISO 7380 PG CL 10.9 M 10 X 30 Z. WHITE	VIS ISO 7380 PG CL 10.9 M 10 X 30 Z. BLANC	SCHRAUBE ISO 7380 PG CL 10.9 M10 X 30 Z. WEIß	TORNILLO TBEI PG ISO 7380 CL 10.9 M 10 X 30 GALVANIZADO BLANCO
BV235	BV023500	NR	VITE TE TUTTO FILETTO PG DIN 933 CL 10.9 M 16 X 35 Z.D.BIANCA	SCREW ALL THREAD DIN 933 PG CL 10.9 M 16 X 35 ZD WHITE	VIS ENTIÈREMENT FILETÉE DIN 933 CL 10.9 M 16 X 35 GALVANISATION BLANCHE	SCHRAUBE	TORNILLO
BV236	BV023600	NR	VITE TE PARZIALE FILETTO PG DIN 931 CL 8.8 M 6 X 45 Z.BIANCA	SCREW PARTIAL THREAD DIN 931 PG CL 8.8 M 6 X 45 Z. WHITE	VIS PARTIELLEMENT FILETÉE DIN 931 PG CL 8.8 M 6 X 45 Z. BLANC	TEILGEWINDESCHRAUBE DIN 931 PG CL 8.8 M 6 X 45 Z. WEIß	TORNILLO PARCIALMENTE ROSCADO PG DIN 931 CL 8.8 M 6 X 45 GALVANIZADO BLANCO
BV237	BV023700	NR	VITE TE TUTTO FILETTO PG DIN 933 CL 10.9 M 12 X 30 Z.D.BIANCA	SCREW ALL THREAD DIN 933 PG CL 10.9 M 12 X 30 ZD WHITE	VIS ENTIÈREMENT FILETÉE DIN 933 CL 10.9 M 12 X 30 GALVANISATION BLANCHE	SCHRAUBE	TORNILLO

POS	Codice	U.M.	 Descrizione	 Description	 Designation	 Benennung	 Descripción
BV238	BV023800	NR	VITE TE PARZIALE FILETTO PG DIN 931 CL 8.8 M 16 X 90 Z.BIANCA	SCREW PARTIAL THREAD DIN 931 PG CL 8.8 M 16 X 90 Z. WHITE	VIS PARTIELLEMENT FILETÉE DIN 931 PG CL 8.8 M 16 X 90 Z. BLANC	TEILGEWINDESCHRAUBE DIN 931 PG CL 8.8 M 16 X 90 Z. WEIß	TORNILLO PARCIALMENTE ROSCADO PG DIN 931 CL 8.8 M 16 X 90 GALVANIZADO BLANCO
BV239	BV023900	NR	VITE TE PARZIALE FILETTO PG DIN 931 CL 8.8 M 12 X 65 Z.BIANCA	SCREW PARTIAL THREAD DIN 931 PG CL 8.8 M 12 X 65 Z. WHITE	VIS PARTIELLEMENT FILETÉE DIN 931 PG CL 8.8 M 12 X 65 Z. BLANC	TEILGEWINDESCHRAUBE DIN 931 PG CL 8.8 M 12 X 65 Z. WEIß	TORNILLO PARCIALMENTE ROSCADO PG DIN 931 CL 8.8 M 12 X 65 GALVANIZADO BLANCO
BV240	BV024000	NR	VITE TC CROCE PG DIN 7985 CL 4.8 M 5 X 20 Z.BIANCA	SCREW DIN 7985 CL 4.8 M 5 X 20	VIS CROIX DIN 7985 CL 4.8 M 5 X 20 GALVANISATION BLANCHE	SCHRAUBE	TORNILLO
BV241	BV024100	NR	VITE TSPEI PG DIN 7991 CL 10.9 M 10 X 35 Z.BIANCA	TSPEI PG SCREW DIN 7991 CL 10.9 M 10 X 35 Z. WHITE	VIS TSPEI PG DIN 7991 CL 10.9 M 10 X 35 GALVANISATION BLANCHE	SCHRAUBE	TORNILLO
BV242	BV024200	NR	VITE TSPEI PG DIN 7991 CL 10.9 M 6 X 12 Z.BIANCA	TSPEI PG SCREW DIN 7991 CL 10.9 M 6 X 12 Z. WHITE	VIS TSPEI PG DIN 7991 CL 10.9 M 6 X 12 GALVANISATION BLANCHE	SCHRAUBE	TORNILLO
BV243	BV024300	NR	VITE TE PARZIALE FILETTO PG DIN 931 CL 8.8 M 12 X 150 Z.BIANCA	SCREW PARTIAL THREAD DIN 931 PG CL 8.8 M 12 X 150 Z. WHITE	VIS PARTIELLEMENT FILETÉE DIN 931 PG CL 8.8 M 12 X 150 Z. BLANC	TEILGEWINDESCHRAUBE DIN 931 PG CL 8.8 M 12 X 150 Z. WEIß	TORNILLO PARCIALMENTE ROSCADO PG DIN 931 CL 8.8 M 12 X 150 GALVANIZADO BLANCO
BV244	BV024400	NR	VITE TCEI PG DIN 912 CL 8.8 M5 X 50 ZINGATA BIANCA	SCREW DIN 912 CL 8.8 M5 X 50	VIS DIN 912 CL 8.8 M5 X 50	SCHRAUBE DIN 912 CL 8.8 M5 X 50	TORNILLO DIN 912 CL 8.8 M5 X 50
BV245	BV024500	NR	VITE TE PARZIALE FILETTO PG DIN 931 CL 8.8 M 8 X 110 Z.BIANCA	SCREW PARTIAL THREAD DIN 931 PG CL 8.8 M 8 X 110 Z. WHITE	VIS PARTIELLEMENT FILETÉE DIN 931 PG CL 8.8 M 8 X 110 Z. BLANC	TEILGEWINDESCHRAUBE DIN 931 PG CL 8.8 M 8 X 110 Z. WEIß	TORNILLO PARCIALMENTE ROSCADO PG DIN 931 CL 8.8 M 8 X 110 GALVANIZADO BLANCO
BV246	BV024600	NR	VITE TE PARZIALE FILETTO PG DIN 931 CL 8.8 M 8 X 40 Z.BIANCA	SCREW PARTIAL THREAD DIN 931 PG CL 8.8 M 8 X 40 Z. WHITE	VIS PARTIELLEMENT FILETÉE DIN 931 PG CL 8.8 M 8 X 40 Z. BLANC	TEILGEWINDESCHRAUBE DIN 931 PG CL 8.8 M 8 X 40 Z. WEIß	TORNILLO PARCIALMENTE ROSCADO PG DIN 931 CL 8.8 M 8 X 40 GALVANIZADO BLANCO
BV247	BV024700	NR	VITE TE TUTTO FILETTO PG DIN 933 CL 8.8 M 5 X 50 Z.D.BIANCA	SCREW ALL THREAD DIN 933 PG CL 8.8 M 5 X 50 ZD WHITE	VIS ENTIÈREMENT FILETÉE DIN 933 CL 8.8 M 5 X 50 GALVANISATION BLANCHE	SCHRAUBE	TORNILLO
BV248	BV024800	NR	VITE TCEI PG DIN 912 CL 8.8 M5 X 18 Z. BIANCA	SCREW DIN 912 CL 8.8 M5 X 18 Z. WHITE	VIS DIN 912 CL 8.8 M5 X 18	SCHRAUBE DIN 912 CL 8.8 M5 X 18	TORNILLO DIN 912 CL 8.8 M5 X 18

POS	Codice	U.M.	 Descrizione	 Description	 Designation	 Benennung	 Descripción
BV249	BV024900	NR	VITE TSPEI PG DIN 7991 CL 10.9 M 5 X 65 Z.BIANCA	TSPEI PG SCREW DIN 7991 CL 10.9 M 5 X 65 Z. WHITE	VIS TSPEI PG DIN 7991 CL 10.9 M 5 X 65 GALVANISATION BLANCHE	SCHRAUBE	TORNILLO
BV251	BV025100	NR	VITE TSPEI PG DIN 7991 CL 10.9 M 8 X 35 Z.BIANCA	TSPEI PG SCREW DIN 7991 CL 10.9 M 8 X 35 Z. WHITE	VIS TSPEI PG DIN 7991 CL 10.9 M 8 X 35 GALVANISATION BLANCHE	SCHRAUBE	TORNILLO
BV252	BV025200	NR	VITE TE TUTTO FILETTO PG DIN 933 CL 10.9 M 12 X 40 Z.D.BIANCA	SCREW ALL THREAD DIN 933 PG CL 10.9 M 12 X 40 ZD WHITE	VIS ENTIÈREMENT FILETÉE DIN 933 CL 10.9 M 12 X 40 GALVANISATION BLANCHE	SCHRAUBE	TORNILLO
BV253	BV025300	NR	VITE TBEI PG ISO 7380 M 6 X 55 Z.BIANCA	HEX SOCKET SCREW ISO 7380 PG M 6 X 55 Z. WHITE	VIS ISO 7380 PG M 6 X 55 Z. BLANC	SCHRAUBE ISO 7380 PG M 6 X 55 Z. WEIß	TORNILLO TBEI PG ISO 7380 M 6 X 55 GALVANIZADO BLANCO
BV254	BV025400	NR	VITE TE TUTTO FILETTO PG DIN 933 CL 10.9 M 10 X 35 Z.D.BIANCA	SCREW ALL THREAD DIN 933 PG CL 10.9 M 10 X 35 ZD WHITE	VIS ENTIÈREMENT FILETÉE DIN 933 CL 10.9 M 10 X 35 GALVANISATION BLANCHE	SCHRAUBE	TORNILLO
BV255	BV025500	NR	VITE TE TUTTO FILETTO PG DIN 933 CL 12.9 M 14 X 55 Z.D.BIANCA	SCREW ALL THREAD DIN 933 PG CL 12.9 M 14 X 55 ZD WHITE	VIS ENTIÈREMENT FILETÉE DIN 933 CL 12.9 M 14 X 55 GALVANISATION BLANCHE	SCHRAUBE	TORNILLO
BV256	BV025600	NR	VITE TESTA SVASATA CROCE AUTOFILETTANTE 6 X 25	SCREW HEAD CROSS COUNTERSUNK SELF TAPPING 6 X 25			
BV257	BV025700	NR	VITE TE TUTTO FILETTO PG DIN 933 CL 8.8 M14 X 30 Z.BIANCA	SCREW ALL THREAD DIN 933 PG CL 8.8 M14 X 30 Z. WHITE	VIS ENTIÈREMENT FILETÉE DIN 933 PG CL 8.8 M14 X 30 Z. BLANC	VOLLGEWINDESCHRAUBE DIN 933 PG CL 8.8 M14 X 30 Z. WEIß	TORNILLO TOTALMENTE ROSCADO PG DIN 933 CL 8.8 M14 X 30 GALVANIZADO BLANCO
BV258	BV025800	NR	VITE TE TUTTO FILETTO PG DIN 933 CL 10.9 M 12 X 35 Z.D.BIANCA	SCREW ALL THREAD DIN 933 PG CL 10.9 M 12 X 35 ZD WHITE	VIS ENTIÈREMENT FILETÉE DIN 933 CL 10.9 M 12 X 35 GALVANISATION BLANCHE	SCHRAUBE	TORNILLO
BV259	BV025900	NR	VITE TE TUTTO FILETTO PG DIN 933 CL 8.8 M 16 X 45 Z.BIANCA	SCREW ALL THREAD DIN 933 PG CL 8.8 M16 X 45 Z. WHITE	VIS ENTIÈREMENT FILETÉE DIN 933 PG CL 8.8 M16 X 45 Z. BLANC	VOLLGEWINDESCHRAUBE DIN 933 PG CL 8.8 M16 X 45 Z. WEIßE	VIS TOTALMENTE ROSCADO DIN 933 CL 8.8 M16 X 45 GALVANIZADO BLANCO
BV260	BV026000	NR	VITE TCEI PG DIN 912 CL 10.9 M 12 X 30 ZINCATA BIANCA	SCREW DIN 912 CL 10.9 M 12 X 30	VIS DIN 912 CL 12.9 M 10 X 30	SCHRAUBE DIN 912 CL 10.9 M 12 X 30	TORNILLO TCEI PG DIN 912 CL 10.9 M 12 X 30
BV261	BV026100	NR	VITE TCEI PG DIN 912 CL 10.9 M 12 X 20 ZINCATA BIANCA	SCREW DIN 912 CL 10.9 M 12 X 20	VIS DIN 912 CL 12.9 M 10 X 20	SCHRAUBE DIN 912 CL 10.9 M 12 X 20	TORNILLO TCEI PG DIN 912 CL 10.9 M 12 X 20

POS	Codice	U.M.	 Descrizione	 Description	 Designation	 Benennung	 Descripción
BV262	BV026200	NR	VITE TCEI PG DIN 912 CL 12.9 M14 X 35 GEOMET 321A	SCREW DIN 912 CL 12.9 M14 X 35 GEOMET 321A	VIS TCEI PG DIN 912 CL 12.9 M14 X 35 GEOMET 321A	SCHRAUBE DIN 912 CL 12.9 M14 X 35 GEOMET 321A	TORNILLO DIN 912 CL 12.9 M14 X 35 GEOMET 321A
BV263	BV026300	NR	VITE TCEI PG DIN 912 CL 12.9 M14 X 3 GEOMET 321A	SCREW DIN 912 CL 12.9 M14 X 3 GEOMET 321A	VIS TCEI PG DIN 912 CL 12.9 M14 X 3 GEOMET 321A	SCHRAUBE DIN 912 CL 12.9 M14 X 3 GEOMET 321A	TORNILLO DIN 912 CL 12.9 M14 X 30 GEOMET 321A
BV264	BV026400	NR	VITE TSPEI PG DIN 7991 CL 10.9 M 12 X 25 Z.BIANCA	TSPEI PG SCREW DIN 7991 CL 10.9 M12 X 25 Z. WHITE	VIS TSPEI PG DIN 7991 CL 10.9 M 12 X 25 GALVANISATION BLANCHE	SCHRAUBE	TORNILLO
BV265	BV026500	NR	VITE TE PARZIALE FILETTO PG DIN 931 CL 10.9 M 16 X 180 GEOMET 321A	SCREW PARTIAL THREAD DIN 931 PG CL 10.9 M 16 X 180 GEOMET 321A	VIS PARTIELLEMENT FILETÉE DIN 931 CL 10.9 M 16 X 180 GEOMET 321A	SCHRAUBE	TORNILLO
BV266	BV026600	NR	VITE TE TUTTO FILETTO PG DIN 933 CL 8.8 M8 X 10 Z.BIANCA	SCREW ALL THREAD DIN 933 PG CL 8.8 M8 X 10 Z. WHITE	VIS ENTIÈREMENT FILETÉE DIN 933 PG CL 8.8 M8 X 10 Z. BLANC	VOLLGEWINDESCHRAUBE DIN 933 PG CL 8.8 M8 X 10 Z. WEIß	TORNILLO TOTALMENTE ROSCADO PG DIN 933 CL 8.8 M8 X 10 GALVANIZADO BLANCO
BV267	BV026700	NR	VITE TCEI PG DIN 912 CL 8.8 M 12 X 40	SCREW DIN 912 CL 9.8 M 12 X 40	VIS DIN 912 CL 8.8 M 12 X 40	SCHRAUBE DIN 912 CL 8.8 M 12 X 40	TORNILLO DIN 912 CL 8.8 M 12 X 40
BV268	BV026800	NR	VITE TE PARZIALE FILETTO PG DIN 931 CL 8.8 M 12 X 140 Z.BIANCA	SCREW PARTIAL THREAD DIN 931 PG CL 8.8 M 12 X 140 Z. WHITE	VIS PARTIELLEMENT FILETÉE DIN 931 PG CL 8.8 M 12 X 140 Z. BLANC	TEILGEWINDESCHRAUBE DIN 931 PG CL 8.8 M 12 X 140 Z. WEIß	TORNILLO PARCIALMENTE ROSCADO PG DIN 931 CL 8.8 M 12 X 140 GALVANIZADO BLANCO
BV269	BV026900	NR	VITE TC CROCE PG DIN 7985 CL 4.8 M 6 X 25 Z.BIANCA	SCREW DIN 7985 CL 4.8 M 6 X 25	VIS CROIX DIN 7985 CL 4.8 M 6 X 25 GALVANISATION BLANCHE	SCHRAUBE	TORNILLO
BV270	BV027000	NR	VITE TCEI PG DIN 912 CL 8.8 M 12 X 40	SCREW DIN 912 CL 9.8 M 12 X 40	VIS DIN 912 CL 8.8 M 12 X 40	SCHRAUBE DIN 912 CL 8.8 M 12 X 40	TORNILLO DIN 912 CL 8.8 M 12 X 40
BV271	BV027100	NR	TCEI UNC ASME/ANSI B18.3 ASTM A 574 1/2 X 1"1/4 GEOMET	TCEI UNC ASME/ANSI B18.3 ASTM A 574 1/2 X 1"1/4 GEOMET	TCEI UNC ASME/ANSI B18.3 ASTM A 574 1/2 X 1"1/4 GEOMET	TCEI UNC ASME/ANSI B18.3 ASTM A 574 1/2 X 1"1/4 GEOMET	TCEI UNC ASME/ANSI B18.3 ASTM A 574 1/2 X 1"1/4 GEOMET
BV272	BV027200	NR	TCEI UNC ASME/ANSI B18.3 ASTM A 574 1/4-20 X 1"1/2 GEOMET	TCEI UNC ASME/ANSI B18.3 ASTM A 574 1/4-20 X 1"1/2 GEOMET	TCEI UNC ASME/ANSI B18.3 ASTM A 574 1/4-20 X 1"1/2 GEOMET	TCEI UNC ASME/ANSI B18.3 ASTM A 574 1/4-20 X 1"1/2 GEOMET	TCEI UNC ASME/ANSI B18.3 ASTM A 574 1/4-20 X 1"1/2 GEOMET
BV273	BV027300	NR	VITE TE PARZIALE FILETTO PG DIN 931 CL 8.8 M 12 X 70 Z.BIANCA	SCREW PARTIAL THREAD DIN 931 PG CL 8.8 M 12 X 70 Z. WHITE	VIS PARTIELLEMENT FILETÉE DIN 931 PG CL 8.8 M 12 X 70 Z. BLANC	TEILGEWINDESCHRAUBE DIN 931 PG CL 8.8 M 12 X 70 Z. WEIß	TORNILLO PARCIALMENTE ROSCADO PG DIN 931 CL 8.8 M 12 X 70 GALVANIZADO BLANCO



POS	Codice	U.M.	 Descrizione	 Description	 Designation	 Benennung	 Descripción
BV274	BV027400	NR	VITE TE TUTTO FILETTO PG DIN 933 CL 8.8 M 5 X 20 Z.D.BIANCA	SCREW ALL THREAD DIN 933 PG CL 8.8 M 5 X 20 ZD WHITE	VIS ENTIÈREMENT FILETÉE DIN 933 CL 8.8 M 5 X 20 GALVANISATION BLANCHE	SCHRAUBE	TORNILLO
BV275	BV027500	NR	VITE TSPEI PG DIN 7991 CL 10.9 M 6 X 70 Z.BIANCA	TSPEI PG SCREW DIN 7991 CL 10.9 M 6 X 70 Z. WHITE	VIS DIN 7991 CL 10.9 M 6 X 70 Z. BLANC	TSPEI PG SCHRAUBE DIN 7991 CL 10.9 M 6 X 70 Z. WEIß	TORNILLO TSPEI PG DIN 7991 CL 10.9 M 6 X 70 GALVANIZADO BLANCO
BV276	BV027600	NR	VITE TCEI PG DIN 912 CL 8.8 M 5 X 14 Z.BIANCA	SCREW DIN 912 PG CL 8.8 M 5 X 14 Z. WHITE	VIS DIN 912 CL 8.8 M 5 X 14 GALVANISATION BLANCHE	SCHRAUBE	TORNILLO
BV277	BV027700	NR	VITE TBEI PG ISO 7380 CL 10.9 M 10 X 35 Z.BIANCA	HEX SOCKET SCREW ISO 7380 PG CL 10.9 M 10 X 35 Z. WHITE	VIS ISO 7380 PG CL 10.9 M 10 X 35 Z. BLANC	SCHRAUBE ISO 7380 PG CL 10.9 M 10 X 35 Z. WEIß	TORNILLO TBEI PG ISO 7380 CL 10.9 M 10 X 35 GALVANIZADO BLANCO
BV278	BV027800	NR	VITE TE PARZIALE FILETTO PG DIN 931 CL 10.9 M 16 X 60	SCREW PARTIAL THREAD DIN 931 PG CL 10.9 M 16 X 60	VIS TE PARTIELLEMENT FILETÉE PG DIN 931 CL 10.9 M 16 X 60	TEILGEWINDESCHRAUBE DIN 931 PG CL 10.9 M 16 X 60	TORNILLO PARCIALMENTE ROSCADO PG DIN 931 CL 10.9 M 16 X 60
BV279	BV027900	NR	VITE TE PARZIALE FILETTO PG DIN 931 CL 8.8 M 12 X 60 Z.BIANCA	SCREW PARTIAL THREAD DIN 931 PG CL 8.8 M 12 X 60 Z. WHITE	VIS PARTIELLEMENT FILETÉE DIN 931 PG CL 8.8 M 12 X 60 Z. BLANC	TEILGEWINDESCHRAUBE DIN 931 PG CL 8.8 M 12 X 60 Z. WEIß	TORNILLO PARCIALMENTE ROSCADO PG DIN 931 CL 8.8 M 12 X 60 GALVANIZADO BLANCO
BV280	BV028000	NR	VITE TE PARZIALE FILETTO PG DIN 931 CL 8.8 M 12 X 55 Z.BIANCA	SCREW PARTIAL THREAD DIN 931 PG CL 8.8 M 12 X 55 Z. WHITE	VIS PARTIELLEMENT FILETÉE DIN 931 PG CL 8.8 M 12 X 55 Z. BLANC	TEILGEWINDESCHRAUBE DIN 931 PG CL 8.8 M 12 X 55 Z. WEIß	TORNILLO PARCIALMENTE ROSCADO PG DIN 931 CL 8.8 M 12 X 55 GALVANIZADO BLANCO
BV281	BV028100	NR	VITE TE PARZIALE FILETTO PG DIN 931 CL 8.8 M 14 X 45 Z.BIANCA	SCREW PARTIAL THREAD DIN 931 PG CL 8.8 M 14 X 45 Z. WHITE	VIS PARTIELLEMENT FILETÉE DIN 931 PG CL 8.8 M 14 X 45 Z. BLANC	TEILGEWINDESCHRAUBE DIN 931 PG CL 8.8 M 14 X 45 Z. WEIß	TORNILLO PARCIALMENTE ROSCADO PG DIN 931 CL 8.8 M 14 X 45 GALVANIZADO BLANCO
BV282	BV028200	NR	VITE TE TUTTO FILETTO PG DIN 933 CL 8.8 M 8 X 55 Z.BIANCA	SCREW ALL THREAD DIN 933 PG CL 8.8 M 8 X 55 Z. WHITE	VIS TE ENTIÈREMENT FILETÉE PG DIN 933 CL 8.8 M 8 X 55 Z.BLANC	VOLLGEWINDESCHRAUBE DIN 933 PG CL 8.8 M 8 X 55 Z. WEIß	TORNILLO TOTALMENTE ROSCADO PG DIN 933 CL 8.8 M 8 X 55 GALVANIZADO BLANCO
BV283	BV028300	NR	VITE TCEI INTERAMENTE FILETTATA PG CL 8.8 M 8 X 45 Z.BIANCA	SCREW TCEI FULLY THREADED PG CL 8.8 M 8 X 45 Z. WHITE	VIS	SCHRAUBE	TORNILLO
BV284	BV028400	NR	VITE TCEI PG DIN 912 CL 8.8 M 4 X 35 Z.BIANCA	SCREW TCEI DIN 912 CL 8.8 M 4 X 35 Z. WHITE	VIS	SCHRAUBE	TORNILLO





POS	Codice	U.M.	 Descrizione	 Description	 Designation	 Benennung	 Descripción
BV285	BV028500	NR	VITE TCEI PG DIN 912 CL 8.8 M 4 X 50 Z.BIANCA	SCREW TCEI DIN 912 CL 8.8 M 4 X 50 Z. WHITE	VIS	SCHRAUBE	TORNILLO
BV286	BV028600	NR	VITE TCEI PG DIN 912 CL 8.8 M 5 X 25 Z.BIANCA	SCREW TCEI DIN 912 CL 8.8 M 5 X 25 Z. WHITE	VIS	SCHRAUBE	TORNILLO
BV287	BV028700	NR	VITE TCEI PG DIN 912 CL 8.8 M 5 X 50 GEO 321 A	SCREW TCEI DIN 912 CL 8.8 M 5 X 50 GEO 321 A	VIS	SCHRAUBE	TORNILLO
BV293	BV029300	NR	VITE TCEI PG DIN 912 CL 8.8 M 8 X 90 Z.BIANCA	SCREW TCEI DIN 912 CL 8.8 M 8 X 90 Z. WHITE	VIS	SCHRAUBE	TORNILLO
BV294	BV029400	NR	VITE TCEI PG DIN 912 CL 8.8 M 10 X 16 Z.BIANCA	SCREW TCEI DIN 912 CL 8.8 M 10 X 16 Z. WHITE	VIS	SCHRAUBE	TORNILLO
BV295	BV029500	NR	VITE TCEI PG DIN 912 CL 8.8 M 10 X 20 Z.BIANCA	SCREW TCEI DIN 912 CL 8.8 M 10 X 20 Z. WHITE	VIS	SCHRAUBE	TORNILLO
BV297	BV029700	NR	VITE TCEI PG DIN 912 CL 8.8 M 10 X 40 Z.BIANCA	SCREW TCEI DIN 912 CL 8.8 M 10 X 40 Z. WHITE	VIS	SCHRAUBE	TORNILLO
BV298	BV029800	NR	VITE TCEI PG DIN 912 CL 8.8 M 10 X 65 Z.BIANCA	SCREW TCEI DIN 912 CL 8.8 M 10 X 65 Z. WHITE	VIS	SCHRAUBE	TORNILLO
BV299	BV029900	NR	VITE TCEI PG DIN 912 CL 8.8 M 10 X 120 Z.BIANCA	SCREW TCEI DIN 912 CL 8.8 M 10 X 120 Z. WHITE	VIS	SCHRAUBE	TORNILLO
BV300	BV030000	NR	VITE TCEI PG DIN 912 CL 8.8 M 12 X 30 Z.BIANCA	VITE TCEI PG DIN 912 CL 8.8 M 12 X 30 Z.BIANCA	VIS	SCHRAUBE	TORNILLO
BV301	BV030100	NR	VITE TCEI UNC ASME/ANSI B18.3 ASTM A 574 1/4 X 1"3/4	TCEI SCREW UNC ASME / ANSI B18.3 ASTM A 574 1/4 X 1 "3/4	VIS	SCHRAUBE	TORNILLO
BV303	BV030300	NR	VITE TCEI UNC ASME/ANSI B18.3 ASTM A 574 5/16 X 3/4	TCEI SCREW UNC ASME / ANSI B18.3 ASTM A 574 5/16 X 3/4	VIS	SCHRAUBE	TORNILLO
BV304	BV030400	NR	VITE TCEI PG DIN 912 CL 12.9 M 10 X 75	SCREW TCEI DIN 912 CL 12.9 M 10 X 75	VIS	SCHRAUBE	TORNILLO
BV305	BV030500	NR	VITE TCEI PG DIN 912 CL 12.9 M 14 X 55	SCREW TCEI DIN 912 CL 12.9 M 14 X 55	VIS	SCHRAUBE	TORNILLO
BV306	BV030600	NR	VITE TCEI BASSA PG DIN 7984 CL 10.9 M 12 X 20 Z.D.BIANCA	LOW TCEI SCREW DIN 7984 CL 10.9 M 12 X 20 Z.D. WHITE	VIS	SCHRAUBE	TORNILLO

POS	Codice	U.M.	 Descrizione	 Description	 Designation	 Benennung	 Descripción
BV307	BV030700	NR	VITE TSPEI TUTTO FILETTO PG DIN 7991 CL 10.9 M 12 X 90 ZIC. BIANCO DEID.	TSPEI SCREW FULLY THREADED DIN 7991 CL 10.9 M 12 X 90 ZIC. DEID WHITE.	VIS	SCHRAUBE	TORNILLO
BV308	BV030800	NR	VITE TSPEI TUTTO FIL. PG DIN 7991 CL 10.9 M 14 X 100 ZIC. BIANCO DEID.	TSPEI SCREW ALL THREAD DIN 7991 CL 10.9 M 14 X 100 ZIC. DEID WHITE.	VIS	SCHRAUBE	TORNILLO
BV309	BV030900	NR	VITE TSPEI PG DIN 7991 CL 10.9 M 4 X 25 ZIC. BIANCO DEID.	SCREW TSPEI DIN 7991 CL 10.9 M 4 X 25 ZIC. DEID WHITE.	VIS	SCHRAUBE	TORNILLO
BV310	BV031000	NR	VITE TSPEI PG DIN 7991 CL 10.9 M 5 X 40	SCREW TSPEI DIN 7991 CL 10.9 M 5 X 40	VIS	SCHRAUBE	TORNILLO
BV311	BV031100	NR	VITE TSPEI PG DIN 7991 CL 10.9 M 5 X 80 ZIC. BIANCO DEID.	SCREW TSPEI DIN 7991 CL 10.9 M 5 X 80 ZIC. DEID WHITE.	VIS	SCHRAUBE	TORNILLO
BV312	BV031200	NR	VITE TSPEI PG DIN 7991 CL 10.9 M 8 X 20 ZIC. BIANCO DEID.	SCREW TSPEI DIN 7991 CL 10.9 M 8 X 20 ZIC. DEID WHITE.	VIS	SCHRAUBE	TORNILLO
BV313	BV031300	NR	VITE TSPEI PG DIN 7991 CL 10.9 M 16 X 50 ZIC. BIANCO DEID.	SCREW TSPEI DIN 7991 CL 10.9 M 16 X 50 ZIC. DEID WHITE.	VIS	SCHRAUBE	TORNILLO
BV315	BV031500	NR	VITE TE UNC ANSI B18.2.1 GR.5 5/8 X 3 1/2	SCREW TE UNC ANSI B18.2.1 GR.5 5/8 X 3 1/2 "	VIS	SCHRAUBE	TORNILLO
BV316	BV031600	NR	VITE TE TUTTO FILETTO PG DIN 933 CL 8.8 M 4 X 40 Z.BIANCA	ALL SCREW TE THREAD DIN 933 CL 8.8 M 4 X 40 Z. WHITE	VIS	SCHRAUBE	TORNILLO
BV317	BV031700	NR	VITE TE TUTTO FILETTO PG DIN 933 CL 8.8 M 5 X 55 Z.BIANCA	ALL SCREW TE THREAD DIN 933 CL 8.8 M 5 X 55 Z. WHITE	VIS	SCHRAUBE	TORNILLO
BV318	BV031800	NR	VITE TE TUTTO FILETTO PG DIN 933 CL 8.8 M 6 X 10 Z.BIANCA	ALL SCREW TE THREAD DIN 933 CL 8.8 M 6 X 10 Z. WHITE	VIS	SCHRAUBE	TORNILLO
BV319	BV031900	NR	VITE TE TUTTO FILETTO PG DIN 933 CL 8.8 M 6 X 50 Z.BIANCA	ALL SCREW TE THREAD DIN 933 CL 8.8 M 6 X 50 Z. WHITE	VIS	SCHRAUBE	TORNILLO
BV320	BV032000	NR	VITE TE TUTTO FILETTO PG DIN 933 CL 8.8 M 8 X 45 Z.BIANCA	ALL SCREW TE THREAD DIN 933 CL 8.8 M 8 X 45 Z. WHITE	VIS	SCHRAUBE	TORNILLO

POS	Codice	U.M.	 Descrizione	 Description	 Designation	 Benennung	 Descripción
BV321	BV032100	NR	VITE TE TUTTO FILETTO PG DIN 933 CL 8.8 M 8 X 65 Z.BIANCA	ALL SCREW TE THREAD DIN 933 CL 8.8 M 8 X 65 Z. WHITE	VIS	SCHRAUBE	TORNILLO
BV322	BV032200	NR	VITE TE TUTTO FILETTO PG DIN 933 CL 8.8 M 8 X 80 Z.BIANCA	ALL SCREW TE THREAD DIN 933 CL 8.8 M 8 X 80 Z. WHITE	VIS	SCHRAUBE	TORNILLO
BV323	BV032300	NR	VITE TE TUTTO FILETTO PG DIN 933 CL 8.8 M 10 X 75 Z.BIANCA	ALL SCREW TE THREAD DIN 933 CL 8.8 M 10 X 75 Z. WHITE	VIS	SCHRAUBE	TORNILLO
BV324	BV032400	NR	VITE TE TUTTO FILETTO PG DIN 933 CL 8.8 M 12 X 75 Z.BIANCA	ALL SCREW TE THREAD DIN 933 CL 8.8 M 12 X 75 Z. WHITE	VIS	SCHRAUBE	TORNILLO
BV326	BV032600	NR	VITE TE PARZIALE FILETTO PG DIN 931 CL 8.8 M 8 X 90 Z.BIANCA	SCREW TE PARTIAL THREAD DIN 931 CL 8.8 M 8 X 90 Z. WHITE	VIS	SCHRAUBE	TORNILLO
BV327	BV032700	NR	VITE TE PARZIALE FILETTO PG DIN 931 CL 8.8 M 8 X 100 Z.BIANCA	SCREW TE PARTIAL THREAD DIN 931 CL 8.8 M 8 X 100 Z. WHITE	VIS	SCHRAUBE	TORNILLO
BV329	BV032900	NR	VITE TE PARZIALE FILETTO PG DIN 931 CL 8.8 M 10 X 40 Z.BIANCA	SCREW TE PARTIAL THREAD DIN 931 CL 8.8 M 10 X 40 Z. WHITE	VIS	SCHRAUBE	TORNILLO
BV330	BV033000	NR	VITE TE PARZIALE FILETTO PG DIN 931 CL 8.8 M 10 X 45 Z.BIANCA	SCREW TE PARTIAL THREAD DIN 931 CL 8.8 M 10 X 45 Z. WHITE	VIS	SCHRAUBE	TORNILLO
BV331	BV033100	NR	VITE TE PARZIALE FILETTO PG DIN 931 CL 8.8 M 10 X 60 Z.BIANCA	SCREW TE PARTIAL THREAD DIN 931 CL 8.8 M 10 X 60 Z. WHITE	VIS	SCHRAUBE	TORNILLO
BV332	BV033200	NR	VITE TE PARZIALE FILETTO PG DIN 931 CL 8.8 M 12 X 40 Z.BIANCA	SCREW TE PARTIAL THREAD DIN 931 CL 8.8 M 12 X 40 Z. WHITE	VIS	SCHRAUBE	TORNILLO
BV333	BV033300	NR	VITE TE PARZIALE FILETTO PG DIN 931 CL 8.8 M 12 X 45 Z.BIANCA	SCREW TE PARTIAL THREAD DIN 931 CL 8.8 M 12 X 45 Z. WHITE	VIS	SCHRAUBE	TORNILLO

POS	Codice	U.M.	 Descrizione	 Description	 Designation	 Benennung	 Descripción
BV334	BV033400	NR	VITE TE PARZIALE FILETTO PG DIN 931 CL 8.8 M 12 X 50 Z.BIANCA	SCREW TE PARTIAL THREAD DIN 931 CL 8.8 M 12 X 50 Z. WHITE	VIS	SCHRAUBE	TORNILLO
BV337	BV033700	NR	VITE TE PARZIALE FILETTO PG DIN 931 CL 8.8 M 14 X 60 Z.BIANCA	SCREW TE PARTIAL THREAD DIN 931 CL 8.8 M 14 X 60 Z. WHITE	VIS	SCHRAUBE	TORNILLO
BV338	BV033800	NR	VITE TE PARZIALE FILETTO PG DIN 931 CL 8.8 M 14 X 120 Z.BIANCA	SCREW TE PARTIAL THREAD DIN 931 CL 8.8 M 14 X 120 Z. WHITE	VIS	SCHRAUBE	TORNILLO
BV339	BV033900	NR	VITE TE PARZIALE FILETTO PG DIN 931 CL 8.8 M 16 X 50 Z.BIANCA	SCREW TE PARTIAL THREAD DIN 931 CL 8.8 M 16 X 50 Z. WHITE	VIS	SCHRAUBE	TORNILLO
BV340	BV034000	NR	VITE TE PARZIALE FILETTO PG DIN 931 CL 8.8 M 16 X 65 Z.BIANCA	SCREW TE PARTIAL THREAD DIN 931 CL 8.8 M 16 X 65 Z. WHITE	VIS	SCHRAUBE	TORNILLO
BV341	BV034100	NR	VITE TE TUTTO FILETTO PF DIN 961 CL 8.8 M 8 X 1 X 35 Z.BIANCA	ALL SCREW TE THREAD DIN 961 CL 8.8 M 8 X 1 X 35 Z. WHITE	VIS	SCHRAUBE	TORNILLO
BV342	BV034200	NR	VITE TE TUTTO FILETTO PF DIN 961 CL 8.8 M 20 X 1,5 X 35 Z.BIANCO	ALL SCREW TE THREAD DIN 961 CL 8.8 M 20 X 1.5 X 35 Z. WHITE	VIS	SCHRAUBE	TORNILLO
BV344	BV034400	NR	VITE TE TUTTO FILETTO PG DIN 933 CL 10.9 M 10 X 30 Z.D.BIANCA	ALL SCREW TE THREAD DIN 933 CL 10.9 M 10 X 30 Z.D. WHITE	VIS	SCHRAUBE	TORNILLO
BV346	BV034600	NR	VITE TE TUTTO FILETTO PG DIN 933 CL 10.9 M 16 X 65 GEO 321 A	ALL SCREW TE THREAD DIN 933 CL 10.9 M 16 X 65 GEO 321 A	VIS	SCHRAUBE	TORNILLO
BV347	BV034700	NR	VITE TE PARZIALE FILETTO PG DIN 931 CL 10.9 M 12 X 40 Z.D.BIANCA	SCREW TE PARTIAL THREAD DIN 931 CL 10.9 M 12 X 40 Z.D. WHITE	VIS	SCHRAUBE	TORNILLO
BV348	BV034800	NR	VITE TE PARZIALE FILETTO PG DIN 931 CL 10.9 M 12 X 75 Z.D.BIANCA	SCREW TE PARTIAL THREAD DIN 931 CL 10.9 M 12 X 75 Z.D. WHITE	VIS	SCHRAUBE	TORNILLO

POS	Codice	U.M.	 Descrizione	 Description	 Designation	 Benennung	 Descripción
BV349	BV034900	NR	VITE TE PARZIALE FILETTO PG DIN 931 CL 10.9 M 16 X 45 Z.D.BIANCA	SCREW TE PARTIAL THREAD DIN 931 CL 10.9 M 16 X 45 Z.D. WHITE	VIS	SCHRAUBE	TORNILLO
BV350	BV035000	NR	VITE TE PARZIALE FILETTO PG DIN 931 CL 10.9 M 16 X 75 Z.D.BIANCA	SCREW TE PARTIAL THREAD DIN 931 CL 10.9 M 16 X 75 Z.D. WHITE	VIS	SCHRAUBE	TORNILLO
BV351	BV035100	NR	VITE TE PARZIALE FILETTO PG DIN 931 CL 10.9 M 16 X 180	SCREW TE PARTIAL THREAD DIN 931 CL 10.9 M 16 X 180	VIS	SCHRAUBE	TORNILLO
BV352	BV035200	NR	VITE TE PARZIALE FILETTO PG DIN 931 CL 10.9 M 16 X 230 GEO 321 A	SCREW TE PARTIAL THREAD DIN 931 CL 10.9 M 16 X 230 GEO 321 A	VIS	SCHRAUBE	TORNILLO
BV354	BV035400	NR	VITE TE TUTTO FILETTO PF DIN 961 CL 10.9 M 12 X 1,25 X 35 Z.D.BIANCA	ALL SCREW TE THREAD DIN 961 CL 10.9 M 12 X 1.25 X 35 Z.D. WHITE	VIS	SCHRAUBE	TORNILLO
BV355	BV035500	NR	VITE TC CROCE PG DIN 7985 CL 4.8 M 4 X 10 Z.BIANCA	SCREW TC DIN 7985 CROSS CL 4.8 M 4 X 10 Z. WHITE	VIS	SCHRAUBE	TORNILLO
BV356	BV035600	NR	VITE TC CROCE PG DIN 7985 CL 4.8 M 5 X 22 Z.BIANCA	SCREW TC DIN 7985 CROSS CL 4.8 M 5 X 22 Z. WHITE	VIS	SCHRAUBE	TORNILLO
BV359	BV035900	NR	VITE TE 8.8 ZINCATE M 6 X 65 PARZIALE	SCREW TE 8.8 GALVANIZED M 6 X 65 PARTIAL	VIS	SCHRAUBE	TORNILLO
BV360	BV036000	NR	VITE TE 8.8 ZINCATE M 14 X 65 PARZIALE	SCREW TE 8.8 GALVANIZED M 14 X 65 PARTIAL	VIS	SCHRAUBE	TORNILLO
BV361	BV036100	NR	VITE TBEI PG ISO 7380 CL 10.9 M 5 X 20 Z.BIANCA	HEX SOCKET SCREW ISO 7380 PG CL 10.9 M 5 X 20 Z. WHITE	VIS ISO 7380 CL 10.9 M 5 X 20 GALVANISATION BLANCHE	SCHRAUBE	TORNILLO
BV362	BV036200	NR	VITE TSPEI PG DIN 7991 CL 10.9 M 6 X 35 Z.BIANCA	SCREW DIN 7991 CL 10.9 M 6 X 35 Z. WHITE			
BV363	BV036300	NR	VITE TC CROCE PG DIN 7985 CL 4.8 M 6 X 12 Z.BIANCA	CROSS HEAD SCREW DIN 7985 PG CL 4.8 M 6 X 12 Z. WHITE	VIS DIN 7985 CL 4.8 M 6 X 12 GALVANISATION BLANCHE	SCHRAUBE	TORNILLO
BV364	BV036400	NR	VITE TE PARZIALE FILETTO PG DIN 931 CL 10.9 M 16 X 160	SCREW PARTIAL THREAD DIN 931 PG CL 10.9 M 16 X 160	VIS TE PARTIELLEMENT FILETÉE PG DIN 931 CL 10.9 M 16 X 60	TEILGEWINDESCHRAUBE DIN 931 PG CL 10.9 M 16 X 160	TORNILLO PARCIALMENTE ROSCADO PG DIN 931 CL 10.9 M 16 X 160

POS	Codice	U.M.	 Descrizione	 Description	 Designation	 Benennung	 Descripción
BV365	BV036500	NR	VITE TSPEI PG DIN 7991 CL 10.9 M 10 X 25 Z.BIANCA	TSPEI PG SCREW DIN 7991 CL 10.9 M 10 X 25 Z. WHITE	VIS DIN 7991 CL 10.9 M 10 X 25 GALVANISATION BLANCHE	SCHRAUBE	TORNILLO
BV366	BV036600	NR	VITE TE TUTTO FILETTO PF DIN 961 CL 8.8 M 20 X 1,5 X 35 Z.BIANCO	ALL SCREW TE THREAD DIN 961 CL 8.8 M 20 X 1.5 X 35 Z. WHITE	VIS	SCHRAUBE	TORNILLO
BV367	BV036700	NR	VITE TE PARZIALE FILETTO PG DIN 931 CL 10.9 M 16 X 120	SCREW PARTIAL THREAD DIN 931 PG CL 10.9 M 16 X 120	VIS PARTIELLEMENT FILETÉE DIN 931 CL 10.9 M 16 X 120	SCHRAUBE	TORNILLO
BV368	BV036800	NR	VITE TSPEI PG DIN 7991 CL 10.9 M 8 X 16 Z.BIANCA	SCREW DIN 7991 CL 10.9 M 8 X 16 Z. WHITE	VIS DIN 7991 CL 10.9 M 8 X 16 GALVANISATION BLANCHE		
BV369	BV036900	NR	VITE TE PARZIALE FILETTO PG DIN 931 CL 8.8 M 6 X 90 Z.BIANCA	SCREW THREAD DIN 931 PG CL 8.8 M 6 X 90 Z. WHITE	VIS FILETÉE DIN 931 CL 8.8 M 6 X 90 GALVANISÉE BLANCHE	VOLLGEWINDESCHRAUBE DIN 931 PG CL 8.8 M 6 X 90 Z. WEIß	TORNILLO ROSCADO DIN 931 CL 8.8 M 6 X 90 GALVANIZADO BLANCO
BV370	BV037000	NR	VITE TBEI PG ISO 7380 CL 10.9 M 8 X 30 Z.BIANCA	HEX SOCKET SCREW ISO 7380 PG CL 10.9 M 8 X 30 Z. WHITE	VIS ISO 7380 PG CL 10.9 M 8 X 30 Z. BLANC	TBEI PG SCHRAUBE ISO 7380 CL 10.9 M 8 X 30 Z. WEIß	TORNILLO TBEI PG ISO 7380 CL 10.9 M 8 X 30 GALVANIZADO BLANCO
BV371	BV037100	NR	VITE TE TUTTO FILETTO PG DIN 933 CL 8.8 M 5 X 30 Z.BIANCA	SCREW ALL THREAD DIN 933 PG CL 8.8 M 5 X 30 Z. WHITE	VIS TE ENTIÈREMENT FILETÉE PG DIN 933 CL 8.8 M 5 X 30 Z.BLANC	VOLLGEWINDESCHRAUBE DIN 933 PG CL 8.8 M 5 X 30 Z. WEIß	TORNILLO TOTALMENTE ROSCADO PG DIN 933 CL 8.8 M 5 X 30 GALVANIZADO BLANCO
BV372	BV037200	NR	VITE TE TUTTO FILETTO PG DIN 933 CL 8.8 M 5 X 35 Z.BIANCA	SCREW ALL THREAD DIN 933 PG CL 8.8 M 5 X 35 Z. WHITE	VIS TE ENTIÈREMENT FILETÉE PG DIN 933 CL 8.8 M 5 X 35 Z.BLANC	VOLLGEWINDESCHRAUBE DIN 933 PG CL 8.8 M 5 X 35 Z. WEIß	TORNILLO TOTALMENTE ROSCADO PG DIN 933 CL 8.8 M 5 X 35 GALVANIZADO BLANCO
BV373	BV037300	NR	VITE TSPEI PG DIN 7991 CL 10.9 M 5 X 10 Z.BIANCA	TSPEI PG SCREW DIN 7991 CL 10.9 M 5 X 10 Z. WHITE	VIS DIN 7991 CL 10.9 M 5 X 10 GALVANISATION BLANCHE	SCHRAUBE	TORNILLO
BV374	BV037400	NR	VITE TE TUTTO FILETTO PG DIN 931 CL 8.8 M 20 X 130 Z.BIANCA	SCREW THREAD DIN 931 PG CL 8.8 M 20 X 130	VIS FILETÉE DIN 931 CL 8.8 M 20 X 130	SCHRAUBE	TORNILLO
BV375	BV037500	NR	VITE TSPEI PG DIN 7991 CL 10.9 M 8 X 120 Z.BIANCA	SCREW DIN 7991 CL 10.9 M 8 X 120 Z. WHITE	VIS DIN 7991 CL 10.9 M 8 X 120 GALVANISATION BLANCHE		
BV376	BV037600	NR	VITE TCEI PARZIALE FILETTO PG DIN 912 CL 8.8 M 6 X 65 Z.BIANCA	SCREW DIN 912 M6 X 65 CL 8.8 Z. WHITE	VIS DIN 912 CL 8.8 M 6 X 65 GALVANISATION BLANCHE	SCHRAUBE	TORNILLO







Viteria













Fasteners











POS	Codice	U.M.	Descrizione	Description	Designation	Benennung	Descripción
BV377	BV037700	NR	VITE TCEI PARZIALE FILETTO PG DIN 912 CL 8.8 M 6 X 85 Z.BIANCA	SCREW DIN 912 M6 X 85 CL 8.8 Z. WHITE	VIS DIN 912 CL 8.8 M 6 X 85 GALVANISATION BLANCHE	SCHRAUBE	TORNILLO
BV378	BV037800	NR	VITE TE TUTTO FILETTO PG DIN 933 INOX A2 M 4 X 25	SCREW ALL THREAD DIN 933 PG CL 8.8 M 4 X 25 INOX	VIS ENTièrement FILETÉE DIN 933 CL 8.8 M 4 X 25 INOX	SCHRAUBE	TORNILLO
BV379	BV037900	NR	VITE TBEI PG ISO 7380 CL 10.9 M 5 X 10 Z.BIANCA	HEX SOCKET SCREW ISO 7380 PG CL 10.9 M 5 X 10 Z. WHITE	VIS ISO 7380 CL 10.9 M 5 X 10 GALVANISATION BLANCHE	SCHRAUBE	TORNILLO





POS	Codice	U.M.	 Descrizione	 Description	 Designation	 Benennung	 Descripción
RB1	RB000100	NR	DADO PER OGIVA Ø=12	NUT FOR OGIVA Ø = 12	ÉCROU POUR OGIVE Ø=12	SCHRAUBENMUTTER FÜR OGIVA Ø = 12	TUERCA PARA OJIVA Ø=12
RD1	RD000100	NR	RACCORDO CORPO A "T" EO F(DKOL)-M-M 8L	FITTING BODY A "T" EO F (DKOL) M-M-8L	RACCORD CORP "T" EO F (DKOL) M-M-8L	T-ANSCHLUSSSTÜCK EO F (DKOL) M-M-8L	UNIÓN EN "T" EO F(DKOL)-M-M 8L
RD2	RD000200	NR	RACCORDO CORPO A "T" EO F(DKOL)-M-M 10L	FITTING BODY A "T" EO F (DKOL) M-M-10L	RACCORD EN "T" EO F(DKOL)-M-M 10L	ANSCHLUSS	CONEXION
RD3	RD000300	NR	RACCORDO CORPO A "T" EO F(DKOL)-M-M 12L	FITTING BODY A "T" EO F (DKOL) M-M-12L	RACCORD CORP "T" EO F(DKOL)-M-M 12L	T-ANSCHLUSSSTÜCK EO F (DKOL) M-M-12L	UNIÓN EN "T" EO F(DKOL)-M-M 12L
RD4	RD000400	NR	RACCORDO CORPO A "T" EO F(DKOL)-M-M 15L	FITTING BODY A "T" EO F (DKOL) M-M-15L	RACCORD CORPS EN "T" EO F(DKOL)-M-M 15L	T-ANSCHLUSSSTÜCK EO F (DKOL) M-M-15L	UNIÓN EN "T" EO F(DKOL)-M-M 15L
RD5	RD000500	NR	RACCORDO CORPO A "T" EO M-F(DKOL)-M 10L	FITTING BODY A "T" EO M-F (DKOL) M-10L	RACCORD CORPS EN "T" EO M-F (DKOL) M-10L	T-ANSCHLUSSSTÜCK EO M-F (DKOL) M-10L	UNIÓN EN "T" EO M-F(DKOL)-M 10L
RD6	RD000600	NR	RACCORDO CORPO A "T" EO M-F(DKOL)-M 12L	FITTING BODY A "T" EO M-F (DKOL) M-12L	RACCORD EN "T" EO M-F(DKOL)-M 12L	ANSCHLUSS	CONEXION
RD7	RD000700	NR	RACCORDO CORPO A "T" EO 8L M 14*1.5	FITTING BODY A "T" EO 8L M 14 * 1.5	RACCORD EN "T" EO 8L M 14*1.5	ANSCHLUSS	CONEXION
RD8	RD000800	NR	RACCORDO CORPO A "T" EO 10L M 16*1.5	FITTING BODY A "T" M 10L EO 16 * 1.5	RACCORD EN "T" EO 10L M 16*1.5	ANSCHLUSS	CONEXION
RD9	RD000900	NR	RACCORDO CORPO A "T" EO 28L M 36*2	FITTING BODY A "T" M 28L EO 36 * 2	RACCORD CORPS EN "T" M 28L EO 36 * 2	T-ANSCHLUSSSTÜCK M 28L EO 36 * 2	UNIÓN EN "T" EO 28L M 36*2
RD10	RD001000	NR	RACCORDO CORPO A "T" EO 28L M 36*2	FITTING BODY A "T" EO M-F (DKOL) M-10L	RACCORD CORPS EN "T" EO M-F (DKOL) M-10L	T-ANSCHLUSSSTÜCK EO M-F (DKOL) M-10L	UNIÓN EN "T" EO 28L M 36*2
RD11	RD001100	NR	RACCORDO CORPO A "T" EO M-F(DKOL)-M 10L	FITTING BODY A "T" EO M-F (DKOL) M-10L	RACCORD CORP EN "T" EO 28L M 36*2	T-ANSCHLUSSSTÜCK EO M-F (DKOL) M-10L	CUERPO EN "T" CODO EO M-F(DKOL)-M 10L
RD12	RD001200	NR	ADATTATORE "T" GAS M-FG-M 1/4 1/4 1/4	ADAPTOR	ADAPTATEUR	ADAPTER	ADAPTADOR
RG1	RG000100	NR	RACCORDO CORPO A GOMITO 10L MASCH.-FEMM. DKOL	ELBOW FITTING BODY 10L MASCH.-FEMM. DKOL	RACCORD CORPS À GENOUILLÈRE 10L MASCH.-FEMM. DKOL	WINKELSTÜCK	UNIÓN EN CODO 10L MACHO-HEMBRA DKOL
RG2	RG000200	NR	RACCORDO CORPO A GOMITO 12L MASCH.-FEMM. DKOL	ELBOW FITTING BODY 12L MASCH.-FEMM. DKOL	RACCORD COUDÉ 12L MÂLE-FEMELLE DKOL	ANSCHLUSS	CONEXION





POS	Codice	U.M.	 Descrizione	 Description	 Designation	 Benennung	 Descripción
RG3	RG000300	NR	RACCORDO CORPO A GOMITO 20S MASCHIO-FEMMINA DKOS	20S BODY FITTING ELBOW MALE-FEMALE DKOS	RACCORD À GENOUILLE 20S MÂLE-FEMELLE DKOS	WINKELSTÜCK 20S STIFT- BUCHSE DKOS	UNIÓN EN CODO 20S MACHO- HEMBRA DKOS
RG4	RG000400	NR	RACCORDO CORPO A GOMITO 28L MASCHIO-FEMMINA DKOL	28L BODY FITTING ELBOW MALE-FEMALE DKOL	RACCORD CORPS À GENOUILLE MÂLE-FEMELLE DKOL	WINKELSTÜCK 28L STIFT- BUCHSE DKOL	UNIÓN EN CODO 28L MACHO- HEMBRA DKOL
RG5	RG000500	NR	RACCORDO A L MASCHIO- FEMMINA 1/8	BODY 90 ° M / F 1/8 "			
RG6	RG000600	NR	ADATTATORE 90° BSPP M-FG 1/4	ADAPTOR	ADAPTATEUR	ADAPTER	ADAPTADOR
RN1	RN000100	NR	RACCORDO CORPO D'ESTREMITA' TENUTA ED 8L * 3/8 GAS *K*	END FITTING WITH SEAL ED 8L * 3/8 GAS * K *	RACCORD CORPS D'EXTRÉMITÉ AVEC JOINT ED 8L * 3/8 GAS *K*	ANSCHLUSSSTÜCK MIT DICHTUNG ED 8L * 3/8 GAS * K *	UNIÓN CON JUNTA ED 8L * 3/8 GAS *K*
RN2	RN000200	NR	RACCORDO CORPO D'ESTREMITA' TENUTA ED 12L * 3/8 GAS *K*	END FITTING WITH SEAL ED 12L * 3/8 GAS * K *	RACCORD CORPS D'EXTRÉMITÉ AVEC JOINT ED12L * 3/8 GAS *K*	ANSCHLUSSSTÜCK MIT DICHTUNG ED 12L * 3/8 GAS * K *	UNIÓN CON JUNTA ED 12L * 3/8 GAS *K*
RN3	RN000300	NR	RACCORDO CORPO D'ESTREMITA' TENUTA ED 10L * 3/8 GAS *K*	FITTING END OF BODY 'AND SEAL 10L * 3/8 GAS * K *	RACCORD D'EXTRÉMITÉ AVEC JOINT D'ÉTANCHÉITÉ 10L * 3/8 GAS *K*	ANSCHLUSS	CONEXION
RN4	RN000400	NR	RACCORDO CORPO D'ESTREMITA' TENUTA ED 8L * 1/4 GAS *K*	END FITTING WITH SEAL ED 8L * 1/4 GAS * K *	RACCORD CORPS D'EXTRÉMITÉ AVEC JOINT ED 8L * 1/4 GAS *K*	ANSCHLUSSSTÜCK MIT DICHTUNG ED 8L * 1/4 GAS * K *	UNIÓN CON JUNTA ED 8L * 1/4 GAS *K*
RN5	RN000500	NR	RACCORDO CORPO D'ESTREMITA' TENUTA ED 10L * 1/4 GAS *K*	FITTING END OF BODY 'AND SEAL 10L * 1/4 GAS * K *	RACCORD D'EXTRÉMITÉ AVEC JOINT D'ÉTANCHÉITÉ 10L * 1/4 GAS *K*	ANSCHLUSS	CONEXION
RN6	RN000600	NR	RACCORDO CORPO D'ESTREMITA' TENUTA ED 12L * 1/4 GAS	FITTING END OF BODY 'AND SEAL 12L * 1/4 GAS	RACCORD	ANSCHLUSS	CONEXION
RN7	RN000700	NR	RACCORDO NIPLES GAS CON.- GAS CON. 1/4" * 1/4"	FITTING	RACCORD	ANSCHLUSS	RACORD
RN8	RN000800	NR	RACCORDO CORPO D'ESTREMITA' TENUTA ED 15L * 1/2 GAS *K*	END FITTING WITH SEAL ED 15L * 1/2 * K * GAS	RACCORD CORPS D'EXTRÉMITÉ AVEC JOINT ED 15L * 1/2 GAS *K*	ANSCHLUSSSTÜCK MIT DICHTUNG ED 15L * 1/2 GAS *K*	UNIÓN CON JUNTA ED 15L * 1/2 GAS *K*

POS	Codice	U.M.	 Descrizione	 Description	 Designation	 Benennung	 Descripción
RN9	RN000900	NR	RACCORDO CORPO D'ESTREMITA' TENUTA ED 10L * 1/2 GAS *K*	FITTING END OF BODY 'AND SEAL 10L * 1/2 * K * GAS	RACCORD	ANSCHLUSS	CONEXION
RN10	RN001000	NR	RACCORDO CORPO D'ESTREMITA' TENUTA ED 15L * 3/4 GAS *K*	END FITTING WITH SEAL ED 15L * 3/4 GAS * K *	RACCORD CORPS D'EXTRÉMITÉ AVEC JOINT ED 15L * 3/4 GAS * K *	ANSCHLUSSSTÜCK MIT DICHTUNG ED 15L * 3/4 GAS *K*	UNIÓN CON JUNTA ED 15L * 3/4 GAS *K*
RN11	RN001100	NR	RACCORDO CORPO D'ESTREMITA' TENUTA ED 12L * 1/2 GAS *K*	END FITTING WITH SEAL ED 12L * 1/2 GAS * K *	RACCORD CORPS D'EXTRÉMITÉ AVEC JOINT ED 12L * 1/2 GAS *K*	ANSCHLUSSSTÜCK MIT DICHTUNG ED 12L * 1/2 GAS *K*	UNIÓN CON JUNTA ED 12L * 1/2 GAS *K*
RN12	RN001200	NR	RACCORDO CORPO D'ESTR. TENUTA ED 8L * 1/2 GAS	END FITTING WITH SEAL ED 8L * 1/2 GAS	RACCORD CORP D'EXTRÉMITÉ AVEC JOINT ED 8L * 1/2 GAS	ANSCHLUSSSTÜCK MIT DICHTUNG ED 8L * 1/2 GAS	UNIÓN CON JUNTA ED 8L * 1/2 GAS
RN13	RN001300	NR	RACCORDO CORPO D'ESTR. TENUTA ED 8L * 3/4 GAS	CONNECTOR BODY OF EXTR. SEAL AND 8L * 3/4 GAS	RACCORD	ANSCHLUSS	CONEXION
RN14	RN001400	NR	RACCORDO CORPO D'ESTR. TENUTA ED 12L * 3/4 GAS	CONNECTOR BODY OF EXTR. SEAL AND 12L * 3/4 GAS	RACCORD	ANSCHLUSS	CONEXION
RN15	RN001500	NR	RACCORDO CORPO D'ESTR.TENUTA ED 15L * 3/8 GAS	END FITTING WITH SEAL ED 15L * 3/8 GAS	RACCORD CORPS D'EXTRÉMITÉ AVEC JOINT ED 15L * 3/8 GAS	ANSCHLUSSSTÜCK MIT DICHTUNG ED 15L * 3/8 GAS	UNIÓN CON JUNTA ED 15L * 3/8 GAS
RN16	RN001600	NR	RACCORDO CORPO D'ESTR.TENUTA ED 22L * 3/4 GAS	END FITTING WITH SEAL ED 22L * 3/4 GAS	RACCORD CORP D'EXTRÉMITÉ AVEC JOINT ED 22L * 3/4 GAS	ANSCHLUSSSTÜCK MIT DICHTUNG ED 22L * 3/4 GAS	UNIÓN CON JUNTA ED 22L * 3/4 GAS
RN17	RN001700	NR	RACCORDO CORPO D'ESTR. TENUTA ED 28L * 3/4" GAS	END FITTING WITH SEAL ED 28L * 3/4 BSP	RACCORD CORPS D'EXTRÉMITÉ AVEC JOINT ED 28L * 3/4 BSP	ANSCHLUSSSTÜCK MIT DICHTUNG ED 28L * 3/4" GAS	UNIÓN CON JUNTA ED 28L * 3/4" GAS
RN18	RN001800	NR	RACCORDO CORPO D'ESTR. TENUTA ED 20S * 3/4 GAS	CONNECTOR BODY OF EXTR. SEAL AND 20S * 3/4 GAS	RACCORD	ANSCHLUSS	CONEXION
RN19	RN001900	NR	RACCORDO CORPO D'ESTREMITA' 8L * M 12X1.5 ED	END FITTING 8L * M 12X1.5 ED	RACCORD CORPS D'EXTRÉMITÉ 8L * M 12X1.5 ED	ANSCHLUSSSTÜCK 8L * M 12X1.5 ED	UNIÓN 8L * M 12X1.5 ED
RN20	RN002000	NR	RACCORDO CORPO D'ESTREMITA' 8L * M 14X1.5 ED	FITTING END OF BODY 'AND 8L * M 14X1.5	RACCORD	ANSCHLUSS	CONEXION

POS	Codice	U.M.	 Descrizione	 Description	 Designation	 Benennung	 Descripción
RN21	RN002100	NR	RACCORDO CORPO D'ESTREMITA' 10L * M 18X1.5 ED	END FITTING 10L * M 18X1.5	RACCORD CORPS D'EXTRÉMITÉ 10L * M 18X1.5 ED	ANSCHLUSSSTÜCK 10L * M 18X1.5 ED	UNIÓN 10L * M 18X1.5 ED
RN22	RN002200	NR	RACCORDO CORPO D'ESTR. TENUTA ED 15L * M 18X1.5	CONNECTOR BODY OF EXTR. SEAL AND 15L * M 18X1.5	RACCORD	ANSCHLUSS	CONEXION
RN23	RN002300	NR	RACCORDO CORPO D'ESTR. TENUTA ED 15L * M 22X1.5	END FITTING WITH SEAL ED 15L * M 22X1.5	RACCORD CORPS D'EXTRÉMITÉ AVEC JOINT ED 15L * M 22X1.5	ANSCHLUSSSTÜCK MIT DICHTUNG ED 15L * M 22X1.5	UNIÓN CON JUNTA ED 15L * M 22X1.5
RN24	RN002400	NR	RACCORDO CORPO D'ESTR. TENUTA ED 22L * M26X1.5	CONNECTOR BODY OF EXTR. SEAL AND 22L * M26X1.5	RACCORD	ANSCHLUSS	CONEXION
RN25	RN002500	NR	RACCORDO CORPO D'ESTR. TENUTA ED 20S * M27X2	CONNECTOR BODY OF EXTR. SEAL AND 20S * M27X2	RACCORD	ANSCHLUSS	CONEXION
RN26	RN002600	NR	RACCORDO CORPO D'ESTR. 8L * 9/16-18 UNF-2A	END FITTING 8L * 9/16-18 UNF-2A	RACCORD CORPS D'EXTRÉMITÉ 8L * 9/16-18 UNF-2A	ANSCHLUSSSTÜCK 8L * 9/16-18 UNF-2A	UNIÓN 8L * 9/16-18 UNF-2A
RN27	RN002700	NR	RACCORDO CORPO D'ESTR. 12L * 3/4 -16 UNF-2A	END FITTING 12L * 3/4 -16 UNF-2A	RACCORD CORPS D'EXTRÉMITÉ 12L * 3/4 -16 UNF-2A	ANSCHLUSSSTÜCK 12L * 3/4 -16 UNF-2A	UNIÓN 12L * 3/4 -16 UNF-2A
RN28	RN002800	NR	RACCORDO CORPO D'ESTR. 20S * 1.5/16 -12 UN-2A	END FITTING 20S * 1.5/16 -12 UN-2A	RACCORD CORPS D'EXTRÉMITÉ 20S * 1.5/16 -12 UN-2A	ANSCHLUSSSTÜCK 20S * 1.5/16 -12 UN-2A	UNIÓN 20S * 1.5/16 -12 UN-2A
RN29	RN002900	NR	RACCORDO CORPO D'ESTR. TENUTA ED 22L * M26X1.5	END FITTING WITH SEAL ED 22L * M26X1.5	RACCORD CORPS D'EXTRÉMITÉ AVEC JOINT ED 22L * M26X1.5	ANSCHLUSSSTÜCK MIT DICHTUNG ED 22L * M26X1.5	UNIÓN CON JUNTA 22L * M26X1.5
RN30	RN003000	NR	RACCORDO CORPO D'ESTR. TENUTA ED 22L * M26X1.5	END FITTING WITH SEAL ED 22L * M26X1.5	RACCORD CORPS D'EXTRÉMITÉ AVEC JOINT ED 22L * M26X1.5	ANSCHLUSSSTÜCK MIT DICHTUNG ED 22L * M26X1.5	UNIÓN CON JUNTA ED 22L * M26X1.5
RN31	RN003100	NR	RACCORDO CORPO D'ESTREMITA' TENUTA ED 6L * 1/4 GAS *K*	END FITTING WITH SEAL 1/4 BSPP 6L	RACCORD CORPS D'EXTRÉMITÉ AVEC JOINT 1/4 BSPP 6L	ANSCHLUSSSTÜCK MIT DICHTUNG 1/4 BSPP 6L	UNIÓN CON JUNTA 1/4 BSPP 6L
RN32	RN003200	NR	RACCORDO CORPO D'ESTREMITA' TENUTA ED 8L * 3/8 GAS *K*	END FITTING WITH SEAL ED 8L * 3/8 GAS * K *	RACCORD CORPS D'EXTRÉMITÉ AVEC JOINT ED 8L * 3/8 GAS *K*	ANSCHLUSSSTÜCK MIT DICHTUNG ED 8L * 3/8 GAS * K *	UNIÓN CON JUNTA ED 8L * 3/8 GAS *K*

POS	Codice	U.M.	 Descrizione	 Description	 Designation	 Benennung	 Descripción
RN33	RN003300	NR	NIPPLES 1/8" JIS 1/8"GAS	CAP	CAPUCHON	NIPPEL	CAPUCHO
RN34	RN003400	NR	NIPPLES 1/4" JIS 1/4"GAS	CAP	CAPUCHON	NIPPEL	CAPUCHO
RN35	RN003500	NR	NIPPLES 3/8" JIS 1/4"GAS	CAP	CAPUCHON	NIPPEL	CAPUCHO
RN36	RN003600	NR	NIPPLES 3/8" JIS 1/4"GAS	CAP	CAPUCHON	NIPPEL	CAPUCHO
RO1	RO000100	NR	OGIVA PER TUBO Ø=12	OGIVE FOR TUBE Ø = 12	OGIVE POUR TUYAU Ø = 12	OGIVE FÜR ROHR Ø = 12	OJIVA PARA TUBO Ø=12
RR1	RR000100	NR	RONDELLA RAME 1/4	COPPER WASHER 1/4	RONDELLE	SCHEIBE	ARANDELA
RR2	RR000200	NR	RONDELLA BONDED GAS 3/8" *K*	BONDED WASHER GAS 3/8 " * K *	RONDELLE	SCHEIBE	ARANDELA
RR3	RR000300	NR	RONDELLA BONDED METRICA 12 *K*	METRIC BONDED WASHER 12 * K *	RONDELLE BONDED MÉTRIQUE 12 *K*	BONDED UNTERLEGSCHIEBE 12 * K *	ARANDELA BONDED MÉTRICA 12 *K*
RR4	RR000400	NR	RONDELLA BONDED GAS 1/4" *K*	BONDED WASHER GAS 1/4 " * K *	RONDELLE		
RR5	RR000500	NR	RONDELLA BONDED GAS 1/2" *K*	BONDED WASHER GAS 1/2 " * K *	RONDELLE BONDED GAS 1/2" *K*	BONDED UNTERLEGSCHIEBE GAS 1/2" *K*	ARANDELA BONDED GAS 1/2" *K*
RR6	RR000600	NR	RONDELLA RAME 3/8	COPPER WASHER 3/8	RONDELLE	SCHEIBE	ARANDELA
RR7	RR000700	NR	RONDELLA BONDED GAS 1/8" *K*	BONDED WASHER GAS 1/8 " * K *	RONDELLE	SCHEIBE	ARANDELA
RR8	RR000800	NR	RONDELLA BONDED GAS 1" *K*	BONDED WASHER GAS 1 " * K *	RONDELLE BONDED GAS 1" *K*	BONDED UNTERLEGSCHIEBE GAS 1" *K*	ARANDELA BONDED GAS 1" *K*
RR9	RR000900	NR	RONDELLA BONDED GAS 3/4" *K*	BONDED WASHER GAS 3/4 " * K *	RONDELLE BONDED GAS 3/4" *K*	BONDED UNTERLEGSCHIEBE GAS 3/4" *K*	ARANDELA BONDED GAS 3/4" *K*
RR10	RR001000	NR	RONDELLA BONDED GAS 1.1/4"	BONDED WASHER GAS 1.1 / 4 "	RONDELLE	SCHEIBE	ARANDELA
RR11	RR001100	NR	RONDELLA RAME M10	COPPER WASHER M10	RONDELLE	SCHEIBE	ARANDELA
RR12	RR001200	NR	RONDELLA RAME 1/2	COPPER WASHER 1/2	RONDELLE	SCHEIBE	ARANDELA
RR13	RR001300	NR	RONDELLA BONDED M12	BONDED WASHER M12	RONDELLE	SCHEIBE	ARANDELA
RS1	RS000100	NR	COPPIA SEMIFLANGE SAE 6000 3/4"	PAIR 6000 SAE FLANGE HALVES 3/4 "	COUPLE SEMI-BRIDES SAE 6000 3/4"	SAE-HALBFLANSCHEN PAAR 6000 3/4"	PAREJA SEMIBRIDAS SAE 6000 3/4"

POS	Codice	U.M.	 Descrizione	 Description	 Designation	 Benennung	 Descripción
RS2	RS000200	NR	RACC.M 20S(M30X2) - ED M 1"5/16 UNF H=33	FITTING M 20S (M30X2) - ED M 1 "5/16 UNF H = 33	RACCORD M 20S(M30X2) - ED M 1"5/16 UNF H=33	ANSCHLUSSSTÜCK M 20S (M30X2) - ED M 1 "5/16 UNF H = 33	UNIÓN M 20S(M30X2) - ED M 1"5/16 UNF H=33
RS3	RS000300	NR	RIDUZIONE M-F GAS 1" * 1/2"	REDUCING GAS M-F 1 " * 1/2"	RÉDUCTION M-F GAS 1" * 1/2"	REDUKTION M-F GAS 1" * 1/2"	REDUCCIÓN M-F GAS 1" * 1/2"
RS4	RS000400	NR	RACCORDO COLONNETTA M15L - 3/8" GAS H=50	COLUMN CONNECTION M15L - 3/8 "GAS H = 50	RACCORD DOIGT M15L - 3/8 "GAS H = 50	ANSCHLUSS M15L - 3/8 "GAS H = 50	CODO M15L - 3/8" GAS H=50
RS5	RS000500	NR	RACCORDO COLONNETTA M15L - 3/8" GAS H=96	COLUMN CONNECTION M15L - 3/8 "GAS H = 96	RACCORD DOIGT M15L - 3/8" GAS H=96	ANSCHLUSS - 3/8 "GAS H = 96	CODO M15L - 3/8" GAS H=96
RS6	RS000600	NR	CODOLO M1/4" ED X FG 8L (M14X1.5)	FITTING M1 / 4 "X AND FG 8L (M14X1.5)	EMBOUT M1/4" ED X FG 8L (M14X1.5)	SCHAFT M1/4" ED X FG 8L (M14X1.5)	CODO M1/4" ED X FG 8L (M14X1.5)
RS7	RS000700	NR	RIDUZIONE M-F GAS 1" * 1/2"	REDUCING GAS M-F 1 " * 1/2"	RÉDUCTION M-F GAS 1" * 1/2"	REDUZIERUNG GAS M-F 1" * 1/2"	REDUCCIÓN M-F GAS 1" * 1/2"
RS8	RS000800	NR	RACCORDO CODOLO D' ESTR. FEM. DKO 12L*3/8 GAS ED	END FITTING FEM. DKO 12L*3/8 GAS ED	RACCORD FEM. DKO 12L*3/8 GAS ED	ANSCHLUSS FEM. DKO 12L*3/8 GAS ED	CONECTOR FEM. DKO 12L*3/8 GAS ED
RS9	RS000900	NR	MANICOTTO ARIA 1/8-1/8	AIR MANIFOLD 1/8-1/8			
RS10	RS001000	NR	RIDUZIONE M-F GAS 3/8" JIS 1/8" BSPP	REDUCING GAS M-F 3/8" JIS 1/8" BSPP	RÉDUCTION M-F GAS 3/8" JIS 1/8" BSPP	REDUZIERUNG GAS M-F 3/8" JIS 1/8" BSPP	REDUCCIÓN M-F GAS 3/8" JIS 1/8" BSPP
RS11	RS001100	NR	RACCORDO M-M 15L	FITTING M-M 15L			
RS12	RS001200	NR	RACCORDO NIPLES GAS CON.- GAS CON.1/2"1/2"	FITTING 1/2" - 1/2"	RACCORD	ANSCHLUSS	RACORD
RT1	RT000100	NR	TAPPO MASCHIO TE GAS 3/8" SVASATO 60° *K*	SCREW EYE FOR GAS 1/2 "H = 50	BOUCHON	VERSCHLUSS	TAPA
RT2	RT000200	NR	TAPPO MASCHIO ESAGONO INTERNO GAS 1/4" SVASATO 60° *K*	MALE PLUG GAS INTERNAL HEX 1/4 "FLARE 60 ° * K *	BOUCHON MÂLE HEXAGONAL INTÉRIEUR GAS 1/4" ÉVASÉ 60° *K*	ZYLINDRISCHER STOPFEN	TAPÓN MACHO HEXÁGONO INTERNO GAS 1/4" SVASATO 60° *K*
RT3	RT000300	NR	TAPPO MASCHIO TE GAS 1/2" SVASATO 60° *K*	MALE PLUG TE GAS 1/2 "FLARE 60 ° * K *	BOUCHON MÂLE TE GAS 1/2" ÉVASÉ 60° *K*	STECKER TE GAS 1/2 "GESENKT 60 ° * K *	TAPÓN MACHO TE GAS 1/2" ABOCINADO 60° *K*
RT4	RT000400	NR	TAPPO MASCHIO TE GAS 1/4" SVASATO 60° *K*	MALE PLUG TE GAS 1/4 "FLARE 60 ° * K *	BOUCHON	VERSCHLUSS	TAPA
RT5	RT000500	NR	TAPPO MASCHIO ESAGONO INTERNO GAS 3/8" SVASATO 60° *K*	MALE PLUG GAS INTERNAL HEX 3/8 "FLARE 60 ° * K *	BOUCHON	VERSCHLUSS	TAPA

POS	Codice	U.M.	 Descrizione	 Description	 Designation	 Benennung	 Descripción
RT6	RT000600	NR	TAPPO MASCHIO ESAGONO INTERNO GAS 1" SVASATO 60° *K*	MALE PLUG GAS INTERNAL HEX 1 "FLARE 60 ° * K *	BOUCHON MÂLE HEXAGONAL INTÉRIEUR GAS 1" ÉVASÉ 60° *K*	ZYLINDRISCHER STOPFEN + DICHTUNG	TAPÓN MACHO HEXÁGONO INTERNO GAS 1" ABOCINADO 60° *K*
RT7	RT000700	NR	TAPPO MASCHIO TE GAS 1/8" SVASATO 60° *K*	MALE PLUG TE GAS 1/8 "FLARE 60 ° * K *	BOUCHON	VERSCHLUSS	TAPA
RT8	RT000800	NR	TAPPO MASCHIO TE GAS 1/4" JIS	MALE PLUG TE GAS 1/4 " JIS	BOUCHON	VERSCHLUSS	TAPA
RT9	RT000900	NR	TAPPOO FEMMINA COMPLETO 6L	COMPLETE 6L FEMALE CAP			
RT10	RT001000	NR	TAPPOO FEMMINA COMPLETO 8L	COMPLETE 8L FEMALE CAP	COUVERCLE	DECKEL	TAPA
RT11	RT001100	NR	TAPPO CILINDRICO TCEI+GUARNIZIONE GAS CI 5.8 3/4 Z.BIANCA	CYLINDRICAL SOCKET HEAD CAP + SEAL GAS CI 5.8 3/4 Z. WHITE	BOUCHON	VERSCHLUSS	TAPA
RT12	RT001200	NR	TAPPO CILINDRICO TCEI+GUARNIZIONE GAS CI 5.8 1/2 Z.BIANCA	CYLINDRICAL SOCKET HEAD CAP + SEAL GAS CI 5.8 1/2 Z. WHITE	BOUCHON	VERSCHLUSS	TAPA
RV1	RV000100	NR	VITE PER OCCHIO GAS 1/4" H=29 *K*	SCREW EYE FOR GAS 1/4 "H = 29 * K *	VIS	SCHRAUBE	TORNILLO
RV2	RV000200	NR	VITE PER OCCHIO DOPPIA GAS 3/8"	SCREW EYE DOUBLE FOR GAS 3/8 "	VIS	SCHRAUBE	TORNILLO
RV3	RV000300	NR	VITE PER OCCHIO GAS 1/2" H=50	SCREW EYE FOR GAS 1/2 "H = 50	VIS	SCHRAUBE	TORNILLO
RV4	RV000400	NR	VITE PER OCCHIO DOPPIA GAS 1/4"	DOUBLE EYE SCREW FOR GAS 1/4"	VIS DOUBLE À OEIL GAS 1/4"	DOPPEL-AUGENSCHRAUBE GAS 1/4"	TORNILLO DOBLE OJO GAS 1/4"
RV5	RV000500	NR	VITE PER OCCHIO GAS 3/8"	SCREW EYE FOR GAS 3/8"	VIS	SCHRAUBE	TORNILLO
RV6	RV000600	NR	VITE PER OCCHIO GAS 1/8"	SCREW EYE FOR GAS 1/8"	VIS	SCHRAUBE	TORNILLO

